

Ultrasonic Transducer

Operator's Manual

Contents







Contents	i
1 Overview	1-1
1.1 Safety Classification	1-1
1.2 Applications	1-1
1.3 Acoustic Power.....	1-1
1.4 Transducer/Needle-guided Bracket Model.....	1-1
1.5 Composition	1-21
1.6 Procedures for Operating the Transducer	1-26
2 Connecting the Transducer to the System	2-1
2.1 Connecting and Disconnecting the Transducer	2-1
3 Inspection Before and After Use	3-1
3.1 Check the External Appearance of the Transducer	3-1
3.2 Cleaning the Transducer	3-1
3.3 Checking after Turning on the System.....	3-1
4 Operating Procedures	4-1
4.1 Orientation of the Ultrasound Image and the Transducer Head	4-1
4.2 Utilizing the Transducer Sheath	4-2
4.3 When the Immersion Method is Used	4-3
4.4 Examinations.....	4-7
4.5 After Examinations	4-7
5 Cleaning and Disinfection	5-1
5.1 Cleaning	5-1
5.2 High Level Disinfections	5-2
5.3 Sterilization	5-3
6 Needle-guided Bracket and Biopsy	6-1
7 Storage and Transportation	7-1
8 Specifications	8-1

Intellectual Property Statement

SHENZHEN MINDRAY BIO-MEDICAL ELECTRONICS CO., LTD. (hereinafter called Mindray) owns the intellectual property rights to this Mindray product and this manual. This manual may refer to information protected by copyright or patents and does not convey any license under the patent rights or copyright of Mindray, or of others.

Mindray intends to maintain the contents of this manual as confidential information. Disclosure of the information in this manual in any manner whatsoever without the written permission of Mindray is strictly forbidden.

Release, amendment, reproduction, distribution, rental, adaptation, translation or any other derivative work of this manual in any manner whatsoever without the written permission of Mindray is strictly forbidden.

 ,  ,  ,  ,  ,  BeneView, WATO, BeneHeart,  are the trademarks, registered or otherwise, of Mindray in China and other countries. All other trademarks that appear in this manual are used only for informational or editorial purposes. They are the property of their respective owners.

Responsibility on the Manufacturer Party

Contents of this manual are subject to change without prior notice.

All information contained in this manual is believed to be correct. Mindray shall not be liable for errors contained herein or for incidental or consequential damages in connection with the furnishing, performance, or use of this manual.

Mindray is responsible for the effects on safety, reliability and performance of this product, only if:

- all installation operations, expansions, changes, modifications and repairs of this product are conducted by Mindray authorized personnel;
- the electrical installation of the relevant room complies with the applicable national and local requirements; and
- the product is used in accordance with the instructions for use.

Note

This equipment must be operated by skilled/trained clinical professionals.

Warning

It is important for the hospital or organization that employs this equipment to carry out a reasonable service/maintenance plan. Neglect of this may result in machine breakdown or personal injury.

Warranty

THIS WARRANTY IS EXCLUSIVE AND IS IN LIEU OF ALL OTHER WARRANTIES, EXPRESSED OR IMPLIED, INCLUDING WARRANTIES OF MERCHANTABILITY OR FITNESS FOR ANY PARTICULAR PURPOSE.

Exemptions

Mindray's obligation or liability under this warranty does not include any transportation or other charges or liability for direct, indirect or consequential damages or delay resulting from the improper use or application of the product or the use of parts or accessories not approved by Mindray or repairs by people other than Mindray authorized personnel.

This warranty shall not extend to:

- **Malfunction or damage caused by improper use or man-made failure.**
- **Malfunction or damage caused by unstable or out-of-range power input.**
- **Malfunction or damage caused by force majeure such as fire and earthquake.**
- **Malfunction or damage caused by improper operation or repair by unqualified or unauthorized service people.**
- **Malfunction of the instrument or part whose serial number is not legible enough.**
- **Others not caused by instrument or part itself.**

Company Contact

Manufacturer: Shenzhen Mindray Bio-Medical Electronics Co., Ltd.
Address: Mindray Building, Keji 12th Road South, High-tech industrial park, Nanshan, Shenzhen 518057, P.R.China
Website: www.mindray.com
E-mail Address: service@mindray.com
Tel: +86 755 81888998
Fax: +86 755 26582680

EC-Representative: Shanghai International Holding Corp. GmbH(Europe)
Address: Eiffestraße 80, Hamburg 20537, Germany
Tel: 0049-40-2513175
Fax: 0049-40-255726

Manufacturer: Mindray DS USA, Inc.
Address: 800 MacArthur Blvd.
Mahwah, NJ 07430-0619 USA
Tel: +1(201) 995-8000
Toll Free: +1 (800) 288-2121
Fax: +1 (800) 926-4275

Important Information

Responsibility on customers:

1. The responsibility for maintenance and management of the product after delivery resides with the customer who has purchased the product.
2. The warranty does not cover the following items, even during the warranty period:
 - (1) Damage or loss due to misuse or abuse.
 - (2) Damage or loss caused by Acts of God such as fires, earthquakes, floods, lightning, etc.
 - (3) Damage or loss caused by failure to meet the specified conditions for this system, such as inadequate power supply, improper installation or environmental conditions.
 - (4) Damage or loss due to use of the system outside the region where the system was originally sold.
 - (5) Damage or loss involving the system purchased from a source other than Mindray or its authorized agents.
3. This equipment shall not be used by persons other than fully qualified and certified medical personnel.
4. Do not make changes or modifications to the software or hardware of this product.
5. In no event shall MINDRAY be liable for problems, damage, or loss caused by relocation, modification, or repair performed by personnel other than those designated by MINDRAY.
6. The purpose of this system is to provide physicians with data for clinical diagnosis. The responsibility for diagnostic procedures lies with the physicians involved. MINDRAY shall not be liable for the results of diagnostic procedures.
7. MINDRAY shall not be liable for loss of data stored in the memory of this system caused by operator error or accidents.
8. This manual contains Warnings regarding foreseeable potential dangers. Be alert at all times to dangers other than those indicated. MINDRAY shall not be liable for damage or loss that results from negligence or from ignoring the precautions and operating instructions contained in this operator's manual.
9. On the occasion of change of the administrator or manager for this system, be sure to hand over this operator's manual.
10. When disposing of this system, contact your MINDRAY Customer Service Department or sales representative. Do not dispose of this system without consulting MINDRAY Customer Service Department or sales representative first. MINDRAY does not assume any responsibility for damage resulting from disposal of this system without consulting MINDRAY.

Introduction



This operator's manual describes the operating procedure for the transducers. To ensure safe and correct operation of the transducer, read the operator's manual carefully and understand the transducers clearly before operation.

For the operating procedures for the ultrasonic diagnostic system and other devices, please refer to the relevant manuals.

Safety Precautions

Meaning of Signal Words

In this operator's manual,  **DANGER**,  **WARNING**,  **CAUTION** and **NOTE** are signal words used to indicate safety and other important instructions. The signal words and their meanings are defined as follows. Please understand their meanings clearly before reading this manual.

Signal Word	Meaning
 DANGER	Indicates an imminently hazardous situation that, if not avoided, will result in death or serious injury.
 WARNING	Indicates a potentially hazardous situation that, if not avoided, could result in death or serious injury.
 CAUTION	Indicates a potentially hazardous situation that, if not avoided, may result in minor or moderate injury.
NOTE	Indicates a potentially hazardous situation that, if not avoided, may result in property damage.

Meaning of Safety Symbols

Symbol	Description
	General warning, caution, risk of danger.

Safety Precautions

Please read the following precautions carefully to ensure the safety of the patient and the operator when using this transducer.

 **DANGER:** DO NOT use flammable gasses, such as anesthetic gas or hydrogen, or flammable liquids such as ethanol, near the product, because there is danger of explosion.

 **WARNING:**

1. Confirm that the transducer and cable are normal before and after each examination. A defective transducer may cause electric shock to the patient.
2. Do not subject the transducer to shock. A defective transducer may cause electric shock to the patient.

3. Do not disassemble the transducer to avoid the possibility of electric shock.
4. Never immerse the transducer connector into liquids such as water or disinfectant because the connector is not waterproof. Immersion may cause electric shock or malfunction.
5. The ultrasonic transducer is only for use with the specified ultrasonic diagnostic system. Please refer the ultrasonic diagnostic system operation manual to select the proper transducer.
6. A transducer sheath must be installed over the transducer before performing examination.
7. Do not use an aftermarket probe other than those specified by Mindray. The probes may damage the system causing a profound failure, e.g. a fire in the worst case.

 **CAUTION:**

1. When using the transducer, wear sterile gloves to prevent infection.
2. Be sure to use ultrasound gel. Please use the ultrasound gel compliant with the relevant local regulations.
3. In normal diagnostic ultrasound mode, there is no danger of a low-temperature burn; however, keeping the transducer on the same region of the patient for a long time may cause such a burn.
4. Do not use the carrying case for storing the transducer. If the carrying case is used for storage, it may become a source of infection.
5. The transducer and accessories supplied with it are not delivered disinfected or sterilized. Sterilization (or high-level disinfect) before use is required.
6. It is required to practice ALARA when operating ultrasound system. Minimize the acoustic power without compromising the quality of images.
7. Disposable components are packaged sterile and are single-use only. Do not use if integrity of packaging violated or if expiration date has passed. Please use the disposable components compliant with the relevant local regulations.
8. Please use the disinfection or sterilization solution that recommended in this operator's manual, otherwise Mindray will not be liable for damage caused by other solutions. If you have any questions, please contact Mindray Customer Service Department or sales representative.
9. Do not use pre-lubricated condoms as a sheath. Lubricant may not be compatible with the transducer material and damage may result.

10. Transducer damage may be caused by inappropriate gel, detergent or cleanser:

Do not soak or saturate transducers with solutions containing alcohol, bleach, ammonium chloride compounds, acetone or formaldehyde.

Avoid contact with solutions or coupling gels containing mineral oil or lanolin.

NOTE:

1. Read the following precautions to prevent the transducer from malfunction.
 - Before connecting or disconnecting the transducer, freeze or turn off the ultrasonic diagnostic system.
 - Clean and disinfect the transducer before and after each examination.
2. Ambient conditions:

To prevent the transducer from being damaged, do not use it where it will be exposed to:

 - direct sunlight or X-rays
 - sudden changes in temperature
 - dust
 - excessive vibration
 - heat generators



Use the transducer under the specified ambient conditions, for details; please refer to "8 Specifications".
3. Repeated disinfection will eventually damage the transducer, please check the transducer's performance periodically.

Labels

Various labels are attached to the device in order to call the user's attention.

This operator's manual describes the safety precautions of operating the transducer. Read the operator's manual carefully before using the system.

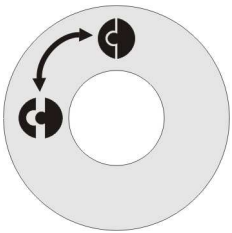
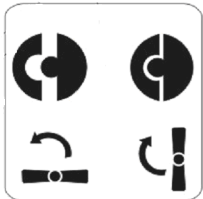
Some labels are shown in the following.

No.	Label	Meaning
1		<p>Indicates the direction of the lock handle. The top symbol indicates the position of locked handle, the left symbol indicates the position of the unlocked handle.</p> <p>This label is found on Doppler ultrasound system transducers and on black and white ultrasound 128-element transducers.</p>
2		<p>Indicates the direction of the lock handle. The left symbol indicates the position of the unlocked status; the right symbol indicates the position of the locked status. .</p> <p>This label is found on black and white ultrasound 80-element transducers.</p>
3		<p>Type-BF applied part.</p>
4		<p>General warning sign.</p>

1 Overview

1.1 Safety Classification

Please refer to the safety classification information in the related operator's manual for the ultrasonic diagnostic system that matches with the transducer.

1.2 Applications

Please check the operator's manual for the ultrasonic diagnostic system to check the compatibility of the transducer.

For the intended use, please refer to the operator's manuals of the corresponding diagnostic ultrasound system.

1.3 Acoustic Power



The effects of acoustic power on human tissue are currently under investigation. Therefore, it is recommended that diagnostic ultrasound output power be set to the lowest possible levels in accordance with the ALARA (As Low As Reasonably Achievable) principle.

Please refer to the operator's manual of the ultrasonic diagnostic system.

1.4 Transducer/Needle-guided Bracket Model

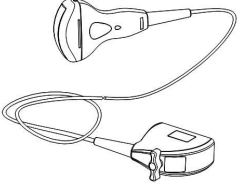
1.4.1 Transducer Model

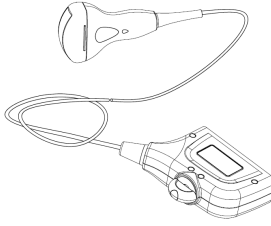
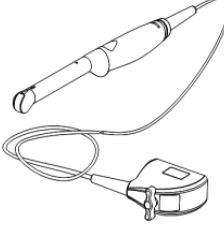
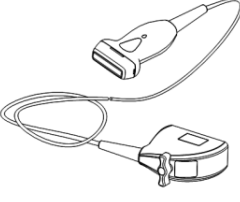
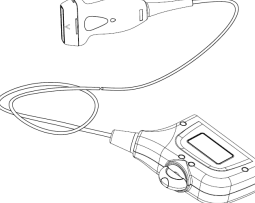
No.	Model	Type	Applied region	Illustration
1.	35C50EB	Convex	Body surface	

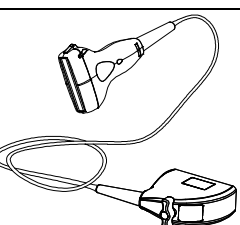
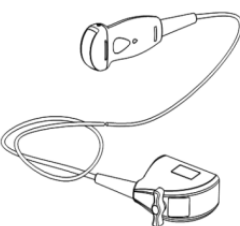
No.	Model	Type	Applied region	Illustration
2.	35C50P	Convex	Body surface	
3.	65EC10EB	Convex (intracavitary)	Transrectal, transvaginal	
4.	75L38EB	Linear	Body surface	
5.	75L38P	Linear	Body surface	
6.	65C15EA	Convex	Body surface	
7.	75L60EA	Linear	Body surface	
8.	35C20EA	Convex	Body surface	

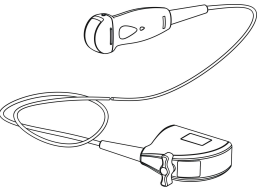
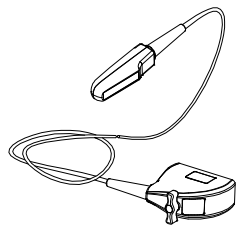
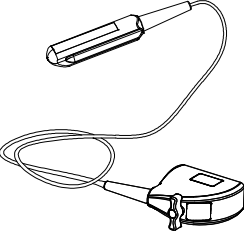
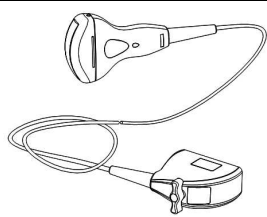
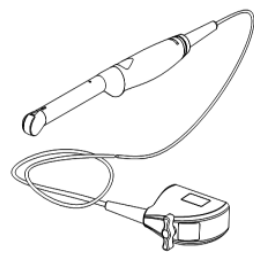
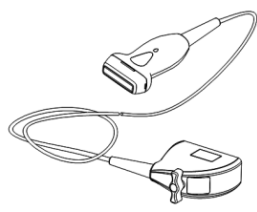
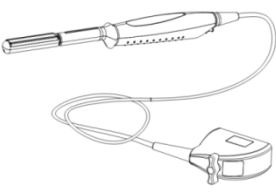
No.	Model	Type	Applied region	Illustration
9.	65C15EAV	Convex	Body surface	
10.	75L50EAV	Linear	Transrectal	
11.	50L60EAV	Linear	Transrectal	
12.	35C50EA	Convex	Body surface	
13.	65EC10EA	Convex (intracavitary)	Transrectal, transvaginal	
14.	75L38EA	Linear	Body surface	
15.	65EL60EA	Linear (transrectal)	Transrectal	

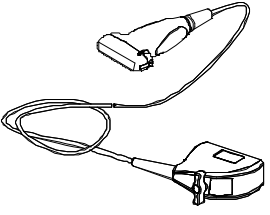
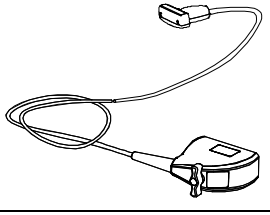
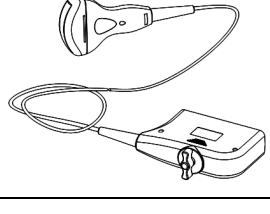
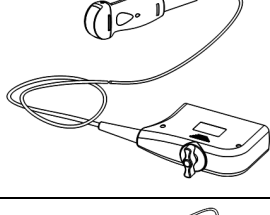
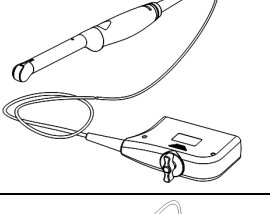
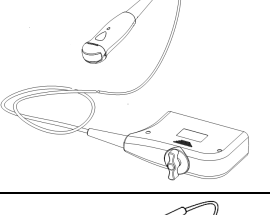
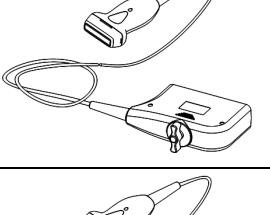
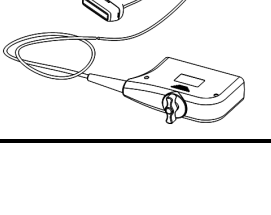
No.	Model	Type	Applied region	Illustration
16.	75L53EA	Linear	Body surface	
17.	75LT38EA	Linear	Intraoperative	
18.	35C50HA	Convex	Body surface	
19.	35C20HA	Convex	Body surface	
20.	65EC10HA	Convex (intracavitary)	Transrectal, transvaginal	
21.	65C15HA	Convex	Body surface	
22.	75L38HA	Linear	Body surface	
23.	75L38HB	Linear	Body surface	

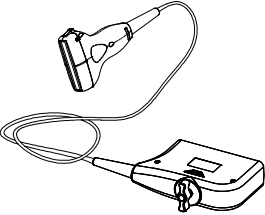
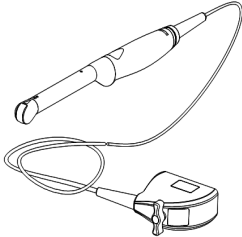
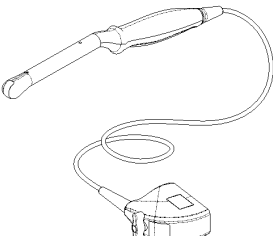
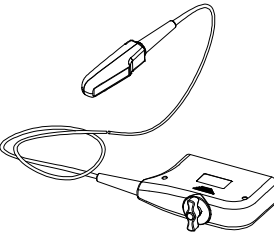
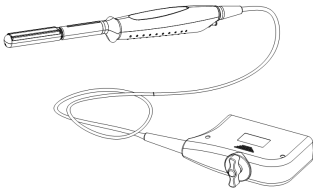
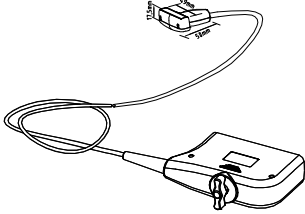
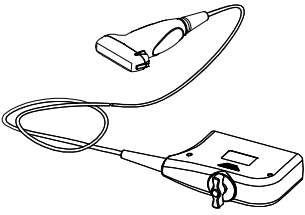
No.	Model	Type	Applied region	Illustration
24.	75L60HB	Linear	Body surface	
25.	65EC10EC	Convex (intracavitary)	Transvaginal	
26.	65EC10ED	Convex (intracavitary)	Transvaginal	
27.	65L50HAV	Linear	Transrectal	
28.	65EL66HA	Linear (transrectal)	Transrectal	
29.	75LT40HA	Linear	Intraoperative	
30.	75L53HA	Linear	Body surface	

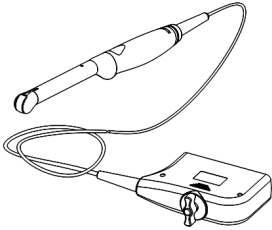
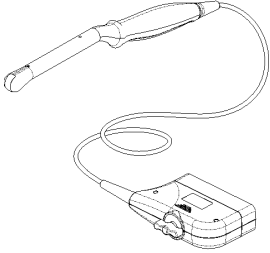
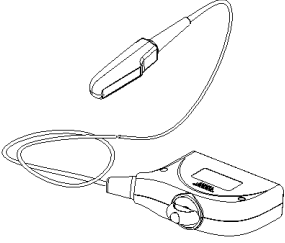
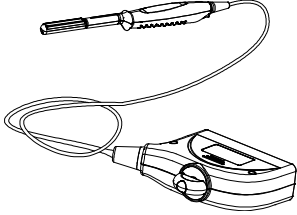
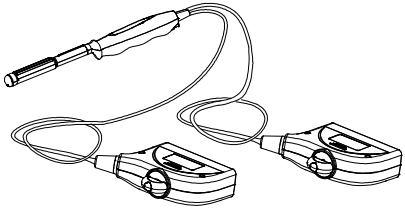
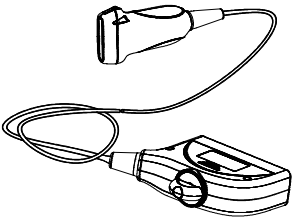
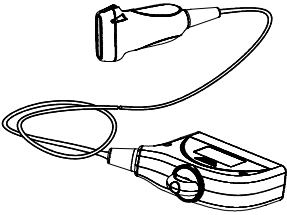
No.	Model	Type	Applied region	Illustration
31.	65EC10HC	Convex (intracavitary)	Transvaginal	
32.	65EC10HD	Convex (intracavitary)	Transvaginal	
33.	6LE5V/6LE5 Vs	Linear	Transrectal	
34.	6LE7/ 6LE7s/ 6LE7P	Linear (transrectal)	Transrectal	
35.	6LB7/6LB7s	Biplanar	Transrectal	
36.	10L4/10L4s	Linear	Body surface	
37.	7L4/7L4s	Linear	Body surface	

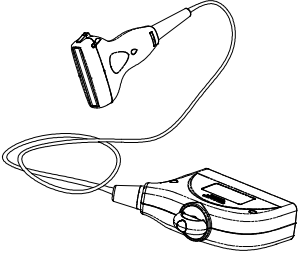
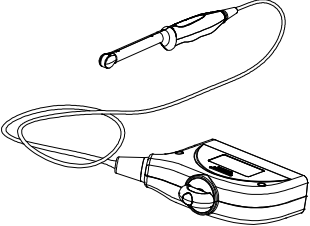
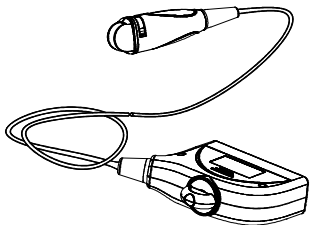
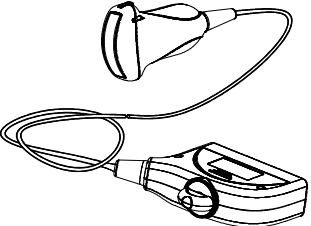
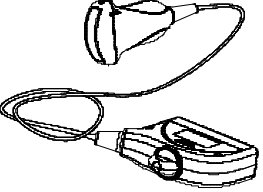
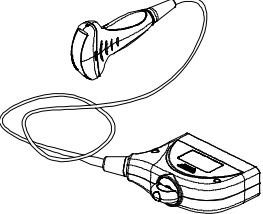
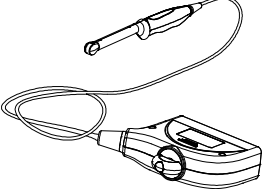
No.	Model	Type	Applied region	Illustration
38.	7L6/7L6s	Linear	Body surface	
39.	6CV1/6CV1s/6CV1P	Convex (intracavitary)	Transrectal, transvaginal	
40.	3C1/3C1s	Convex	Body surface	
41.	3C5/3C5s	Convex	Body surface	
42.	3C5A/3C5P	Convex	Body surface	
43.	C5-2/C5-2s	Convex	Body surface	
44.	V10-4/10-4s	Convex	Transvaginal	

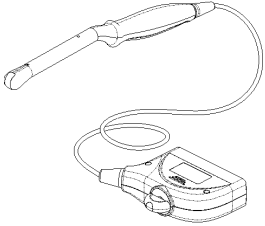
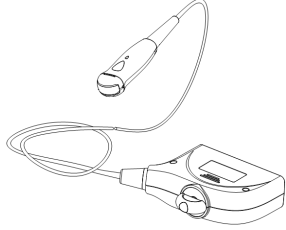
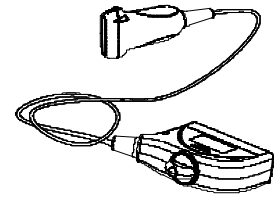
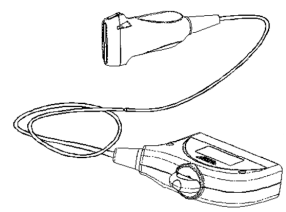
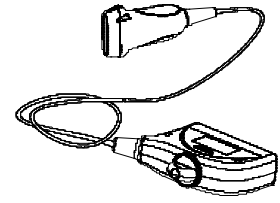
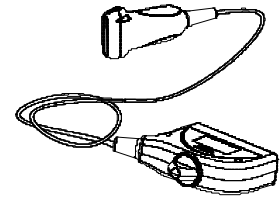
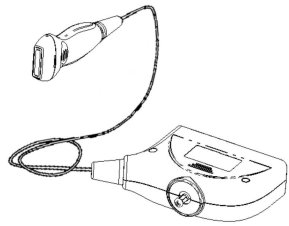
No.	Model	Type	Applied region	Illustration
45.	V10-4B/ V10-4Bs/ V10-4BP	Convex	Transvaginal	
46.	6C2/ 6C2s/ 6C2P	Convex	Body surface	
47.	7L4A/7L4P	Linear	Body surface	
48.	L11-4/L11-4s	Linear	Body surface	
49.	L12-4/L12-4s	Linear	Body surface	
50.	L7-3/L7-3s	Linear	Body surface	
51.	L14-6/L14-6s/L14-6P	Linear	Body surface	

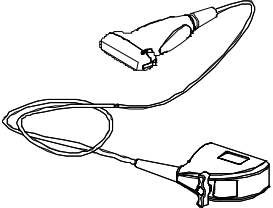
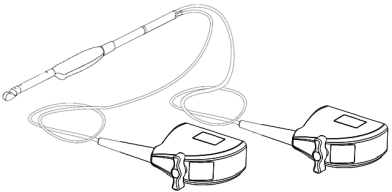
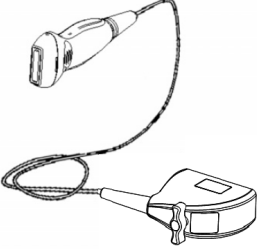
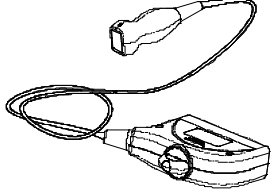
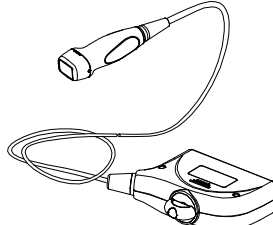
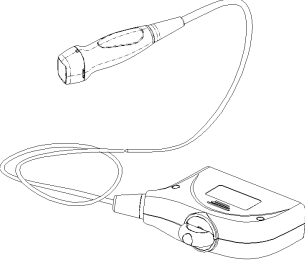

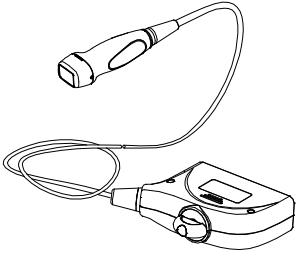
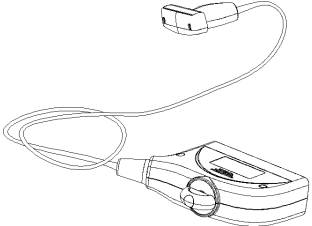
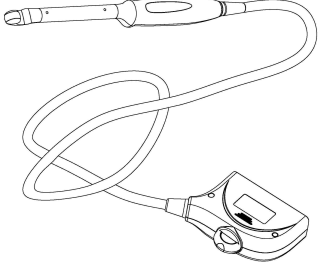
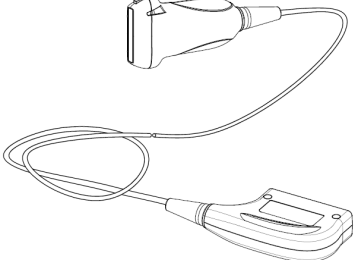
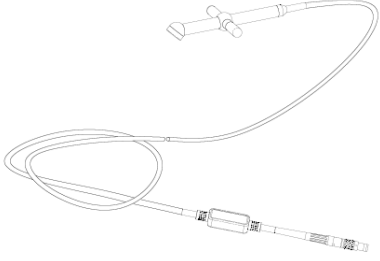
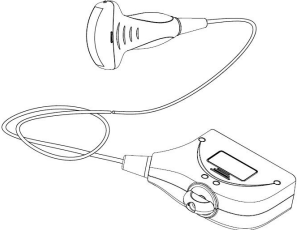
No.	Model	Type	Applied region	Illustration
52.	7L5/7L5s /7L5P	Linear	Body surface	
53.	65EB10EA	Bi-plane (convex)	Transrectal	
54.	10L24EA	Linear	Body surface	
55.	2P2/ 2P2s/ 2P2P	Phased	Body surface	
56.	P7-3/P7- 3s/P7-3E	Phased	Body surface	
57.	P12-4/ P12-4s	Phased	Body surface	

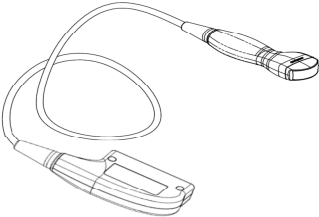
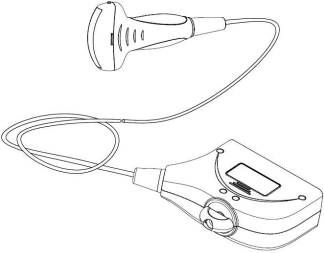
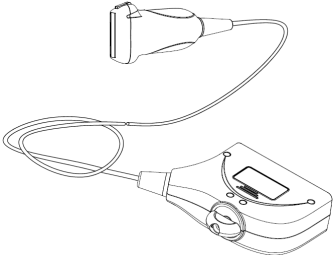
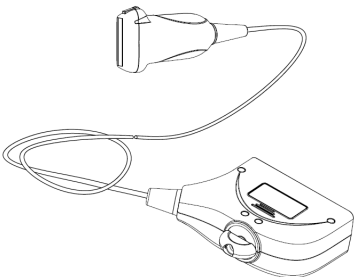
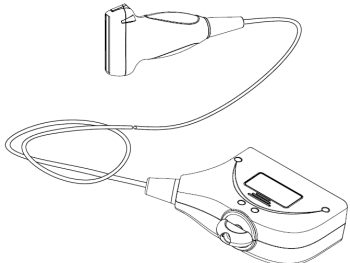
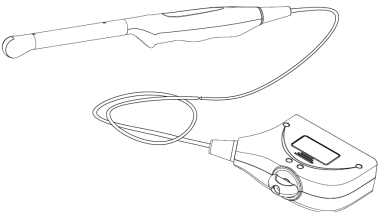
No.	Model	Type	Applied region	Illustration
58.	P4-2/P4-2s	Phased	Body surface	
59.	7LT4/ 7LT4s/ 7LT4P	Linear	Intra- operation, Body surface	
60.	CB10- 4/CB10-4P/ CB10-4E	Bi-plane (convex & convex)	Transrectal	
61.	L14-6Ns	Linear	Body surface	
62.	CW2s	Pencil probe	Body surface	
63.	C5-2E	Convex	Body surface	

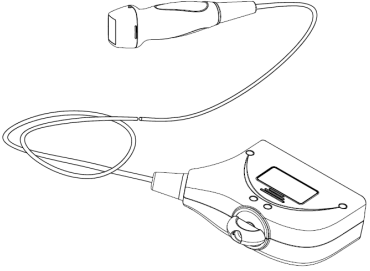
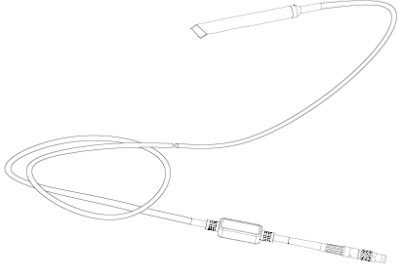
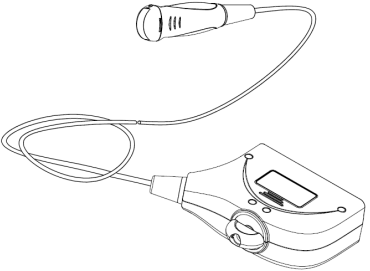
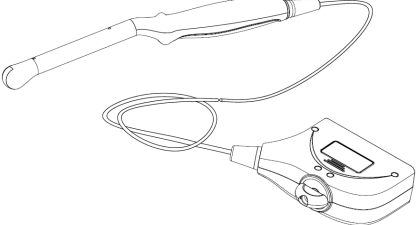
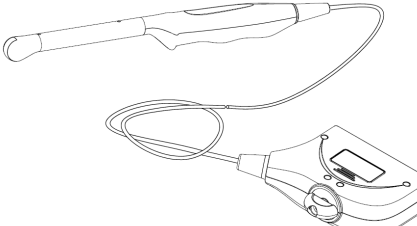
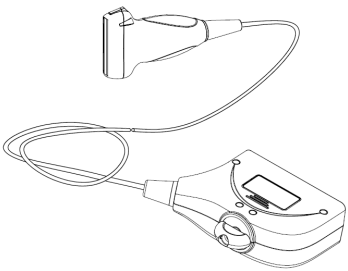

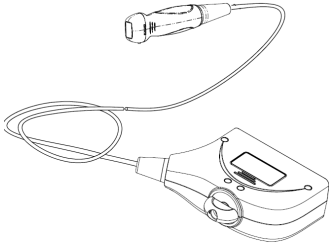
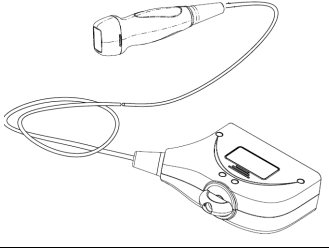
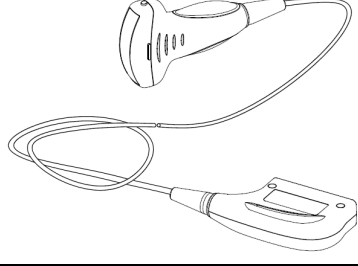
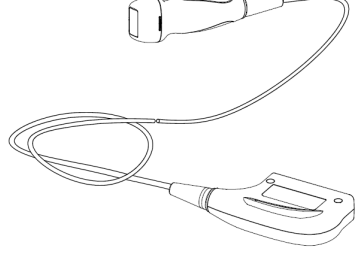
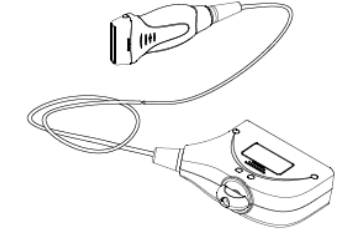
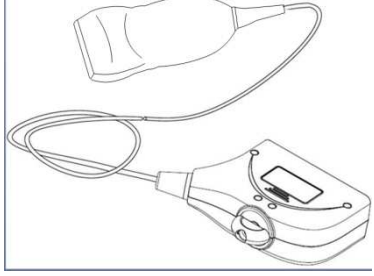

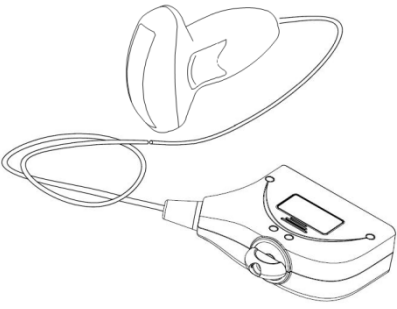
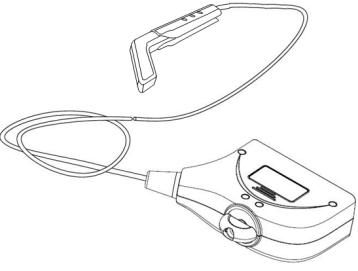
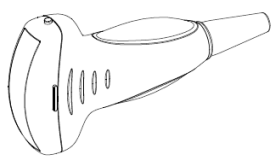
No.	Model	Type	Applied region	Illustration
64.	C6-2Gs	Convex	Body surface	
65.	C7-3E	Convex	Body surface	
66.	L12-3E	Linear	Body surface	
67.	L14-6NE	Linear	Body surface	
68.	L14-6WE/L14-6Ws	Linear	Body surface	
69.	V11-3E/V11-3	Convex	Transvaginal	

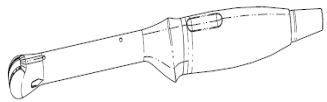
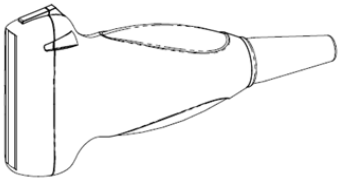
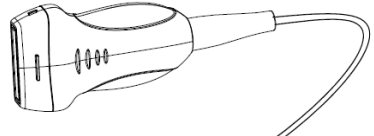
No.	Model	Type	Applied region	Illustration
70.	P4-2E	Phased	Body surface	
71.	CW5/CW5s	Pencil probe	Body surface	
72.	C11-3E/ C11-3s	Convex	Body surface	
73.	V11- 3BE/V11-3B	Convex	Transvaginal	
74.	V11-3WE/ V11-3Ws	Convex	Transvaginal	
75.	L7-3E	Linear	Body surface	

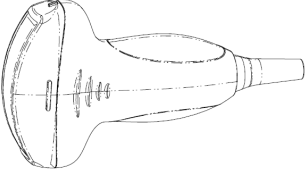
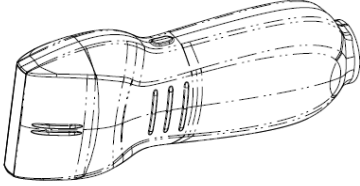
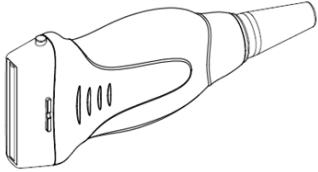
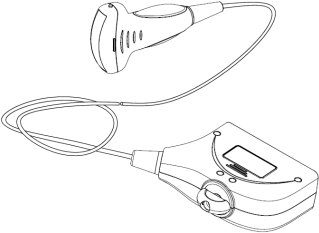
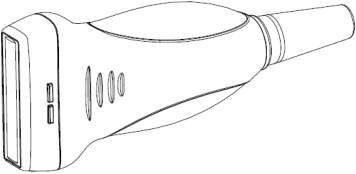
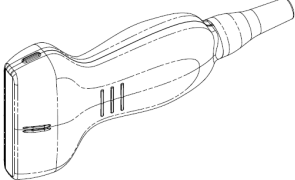
No.	Model	Type	Applied region	Illustration
76.	P10-4E/P10-4s	Phased	Body surface	
77.	P4-2NE	Phased	Body surface	
78.	C5-1s	Convex	Body surface	
79.	SP5-1s/SP5-1E	Phased	Body surface	
80.	LM14-6E/LM14-6s	Linear	Body surface	
81.	L10-3E/L10-3s	Linear	Body surface	

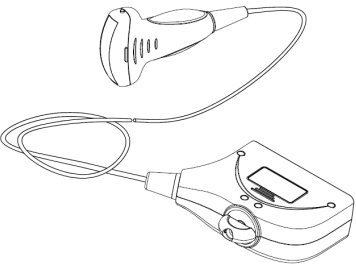
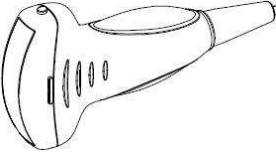
No.	Model	Type	Applied region	Illustration
82.	SC5-1E	Convex	Body surface	
83.	L16-4HE/L16-4Hs	Linear	Body surface	
84.	C5-1U	Convex	Body surface	
85.	SC8-2U	Convex	Body surface	
86.	V11-3HU	Convex	Transvaginal	
87.	L14-6WU	Linear	Body surface	
88.	L11-3U	Linear	Body surface	

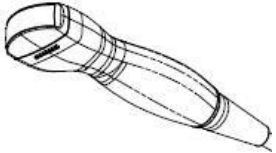
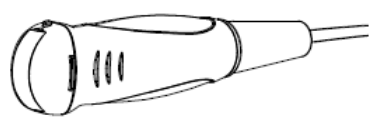
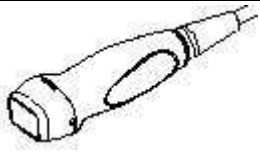
No.	Model	Type	Applied region	Illustration
89.	SP5-1U	Phased	Body surface	
90.	SC5-1U	Convex	Body surface	
91.	L20-5U/L20-5E	Linear	Body surface	
92.	LM16-4U	Linear	Body surface	
93.	C5-1E	Convex	Body surface	
94.	L9-3U	Linear	Body surface	
95.	L14-5WU/L14-5sp	Linear	Body surface	

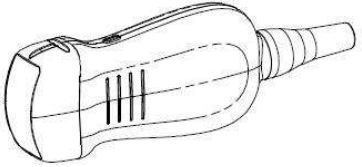
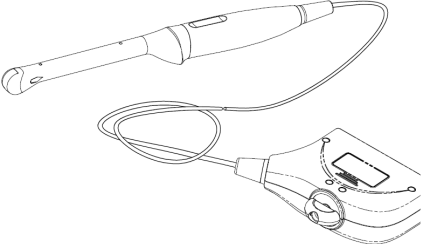
No.	Model	Type	Applied region	Illustration
96.	C5-2	Convex	Body surface	
97.	SC6-1U	Convex	Body surface	
98.	P10-4U	Phase	Body surface	
99.	C6-2GU	Convex	Body surface	
100.	C11-3U	Convex	Body surface	
101.	P7-3U	Phase	Body surface	
102.	L16-4HU	Linear	Body surface	
103.	C4-1U	Convex	Body surface	
104.	V11-3HE	Convex	Transvaginal	

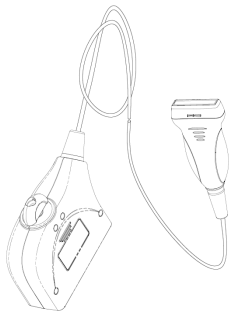
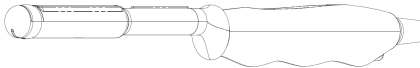
No.	Model	Type	Applied region	Illustration
105.	L9-3E	Linear	Body surface	
106.	6LB7E	Biplanar	Transrectal	

Tips: the transducer whose model is ended with an "s" (7L5s, for example) is to be used with the Doppler ultrasound system, except the connector of this transducer, other parts are the same as the corresponding transducer whose model is not ended with an "s" (7L5, for example). See the figure below for the connector of the transducer whose model is ended with an "s".

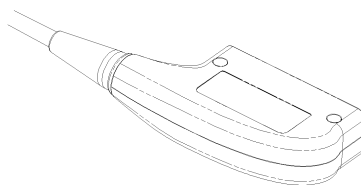

1.4.2 Needle-guided Bracket Model

Model	Matched Transducer(s)	Type	Biopsy Angle/Depth ($\pm 1^\circ$)	Applicable Needle	Biopsy
NGB-001	35C50HA 35C50EA	Metal/needle un-detachable	25°, 35°, 45°	13G, 15G, 16G, 18G, 20G	
	35C50EB 35C50P	Metal/needle detachable	25°, 35°, 45°	14G, 16G, 18G, 20G, 22G	
NGB-002	75L38HA 75L38HB 75L38EA 75L38EB 75L38P	Metal/needle un-detachable	40°, 50°, 60°	13G, 15G, 16G, 18G, 20G	
NGB-003	35C20HA 35C20EA	Metal/needle un-detachable	11°, 23°	13G, 15G, 16G, 18G, 20G	
		Metal/needle detachable	11°, 23°	14G, 16G, 18G, 20G, 22G	
NGB-004	65EC10EA 65EC10EB 65EC10EC 65EC10ED 65EC10HA 65EC10HC 65EC10HD 65EB10EA 6CV1(s) 6CV1P V10-4(s) V10-4B(s) V10-4BP CB10-4 CB10-4P CB10-4E V11-3E V11-3BE V11-3WE V11-3Ws V11-3 V11-3B	Metal/needle un-detachable	/	16G, 17G, 18G	

Model	Matched Transducer(s)	Type	Biopsy Angle/Depth ($\pm 1^\circ$)	Applicable Needle	Biopsy
NGB-005	65C15HA 65C15EA 65C15EAV 6C2(s) 6C2P	Metal/needle undetachable	12.7°, 24.2°	13G, 15G, 16G, 18G, 20G	
NGB-006	3C5(s) 3C5A 3C5P	Plastic/needle detachable, metal	25°, 35°, 45°	13G, 15G, 16G, 18G, 20G	
		Metal/needle detachable	25°, 35°, 45°	14G, 16G, 18G, 20G, 22G	
NGB-007	7L4(s) 7L4A 7L4P 10L4(s) 75L53EA 75L53HA 7L5(s) 7L5P L7-3(s) L7-3E L11-4(s) L12-4(s) L14-6Ns L14-6NE L12-3E L14-6WE L14-6Ws L14-6WU	Plastic/needle detachable, metal	40°, 50°, 60°	13G, 15G, 16G, 18G, 20G	
		Metal/needle detachable	40°, 50°, 60°	14G, 16G, 18G, 20G, 22G	
NGB-008	3C1(s)	Plastic/needle detachable, metal	11°, 23°	13G, 15G, 16G, 18G, 20G	
		Metal/needle detachable	11°, 23°	14G, 16G, 18G, 20G, 22G	
NGB-009	6LB7(s) 6LE7(s) 6LE7P 65EL60EA 65EL66HA	Metal/needle detachable	/	13G, 15G, 16G, 18G, 20G	

Model	Matched Transducer(s)	Type	Biopsy Angle/Depth ($\pm 1^\circ$)	Applicable Needle	Biopsy
NGB-010	7LT4(s) 7LT4P 75LT38EA 75LT40HA	Metal/needle detachable	30°, 40°, 50°	13G, 15G, 16G, 18G, 20G	
NGB-011	2P2(s) 2P2P P4-2(s) P4-2E P4-2NE SP5-1s SP5-1E SP5-1U	Metal/needle undetachable	11°, 23°	13G, 15G, 16G, 18G, 20G	
NGB-012	75L60HB 75L60EA 7L6(s)	Plastic/needle detachable, metal	40°, 50°, 60°	13G, 15G, 16G, 18G, 20G	
		Metal/needle detachable	40°, 50°, 60°	14G, 16G, 18G, 20G, 22G	
NGB-015	C5-2(s) C5-2E	Metal/needle detachable	25°, 35°, 45°	14G, 16G, 18G, 20G, 22G	
NGB-016	L14-6(s) L14-6P 10L24EA	Metal/needle detachable	30°, 40°, 50°	14G, 16G, 18G, 20G, 22G	
NGB-018	C11-3E/ C11-3s/C11-3U	Metal/needle detachable	15°, 25°, 35°	14G, 16G, 18G, 20G, 22G	
NGB-019	C7-3E	Metal/needle detachable	20°, 30°, 40°	14G, 16G, 18G, 20G, 22G	
NGB-022	C5-1U/C6-2/SC6-1U	Metal/needle detachable	25°, 35°, 45°	14G, 16G, 18G, 20G, 22G	
NGB-023	LM14-6E LM14-6s LM16-4U	metal/needle detachable	40°, 50°, 60°	14G, 16G, 18G, 20G, 22G	
NGB-024	C6-2Gs/C6-2GU	metal/needle detachable	7°, 25°, 30°	14G, 16G, 18G, 20G, 22G	
NGB-025	V11-3HU/V11-3HE	metal/needle undetachable	1.6°	16G, 17G, 18G	
NGB-026	L11-3U	metal/needle detachable	40°, 50°, 60°	14G, 16G, 18G, 20G, 22G	

Model	Matched Transducer(s)	Type	Biopsy Angle/Depth ($\pm 1^\circ$)	Applicable Biopsy Needle
NGB-031	SC5-1U	metal/needle detachable	25°, 35°, 45°	14G, 16G, 18G, 20G, 22G
NGB-034	L9-3U/L9-3E	metal/needle detachable	40°, 50°, 60°	Metal: 4G, 16G, 18G, 20G, 22G
NGB-036	C4-1U	metal/needle detachable	7°, 25°, 35°	Metal: 14G, 16G, 18G, 20G, 22G

1.5 Composition

The following items are supplied with each transducer.

Items	Quantity
Ultrasonic transducer	1
Operator's manual	1
Syringe	1(for 6LE7(s/P), 6LB7(s), 6LB7E, 65EL60EA, 65EL66HA only)

1.5.1 Transducer Functions by Part

This section describes the name and function of each part as well as the immersible range of the ultrasonic transducer.

The transducer is classified as "IPX7" according to the degree of protection against harmful ingress of water (from the transducer head to the cable protector).

The connector is not waterproof and must not be immersed into liquids such as disinfectant.

The transducer is shown as follows (take 3C5A as an example):

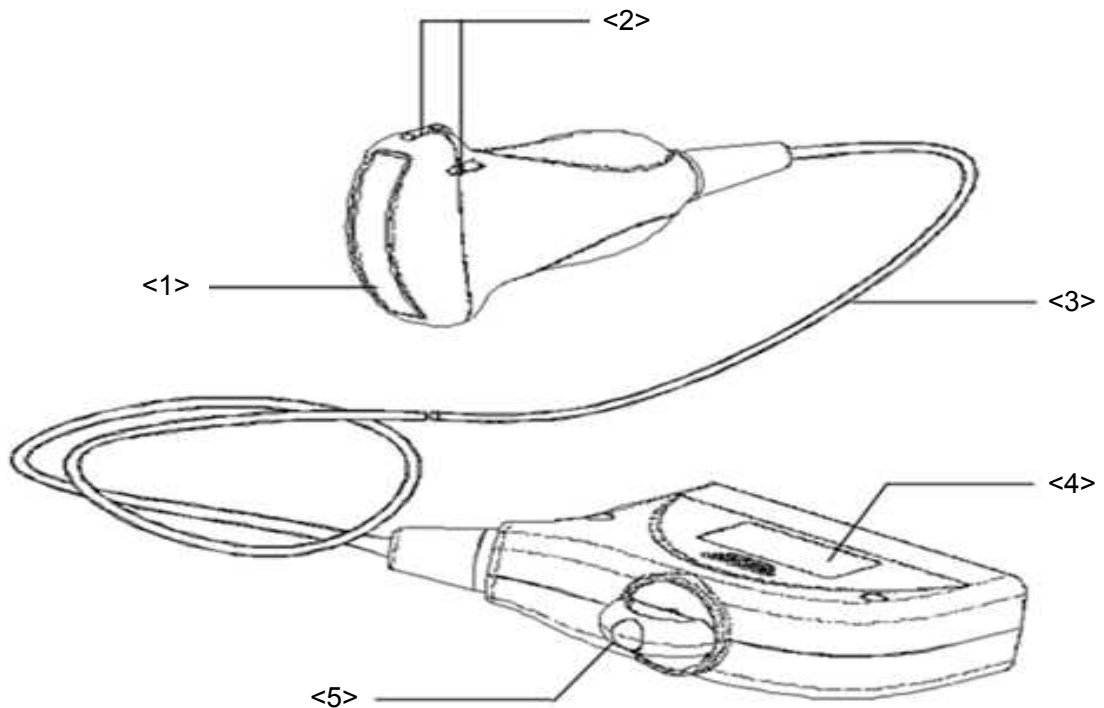

No.	Name	Function
<1>	Transducer head	Converts the electrical signal into an ultrasonic signal, focusing the sound beams in a given direction; meanwhile, it receives the reflected ultrasonic signal and converts it into an electrical signal for transmission over the cable. The lens on the surface is the acoustic lens. Apply ultrasound gel on the acoustic lens for correct operation.
<2>	Needle-guided bracket fix tabs and grooves	Provides mounting support of the needle-guided bracket.
<3>	Transducer cable	Transmits electrical signals between the transducer body and connector.
<4>	Transducer connector	Connects the transducer and cable to the ultrasonic diagnostic system.
<5>	Lock handle	Locks the connector to the ultrasonic diagnostic system.

Tips:

The transducers' structure marked <2> in the figure above may vary with the matched needle-guided brackets.

Biplanar transducer 6LB7:

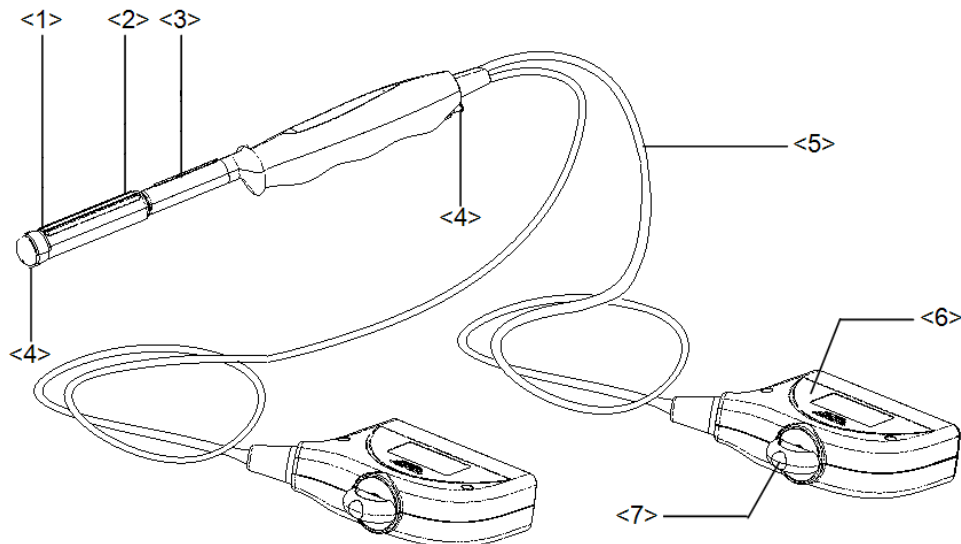

No.	Name	Function
<1>	<1>Transducer head (convex)	Converts the electrical signal into an ultrasonic signal, focusing the sound beams in a given direction; meanwhile, it receives the reflected ultrasonic signal and converts it into an electrical signal for transmission over the cable. The lens on the surface is the acoustic lens. Apply ultrasound gel on the acoustic lens for correct operation.
<2>	<2>Transducer head (linear)	
<3>	Needle-guided bracket fix tab	Supports mounting of the needle-guided bracket.
<4>	Water injection/drainage port	Provides an interface for injecting and draining water.
<5>	Cable	Transmits electrical signals between the transducer body and connector.
<6>	Connector	Connects the transducer and cable to the ultrasonic diagnostic system.
<7>	Lock handle	Locks the connector to the ultrasonic diagnostic system.

6LE7:

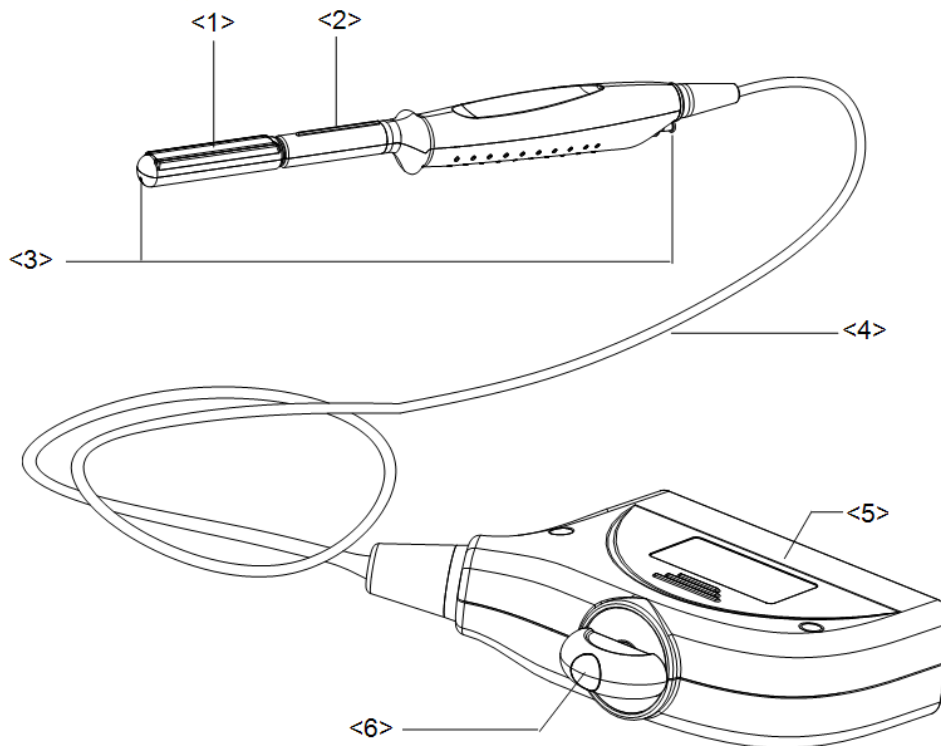

No.	Name	Function
<1>	Transducer head	Converts the electrical signal into an ultrasonic signal, focusing the sound beams in a given direction; meanwhile, it receives the reflected ultrasonic signal and converts it into an electrical signal for transmission over the cable. The lens on the surface is the acoustic lens. Apply ultrasound gel on the acoustic lens for correct operation.
<2>	Needle-guided bracket fix tab	Mount the needle-guided bracket using this tab.
<3>	Water injection/drainage port	Used for inject/drain water
<4>	Cable	This transmits electrical signals between the transducer body and connector.
<5>	Connector	This connects the transducer to the ultrasonic diagnostic system.
<6>	Lock handle	This locks the connector to the ultrasonic diagnostic system.

Intraoperative transducers 7LT4/7LT4s/75LT38EA/75LT40HA (Take 7LT4 as an example):

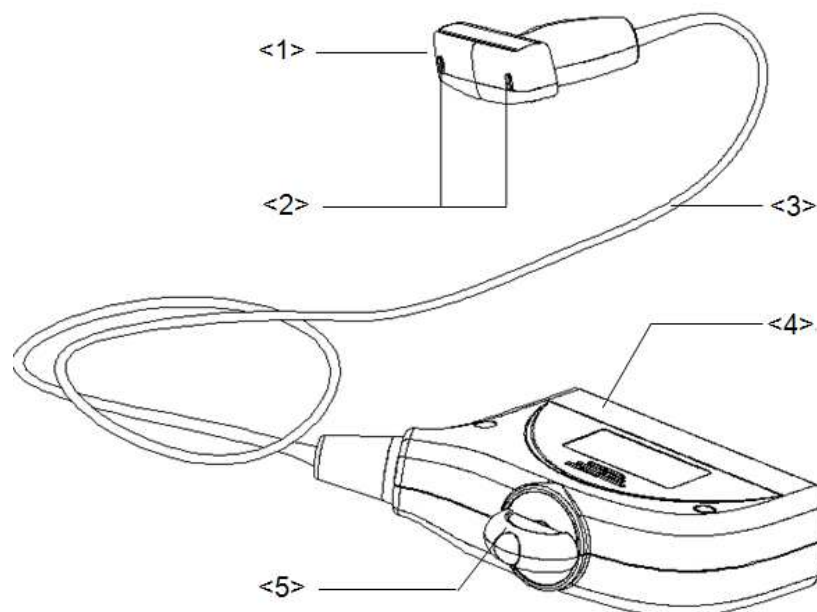

No.	Name	Function
<1>	Transducer head	Converts the electrical signal into an ultrasonic signal, focusing the sound beams in a given direction; meanwhile, it receives the reflected ultrasonic signal and converts it into an electrical signal for transmission over the cable. The lens on the surface is the acoustic lens. Apply ultrasound gel on the acoustic lens for correct operation.
<2>	Needle-guided bracket fix grooves	Mounts the needle-guided bracket using these grooves.
<3>	Cable	Transmits electrical signals between the transducer body and connector.
<4>	Connector	Connects the transducer to the ultrasonic diagnostic system.
<5>	Lock handle (not for 7LT4s)	Locks the connector to the ultrasonic diagnostic system.

1.6 Procedures for Operating the Transducer

This section describes general procedures for operating the transducer.

The proper clinical technique to be used for operating the transducer should be selected on the basis of specialized training and clinical experience.

Procedures for operating (with biopsy function):

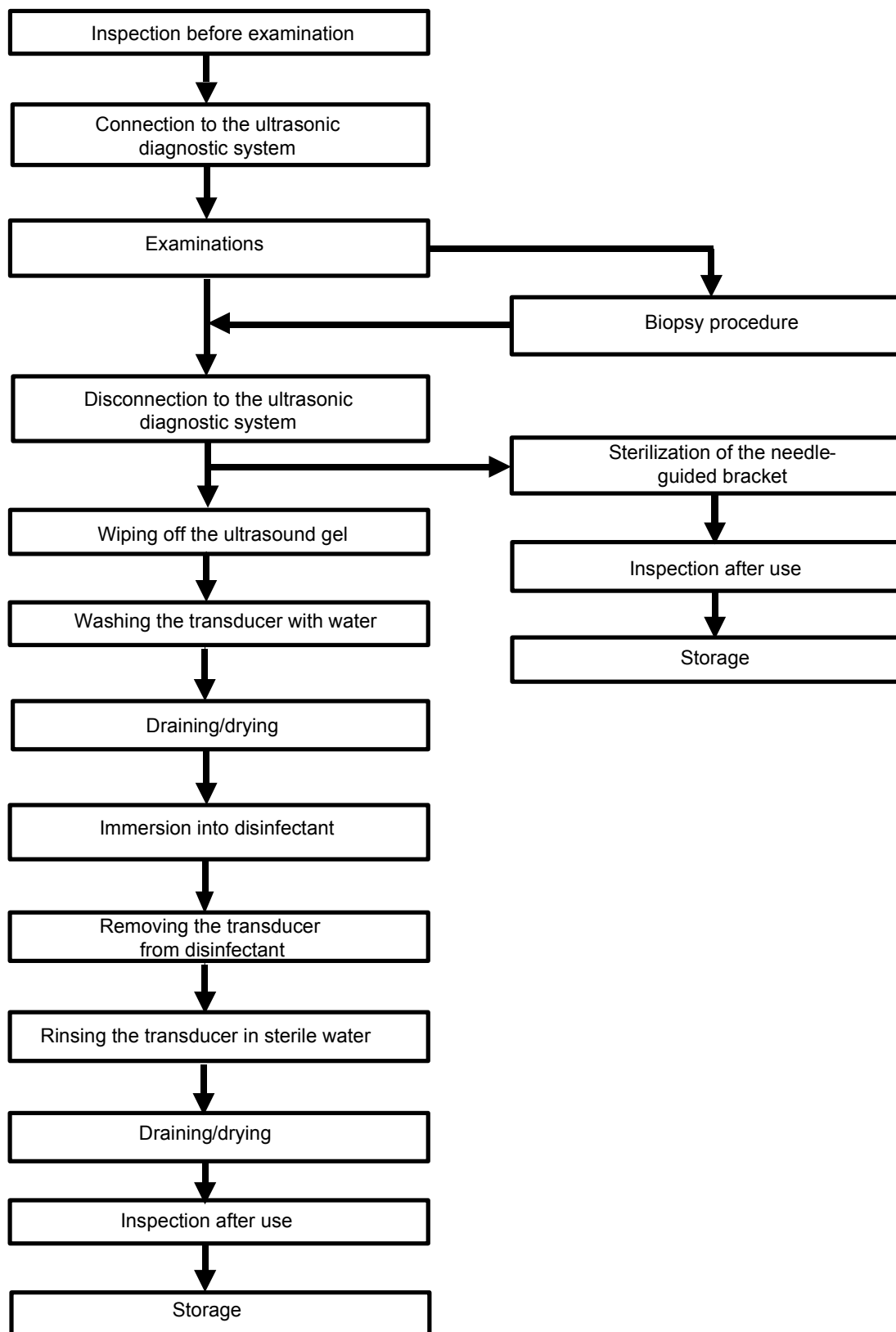

Procedures for operating (with no biopsy function):

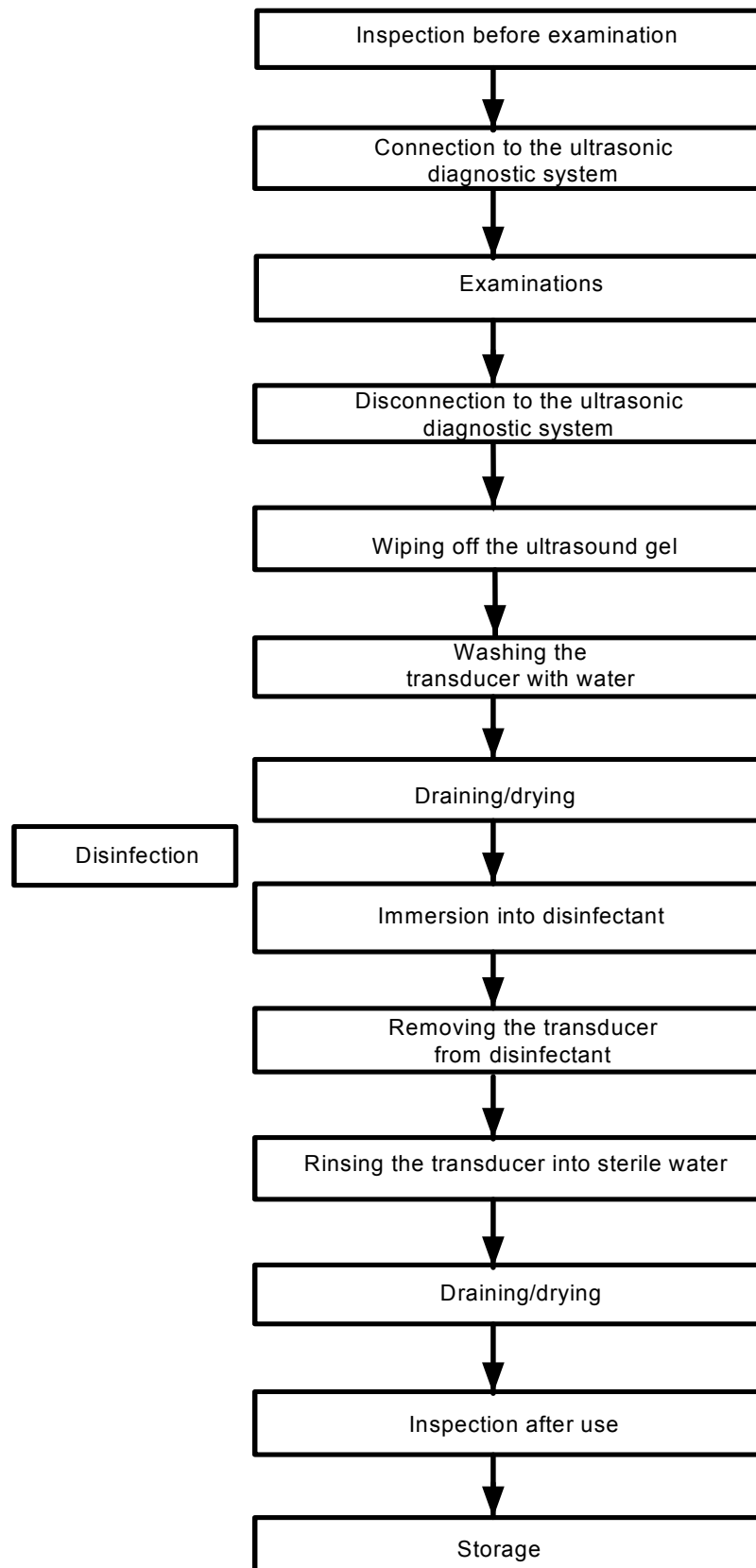

 **WARNING:**

Disinfect the transducer and sterilize the needle-guided bracket before and after an ultrasound-guided biopsy procedure is performed. Failure to do so may cause the transducer and the needle-guided bracket become source of infection.

2 Connecting the Transducer to the System

The transducer can be used with compatible ultrasonic diagnostic systems.

NOTE: Before connecting or disconnecting a transducer, freeze or turn off the ultrasonic diagnostic system, otherwise the ultrasonic diagnostic system or the transducer may malfunction.

2.1 Connecting and Disconnecting the Transducer

For non-portable Doppler Ultrasound System Compliant Transducer

Connecting the transducer:

After freezing or turning off the ultrasonic diagnostic system, align the connector with the transducer connector port of the ultrasonic diagnostic system, then turn the lock handle 90° clockwise to lock it securely. See the figure below:

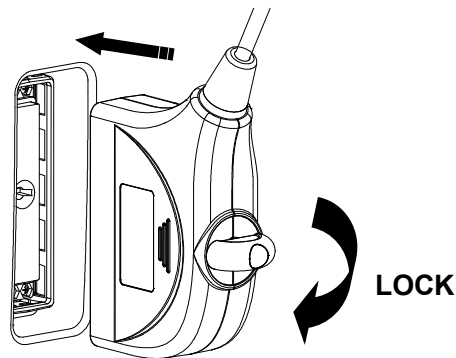

Disconnecting the Transducer:

After freezing or turning off the ultrasonic diagnostic system, turn the lock handle 90° anticlockwise to unlock the transducer. Remove the connector by pulling it out straight. See the figure below:

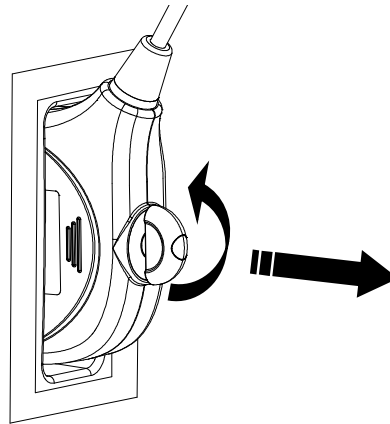

For Portable Doppler Ultrasound System Compliant Transducer

Connecting the transducer:

To connect the transducer, insert the connector fully into the socket. Toggle the transducer lock lever, which is beside the socket, to the upper position. See the figure below.

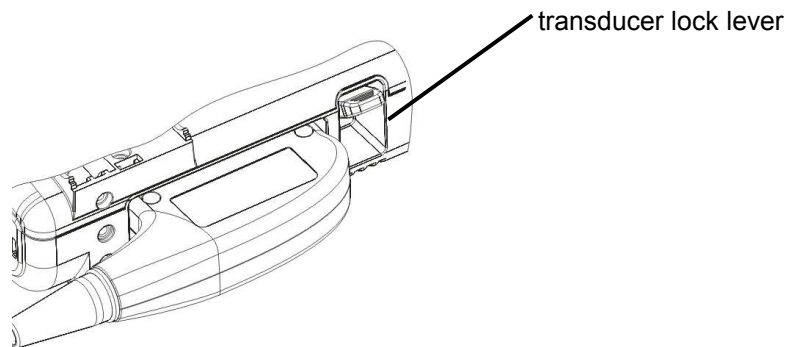

Disconnecting the Transducer:

To disconnect the transducer, toggle the transducer lock lever to the lower position, and pull out the transducer evenly from the socket. See the figure below.

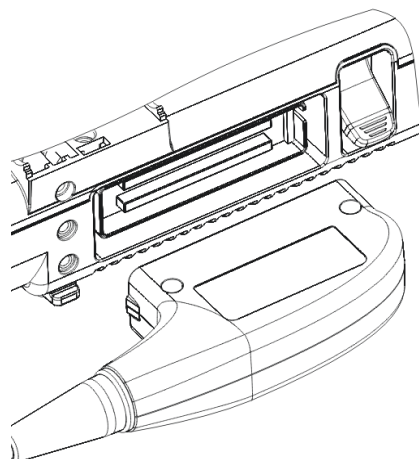

3 Inspection Before and After Use

Inspection before and after use must be performed as described below to ensure safe operation of the transducer.

If any abnormality is found, immediately stop using the transducer and contact MINDRAY Customer Service Department or sales representative.

3.1 Check the External Appearance of the Transducer

Confirm that there are no abnormalities of the transducer surface or cable sheath, such as peeling, cracks, protruding parts, or looseness of the acoustic lens, before and after each examination.

⚠ WARNING: Transducer abnormalities may cause electric shock or injury to the patient. If any abnormality is found, immediately stop using the transducer and contact your MINDRAY Customer Service Department or sales representative.

3.2 Cleaning the Transducer

Clean and disinfect the transducer before and after each examination.

⚠ CAUTION: If you don't clean and disinfect the transducer, it may become a source of infection.

3.3 Checking after Turning on the System

After turning ON the power of the ultrasonic diagnostic system, perform the following checks.

1. The acoustic lens of the transducer must not generate abnormal heat while it is being used. The transducer temperature should be checked by hand.

⚠ CAUTION: If you keep a hot acoustic lens on the body surface, the patient may be burned.

2. The image must not be abnormal while turning on the system.

⚠ CAUTION: Any of the problems mentioned above indicates that the ultrasonic diagnostic system or the transducer may be defective.

4 Operating Procedures

This section describes general procedures for operating the transducer.

The operator should have adequate clinical experience and received related training.

- | |
|---|
| <p>⚠ CAUTION:</p> <ol style="list-style-type: none">1. Clean and disinfect the transducer before and after each examination.2. When using the transducer, wear sterile gloves to prevent infection. |
|---|

4.1 Orientation of the Ultrasound Image and the Transducer Head

The orientation of the ultrasound image and the transducer are shown as below (using linear transducer as an example). The “MARK” side of the ultrasound image on the monitor corresponds to the mark side of the transducer. Check the orientation before the examination.

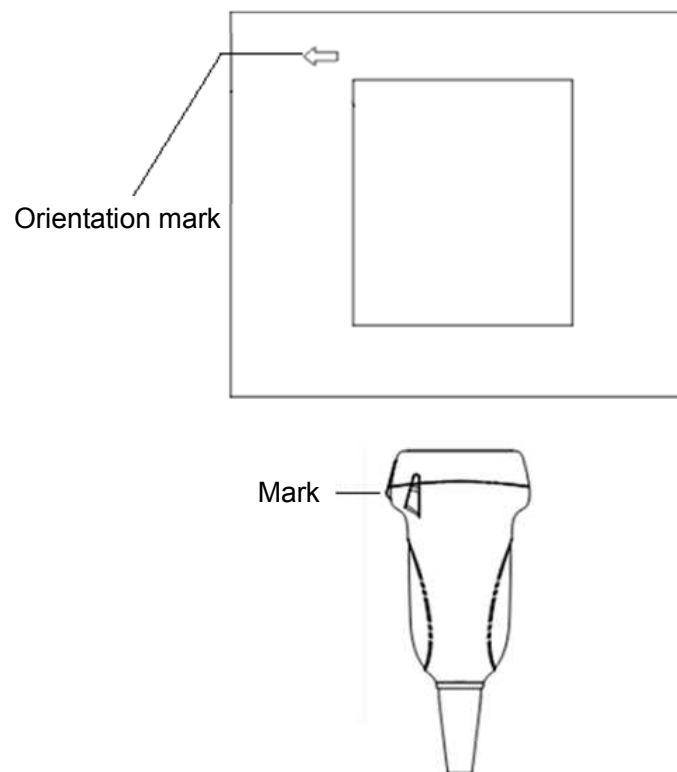

Orientation of the Ultrasound Image and the Transducer Head

4.2 Utilizing the Transducer Sheath

A legally marketed transducer sheath must be installed over the transducer before performing intra-cavitary examination. Protective barriers may be required to minimize disease transmission. Transducer sheaths are available for use with all clinical situations where infection is a concern.

To order transducer sheath, contact:

CIVCO Medical Instruments Co.

102 First Street South, Kalona, IA 52247-9589 USA Tel: 1-319-656-4447

E-mail: info@civco.com

<http://www.civco.com>

⚠ CAUTION:

1. Be sure to cover the transducer with a new (unused) transducer sheath to prevent infection during examination. If the package of a transducer sheath is open or broken, the sterilization of the transducer sheath may not be sufficient. **DO NOT** use such a transducer sheath.
2. The cover contains natural rubber latex and talc that can cause allergic reactions in some individuals.
3. **DO NOT** use an expired transducer sheath. Before using transducer sheaths, verify whether the term of validity has expired.

Method (for reference only):

1. Place an appropriate amount of gel inside the sheath or on the transducer acoustic lens. Poor imaging may result if no gel is used.
2. Insert the transducer into the sheath. Pull cover tightly over transducer acoustic lens to remove wrinkles and air bubbles, and taking care to avoid puncturing the sheath.

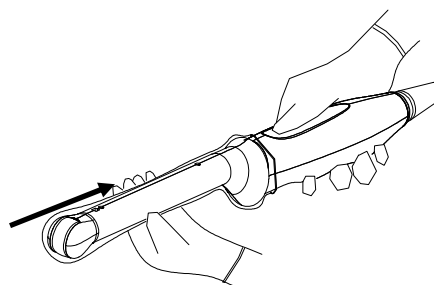
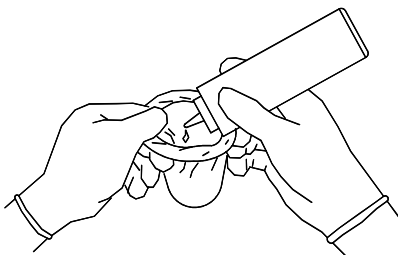

3. Secure the sheath with the enclosed elastic bands.
4. Inspect the sheath to ensure there are no holes or tears.

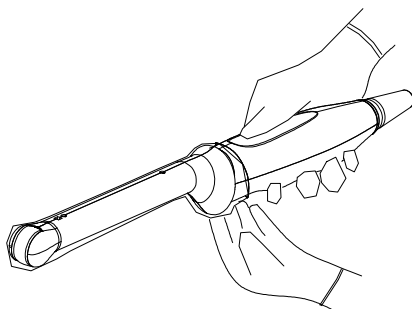

4.3 When the Immersion Method is Used

Water immersion is required when performing an ultrasound exam using transducers, including 6LE7(s), 6LE7P, 6LB7(s), 6LB7E, 65EL60EA, and 65EL66HA.

The Mindray recommends using syringe: CIVCO 610-224. Transducer 6LB7 is used as an example to describe the immersion method.

Perform the following operations before using the syringe.

1. Open the syringe pack and remove the syringe.
2. Take out the dustproof cap at the end of the syringe's extension tube, as shown in the following figure.



3. Push back the locking nut to extend the connector, as shown in the following figure. The connector should be connected to the transducer's injection/drainage port.

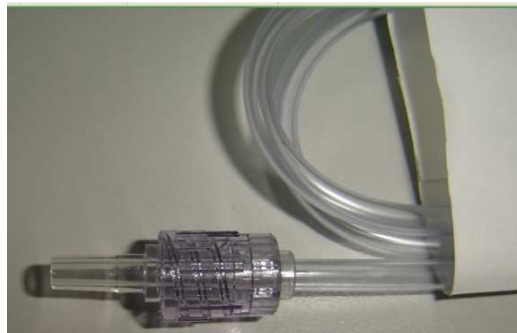

Please refer to the following operations when the immersion method is used.

1. Put on the transducer cover.

For the procedures of putting
on the transducer sheath,
refer to subsection above.

Check the transducer sheath
for wrinkles and gaps.

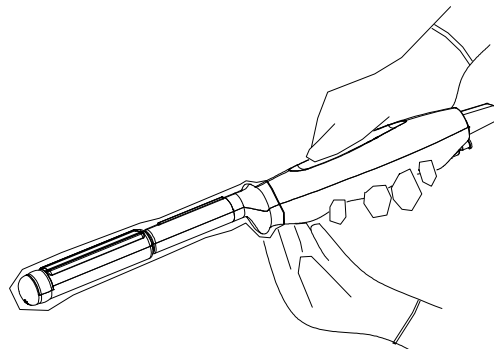

2. Fill syringe with sterile water and connect extension tube to syringe, discharge all air in the tube. Attach the syringe to transducer fill port.

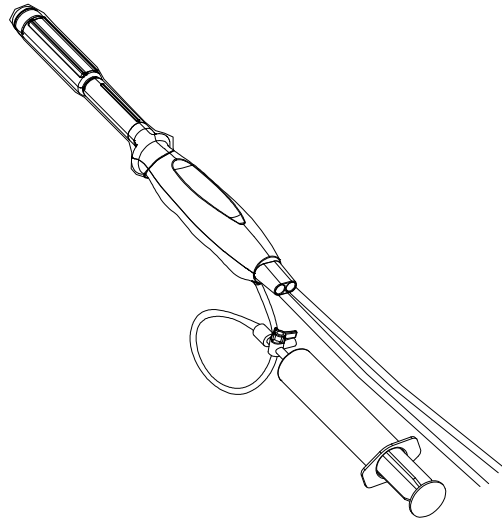

3. Orient transducer downward and inject sterile water up to the level a few cm above the end of the transducer surface.

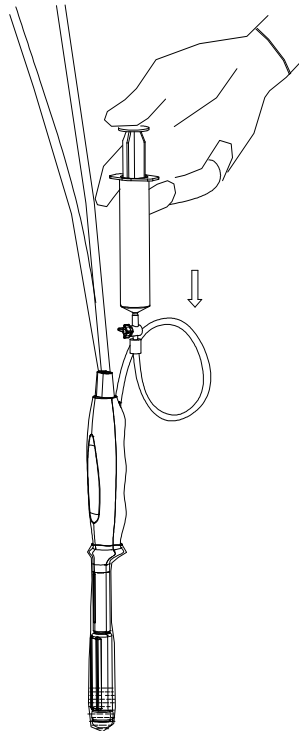

- 4. Orient transducer upward to discharge air in transducer cover.

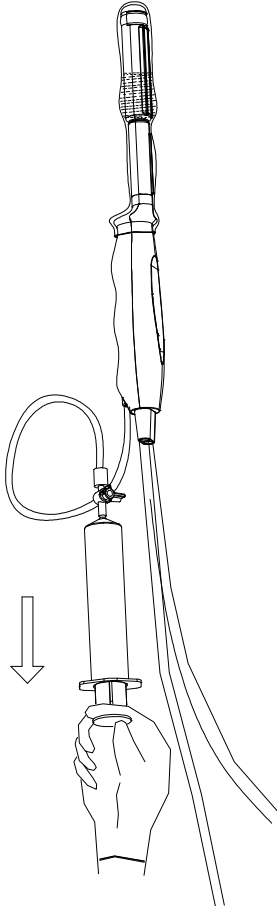

- 5. Turn the valve of the syringe to the position shown in the right figure, and then push the plunger of the syringe to discharge the air.

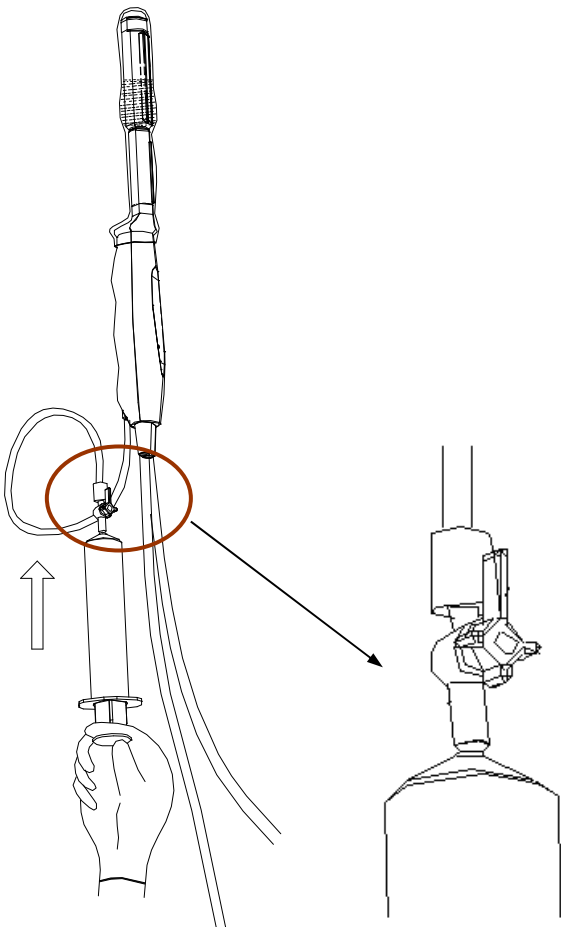

- 6. Return the valve of the syringe to the original position; orient the transducer downward to discharge sterile water.

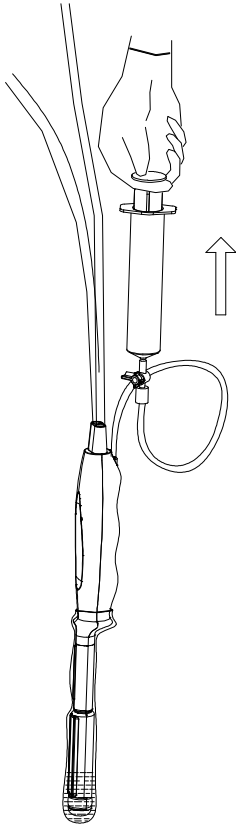

4.4 Examinations

The operator should adopt proper ultrasonic scanning procedures and methods according to different target organs.

NOTE: It is required to practice ALARA when operating ultrasonic diagnostic system.

4.5 After Examinations

After the examination is completed, turn OFF the ultrasonic diagnostic system and refer to Chapter 5 “Cleaning and Disinfection” to clean and disinfect the transducer.

After completing each examination, disinfect the transducer as necessary.

After disinfecting the transducer, confirm that the transducer is in good condition and store it in a suitable place so that the next examination can be conducted smoothly.

5 Cleaning and Disinfection

After completing each examination, clean and disinfect (or sterilize) the probes as required. When biopsy procedures have been performed, be sure to sterilize the needle-guided bracket. Fail to do so may result in the probe and the needle-guided bracket to becoming sources of infection. Please follow the instructions in the manual for cleaning.



WARNING:

Never immerse the probe connector into liquid such as water or disinfectant. Immersion may cause electrical shock or malfunction.



CAUTION:

1. **When performing cleaning and disinfection of the probe to prevent infection, wear sterile gloves.**



2. **After disinfection, rinse the probe thoroughly with sterile water to remove all chemical residues. Chemical residues on the probe may be harmful to the human body.**

3. **No cleaning and disinfecting may result in the probe becoming a source of infection.**

NOTE:

1. After the examination, wipe off the ultrasound gel thoroughly. Otherwise, the ultrasound gel may solidify and degrade the image quality of the transducer.
2. **DO NOT** make the probe to become overheated (more than 55°C) during cleaning and disinfections. High temperature may cause the probe to become deformed or damaged.

5.1 Cleaning

Please refer to the instructions in the manual and follow your hospital policy and procedures for cleaning.

1. Disconnect the probe from the system.
2. Wear sterile gloves to prevent infection.
3. Wash the transducer with clean water or soapy water to remove all the foreign matters, or, wipe the transducer with a soft ethyl carbamate sponge. Avoid using a brush, because it may damage the transducer.
4. Dry the transducer using a sterile cloth or gauze after rinsing. Do not dry the transducer by heating it.

5.2 High Level Disinfections

Disinfecting with Sprays or Wipes

⚠ CAUTION: Use protective eyewear when disinfecting using sprays.

1. Wear sterile gloves to prevent infection.
2. After you have finished cleaning, spray or wipe the transducer with a disinfectant. Follow the disinfectant manufacturer's recommended contact time and mode.
3. Remove any residue with a water-moistened soft cloth on the transducer.
4. Wipe off water on the transducer using sterile cloth or gauze after washing.

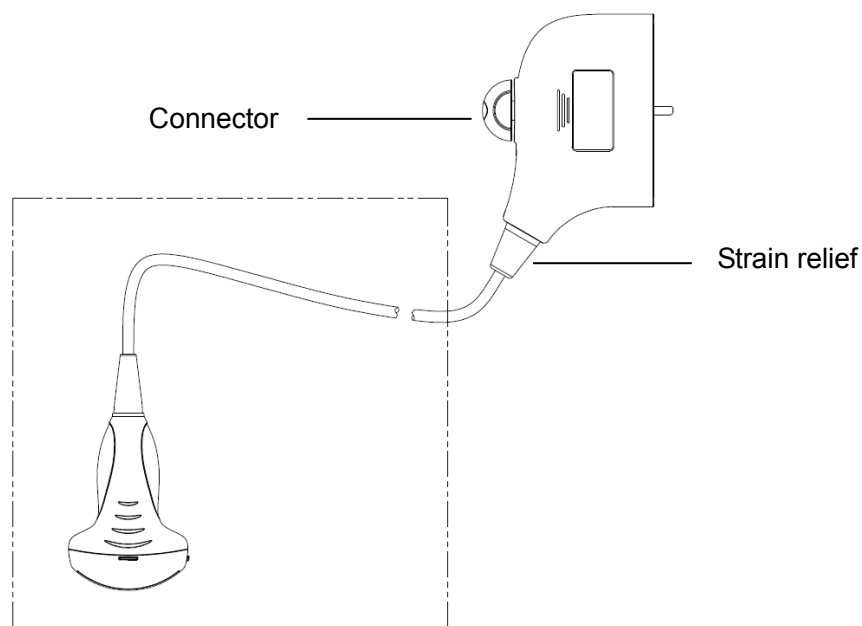

NOTE: Observe the graph here carefully to perform disinfection. Do not spray the strain relief on the connector end or the connector.

Disinfecting by Immersion

1. Wear sterile gloves to prevent infection.
2. Clean the transducer before disinfecting it. MINDRAY recommends the following solutions to disinfect the transducer.
 - Refer to the instructions provided by the chemical manufacturer concerning concentration of the disinfectant solution, method of disinfection and dilution and cautions during use. Do not soak the transducer connector or the cable near it into water or any solution.
 - Soak the transducer into the disinfectant solution for the shortest time the manufacturer recommends (for example, the shortest time recommended by the manufacturer for soaking Cidex OPA is 12 minutes).
 - Follow local regulations when selecting and using the disinfectant.

3. Rinse the transducer with plenty of sterile water (about 2 gallons) for at least 1 minute to remove all chemical residues on it. Or, follow the rinsing method recommended by the disinfectant manufacturer to rinse the transducer.
4. Wipe off the water on the transducer with sterile cloth or gauze after rinsing it. Do not dry the transducer by heating.

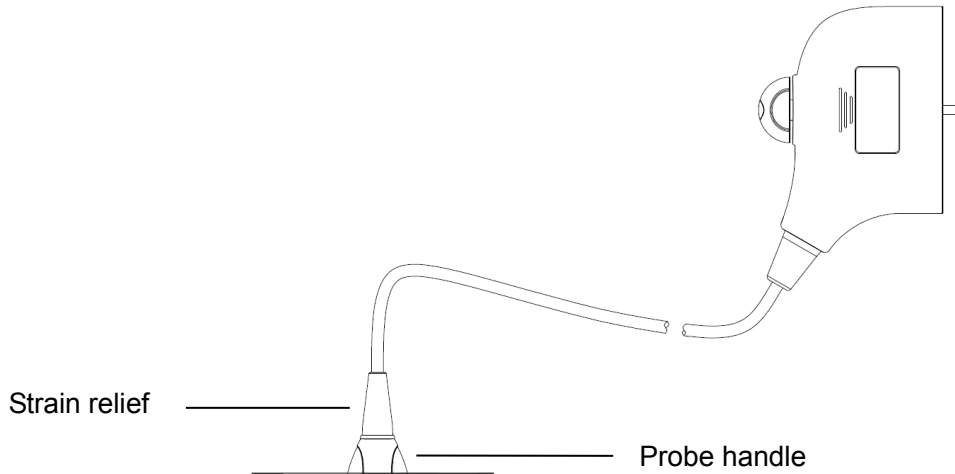

NOTE:

1. Observe the graph here carefully to immerse the transducer. Only soak parts of the transducer below the strain relief.
2. Repeated disinfection will eventually damage the probe, please check the probe performance periodically.

Compatible Disinfectants

For the disinfectants information, please refer to Disinfectant Quick Reference.

5.3 Sterilization

For intra-operative transducers, they have to be sterilized after completing each examination.

1. Wear sterile gloves to prevent infection.
2. Clean the transducer before sterilizing it. MINDRAY recommends the following solutions to sterilize the transducer.

Hydrogen Peroxide and Peroxyacetic Acid -based sterilization solution

Trade Name	Chemical Name	Procedures
Minnicare® Cold Sterilant	22% Hydrogen Peroxide 4.5% Peroxyacetic Acid	Dilute the sterilant with sterilized purified water (1:20). Immersed time: 11 hours. Temperature: 20°C-25°C. Please refer to the instructions provided by the manufacturer of the solution for details.

Glutaraldehyde-based sterilization solution

Trade Name	Chemical Name	Procedures
Cidex Activated Glutaraldehyde Solution (applicable for CE region)	2.2-2.7% Glutaraldehyde	Soak the transducer into the activated solution for 10 hours (20-25°C).
Cidex Activated Dialdehyde Solution (applicable for FDA region)	2.4% Glutaraldehyde	Please refer to the instructions provided by the manufacturer of the solution for details.

- Refer to the instructions provided by the chemical manufacturer concerning concentration of the sterilization solution, method of sterilization and dilution and cautions during use.
 - Do not soak the transducer connector or the cable near it into water or any solution.
 - Follow local regulations when selecting and using the sterilization solution.
3. Rinse the transducer with plenty of sterile water (about 2 gallons) for at least 1 minute to remove all chemical residues on it. Or, follow the rinsing method recommended by the sterilization solution manufacturer to rinse the transducer.
 4. Wipe off the water on the transducer with sterile cloth or gauze after rinsing it. Do not dry the transducer by heating.

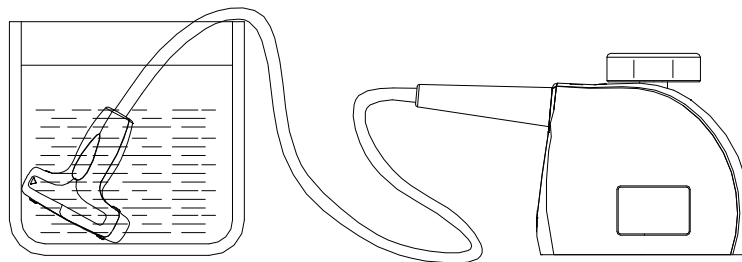

Immerse the intra-operative transducer in the solution (for reference)

Before safety and performance is affected, intra-operative probes can be sterilized by Cidex Activated Glutaraldehyde Solution for at least 217 times (10 hours for one time).
 Before safety and performance is affected, intra-operative probes can be sterilized by Minncare COLD STERILANT for at least 135 times (11 hours for one time).

⚠ CAUTION: Repeated disinfection will eventually damage the transducer, please check the transducer's performance periodically.

6 Needle-guided Bracket and Biopsy

For details about the needle-guided bracket and biopsy operations, please refer to the needle-guided bracket operator's manual.

7 Storage and Transportation

Note: For details of storage time and condition for disinfected probes or sterilized probes, please refer to Technical standard for Disinfection of Medical and Health Structures.

When all examinations for the day have been completed, confirm that the transducer is in good condition and store it in a suitable place so that the next examination can be conducted smoothly.

- To prevent the transducer from being damaged, do not store it in locations where it may be exposed to:

- Direct sunlight or X-rays
- Sudden changes in temperature
- Dust
- Excessive vibration
- Heat generators

- Store and transport the transducers under the following ambient conditions:

For black/white ultrasound system applied transducers:

- Ambient temperature: $-20^{\circ}\text{C}\sim 55^{\circ}\text{C}$
- Relative humidity: 30% to 95% (no condensation)
- Atmospheric pressure: 700 hPa to 1060 hPa

For Doppler ultrasound system applied transducers:

- Ambient temperature: $-20^{\circ}\text{C}\sim 55^{\circ}\text{C}$
- Relative humidity: 30% to 95% (no condensation)
- Atmospheric pressure: 700 hPa to 1060 hPa

Store and transport the SP5-1s/SP5-1E/LM14-6E/LM14-6s/G6-2Gs/C6-2 probe under the following ambient conditions:

- Ambient temperature: $-20^{\circ}\text{C}\sim 55^{\circ}\text{C}$
- Relative humidity: 20% to 95% (no condensation)
- Atmospheric pressure: 700 hPa to 1060 hPa

Store and transport the L16-4HE/L16-4Hs/L16-4HU/L14-5sp probe under the following ambient conditions:

- Ambient temperature: 0°C to 60°C
- Relative humidity: 30% to 95% (no condensation)
- Atmospheric pressure: 700 hPa to 1060 hPa

Store and transport the SC5-1E probe under the following ambient conditions:

- Ambient temperature: -10°C to 60°C
- Relative humidity: 20% to 95% (no condensation)
- Atmospheric pressure: 700 hPa to 1060 hPa

Store and transport the L10-3E/L10-3s probe under the following ambient conditions:

- Ambient temperature: -34°C to 65°C
- Relative humidity: 15% to 95% (no condensation)
- Atmospheric pressure: 700 hPa to 1060 hPa

Store and transport the transducers C5-1U, P7-3U and L14-6WU under the following conditions.

- Ambient temperature: -20°C ~ 55°C
- Relative humidity: 30% to 95% (no condensation)
- Atmospheric pressure: 700 hPa ~ 1060 hPa

Store and transport the transducers SP5-1U, LM16-4U, V11-3HU, L11-3U, L9-3U, P10-4U, SC6-1U, C6-2GU, L9-3E, V11-3HE and C11-3U under the following conditions.

- Ambient temperature: -20°C ~ 55°C
- Relative humidity: 20% to 95% (no condensation)
- Atmospheric pressure: 700 hPa ~ 1060 hPa

Store and transport the transducer SC8-2U under following ambient conditions:

- Ambient temperature: -10°C ~ 60°C
- Relative humidity: 10% to 90% (no condensation)
- Atmospheric pressure: 700 hPa ~ 1060 hPa

Store and transport the transducer SC5-1U under following ambient conditions:

- Ambient temperature: -10°C ~ 60°C
- Relative humidity: 20% to 95% (no condensation)
- Atmospheric pressure: 700 hPa ~ 1060 hPa

Store and transport the transducer L20-5U, L14-5WU, L20-5E and C4-1U under following ambient conditions:

- Ambient temperature: -20°C ~ 60°C
- Relative humidity: 15% to 90% (no condensation)
- Atmospheric pressure: 500 hPa ~ 1060 hPa

Store and transport the 6LB7E probe under the following ambient conditions:

- Ambient temperature: -20°C to 60°C
- Relative humidity: 30% to 95% (no condensation)
- Atmospheric pressure: 700 hPa to 1060 hPa

- When the transducer is sent to MINDRAY Customer Service Department or sales representative for repair, be sure to disinfect it and keep it in the carrying case to prevent infection.

8 Specifications

The specifications of the transducers are listed below.

No.	Model	Center Frequency	Cable Length
1.	35C50EB	3.5MHz	1950±50mm
2.	35C50P	3.5MHz	1950 ± 50mm
3.	65EC10EB	6.5MHz	1950±50mm
4.	75L38EB	7.5MHz	1950±50mm
5.	75L38P	7.5MHz	1950 ± 50mm
6.	65C15EA	6.5MHz	1950±50mm
7.	75L60EA	7.5MHz	1950±50mm
8.	35C20EA	3.5MHz	1950±50mm
9.	65C15EAV	6.5MHz	1950±50mm
10.	75L50EAV	7.5MHz	2690±50mm
11.	50L60EAV	5.0MHz	2690±50mm
12.	35C50EA	3.5MHz	1950±50mm
13.	65EC10EA	6.5MHz	1950±50mm
14.	75L38EA	7.5MHz	1950±50mm
15.	65EL60EA	6.5MHz	1950±50mm
16.	75L53EA	7.5MHz	1950±50mm
17.	75LT38EA	7.5MHz	1950±50mm
18.	35C50HA	3.5MHz	1950±50mm
19.	35C20HA	3.5MHz	1950±50mm
20.	65EC10HA	6.5MHz	1950±50mm
21.	65C15HA	6.5MHz	1950±50mm
22.	75L38HA	7.5MHz	1950±50mm
23.	75L38HB	7.5MHz	1950±50mm
24.	75L60HB	7.5MHz	1950±50mm
25.	65EC10EC	6.5MHz	1950±50mm
26.	65EC10ED	6.5MHz	1950±50mm
27.	65L50HAV	6.5MHz	3000mm±50mm

No.	Model	Center Frequency	Cable Length
28.	65EL66HA	6.5MHz	1950±50mm
29.	75LT40HA	7.5MHz	1950±50mm
30.	75L53HA	7.5MHz	1950±50mm
31.	65EC10HC	6.5MHz	1950±50mm
32.	65EC10HD	6.5MHz	1950±50mm
33.	6LE5V	6.5MHz	2690±50mm
34.	6LE5Vs	6.5MHz	2790±50mm
35.	6LE7/6LE7P	6.5MHz	1950±50mm
36.	6LE7s	6.5MHz	2050±50mm
37.	65EB10EA	6.5MHz	1950±50mm
38.	10L24EA	10MHz	1950±50mm
39.	6LB7	Convex: 6.5MHz	1950±50mm
		Linear: 6.5MHz	
40.	6LB7s	Convex: 6.5MHz	2050±50mm
		Linear: 6.5MHz	
41.			
42.	10L4	10.0MHz	1950±50mm
43.	10L4s	10.0MHz	2050±50mm
44.	7L4	7.5MHz	1950±50mm
45.	7L4s	7.5MHz	2050±50mm
46.	7L6	7.5MHz	1950±50mm
47.	7L6s	7.5MHz	2050±50mm
48.	6CV1/6CV1P	6.5MHz	1950±50mm
49.	6CV1s	6.5MHz	2050±50mm
50.	3C1	3.5MHz	1950±50mm
51.	3C1s	3.5MHz	2050±50mm
52.	3C5/3C5P	3.5MHz	1950±50mm
53.	3C5s	3.5MHz	2050±50mm
54.	3C5A	3.5MHz	1950±50mm
55.	C5-2	3.5MHz	1950±50mm
56.	C5-2s	3.5MHz	2050±50mm
57.	V10-4/V10-4BP	6.5MHz	1950±50mm
58.	V10-4s	6.5MHz	2050±50mm

No.	Model	Center Frequency	Cable Length
59.	V10-4B	6.5MHz	1950±50mm
60.	V10-4Bs	6.5MHz	2050±50mm
61.	6C2/6C2P	6.5MHz	1950±50mm
62.	6C2s	6.5MHz	2050±50mm
63.	7L4A/7L4P	7.5MHz	1950±50mm
64.	L11-4	7.5MHz	1950±50mm
65.	L11-4s	7.5MHz	2050±50mm
66.	L12-4	7.5MHz	1950±50mm
67.	L12-4s	7.5MHz	2050±50mm
68.	L7-3	5MHz	1950±50mm
69.	L7-3s	5MHz	2050±50mm
70.	L14-6/ L14-6P	10MHz	1950±50mm
71.	L14-6s	10MHz	2050±50mm
72.	7L5/7L5P	7.5MHz	1950±50mm
73.	7L5s	7.5MHz	2050±50mm
74.	2P2/2P2P	3.2MHz	1950±50mm
75.	2P2s	3.2MHz	2050±50mm
76.	P7-3/ P7-3E	5.0MHz	1950±50mm
77.	P7-3s	5.0MHz	2050±50mm
78.	P12-4	8.0MHz	1950±50mm
79.	P12-4s	8.0MHz	2050±50mm
80.	P4-2	2.9MHz	1950±50mm
81.	P4-2s	2.9MHz	2050±50mm
82.	7LT4/7LT4P	7.5MHz	1950±50mm
83.	7LT4s	7.5MHz	2050±50mm
84.	CB10-4/CB10-4P/CB10-4E	6.5MHz	1950±50mm
85.	L14-6Ns	10MHz	2050±50mm
86.	CW2s	2MHz	2100±50mm
87.	C5-2E	3.5MHz	1950±50mm
88.	C7-3E	5MHz	1950±50mm
89.	L12-3E	7.5MHz	1950±50mm
90.	L14-6NE	10MHz	1950±50mm

No.	Model	Center Frequency	Cable Length
91.	L14-6WE	10MHz	1950±50mm
92.	P4-2E	3MHz	1950±50mm
93.	V11-3E	6.5MHz	1950±50mm
94.	CW5	5MHz	1610±50mm
95.	CW5s	5MHz	2050±50mm
96.	C11-3E	6.5MHz	1950 ± 50mm
97.	C11-3s	6.5MHz	2050±50mm
98.	V11-3BE	6.5MHz	1950 ± 50mm
99.	V11-3WE	6.5MHz	1950 ± 50mm
100.	V11-3Ws	6.5MHz	2050±50mm
101.	L7-3E	5.0MHz	1950 ± 50mm
102.	P10-4E	6.5MHz	1950 ± 50mm
103.	P10-4s	6.5MHz	2050±50mm
104.	P4-2NE	3.0MHz	1950 ± 50mm
105.	C5-1s	3.1MHz	2050±50mm
106.	SP5-1s	3.0MHz	2050±50mm
107.	LM14-6E	10.0MHz	2200±50mm
108.	SC5-1E	3.2MHz	2200±50mm
109.	SP5-1E	3.0MHz	2200±50mm
110.	L10-3E	6.5MHz	2000±200mm
111.	L16-4HE	10.0MHz	2200±50mm
112.	LM14-6s	10.0MHz	2050 ± 50mm
113.	C6-2Gs	4.0MHz	2790 ± 50mm
114.	L16-4Hs	10MHz	2050 ± 50mm
115.	L14-6Ws	10.0MHz	2050 ± 50mm
116.	L10-3s	6.5MHz	2050 ± 50mm
117.	V11-3/V11-3B	6.5MHz	1950 ± 50mm
118.	C5-1U	3.0MHz	1950 ± 50mm
119.	SC8-2U	4.5MHz	1950 ± 50mm
120.	V11-3HU	6.5MHz	1950 ± 50mm
121.	L14-6WU	10.0MHz	1950 ± 50mm

No.	Model	Center Frequency	Cable Length
122.	L11-3U	7.0MHz	1950 ± 50mm
123.	SP5-1U	3.0MHz	1950 ± 50mm
124.	LM16-4U	10.0MHz	1950 ± 50mm
125.	SC5-1U	3.0MHz	1950 ± 50mm
126.	L20-5U	13.5MHz	1950 ± 50mm
127.	C5-1E	3.0MHz	1950 ± 50mm
128.	L9-3U	6.0MHz	1950 ± 50mm
129.	L14-5WU	9.0MHz	1950 ± 50mm
130.	C6-2	4.0MHz	1950 ± 50mm
131.	SC6-1U	3.5MHz	1950 ± 50mm
132.	P10-4U	6.5MHz	1950 ± 50mm
133.	C6-2GU	4.0MHz	1950 ± 50mm
134.	C11-3U	6.2MHz	1950 ± 50mm
135.	P7-3U	5.0MHz	1950±50mm
136.	L16-4HU	9.0MHz	2050 ± 50mm
137.	C4-1U	2.3MHz	1950 ± 50mm
138.	V11-3HE	6.5MHz	1950 ± 50mm
139.	L9-3E	5.5MHz	1950 ± 50mm
140.	L14-5sp	9.5MHz	1950 ± 50mm
141.	L20-5E	13.5MHz	1950 ± 50mm
142.	6LB7E	6.5MHz	1950 ± 50mm

Operation ambient environment:

The Matched Ultrasound System	Temperature	Relative Humidity	Atmospheric Pressure
Black/white ultrasound system	0°C~40°C	30%~90%	700 hPa~1060 hPa
Doppler ultrasound system	0°C~40°C	30%~85%	700 hPa~1060 hPa
	10°C~40°C (L16-4HE/L10-3E/L10-3s/L16-4HU)	30%~85%	700 hPa~1060 hPa

The Matched Ultrasound System	Temperature	Relative Humidity	Atmospheric Pressure
	0°C~40°C	20%~85% (SP5-1E/LM14-6E/LM14-6s/C6-2Gs/SP5-1U/LM16-4U/V11-3HU/L11-3U/L9-3U/C6-2/P10-4U/C6-2GU/C11-3U/SC6-1U/L9-3E/V11-3HE)	700 hPa~1060 hPa
	0°C~35°C(L20-5U/L14-5WU/C4-1U/L20-5E)	15%~80%	700 hPa~1060 hPa
	18°C~30°C(D8-4U)	30%~75%	700 hPa~1060 hPa
	18°C~30°C(DE10-3U)	20%~85%	700 hPa~1060 hPa

