

**M5Vet Diagnostic Ultrasound System**

# **Operator's Manual**

**[Basic Volume]**



# Table of Contents

<b>Table of Contents</b> .....	<b>i</b>
<b>Intellectual Property Statement</b> .....	<b>II</b>
<b>Important Information</b> .....	<b>V</b>
<b>Introduction</b> .....	<b>VI</b>
<b>Safety Precautions</b> .....	<b>VII</b>
<b>1 Overview</b> .....	<b>1-1</b>
1.1 Intended Use .....	1-1
1.2 Product and Model Code .....	1-1
<b>2 Product Specifications</b> .....	<b>2-1</b>
2.1 Imaging Modes .....	2-1
2.2 Power Supply (Adapter) .....	2-1
2.3 Environmental Conditions .....	2-1
2.4 External Dimensions and Weight .....	2-1
<b>3 System Configuration</b> .....	<b>3-1</b>
3.1 Standard Configuration .....	3-1
3.2 Probes and Needle-guided Brackets Available .....	3-1
3.3 Optional Units .....	3-3
3.4 Peripheral Devices Supported .....	3-4
<b>4 System Introduction</b> .....	<b>4-1</b>
4.1 Introduction of Each Unit .....	4-1
4.2 Extend Modules .....	4-3
4.2.1 Probe Extend Module .....	4-3
4.2.2 IO Extend Module .....	4-4
4.2.3 V/A Extend Module .....	4-5
4.2.4 ECG Module .....	4-5
4.3 Control Panel .....	4-6
4.4 Symbols .....	4-12
<b>5 Set-up &amp; Connections</b> .....	<b>5-1</b>
5.1 System Set-up .....	5-1
5.2 Power Supply .....	5-1
5.2.1 Connecting the External Power Supply .....	5-1
5.2.2 Powered by Batteries .....	5-2
5.3 Connecting / Disconnecting a Transducer .....	5-2

5.3.1	Connect a Transducer .....	5-2
5.3.2	Disconnect a Transducer .....	5-3
5.4	Connecting the Probe Extend Module .....	5-3
5.5	Connecting IO Extend Module .....	5-4
5.6	Connecting the V/A Extend Module.....	5-4
5.7	Connecting the ECG Module.....	5-5
5.8	Connecting the Footswitch .....	5-5
5.9	Connecting / Removing a USB Memory Device .....	5-5
5.10	Installing a Graph / Text Printer .....	5-6
5.11	Installing a Video Printer.....	5-7
5.12	Use of M-Pack .....	5-10
5.12.1	Introduction of M-Pack.....	5-10
5.12.2	Use of M-Pack .....	5-11
<b>6</b>	<b>Power ON / OFF .....</b>	<b>6-1</b>
6.1	Powering ON the System .....	6-1
6.2	Powering OFF the System .....	6-2
<b>7</b>	<b>Basic Screen and Operation .....</b>	<b>7-1</b>
7.1	Basic Screen .....	7-1
7.1.1	Information Area.....	7-1
7.1.2	Image Parameter and Menu Area.....	7-3
7.1.3	Image-in-Image Thumbnail .....	7-3
7.1.4	Image Area.....	7-3
7.1.5	Thumbnail Area of Images Saved.....	7-3
7.1.6	Body Mark Area .....	7-4
7.1.7	Area of Help Information and Cursor Icon .....	7-4
7.1.8	Soft Menu Area .....	7-4
7.1.9	System Status Area.....	7-5
7.1.10	Measurement Result Window.....	7-5
7.2	Basic Operations of Screens.....	7-6
<b>8</b>	<b>Animal Information.....</b>	<b>8-1</b>
8.1	To Start an Exam .....	8-1
8.2	Animal Information.....	8-1
8.2.1	New Animal Information.....	8-1
8.2.2	Retrieve Animal Information from iStation.....	8-5
8.2.3	Retrieve Animal Information from Worklist.....	8-6
8.3	Pause Exam & Continue Exam .....	8-8
8.3.1	Pause Exam.....	8-8
8.3.2	Continue Exam .....	8-8

8.4	End Exam .....	8-8
8.5	Activate exam .....	8-9
8.6	Cancel an exam.....	8-9
8.7	Anonymous Animal Exam .....	8-9
<b>9</b>	<b>Exam Types.....</b>	<b>9-1</b>
9.1	Introduction of Exam Types.....	9-1
9.2	Selecting Transducer and Exam Type.....	9-1
9.3	Setting Exam Types.....	9-2
9.3.1	Exam Selection .....	9-3
9.3.2	Exam Configuration .....	9-4
9.3.3	User-defined Exam Types.....	9-5
<b>10</b>	<b>Image Modes.....</b>	<b>10-1</b>
10.1	Image Modes.....	10-1
10.2	Switching Between Image Modes .....	10-1
10.3	Image Adjustments .....	10-2
10.3.1	B Mode.....	10-4
10.3.2	M Mode .....	10-9
10.3.3	Color Mode .....	10-10
10.3.4	Power / DirPower Mode .....	10-13
10.3.5	PW/CW Doppler Mode .....	10-14
10.3.6	Image Magnification.....	10-18
10.3.7	iZoom (Full-screen Zooming).....	10-18
10.4	Image Parameter Preset .....	10-18
<b>11</b>	<b>Special Imaging Modes.....</b>	<b>11-1</b>
11.1	Smart3D .....	11-1
11.1.1	Note before Use.....	11-1
11.1.2	Smart3D Preset .....	11-2
11.1.3	Enter/ Exit Smart3D .....	11-4
11.1.4	3D Image Acquisition Preparation .....	11-5
11.1.5	Image Acquisition.....	11-6
11.1.6	3D Image Browsing .....	11-6
11.1.7	Reset ROI .....	11-13
11.1.8	3D Images Storage and Review .....	11-14
11.2	iScape.....	11-15
11.2.1	Enter or Exit iScape .....	11-15
11.2.2	Capture Images .....	11-16
11.2.3	Review the Extended Image.....	11-16
11.2.4	Review the Captured Images Frame by Frame.....	11-17

11.2.5	Save and Open Images .....	11-17
11.3	Free Xros M Mode .....	11-18
11.3.1	Settings for Free Xros M .....	11-18
11.3.2	Enter/Exit Free Xros M .....	11-18
11.3.3	Imaging .....	11-18
11.3.4	Free Xros M Image Parameters .....	11-19
<b>12</b>	<b>Cine Review .....</b>	<b>12-1</b>
12.1	Entering / Exiting Cine Review .....	12-1
12.2	Cine Review in the B or C Mode .....	12-1
12.2.1	Manual Cine Review .....	12-1
12.2.2	Auto Cine Review .....	12-2
12.3	Cine Review in the M or D Mode .....	12-2
12.4	Linked Cine Review .....	12-2
12.5	Setting Region of Auto Review .....	12-3
12.6	Saving Cine .....	12-4
12.7	Cine Setup .....	12-4
12.7.1	Setting Cine Length .....	12-4
12.7.2	Setting Cine Memory Split .....	12-4
<b>13</b>	<b>Measurements .....</b>	<b>13-1</b>
13.1	Basic Operations .....	13-1
13.1.1	Enter Measurement Status .....	13-1
13.1.2	Measurement Result and Help Information .....	13-1
13.2	General Measurements .....	13-2
13.2.1	General Measurements – 2D .....	13-2
13.2.2	General Measurements - M Mode .....	13-2
13.2.3	General Measurements - Doppler .....	13-3
13.3	Application Measurements .....	13-3
<b>14</b>	<b>Comments (Annotations).....</b>	<b>14-1</b>
14.1	Entering / Exiting Comments .....	14-1
14.2	Comment Menu .....	14-1
14.2.1	Comment Text Library Menu .....	14-1
14.2.2	Soft Menu for Comments .....	14-2
14.3	Adding Comments .....	14-3
14.3.1	Typing Comment Characters .....	14-3
14.3.2	Adding a Comment Text .....	14-3
14.3.3	Adding an Arrow .....	14-4
14.4	Moving Comments .....	14-4
14.5	Modifying (Editing) Comments .....	14-5

14.5.1	Modifying (Editing) Characters .....	14-5
14.5.2	Modifying (Editing) Arrows .....	14-5
14.6	Deleting Comments .....	14-6
14.6.1	Deleting Comment Characters, Texts or Arrows .....	14-6
14.6.2	Deleting a Recently-Added Character, Text or Arrow .....	14-6
14.6.3	Delete Word .....	14-6
14.6.4	Deleting All Comments (Characters, Texts or Arrows) .....	14-6
14.7	Comment Preset .....	14-7
14.7.1	Font Size and Arrow Size .....	14-7
14.7.2	User-defined Comments .....	14-7
<b>15</b>	<b>Body Marks (Pictograms) .....</b>	<b>15-1</b>
15.1	Entering / Exiting Body Mark Mode .....	15-1
15.2	Categories of Body Marks .....	15-1
15.3	Soft Menu for Body Marks .....	15-1
15.4	Adding Body Marks .....	15-2
15.5	Moving Body Marks .....	15-3
15.6	Deleting Body Marks .....	15-3
15.7	Body Mark Preset .....	15-4
15.7.1	Preset Exam Type Body Mark Preferences .....	15-4
<b>16</b>	<b>Data Management .....</b>	<b>16-1</b>
16.1	Animal Information Management .....	16-1
16.1.1	Enter Animal Information .....	16-1
16.1.2	Animal Information Setting .....	16-1
16.2	Image File Management .....	16-2
16.2.1	Memory Media .....	16-2
16.2.2	Image File Formats .....	16-2
16.2.3	Image Storage Preset .....	16-3
16.2.4	Saving Images to the System .....	16-3
16.2.5	Quickly Saving Images to USB Flash Drive .....	16-4
16.2.6	Quickly Saving Full Screen Image to the System .....	16-4
16.2.7	Thumbnails .....	16-5
16.2.8	Image Review and Analysis .....	16-5
16.2.9	iVision .....	16-7
16.2.10	Sending Image File .....	16-9
16.3	Report Management .....	16-10
16.4	Data Management (iStation) .....	16-11
16.4.1	Viewing Animal Information .....	16-12
16.4.2	Searching a Patient .....	16-13

16.4.3	Data Management .....	16-13
16.4.4	Examinations .....	16-14
16.5	Network Storage .....	16-15
16.5.1	Network Storage Setting .....	16-15
16.5.2	Network Storage .....	16-16
16.6	Print Task Management .....	16-16
16.7	Backing Up and Erasing Files through DVD Drive .....	16-17
16.8	Task manager .....	16-18
16.9	Reviewing the AVI Files .....	16-20
16.10	Admin .....	16-20
16.10.1	Access Setting .....	16-20
16.10.2	Setting Access Control .....	16-20
16.10.3	System Login .....	16-20
16.10.4	Add/ Delete a User .....	16-21
16.10.5	Modify Password .....	16-23
<b>17</b>	<b>Parameter Setup .....</b>	<b>17-1</b>
17.1	Entering / Exiting Setup .....	17-1
17.2	System Setup .....	17-2
17.3	Exam Mode Preset .....	17-5
17.4	Image Parameter Preset .....	17-5
17.5	Comment Preset .....	17-5
17.6	Body Mark Preset .....	17-5
17.7	Measurement Preset .....	17-5
17.8	Soft-Key and Menu Preset .....	17-5
17.9	Peripheral Setup .....	17-8
17.10	Network Storage .....	17-11
17.11	Manage Settings .....	17-11
17.11.1	Exporting Setup Data .....	17-11
17.11.2	Importing Setup Data .....	17-11
17.12	Maintenance .....	17-11
17.13	System Information .....	17-12
<b>18</b>	<b>Probes and Biopsy .....</b>	<b>18-1</b>
18.1	Probes .....	18-1
18.1.1	Name and Function of Each Part of the Probe .....	18-3
18.1.2	Orientation of the Ultrasound Image and the Probe Head .....	18-7
18.1.3	Procedures for Operating .....	18-7
18.1.4	Wearing the Probe Sheath .....	18-10
18.1.5	When the Immersion Method is used (for 6LB7 and 6LE7) .....	18-11



18.1.6	Probes Cleaning and Disinfection (or Sterilization)	18-15
18.1.7	Storage and Transportation	18-19
18.2	Biopsy Guide	18-19
18.2.1	Needle-guided Brackets	18-21
18.2.2	Names of Parts	18-22
18.2.3	Needle-guided Bracket Inspection and Installation	18-36
18.2.4	Entering or Exiting Biopsy Menu	18-44
18.2.5	Displaying Biopsy Guide Lines	18-45
18.2.6	Verifying the Biopsy Guide Line	18-45
18.2.7	Removing the Needle-guided Bracket	18-46
18.2.8	Clean and Sterilize the Needle-guided Bracket	18-50
18.2.9	Storage and Transportation	18-51
18.2.10	Disposal	18-51
<b>19</b>	<b>ECG</b>	<b>19-1</b>
19.1	ECG Connection	19-1
19.2	Displaying ECG Signal	19-2
19.3	ECG Triggering	19-3
19.3.1	ECG Triggering	19-3
19.3.2	Triggering Mode	19-3
19.3.3	Real & Trigger	19-3
19.4	ECG Review	19-3
19.5	Exiting ECG	19-3
19.6	Setting ECG	19-4
<b>20</b>	<b>Image Recording</b>	<b>20-1</b>
20.1	VCR (Video Cassette Recorder)	20-1
20.1.1	Setup	20-1
20.1.2	Record	20-1
20.1.3	Replay	20-2
20.2	DVR (Digital Video Recorder)	20-4
20.2.1	Setup	20-4
20.2.2	Entering/Exiting DVR	20-4
20.2.3	Record	20-5
20.2.4	Data Management	20-6
20.2.5	Video Replay	20-7
20.3	Non-programmable Record and Replay	20-9
<b>21</b>	<b>Batteries</b>	<b>21-1</b>
21.1	Overview	21-1
21.2	Precautions	21-1

21.3	Installing and Removing the Batteries.....	21-2
21.4	Battery Status Indicator .....	21-3
21.5	One Full Discharge / Charge Cycle.....	21-4
21.6	Checking Battery Performance .....	21-4
21.7	Battery Disposal .....	21-4
<b>22</b>	<b>System Maintenance.....</b>	<b>22-1</b>
22.1	Daily Maintenance.....	22-1
22.1.1	Cleaning the System.....	22-1
22.2	Backup of the System Hard Disk.....	22-4
22.3	Maintenance Checks by Service Engineer .....	22-4
22.4	Consumables and Periodic Part Replacement .....	22-5
22.5	Troubleshooting.....	22-5
<b>23</b>	<b>Acoustic Output .....</b>	<b>23-1</b>
23.1	Concerns with Bioeffects .....	23-1
23.2	Prudent Use Statement .....	23-1
23.3	ALARA Principle (As Low As Reasonably Achievable) .....	23-1
23.4	MI/TI Explanation.....	23-2
23.4.1	Basic Knowledge of MI and TI .....	23-2
23.4.2	MI/TI Display .....	23-3
23.5	Acoustic Power Setting .....	23-3
23.6	Acoustic Power Control .....	23-4
23.7	Acoustic Output .....	23-4
23.7.1	Derated Ultrasonic Output Parameters.....	23-4
23.7.2	Limits of Acoustic Output .....	23-5
23.7.3	Differences between Actual and Displayed MI and TI .....	23-5
23.8	Measurement Uncertainty .....	23-6
23.9	References for Acoustic Power and Safety .....	23-6
<b>24</b>	<b>Measurement Accuracy .....</b>	<b>24-1</b>
<b>25</b>	<b>Safety Classification .....</b>	<b>25-1</b>
<b>26</b>	<b>Guidance and Manufacturer's Declaration .....</b>	<b>26-1</b>
<b>Appendix A</b>	<b>Wireless LAN.....</b>	<b>A-1</b>
<b>Appendix B</b>	<b>DICOM.....</b>	<b>B-1</b>
<b>Appendix C</b>	<b>Remote Control and Net Update .....</b>	<b>C-1</b>
<b>Appendix D</b>	<b>Ultrasound System Software Restoring .....</b>	<b>D-1</b>
<b>Appendix E</b>	<b>Electrical Safety Inspection .....</b>	<b>E-1</b>



© 2008-2016 Shenzhen Mindray Bio-Medical Electronics Co., Ltd. All rights Reserved.  
For this Operator's Manual, the issue date is 2016-09.

**IMPORTANT!**

**The system is veterinary use only.**

The following label applies to U.S.A. only.

**CAUTION**

**U.S.A. Federal law restricts this device to sale by or on the order of a veterinarian.**







# Intellectual Property Statement

SHENZHEN MINDRAY BIO-MEDICAL ELECTRONICS CO., LTD. (hereinafter called Mindray) owns the intellectual property rights to this Mindray product and this manual. This manual may refer to information protected by copyright or patents and does not convey any license under the patent rights or copyright of Mindray, or of others.

Mindray intends to maintain the contents of this manual as confidential information. Disclosure of the information in this manual in any manner whatsoever without the written permission of Mindray is strictly forbidden.

Release, amendment, reproduction, distribution, rental, adaptation, translation or any other derivative work of this manual in any manner whatsoever without the written permission of Mindray is strictly forbidden.

The MindrayVNC ver. 1.0 contained in this product is revised by MINDRAY on Aug, 2009, based on the UltraVNC ver. 1.0.5.5, and it complies with GNU General Public License. SHENZHEN MINDRAY BIO-MEDICAL ELECTRONICS CO., LTD. owns the intellectual property rights to the revised part. Please contact Ultrasound1.rd@mindray.com.cn for MindrayVNC ver. 1.0.

 ,  ,  ,  ,  ,  BeneView, WATO,

BeneHeart,  are the trademarks, registered or otherwise, of Mindray in China and other countries. All other trademarks that appear in this manual are used only for informational or editorial purposes. They are the property of their respective owners.

## Responsibility on the Manufacturer Party

Contents of this manual are subject to change without prior notice.

All information contained in this manual is believed to be correct. Mindray shall not be liable for errors contained herein or for incidental or consequential damages in connection with the furnishing, performance, or use of this manual.

Mindray is responsible for the effects on safety, reliability and performance of this product, only if:

- **all installation operations, expansions, changes, modifications and repairs of this product are conducted by Mindray authorized personnel;**
- **the electrical installation of the relevant room complies with the applicable national and local requirements; and**
- **the product is used in accordance with the instructions for use.**
- **MindrayVNC ver. 1.0 is free open source software, the performance of MindrayVNC ver. 1.0 is not guaranteed by MINDRAY.**

⚠ Note ⚠

This equipment must be operated by skilled/trained clinical professionals.

⚠ Warning ⚠

It is important for the hospital or organization that employs this equipment to carry out a reasonable service/maintenance plan. Neglect of this may result in machine breakdown or personal injury.

## Warranty

THIS WARRANTY IS EXCLUSIVE AND IS IN LIEU OF ALL OTHER WARRANTIES, EXPRESSED OR IMPLIED, INCLUDING WARRANTIES OF MERCHANTABILITY OR FITNESS FOR ANY PARTICULAR PURPOSE.

### Exemptions

Mindray's obligation or liability under this warranty does not include any transportation or other charges or liability for direct, indirect or consequential damages or delay resulting from the improper use or application of the product or the use of parts or accessories not approved by Mindray or repairs by people other than Mindray authorized personnel.

This warranty shall not extend to:

- **Malfunction or damage caused by improper use or man-made failure.**
- **Malfunction or damage caused by unstable or out-of-range power input.**
- **Malfunction or damage caused by force majeure such as fire and earthquake.**
- **Malfunction or damage caused by improper operation or repair by unqualified or unauthorized service people.**
- **Malfunction of the instrument or part whose serial number is not legible enough.**
- **Others not caused by instrument or part itself.**

**For the standard warranty period in different region, please contact your distributor.**

# Company Contacts

## Mindray Headquarters

**Manufacturer:** Shenzhen Mindray Bio-Medical Electronics Co., Ltd.  
**Address:** Mindray Building, Keji 12th Road South, High-tech industrial park, Nanshan, Shenzhen 518057, P.R.China  
**Website:** [www.mindray.com](http://www.mindray.com)  
**E-mail Address:** service@mindray.com  
**Tel:** +86 755 81888998  
**Fax:** +86 755 26582680

**EC-Representative:** Shanghai International Holding Corp. GmbH(Europe)

**Address:** Eiffestraße 80, Hamburg 20537, Germany

**Tel:** 0049-40-2513175

**Fax:** 0049-40-255726

Mindray DS USA, Inc.  
800 MacArthur Blvd.  
Mahwah, NJ 07430-0619 USA  
Tel: +1(201) 995-8000  
Toll Free: +1 (800) 288-2121  
Fax: +1 (800) 926-4275

# Important Information

1. It is the customer's responsibility to maintain and manage the system after delivery.
2. The warranty does not cover the following items, even during the warranty period:
  - a. Damage or loss due to misuse or abuse.
  - b. Damage or loss caused by Acts of God such as fires, earthquakes, floods, lightning, etc.
  - c. Damage or loss caused by failure to meet the specified conditions for this system, such as inadequate power supply, improper installation or environmental conditions.
  - d. Damage or loss due to use of the system outside the region where the system was originally sold.
  - e. Damage or loss involving the system purchased from a source other than Mindray or its authorized agents.
3. This system shall not be used by persons other than fully qualified and certified medical personnel.
4. Do not make changes or modifications to the software or hardware of this system.
5. In no event shall Mindray be liable for problems, damage, or loss caused by relocation, modification, or repair performed by personnel other than those designated by Mindray.
6. The purpose of this system is to provide physicians with data for clinical diagnosis.  
It is the physician's responsibility for diagnostic procedures. Mindray shall not be liable for the results of diagnostic procedures.
7. Important data must be backed up on external memory media.
8. Mindray shall not be liable for loss of data stored in the memory of this system caused by operator error or accidents.
9. This manual contains warnings regarding foreseeable potential dangers, but you shall always be alert to dangers other than those indicated as well. Mindray shall not be liable for damage or loss that results from negligence or from ignoring the precautions and operating instructions described in this operator's manual.
10. If the manager for this system is changed, be sure to hand over this operator's manual to the new manager.

# Introduction

This operator's manual describes the operating procedures for this diagnostic ultrasound system. To ensure safe and correct operations, carefully read and understand the manual before operating the system.

## 1. Notation Conventions

In this operator's manual, the following words are used besides the safety precautions (refer to "Safety Precautions"). Please read this operator's manual before using the system.

<b>NOTE:</b>	Indicates information of interest to users of this system as to exceptional conditions or operating procedures.
--------------	---

<b>⚠ CAUTION:</b>	<b>1</b>	<b>United States federal law restricts this device to be sale by or on the order of a physician.</b>
	<b>2</b>	<b>The diagnostic ultrasound system is not intended for ophthalmic use. Its use in this clinical specialty is contraindicated.</b>

## 2. Operator's Manuals

Please read the operator's manuals carefully before operating the system. The operator's manuals accompanied with this system include those of the main unit and transducers.

Operator's manuals of the main unit: <ul style="list-style-type: none"><li>● Basic Volume</li><li>● Advanced Volume</li><li>● Operation Note</li></ul>	Describe detailed system information on preparation, operating procedures, maintenance checks, and functions.
--	---



## 3. Screens in This Operator's Manual



Screens or menus may vary depending upon the software version and configuration of your purchased ultrasound system.







# Safety Precautions

## 1. Meaning of Signal Words

In this operator's manual, the signal words  **DANGER**,  **WARNING**,  **CAUTION** and **NOTE** are used regarding safety and other important instructions. The signal words and their meanings are defined as follows. Please understand their meaning before reading this manual.

Signal word	Meaning
 <b>DANGER</b>	Indicates an imminently hazardous situation that, if not avoided, will result in death or serious injury.
 <b>WARNING</b>	Indicates a potentially hazardous situation that, if not avoided, could result in death or serious injury.
 <b>CAUTION</b>	Indicates a potentially hazardous situation that, if not avoided, may result in minor or moderate injury.
<b>NOTE</b>	Indicates a potentially hazardous situation that, if not avoided, may result in property damage.

## 2. Meaning of Safety Symbols

Symbol	Description
	Type-BF applied part The ultrasound transducers connected to this system are Type-BF applied parts. The ECG module connected to this system is Type-BF applied part.
	Caution
	Patient/user infection due to contaminated equipment. Be careful when performing the cleaning, disinfection and sterilization.
	Patient injury or tissue damage from ultrasound radiation. It is required to practice ALARA when operating ultrasound system.

### 3. Safety Precautions

Please observe the following precautions to ensure animal's and operator's safety when using this system.

**⚠ DANGER:** Do not use flammable gasses, such as anesthetic gas, oxygen or hydrogen, or flammable liquids such as ethanol, near this system and probes, because there is danger of explosion.

- ⚠ WARNING:**
- 1 Do not connect the adapter power plug of this system and power plugs of the peripherals to wall receptacles that meet the ratings indicated on the rating nameplate. Using a multifunctional receptacle may affect the system grounding performance, and cause the leakage current to exceed safety requirements. You must use the power adapter provided with the system; otherwise electric shock may result.**
  - 2 Use the printing cable provided with this system to connect the printer. Otherwise, electric shock may result.**
  - 3 Connect the grounding terminal before turning ON the system. Disconnect the grounding cable after turning OFF the system. Otherwise, electric shock may result.**
  - 4 For the connection of power and grounding, follow the appropriate procedures described in this operator's manual. Otherwise, there is risk of electric shock. Do not connect the grounding cable to a gas pipe or water pipe; otherwise improper grounding may result or a gas explosion may occur.**
  - 5 Before cleaning the system, disconnect the power cord from the receptacle. System failure and electric shock may result.**
  - 6 This system is not water-proof. Do not use this system in any place where water leakage may occur. If any water is sprayed on or into the system, electric shock may result. If water is accidentally sprayed on or into the system, contact Mindray Customer Service Department or sales representative.**

- 7 Store and use the transducers carefully. Do not use a transducer that has a damaged, scratched surface, or exposed wiring of any kind. Immediately stop using the transducer and contact Mindray Customer Service Department or sales representative.**
- 8 Do not allow the animal to contact the live parts of the ultrasound system or other devices, e.g. signal I / O ports. Electric shock may occur.**
- 9 Do not use an aftermarket transducer other than those specified by Mindray. The transducers may damage the system causing a profound failure, e.g. a fire in the worst case.**
- 10 Do not subject the transducers to knocks or drops. Use of a defective transducer may cause an electric shock.**
- 11 Do not open the covers and front panel of the system. Short circuit or electric shock may result when the system hardware is exposed and powered on.**
- 12 Do not use this system simultaneously with equipment such as an electrosurgical unit, high-frequency therapy equipment, or a defibrillator, etc.; otherwise electric shock may result.**
- 13 Only use the ECG leads provided with the ECG module; otherwise electric shock may result.**
- 14 When moving the system, you should first fold the LCD display, disconnect the system from other devices (including transducers) and disconnect the system from the power supply.**

**15** Accessory equipment connected to the analog and digital interfaces must comply with the relevant IEC standards (e.g., IEC 60950 information technology equipment safety standard and IEC 60601-1 medical equipment standard). Furthermore all configurations must comply with the standard IEC60601-1-1. It is the responsibility of the person, who connects additional equipment to the signal input or output ports and configures a medical system, to verify that the system complies with the requirements of IEC60601-1-1. If you have any questions regarding these requirements, consult your sales representative.

**16** Prolonged and repeated use of keyboards may result in hand or arm nerve disorders for some individuals. Observe the local safety or health regulations concerning the use of keyboards.

 **CAUTION:**

**1** Precautions concerning clinical examination techniques:

- 1)** This system must be used only by qualified medical professionals.
- 2)** This operator's manual does not describe clinical examination techniques. The clinician should select the proper examination techniques based on specialized training and clinical experience.

**2** Malfunctions due to radio wave:

- 1)** If a radio wave emitting device is used in the proximity of this system, it may interfere with operations. Do not bring or use devices that generate radio waves, such as cellular telephones, transceivers, and radio controlled toys, in the room where the system is installed.
- 2)** If a person brings a device that generates radio waves near the system, ask him / her to immediately turn OFF the device.

- 3 Precautions concerning movement of the system:**
- 1) When you place the system on the mobile trolley and move them together, you must secure all objects on the mobile trolley to prevent them from falling. Otherwise you should separate the system from the mobile trolley and move them individually.**  
**When you have to move the system with the mobile trolley upward or downward the stairs, you must separate them first and then move them individually.**
  - 2) Object placed on the monitor may fall and injure an individual.**
  - 3) Fasten and fully secure any peripheral device before moving the system. A loose peripheral device may fall and injure an individual.**
- 4 Do not expose the system to excessive vibration through transportation. Mechanical damage may result.**
- 5 Do not connect this system to outlets with the same circuit breakers and fuses that control the current of devices such as life-support systems. If this system malfunctions and generates overcurrent, or when there is an instantaneous current at power ON, the circuit breakers and fuses of the building's supply circuit may be tripped.**
- 6 Always keep the system dry. Avoid transporting this system quickly from a cold place to a warm place; otherwise condensation or water droplets may form allowing a short circuit and possible electric shock.**
- 7 If the circuit protector is tripped, it indicates that the system or a peripheral device is improperly shut down and the system is unstable. You cannot repair the system under this circumstance and must call the Mindray Customer Service Department or sales representative.**

- 8** There is no risk of high-temperature burns during routine ultrasound examinations. It is possible for the surface temperature of the transducer to exceed the body temperature of an animal due to environmental temperature and exam type combinations. To prevent animal burns, do not apply the transducer to the same region on the animal for a long time. Apply the transducer only for a period of time required for the purpose of diagnosis.
- 9** The system and its accessories are not disinfected or sterilized prior to delivery. The operator is responsible for the cleaning and disinfection of transducers and sterilization of biopsy brackets according to the manuals, prior to the use. All items must be thoroughly processed to completely remove harmful residual chemicals or gasses that are harmful to the animal or that may damage the accessory.
- 10** It is necessary to press [End Exam] to end the current scan that is in progress and clear the current Animal Information field. Otherwise new animal data may be combined with the previous animal data.
- 11** Do not connect or disconnect the system's power cord or its accessories (e.g., a printer or a recorder) without turning OFF the power first. This may damage the system and its accessories or cause electric shock.
- 12** Do not turn OFF the power supply of the system during printing, file storage or invoking other system operations. An interrupted process may not be completed, and can become lost or corrupted.
- 13** If the system is powered off improperly during operation, it may result in data damage of the system's hard drive or system failure.
- 14** Do not use the system to examine a fetus in the Doppler mode for a long period of time.
- 15** Do not use a USB memory device (e.g., a USB flash drive, removable hard drive) which has unsafe data. Otherwise system damage may result.

- 16 **It is recommended to only use the video devices specified in this manual.**
- 17 **Please clean the dust nets periodically (e.g. once in a month) to keep good ventilation. Otherwise, the system may be damaged.**

**NOTE:**

- 1 Do not use the system in the vicinity of strong electromagnetic field (such as a transformer), which may affect the performance of the system.
- 2 Do not use the system in the vicinity of high-frequency radiation source, which may affect the performance of the system or even lead to failure.
- 3 To avoid damaging the system, do not use it in following environment:
  - 1) Locations exposed to direct sunlight;
  - 2) Locations subject to sudden changes in environmental temperature;
  - 3) Dusty locations;
  - 4) Locations subject to vibration;
  - 5) Locations near heat generators;
  - 6) Locations with high humidity.
- 4 Turn ON the system only after the power has been turned OFF for more than 20 seconds. If the system is turned ON immediately after being turned OFF, the system may not reboot properly and could malfunction.
- 5 Do not disconnect a transducer that remains in a live imaging state. This can damage the system and / or transducer. Press [Freeze] or turn off the power of the system before connecting or disconnecting a transducer.
- 6 Remove ultrasound gel from the face of a transducer when the examination is complete. Water in the gel may enter the acoustic lens and adversely affect or damage the transducer array and lens.

- 7 You should properly back up the system to a secure external storage media, including system configuration and settings and animal data. Data stored to the system's hard drive may be lost due to system failure, improper operation or accident.
- 8 Do not apply external force to the control panel. The system may be damaged.
- 9 If the system is used in a small room, the room temperature may rise. Provide proper ventilation and free air exchange.
- 10 To dispose of the system or accessory, contact Mindray Customer Service Department or sales representative. Mindray is not responsible for any system content or accessories that have been discarded improperly.
- 11 To ensure optimal system operations, it is recommended that you maintain the system under a Mindray service agreement. Various aspects of system performance and operation can be maintained under the professional supervision of a service representative.
- 12 The iScape panoramic imaging feature constructs a single extended image from a series of individual image frames. The quality of the final image is user-dependent and requires skill to efficiently apply the feature and technique. Exercise caution when measurements are performed from an extended image.
- 13 Ensure that the current exam date and time are the same as the system date and time.

Please read the following precautions carefully to ensure the safety of the animal and the operator when using the probes.

**⚠ WARNING:**

- 1. This ultrasonic probe is only for use with the specified ultrasonic diagnostic system. Please refer to "3.2 Probes and Needle-guided Brackets Available" to select the proper probe.**
- 2. Confirm that the probe and cable are normal before and after each examination. A defective probe may cause electric shock to the animal.**
- 3. Do not subject the probe to shock. A defective probe may cause electric shock to the animal.**
- 4. Do not disassemble the probe to avoid the possibility of electric shock.**



**5. Never immerse the probe connector into liquids such as water or disinfectant because the connector is not waterproof. Immersion may cause electric shock or malfunction.**

**6. Ultrasonic probe is only for use with the specified ultrasonic diagnostic system. Please refer the ultrasonic diagnostic system operation manual to select the proper probe.**

**7. A probe sheath must be installed over the probe before performing intra-cavity or intra-operative examination.**

 **CAUTION:**

**1. When using the probe, wear sterile gloves to prevent infection.**

**2. Be sure to use ultrasound gel. Please use the ultrasound gel compliant with the relevant local regulations.**

**3. In normal diagnostic ultrasound mode, there is no danger of a normal-temperature burn; however, keeping the probe on the same region of the animal for a long time may cause such a burn.**

**4. Do not use the carrying case for storing the probe. If the carrying case is used for storage, it may become a source of infection.**

**5. The probe and accessories supplied with it are not delivered disinfected or sterilized. Sterilization (or high-level disinfect) before use is required.**

**6. It is required to practice ALARA when operating ultrasound system. Minimize the acoustic power without compromising the quality of images.**

**7. Disposable components are packaged sterile and are single-use only. Do not use if integrity of packaging violated or if expiration date has passed. Please use the disposable components compliant with the relevant local regulations.**

**8. Please use the disinfection or sterilization solution that recommended in this operator's manual; otherwise Mindray will not be liable for damage caused by other solutions. If you have any questions, please contact Mindray Customer Service Department or sales representative.**

**9. Do not use pre-lubricated condoms as a sheath. Lubricant may not be compatible with the transducer material and damage may result.**

**10. Transducer damage may be caused by inappropriate gel, detergent or cleanser:**

**Do not soak or saturate transducers with solutions containing alcohol, bleach, ammonium chloride compounds, acetone or formaldehyde.**

**Avoid contact with solutions or coupling gels containing mineral oil or lanolin.**

**NOTE:**

1. Read the following precautions to prevent the probe from malfunction.
  - Before connecting or disconnecting the probe, freeze or turn off the ultrasound diagnostic system.
  - Clean and disinfect the probe before and after each examination.
  - After the examination, wipe off the ultrasound gel thoroughly. Otherwise, the ultrasound gel may solidify and the image quality would be degraded.
2. Ambient conditions:

To prevent the probe from being damaged, do not use it where it will be exposed to:

  - direct sunlight or X-rays
  - sudden changes in temperature
  - dust
  - excessive vibration
  - heat generators

Use the probes under the specified ambient conditions.
3. Repeated disinfection will eventually damage the probe, please check the probe's performance periodically.

**NOTE:**

The following definition of the WEEE label applies to EU member states only: The use of this symbol indicates that this system should not be treated as household waste. By ensuring that this system is disposed of correctly, you will help prevent bringing potential negative consequences to the environment and human health. For more detailed information with regard to returning and recycling this system, please consult the distributor from whom you purchased the system.



\* For system products, this label may be attached to the main unit only.

#### 4. Latex Alert

<p><b>⚠ WARNING:</b></p>	<p><b>Allergic reactions in latex (natural rubber) sensitive animals may range from mild skin reactions (irritation) to fatal anaphylactic shock, and may include difficulty in breathing (wheezing), dizziness, shock, swelling of the face, hives, sneezing or itching of the eyes (FDA Medical Alert on latex products, “Allergic Reactions to Latex-containing Medical Devices”, issued on March 29, 1991).</b></p>
--------------------------	---

When choosing a transducer cover, it is recommended that you directly contact CIVCO for obtaining transducer cover, pricing information, samples and local distribution information. For CIVCO information, please contact the following:

- CIVCO Medical Instruments
- Tel: 1-800-445-6741
- [WWW.civco.com](http://WWW.civco.com)





## 5. Warning Labels

The warning labels are attached to this system in order to call your attention to potential hazards.

The warning labels use the same signal words as those used in the operator's manual.

Refer to the operator's manual for detailed information about the warning labels. Read operator's manual carefully before using the system.

The name, pattern and meaning of each warning label are described as follows:

No.	Label	Meaning
1		Please carefully read this manual before use device.
3	<p>The following labels are available when the system works with the mobile trolley.</p> 	<p>a. Do not place the device on a sloped surface. Otherwise the device may slide, resulting in personal injury or the device malfunction. Two persons are required to move the device over a sloped surface.</p> <p>b. Do not sit on the device.</p> <p>c. DO NOT push the device when the casters are locked.</p>
4	<p>The machine has only one of the certification labels below.</p> <p>Please refer to the label attached to the machine to determine the applicable certification label.</p> 	<p>The presence of this label indicates the machine was certified by ETL with the statement:</p> <p>&lt;CONFORMS TO UL 60601-1, IEC 60601-2-37, IEC60601-1-1 CERTIFIED TO CSA C22.2 No 601.1, CSA C22.2.60601.2.37, CSA C22.2 NO.60601-1-1&gt;</p>
		<p>The presence of this label indicates the machine was certified by UL with the statement:</p> <p>&lt;Medical equipment with respect to electric shock, fire and mechanical hazards only in accordance with UL60601-1, CAN/CSA-C22.2 NO.601.1-M90, IEC60601-1-1 and IEC60601-2-37.&gt;</p>

# 1 Overview

---

## 1.1 Intended Use

The diagnostic ultrasound system is intended for use in abdomen, cardiac, small parts, peripheral vascular, transrectal, intraoperative and musculoskeletal (general and superficial) exams for animals such as dog, cat, equine, bovine and ovine, etc.

## 1.2 Product and Model Code

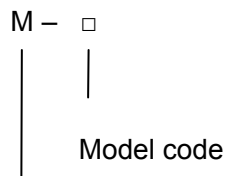

Product code

<b>NOTE:</b> The functions described in the operator's manual may vary depending upon the specific system you purchased.
--

# 2 Product Specifications

---

## 2.1 Imaging Modes

- B Mode
- M Mode
- C Mode: Color, Power or DirPower
- D Mode: PW Doppler or CW Doppler
- Special Imaging Mode: Smart3D imaging
  - iScape panoramic imaging
  - Free Xros M

## 2.2 Power Supply (Adapter)

- Power supply voltage: 100 – 240V~ (for adapter)
- Power supply frequency: 50 / 60Hz (for adapter)
- Input current : 1.5 - 0.6A (for adapter)

Power supply is intended for use in Main Unit of Diagnostic Ultrasound System. Power input 12V  $\overline{=}$  9A MAX.

## 2.3 Environmental Conditions

1	Operating conditions	
	Ambient temperature:	0°C – 40°C
	Relative humidity:	30% – 85% (no condensation)
	Atmospheric pressure:	700 hPa – 1060 hPa
2	Storage and transportation conditions	
	Ambient temperature:	-20°C – 55°C
	Relative humidity:	30% – 95% (no condensation)
	Atmospheric pressure:	700 hPa – 060 hPa

<p><b>⚠ WARNING:</b> Do not use this system in the conditions other than those specified.</p>
---

## 2.4 External Dimensions and Weight

- External dimensions:
  - 361mm long × 357mm wide × 75mm thick
- Net weight: 6.33 kg

# 3 System Configuration

---

## 3.1 Standard Configuration

- Main unit
- Drawbar Case
- Accessories

## 3.2 Probes and Needle-guided Brackets Available

Model	Type	Intended Use	Region Applied
3C5s	Convex	Small animal's reproductive system, abdomen, thorax, cardiac and urology	Body surface
3C1s	Convex	Small animal's reproductive system, abdomen, thorax, cardiac and urology	Body surface
6C2s	Convex	Small animal's reproductive system, abdomen, thorax and cardiac	Body surface
7L4s	Linear	Big animal's tendon, small animal's abdomen, small parts and eyeball	Body surface
7L6s	Linear	Big animal's tendon, small animal's abdomen, small parts and eyeball	Body surface
10L4s	Linear	Big animal's tendon, small animal's abdomen, small parts and eyeball	Body surface
6LB7s	Bi-planar	Animal's reproductive system	Transrectal
6CV1s	Convex	Animal's reproductive system	Transvaginal
6LE7s	Linear	Animal's reproductive system	Transrectal
2P2s	Phased	Small animal's abdomen, thorax and cardiac	Body surface
7LT4s	Intraoperative	Big animal's tendon, small animal's abdomen and small parts	Intraoperative; passing through body surface
7L5s	Linear	Big animal's tendon, small animal's abdomen, small parts and eyeball	Body surface
6LE5Vs	Linear	Transrectal exam for animals	Transrectal

Model	Type	Intended Use	Region Applied
L14-6s	Linear	Big animal's tendon, small animal's abdomen, small parts and eyeball	Body surface
L11-4s	Linear	Big animal's tendon, small animal's abdomen, small parts and eyeball	Body surface
P4-2s	Phased	Small animal's abdomen, thorax and cardiac	Body surface
C5-2s	Convex	Small animal's reproductive system, abdomen, thorax, cardiac and urology	Body surface

Some of the probes have matched needle-guided brackets for biopsy, the available probes and the corresponding needle-guided brackets are listed as follows:

Probe Model	Needle-guided Bracket Model	Biopsy Angle/Depth ( $\pm 1^\circ$ )	Applicable Biopsy Needle
3C5s	NGB-006 (plastic/needle detachable, metal/needle detachable)	25°, 35°, 45°	Plastic/needle detachable: 13G, 15G, 16G, 18G, 20G; Metal/needle detachable: 14G, 16G, 18G, 20G, 22G
3C1s	NGB-008: Plastic/needle-detachable; Metal/needle-detachable	11°, 23°	Metal: 14G, 16G, 18G, 20G, 22G Plastic: 13G, 15G, 16G, 18G, 20G
6CV1s	NGB-004 (metal/needle un-detachable)	/	16G, 17G, 18G
7L4s/ 7L5s/ 10L4s/ L11-4s	NGB-007 (plastic/needle detachable, metal/needle detachable)	40°, 50°, 60°	Metal/needle detachable: 14G, 16G, 18G, 20G, 22G; Plastic/needle detachable: 13G, 15G, 16G, 18G, 20G
6C2s	NGB-005 metal/needle un-detachable	12.7°, 24.2°	13G, 15G, 16G, 18G, 20G
7L6s	NGB-012 Plastic/needle-detachable; Metal/needle-detachable	40°, 50°, 60°	Metal: 14G, 16G, 18G, 20G, 22G Plastic: 13G, 15G, 16G, 18G, 20G
6LB7s/6LE7s	NGB-009 Metal/needle-detachable	/	13G, 15G, 16G, 18G, 20G
7LT4s	NGB-010 (metal/needle detachable)	30°, 40°, 50°	13G, 15G, 16G, 18G, 20G
2P2s/ P4-2s	NGB-011 (metal/needle un-detachable)	11°, 23°	13G, 15G, 16G, 18G, 20G



Probe Model	Needle-guided Bracket Model	Biopsy Angle/Depth ( $\pm 1^\circ$ )	Applicable Biopsy Needle
C5-2s	NGB-015 Metal/needle-detachable	25°, 35°, 45°	14G, 16G, 18G, 20G, 22G
L14-6s	NGB-016 (metal/needle detachable)	30°, 40°, 50°	14G, 16G, 18G, 20G, 22G

### 3.3 Optional Units

No	Name	Model
1.	DICOM basic function module(including: task management, DICOM Storage, DICOM Print, DICOM Storage Commitment, DICOM Media Storage(including DICOM DIR) etc.)	/
2.	DICOM worklist (only can be applied with the DICOM basic function module configured)	/
3.	DICOM MPPS (only can be applied with the DICOM basic function module configured)	/
4.	DICOM Query/Retrieve (only can be applied with the DICOM basic function module configured)	/
5.	CW	/
6.	ECG Module	ECG-11
7.	ECG Lead	(AHA) Part number: 0010-20-12126
		(IEC) Part number: 0010-20-12127
8.	External DVD-Writer (USB port)	DVD SE-S184M DVD SE-S204N DVD SE-S224Q
9.	I/O Extend Module	IOM-11
10.	Probe Extend Module	PEM-11
11.	Mobile Trolley	UMT 200
12.	Footswitch	971-SWNOM (IP68)
13.	iScape Kit	/
14.	Smart3D Kit	/
15.	V/A Module	VAM-11
16.	Rechargeable Li-ion Battery Pack	LI23I001A
17.	Pack	/
18.	M-Pack	/

19.	Free Xros M module	/
20.	Wireless Adapter	D-LINK DWA-125
21.	IMT Module	/

### 3.4 Peripheral Devices Supported

No	Name	Model
1	B / W video printer	Digital: MITSUBISHI P93DC, SONY UP-D897, SONY UP-D898MD, SONY UP-X898MD Analog: MITSUBISHI P93W, SONY UP-897MD
2	Color video printer	Digital: SONY UP-D23MD, SONY UP-D25MD Analog: CP31W-Z, MITSUBISHI CP910E
3	Graph / text printer (USB port)	HP OfficeJet Pro K5300 HP DeskJet 1280 HP Deskjet 6548 HP LaserJet2015d HP Business Injet 1200 HP OfficeJet J3600(HP Officejet J3608 All-in-One) HP Color LaserJet CM1015
4	VCR Recorder	Sony SVO-9500MD2

**⚠ WARNING:** This system complies with IEC60601-1-2: 2001+A1: 2004, and its RF emission meets the requirements of CISPR11 Class B. In a domestic environment, the customer or the user should guarantee to connect the system with Class B peripheral devices; otherwise RF interference may result and the customer or the user must take adequate measures accordingly.

**Note:**

1. The system may prompt an installation failure when installing drivers for HP OfficeJet J3600 (HP Officejet J3608 All-in-One) and HP Color LaserJet CM1015, this is normal, you can still print normally.
2. If the ultrasound system can not recognize the SONY UP-X898MD and SONY UP-D898MD printers automatically, you may need to change the settings on the printer: push <PUSH ENTER> to enter the main menu and select [DIGITAL]->[DRIVER], and select [897].









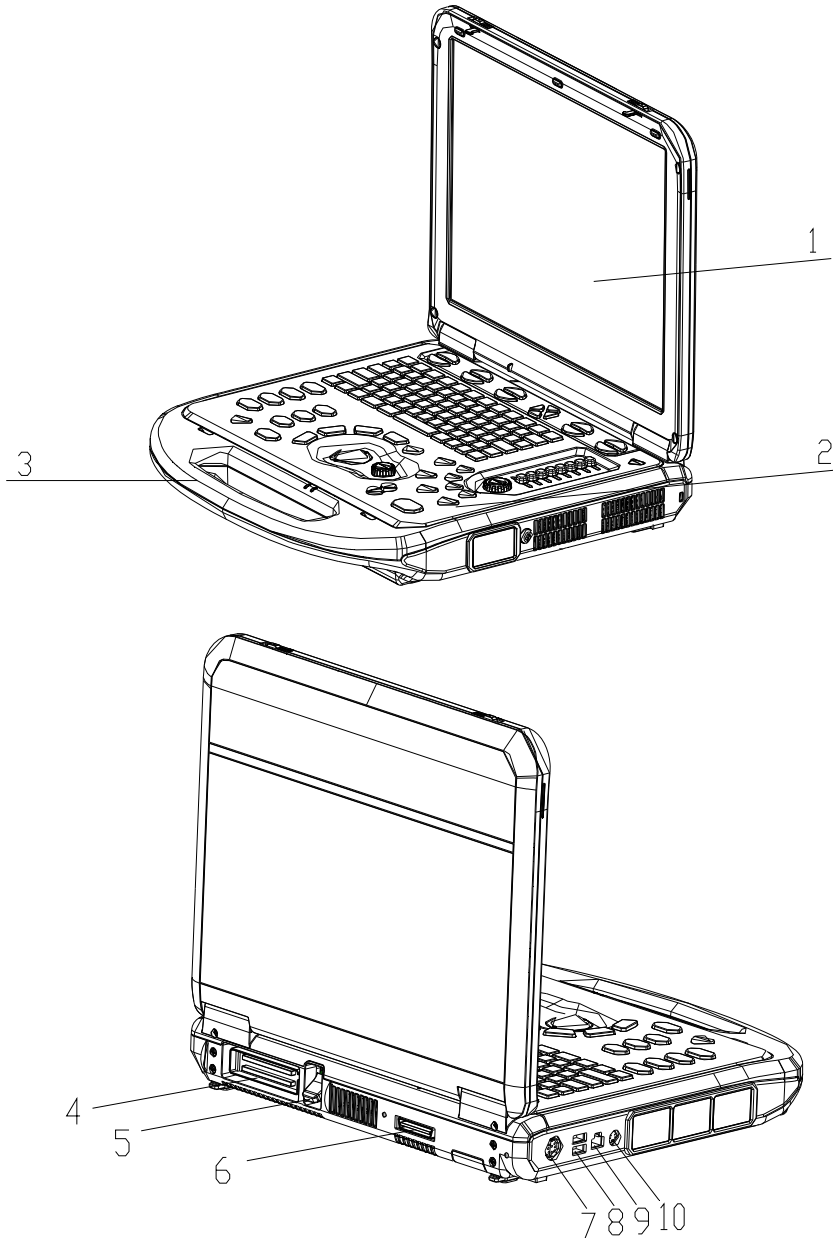

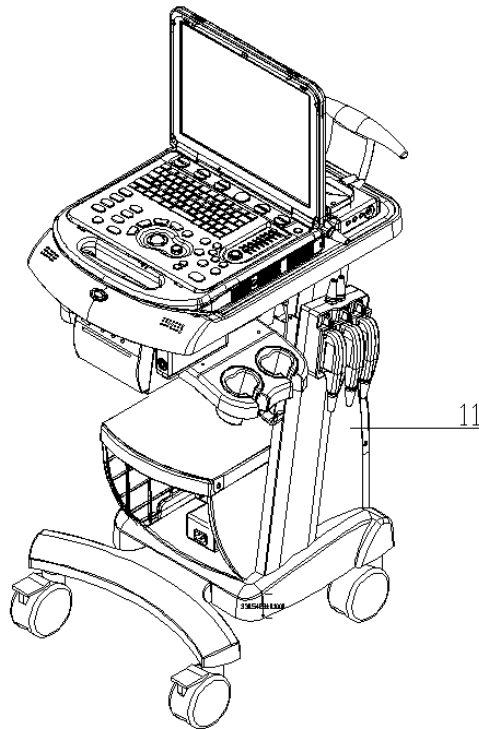
# 4 System Introduction

---

## 4.1 Introduction of Each Unit





No	Name	Function
1	Monitor	Displays the images and parameters during scanning
2	Control panel	Operator-system interface or control
3	Handle	Used for carrying the system
4	Transducer port 	Connects a transducer to the main unit; or connects the probe extend module
5	Transducer lock lever	Locks or unlocks the transducer connected with the main unit  : locked symbol  : unlocked symbol
6	IO extend port 	Connects the IO extend module
7	Power input port 12V  9A (Max. )	Connects the power adapter
8	USB port 	Connects USB devices
9	Network port 	Connects the network
10	S-Video separate video output 	Connects recorders or video printer
11	Mobile trolley	Optional device, used for placing the ultrasound system and extend modules

## 4.2 Extend Modules

There are four extend modules available for the system:

- Probe extend module
- IO extend module
- V/A extend module
- ECG module



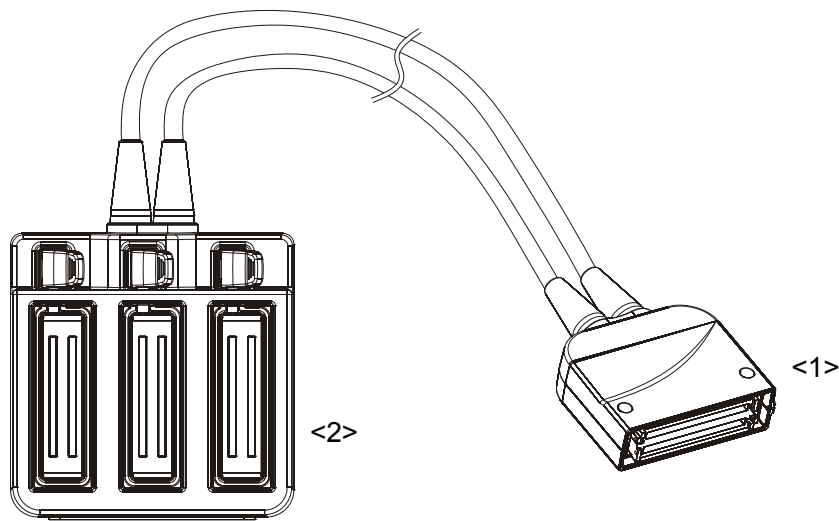



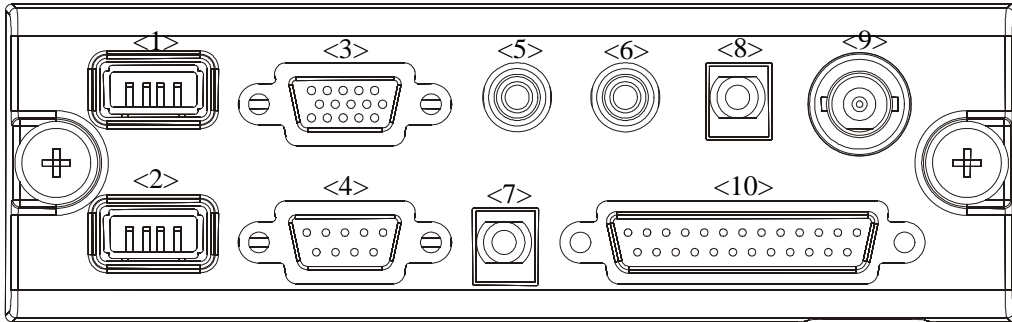

### 4.2.1 Probe Extend Module



No	Name	Function
<1>	Connector	Connects to the transducer port of the main unit
<2>	Transducer ports	Extended ports for connecting two live transducers; the middle one is a docking port.

## 4.2.2 IO Extend Module



No	Name & Symbol	Function
<1>, <2>	USB port 	Connects USB devices.
<3>	VGA output port 	Connects a display or projector
<4>	Serial port 	Connects serial port devices
<5>, <6>	Audio output port 	Used for audio signals of D mode sound from DVD output or audio comments
<7>	Mic In port 	Reserved. (Connects a microphone used for receiving audio comments when a recorder is used to record images)
<8>	Remote control port 	Connects the control port of the video printer
<9>	Composite video output port 	Used for receiving the output image signal of the video printer or recorder
<10>	Parallel port 	Reserved. (Connects the parallel port devices)

### 4.2.3 V/A Extend Module

The module is connected to the USB port of the main unit via a USB cable.

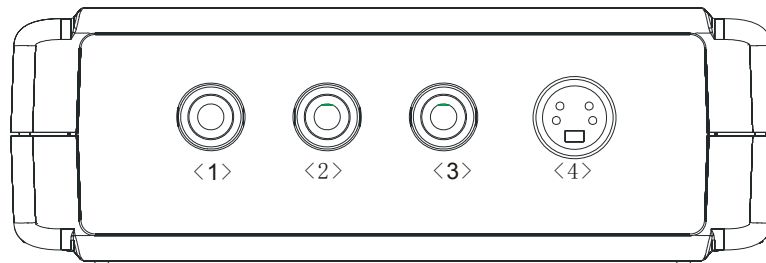

No	Name	Function
<1>	Audio input port	Used for audio signal input
<2>	Audio input port	Used for audio signal input
<3>	Composite video input port	Used for composite signal video input
<4>	Separate video input port	Used for separate signal video input

### 4.2.4 ECG Module

The module is connected to the USB port of the main unit via a USB cable.

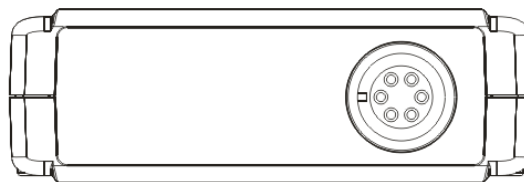

Name	Function
ECG lead port	Used for ECG signal input



## 4.3 Control Panel

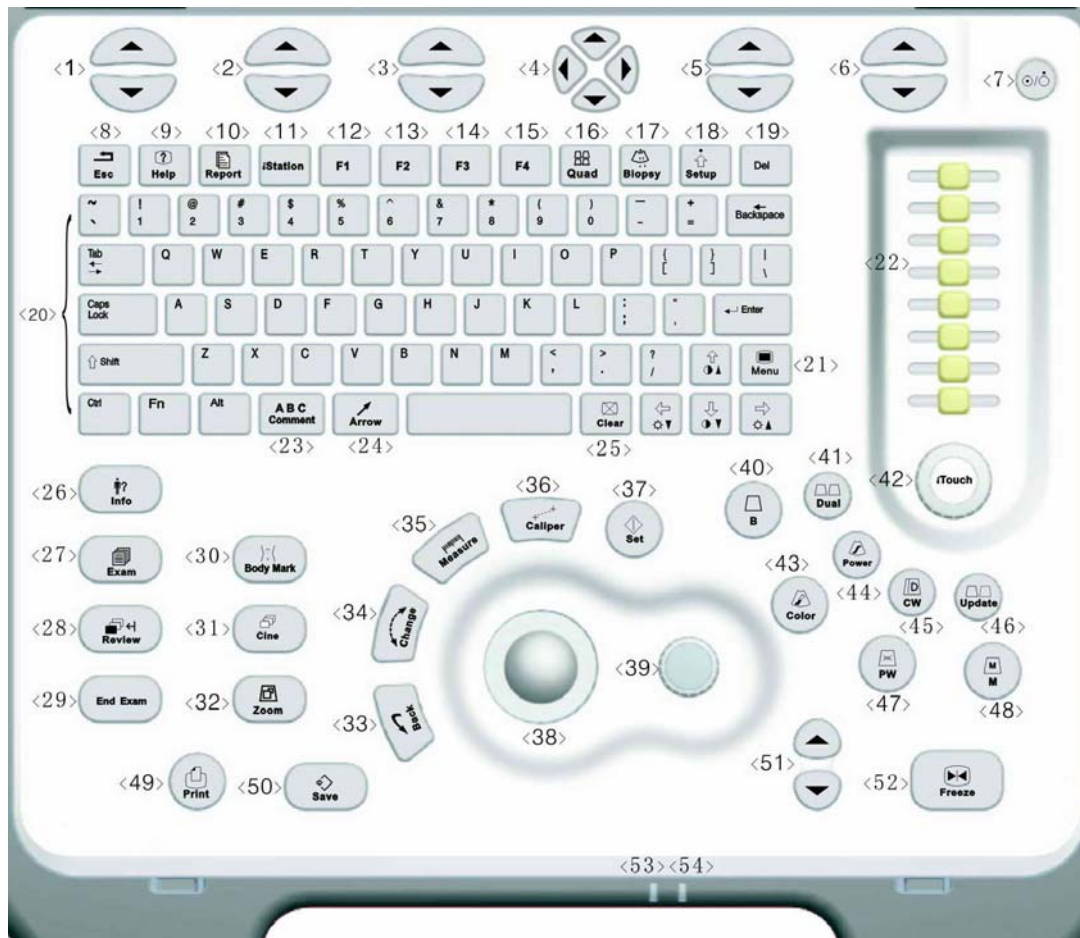

No	English Name	Name Description	Function
1	/	soft menu controls 1	Press to select the soft menu items displayed on the bottom of the screen. Refer to the subsequent contents for specific functions.
2	/	soft menu controls 2	Press to select the soft menu items displayed on the bottom of the screen. Refer to the subsequent contents for specific functions.
3	/	soft menu controls 3	Press to select the soft menu items displayed on the bottom of the screen. Refer to the subsequent contents for specific functions.

No	English Name	Name Description	Function
4	/	soft menu controls 4	Up / down controls are used to turn pages up / down when there are more-than-one pages for the soft menu;  Left / right controls are used to switch between the exam types.
5	/	soft menu controls 5	Press to select the soft menu items displayed on the bottom of the screen. Refer to the subsequent contents for specific functions.
6	/	soft menu controls 6	Press to select the soft menu items displayed on the bottom of the screen. Refer to the subsequent contents for specific functions.
7	/	Power button	When you press the power button to turn on the system, the system enters the work status and the indicator lights on and becomes green.  When you press the power button to turn off the system, the indicator lights off.
8	Esc	Escape	Press to exit the current status to the previous status.
9	Help	Help	Press to open or close the accompanying help documents.
10	Report	Report	Press to open or close the diagnosis reports.
11	iStation	/	Press to enter or exit the animal information management system.
12	F1	User-defined key	You can assign a function to the key.
13	F2	User-defined key	You can assign a function to the key.





No	English Name	Name Description	Function
14	F3	User-defined key	You can assign a function to the key.
15	F4	User-defined key	You can assign a function to the key.
16	Quad	4-split screen display	Press to enter or exit the 4-split screen display.
17	Biopsy	Biopsy	Press to show or hide the biopsy guide line.
18	Setup	Setup	Press to show or hide the Setup menu.
19	Del	Delete	Press to delete the comment, etc.
20	/	Alphanumeric keys	Same as those of PC.
21	Menu	Menu	Press to display or hide a mode-specific parameter menu.
22	TGC	Time Gain Compensation	Move to adjust time gain compensation.
23	Comment	Comment	Press to enter or exit the character comment status.
24	Arrow	Arrow	Press to enter or exit the arrow comment status.
25	Clear	Clear	Press to clear the comments or measurement calipers on the screen.
26	Info	Animal information	Press to enter the [Animal Info] screen.
27	Exam	Exam type	Press to switch between exam types.
28	Review	Review	Press to review the image files stored.
29	End Exam	End exam	Press to end an exam.
30	Body Mark	Body mark	Press to enter or exit the Body Mark status.

No	English Name	Name Description	Function
31	Cine	Cine review	Press to enter or exit the Cine Review status.
32	Zoom	Zoom	Press to enter or exit the Zoom status.
33	Back	Return or delete	Press to return to the previous operation or delete the previous item.
34	Change	Change	Press to toggle between calipers within the same measurement.
35	Measure	Measure	Press to enter or exit the application measurement mode.
36	Caliper	Caliper	Press to enter or exit the general measurement mode.
37	Set	Set	Press to confirm an operation, same as the left-button of the mouse.
38	/	Trackball	Roll the trackball to move the cursor position.
39	/	Multifunction knob	Rotate to adjust image parameters or comment arrows. Or when the cursor is hidden, press to show the cursor.
40	B	/	Press to enter the B mode
41	Dual	/	Press to enter the Dual mode from another mode; Press to switch between the two display windows in the Dual mode.
42	iTouch	/	Rotate to increase or decrease the image gain; press to optimize the image, serving as a one-key optimization.
43	Color	/	Press to enter the Color mode.
44	Power	/	Press to enter the Power mode.

No	English Name	Name Description	Function
45	CW	/	Press to enter the CW mode.
46	Update	/	<ul style="list-style-type: none"> <li>● Press to change the currently active window in B+M or PW mode.</li> <li>● Press to start or end image capture In Smart3D or iScape mode.</li> </ul>
47	PW	/	Press to enter the PW mode.
48	M	/	Press to enter the M mode.
49	Print	Print	Press to print; user-defined key.
50	Save	Save	Press to save; user-defined key.
51	Depth	Depth	Press to increase or decrease the imaging depth.
52	Freeze	Freeze	Press to freeze or unfreeze onscreen image.
53	/	Indicator 1	<p>Indicates if the main unit is connected to the power supply.</p> <p>When the main unit is not connected to the power supply, the indicator light is off.</p> <p>When the main unit is connected to the power supply, the indicator light is on and in green color.</p>

















No	English Name	Name Description	Function
54	/	Indicator 2	<p>Indicates the current status of the batteries.</p> <p>When the system is supplied with power by the batteries and the power capacity is lower than 30%, the indicator is yellow and flashes.</p> <p>When the batteries are being charged, the indicator light is on and in yellow color.</p> <p>When the battery capacity is charged to the full capacity, the indicator color changes from yellow to green.</p> <p>In other statuses, the indicator light is off.</p>







There are five keys which can work with the Fn key:

Key Name	Function
[Fn] + 	Press the two keys to increase the brightness of the LCD display.
[Fn] + 	Press the two keys to decrease the brightness of the LCD display.
[Fn] + 	Press the two keys to increase display contrast.
[Fn] + 	Press the two keys to decrease display contrast.

## 4.4 Symbols

This system uses the symbols listed in the following table, and their meanings are explained as well. Refer to “Safety Precautions” for safety symbols.

Symbol	Meaning
	Type-BF device
	Caution
	No user serviceable parts (applied to the power adapter)
	Indoor, dry location use only (applied to the power adapter)
	Power button
	Transducer port
	Network port
	Parallel port
IOIOI	Serial port
	S-VIDEO signal interface; VIDEO signal interface
	VGA signal; RGB signal
	IO extend port
	Remote control port
	USB port
	Audio signal
	Microphone input jack
	Battery status indicator
	Battery installation position indicator

Symbol	Meaning
	Port (reserved for future use)
	Product serial number
	Manufacture date
	Manufacturer
	Authorized representative in the European Community
	The device is fully in conformance with the low voltage directive 73/23/EEC and the EMC directive 2004/108/EC.  NOTE: The product complies with the Council Directive 2011/65/EU.



# 5 Set-up & Connections

---

## 5.1 System Set-up

Please read and understand the safety precautions before placing the system.

- 1 Turn off the power and disconnect the system from all peripherals.
- 2 Carry the system by holding the handle.
- 3 Place the system in a desired location.
- 4 Leave at least 20cm at the back and both sides of the system.

 <b>CAUTION:</b>	<b>Maintain a generous – free air flowing space around the back and both sides of the system; failure may result due to increased rise in system operating temperature.</b>
---	---

## 5.2 Power Supply

This system can work normally only when it is connected to the external power supply or the battery capacity is sufficient.

### 5.2.1 Connecting the External Power Supply

- 1 Connect the connector of the power adapter to the adapter port in the system.
- 2 Use a three-wire cable to connect the adapter with the external power supply.
- 3 The external power supply system must meet the following requirements:
  - 100 to 240V~
  - 50 / 60Hz
  - 1.5 - 0.6A
- 4 The model of the power adapter: ADP1210-01.

If you have any question about the power adapter, please contact your sales representative.

<b>NOTE:</b>	<b>1. You must use the specified power adapter.</b>
	<b>2. Do not use this power adapter in the conditions other than those specified.</b>

## 5.2.2 Powered by Batteries

- When connected to the external power supply, the system is powered by the external power. The lithium ion batteries inside it are in the charging status.
- When disconnected from the external power supply, the system is powered by the lithium ion batteries. Refer to “Chapter 21 Batteries” for the detailed operations and precautions.

## 5.3 Connecting / Disconnecting a Transducer

<b>⚠ CAUTION:</b>	1	Press [Freeze] to freeze an image or turn off the power of the system before connecting / disconnecting the transducer. Otherwise, system failure may occur.
	2	When connecting or disconnecting a transducer, place it in a proper position, to prevent the transducer from falling off or becoming damaged.
	3	Only use the transducers provided by Mindray. Aftermarket transducers may result in system or transducer damage or cause a fire.

### 5.3.1 Connect a Transducer

<b>⚠ WARNING:</b>	The transducers, cables and connectors are in proper operating order and free from surface defects, cracks and peeling. Using a defective transducer may cause electric shock.
-------------------	--

#### To connect a transducer:

- 1 Keep the cable end of the transducer to the right side of the system, and insert the connector into the port of the system, and then press it in fully.  
Note: Do keep the cable end of the transducer to the right-hand side so that you can connect it to the system correctly.
- 2 Toggle the lock lever to the top position. See the figure below.

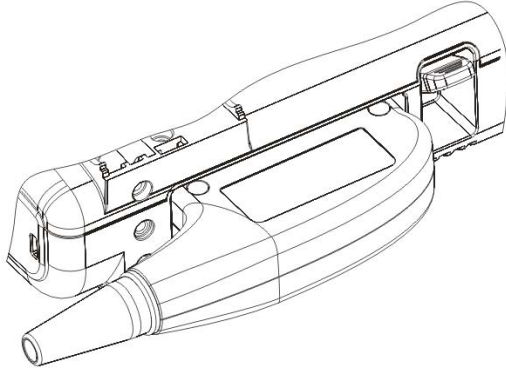

### 5.3.2 Disconnect a Transducer

To disconnect a transducer:

- 1 Toggle the lock lever to the bottom position to unlock the connector of the transducer.
- 2 Pull the transducer connector straight out, as shown in the figure below.

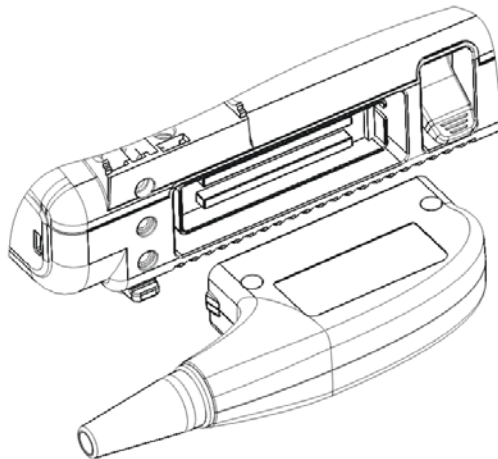

## 5.4 Connecting the Probe Extend Module

Connect the probe extend module to the main unit via the transducer port, thus the transducer port is extended to two usable ports and one docking port. See the following figure.

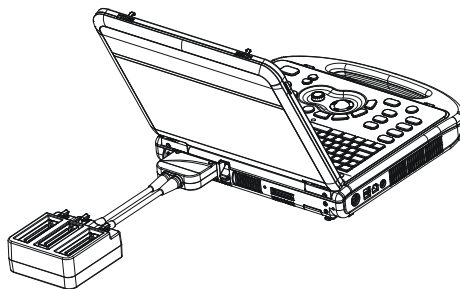

To connect the probe extend module:

- 1 Turn off the ultrasound system.
- 2 Align the connector with the probe port and carefully push into place with the bulge facing to the right side of the system (when you are facing to the front of the system.).
- 3 Toggle the lock lever to the top position.

**⚠ CAUTION:** You must press the power button to turn off the system before connecting or disconnecting the probe extend module. Otherwise the system may be damaged.

**NOTE:** If you use the probe extend module to connect a transducer, the image quality may be degraded.

## 5.5 Connecting IO Extend Module

Connect the IO extend module to the main unit via the IO extend port, thus the data port is extended to more than one. See the following figure.

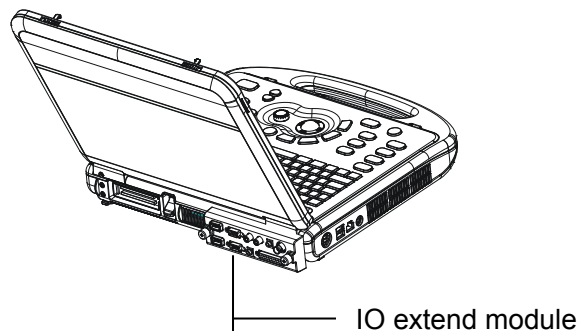

## 5.6 Connecting the V/A Extend Module

Connect the V/A extend port module to the main unit via a USB port. See the following figure.

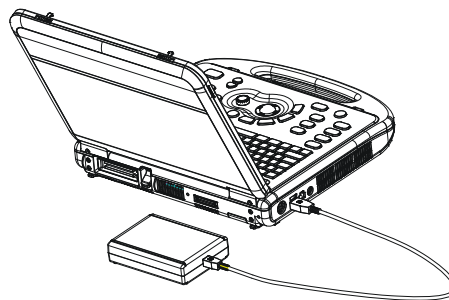

## 5.7 Connecting the ECG Module

Connect the ECG module to the main unit via a USB port. See the following figure.

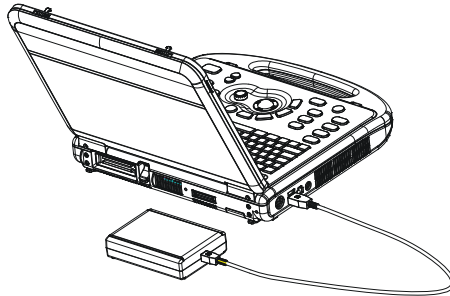

## 5.8 Connecting the Footswitch

Connect the footswitch to the main unit via a USB port. See the following figure.



You can set the functions of the footswitch in the Key Config page. Refer to the section 17.2 for footswitch setup.

## 5.9 Connecting / Removing a USB Memory Device

**⚠ WARNING:** DO NOT directly remove a USB memory device; otherwise the USB memory device and / or the system may be damaged.

When connecting a USB memory device to the ultrasound system via a USB port,

- 1 You can hear a sound if it is connected successfully.
- 2 You can see the symbol  in the lower right corner of the imaging screen.

**To remove the USB memory device:**

- 1 Click  to open the [Remove USB Device] screen.



- 2 Select the memory device to be removed.
- 3 Click [OK] and you can hear a sound.
- 4 Remove the USB memory device.

## 5.10 Installing a Graph / Text Printer

As shown in the figure below, a graph / text printer has a power cord and data cable. The power cord shall be directly connected to a wall receptacle as required.

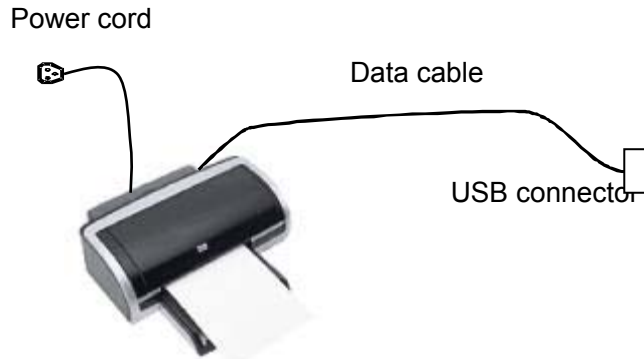
**To install the printer:**

- 1 Connect the data cable to a USB port of the system.
- 2 Connect the power cord of the printer to a wall receptacle.
- 3 Turn on the power of the ultrasound system and the power of the printer.
- 4 Press [Setup] key on the control panel to show the [Setup] menu.
- 5 Click [Peripheral Preset] to open the [Peripheral Config] screen.
- 6 The [Printer] page is opened by default.

- 7 Click [Add Printer] button to open the [Browse] screen.
- 8 Select the specific path for installation and click [OK] to install it.

**NOTE:** When you install the printer's driver, you must specify the specific path for installation; otherwise vague path may result in longer time for searching.

**To set up the printer:**

- 1 Click to select the installed printer in the list in the [Printer] page.
- 2 Set it as default printer.
- 3 To view its attribute, click [Printer Attribute] button to open the [Local Printer Attribute] screen.
- 4 To set paper size, select A4, B5, Letter and Unknown in the drop-down list.
- 5 To set print orientation, select between [Landscape] and [Portrait].
- 6 Click [OK] button.

## 5.11 Installing a Video Printer

The video printers supported by the system include analog video printers and digital video printers. The video printers, whether analog or digital, consist of B / W printers and color printers.

- To connect an analog video printer (SONY UP-897MD for example), the procedure is as follows (the methods for B / W printers and color printers are the same):
  - 1 Unpack the printer.
  - 2 Place the printer in the proper position.
  - 3 Connect the power cord of the printer to a receptacle.
  - 4 Use the IO extend module to provide the Video output port. Use the data cable provided with the printer to connect between the Video output port  and the **VIDEO IN** port of the printer. (If the MITSUBISHI CP-910E printer is used, the data cable is directly connected to the S-Video output port on the left side of the main unit).
  - 5 Load a paper roll, and turn on the system and printer.
  - 6 Press [Setup] key on the control panel to show the [Setup] menu.
  - 7 Click [Peripheral Preset] to open the [Peripheral Config] screen.

- 8 Click [I/O Config] tab to open the [I/O Config] page.
- 9 Set video input port, output size and output mode.
- 10 Click [OK] button.
  - To print the on-screen image, press the [PRINT] button on the printer's panel.
  - To use [Print] key on the control panel of the system, you
- 1 Use the Remote cable provided with the printer to connect between the remote port of the system's IO extend module and **REMOTE** port of the printer.
- 2 Press the [Setup] key to show the [Setup] menu.
- 3 Click [System] to open the [System] screen.
- 4 Click [Key Config] tab to open the [Key Config] page.
- 5 Click to select [Print] in the [Key] box on the left side.
- 6 Click to select [Analog B/W Video Print] in the [Output] box on the right side.
- 7 Click [OK] button to close the screen.
- 8 Click [Return] to make the settings to take effect.
- 9 Press the [Print] key on the control panel to print.

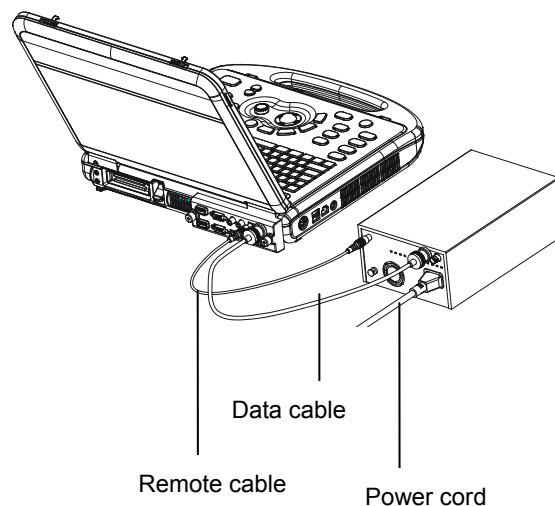

- To connect a digital video printer (MITSUBISHI P93DC for example):
  - 1 Unpack the printer.
  - 2 Place the printer in the proper position.
  - 3 Connect the power cord of the printer to a receptacle.



- 4 Use a USB cable to connect between the USB port of the system and the USB port of the printer.
  - 5 Load a paper roll, and turn on the system and printer.
  - 6 Press [Setup] key on the control panel to show the [Setup] menu.
  - 7 Click [Peripheral Preset] to open the [Peripheral Config] screen.
  - 8 Click [I/O Config] tab to open the [I/O Config] page.
  - 9 Set video input port, output size and output mode.
  - 10 Click [Printer] tab to open the [Printer] page.
  - 11 Click to select the printer in the list.
  - 12 Click [Set Digi B/W] button for black and white printer;  
Or [Set Digi Color] button for color printer.
  - 13 Press the [PRINT] key on the printer's panel to print.
- To use [Print] key on the control panel to print:
    - 1 Press the [Setup] key to show the Setup menu.
    - 2 Click [System] item to open the [System] screen.
    - 3 Click [Key Config] tab to open the [Key Config] page.
    - 4 Click to select [Print] in the [Key] box on the left side.
    - 5 Click to select [Digital B/W Video Print] for black and white printer;  
Or [Digital Color Video Print] in the [Output] box on the right side.
    - 6 Click [OK] button to close the screen.
    - 7 Click [Return] to make the settings to take effect.
    - 8 Press the [Print] key on the control panel to print.

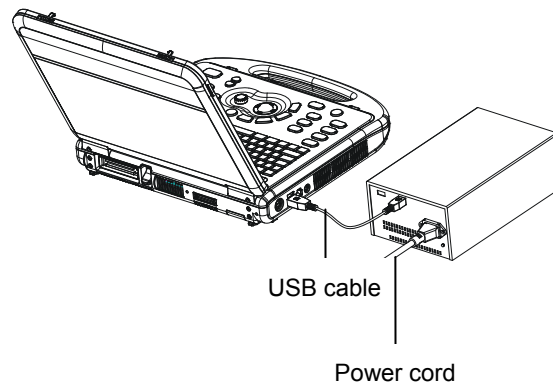

Please refer to the accompanying manuals of the printers for more details.

## 5.12 Use of M-Pack

### 5.12.1 Introduction of M-Pack

M-Pack is a portable pack, which is used when you carry it on your shoulders to hold the system and simultaneously operate the system.

- NOTE:**
- 1 You can use M-Pack inside or outside the room; however, if you want to place the system on a table to operate, you shall take the system out of the pack.
  - 2 Before using the M-Pack, you must carefully check all components of it; especially check that snap rings and slings are sturdy and free from being worn-out.
  - 3 Do not operate the system inside M-Pack for more than one hour; otherwise it may result in overheating.  
Before using the M-Pack, make sure that air vents of the system and M-Pack are not blocked.
  - 4 Be careful not to drop the system when you operate the system and move your footsteps at the same time.
  - 5 You must clean the transducer before placing it inside the pack in order to prevent it from staining the pack.

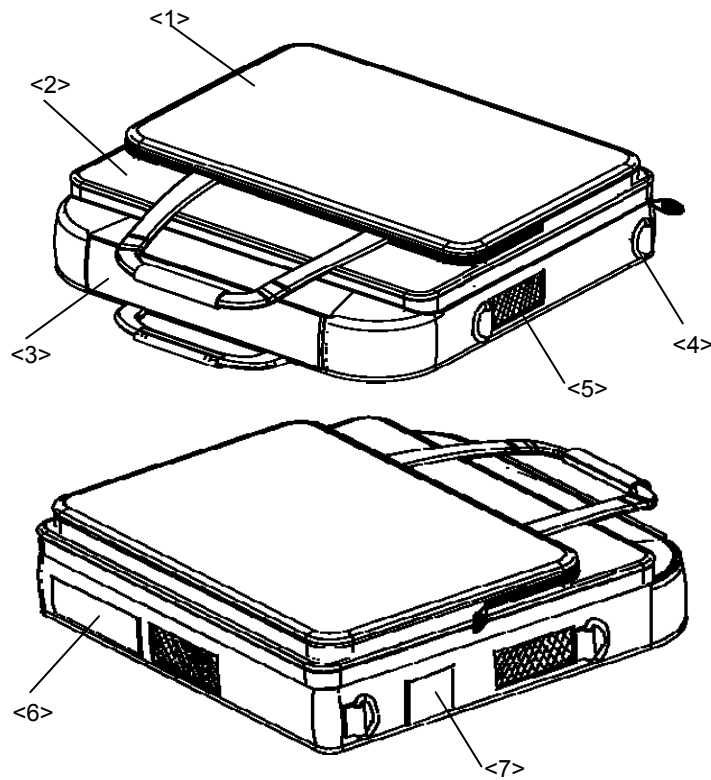

No	Name	Function
<1>	Accessory Bag	Holds transducer and ultrasound gel, etc.
<2>	Upper Cover	Holds and fixes the display of the system
<3>	Platform	Holds and fixes the control panel of the system.
<4>	Snap Ring	Connects the sling.
<5>	Air Vent	Used for ventilation and heat radiation.
<6>	Transducer Port Cover	Used for protecting the transducer port when the transducer is not connected to the system.
<7>	Port Cover	Used for protecting the port of the system.

### 5.12.2 Use of M-Pack

1. To place the system inside the M-Pack:
  - Place the handle and control panel in the platform of the pack;
  - Place the display of the system in the upper cover of the pack, and put the fixing belts beside the clips of the display to fix the display.

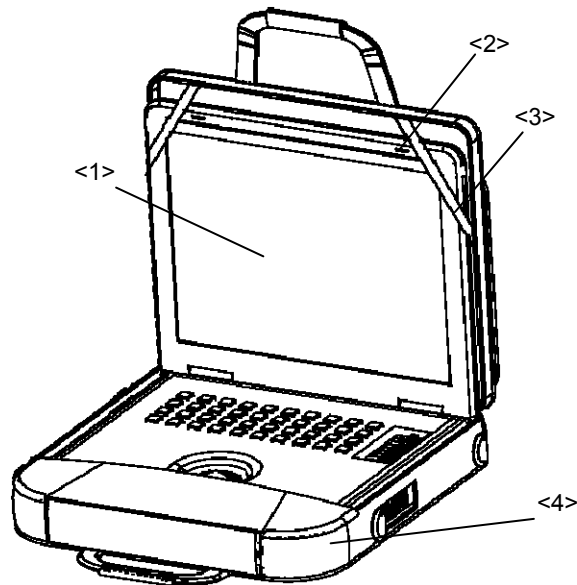

No	Name
<1>	Display
<2>	Clips of the display
<3>	Fixing belt
<4>	Platform

2. To fasten the M-Pack on the shoulders of the operator:
- Buckle up one end of one sling to the snap ring at the back of the platform, and buckle up the other sling as well.
  - Place the two slings over the shoulders and cross them at the back of the operator.
  - Hold the two ends of the slings to pass under the armpits and buckle up the two ends to the snap rings at the front of the platform.

**NOTE:** Make sure that the system is securely held before you finish buckling up the slings and the M-Pack is completely ready for operation, and guarantee that connections between components are sturdy, in order to prevent the system from being dropped and damaged.

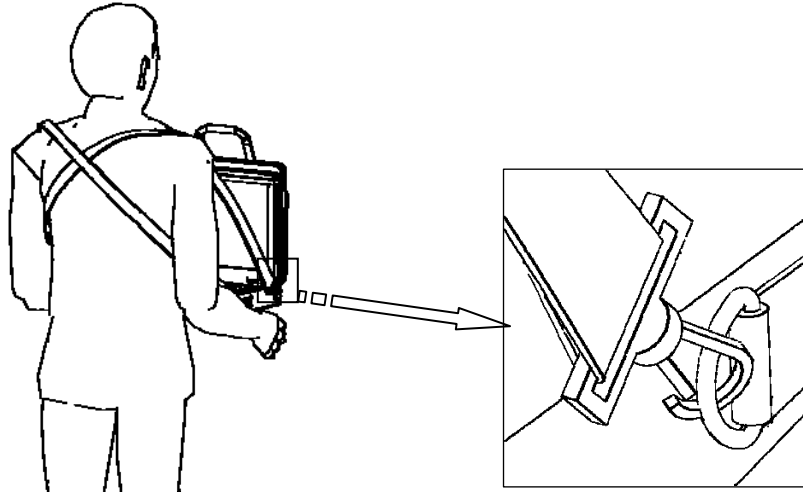

3. After removing the transducer port cover and connecting the transducer, you are ready for operating the system.

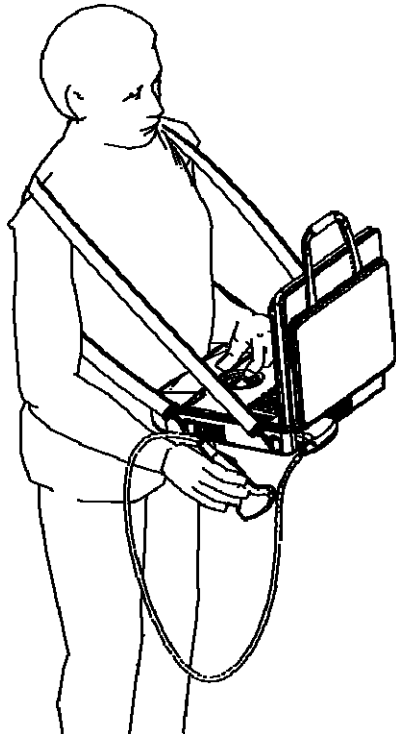

# 6 Power ON / OFF

---

## 6.1 Powering ON the System

**⚠ CAUTION:**

To ensure safe and effective system operation, you must perform daily maintenance and checks. If the system begins to function improperly – immediately stop scanning. If the system continues to function improperly – fully shut down the system and contact Mindray Customer Service Department or sales representative. If you use the system in a persistent improperly functioning state – you may harm the animal or damage the equipment.

● **Checking before Power ON**

To check the system before the system is turned on:

No	Check Item
1	The temperature, relative humidity and atmospheric pressure shall meet the requirements of operating conditions.
2	There shall be no condensation.
3	There shall be no distortion, damage or dirt on the system and peripheral devices. If any dirt is found, cleaning shall be performed as defined in section “22.1.1 Cleaning the System”.
4	There shall be loose screws on the monitor or control panel.
5	There shall be no cable damage (e.g. power cord). Maintaining secure connections to the system at all times.
6	The transducers and transducer cables shall be free of damage or stains. See the transducer operator’s manuals for transducer cleaning and disinfection.
7	No miscellaneous odds and ends are allowed to be attached or affixed to the control panel.
8	Check the power cord / power supply and all I / O ports. Ensure that all connections are free from damage and remain clear of foreign object blockages. There shall be no obstacles around the system and its air vent.
9	Prior to each use of a transducer, you should perform transducer cleaning and disinfection as per the transducer operator’s manual.
10	The overall scanning environment and field must be clean.

## ● Turning ON the Power

To turn on the system:

- 1 Press the power button  in the upper right corner on the control panel.
- 2 The system enters the work status.
- 3 The indicator lights on and becomes green.

To check the system after it is turned on:

No	Check Item
1	There shall no unusual sounds or smells indicating possible overheating.
2	There shall be no persistently displayed system error message.
3	There shall no evident excessive noise, discontinuous, absent or black artifacts in the B Mode image.
4	Check if there is abnormal heat on the surface of the transducer during an ultrasound procedure.
5	The control panel keys and knobs are fully functional.
6	The exam date and time are the same as the system date and time, and are displayed correctly.

<b>⚠ WARNING:</b>	1	<b>If you use a transducer giving off excessive heat, it may burn the animal.</b>
	2	<b>If you find anything not functioning properly, this may indicate that the system is defective. In this case, shut down the system immediately and contact Mindray Customer Service Department or sales representative.</b>

<b>NOTE:</b>	When you start the system or switch between transducers, you will hear clicking sounds – this is expected behavior.
--------------	---

## 6.2 Powering OFF the System

You need to follow the correct procedures to power off the system. In addition, after you upgrade the software or when the system is down, you need to power off and restart it.

### ● To power off your system:

- 1 Gently press the power button  once on the upper right corner of the control panel. The [System Exit] screen appears. See the figure below.

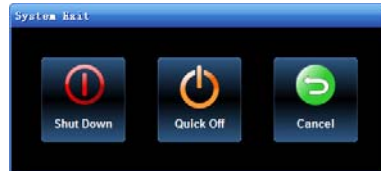

2



: To power off the system, click it. (It is recommended to select this button after the system software is upgraded.)



: To restart quickly, click it to power off the system quickly and then press the power button to restart quickly.



: To cancel the shutdown operation, click to cancel the shutdown operation and let the system return to the previous status.

- **If you will not use the system for a long period of time, you shall:**

- 1 Disconnect the power adapter;
- 2 Disconnect the mains power;
- 3 Turn off powers of all peripherals connected to the system.

- **To shut down the system in a direct way if you cannot do it normally:**

- 1 Only when you cannot shut down the system normally, you can directly shut it down. Press and hold the power button for a long time and the system will power off without displaying the [Shutdown Confirm] screen.
- 2 Shutting down the system this way may destroy the data.

<p><b>NOTE:</b></p> <ol style="list-style-type: none"> <li>1. DO NOT rush shutdown of the system in a direct way. It may destroy the data.</li> <li>2. After the software upgrade, please shut down the system in the normal way (using "Shut down" method) so as to guarantee a fully update.</li> </ol>
---



# 7 Basic Screen and Operation

---

## 7.1 Basic Screen

The system monitor displays ultrasound images, parameters, menus and measurement results window.

The following diagram maps out the different areas, such as information, image parameter & menu, image-in-image thumbnail, image area, thumbnail of images saved, body mark, help information & cursor icon, soft menu, and system status icon.

Manufacturer Logo	Hospital Name	Exam Date & Time	Acoustic Power & MI/TI			Freeze Icon
Animal Information			Probe	Exam Mode	Operator	ECG Icon
Image Parameter & Menu Area	Image Area					Thumbnail Area of Images Stored
Image-Image Thumbnail	Area of Help Information & System Status Icon					
Soft Menu Area					System Status Icon	

### 7.1.1 Information Area

The information area displays manufacturer logo, hospital name, exam date & time, acoustic power & MI/TI, freeze icon, animal information, transducer model, current exam type, operator's name or animal gender or animal age (can be set), ECG icon (if ECG module is connected), and accession #, etc.

To preset whether gender, age or operator is displayed:

- Press [Setup] key on the control panel to show the [Setup] menu.

- Click [System] item to open the [System] screen.
- Click [General] tab to open the [General] page.
- Check [Gender], [Age] or [Operator] in the [Animal Info] box in the upper left corner of the screen.

1 **Manufacturer logo** - The Mindray's logo is displayed in the upper left corner of the screen.

2 **Hospital name** - The name of your hospital is displayed on the screen, and can be entered through Setup → System → Region.

3 **Exam date & time** – refers to system date and time.

To set up the date, time and their formats:

- Press [Setup] key on the control panel to shown the [Setup] menu.
- Click [System] item to open the [System] screen.
- The [Region] page is opened by default.
- Select the [Time Format] and [Date Format].

Change [System Date] and [System Time].

4 **Acoustic power level & MI/TI index** - The acoustic power level and MI/TI indexes are displayed.

5 **Freeze icon** - The freeze icon is displayed after [Freeze] is pressed.

6 **Animal information** - The animal name & ID are displayed on the screen.

To enter the animal information:

- Press [Animal Info] key on the control panel to open the [Animal Info] screen.
- Enter the animal information in the fields and click [OK] button.

Or

- Press [iStation] key on the control panel to open the [iStation] screen.
- Click [import] to import animal information saved in the system.

Or

- Press [Animal Info] key on the control panel to open the [Animal Info] screen.
- Click [Worklist] button to open the [Worklist] screen.
- Query and import the animal information from the DICOM Worklist server.

7 **Transducer model** - The name of the currently active transducer is displayed on the screen.

8 **Current exam type** - The currently used exam type is displayed.

9 **Operator's name** - The operator's name is displayed on the screen. This information is entered through the animal information input screen.

10 **ECG icon** - The ECG icon consists of heart-shaped symbol and heart rhythm value.

11 **Accession #** - The accession # indicates exam number used in hospital information

system. It can be imported via DICOM or input manually.

## 7.1.2 Image Parameter and Menu Area

The image parameter and menu are both displayed in this area.

When no menu is available, this area displays the image parameters of the current mode.

When an image menu is displayed, the imaging parameters will be covered by the menu.

To show or hide the image menu, click [Menu] key on the control panel. If you click [Caliper] or [Measure] key to enter the measurement status, the menu shows automatically.

### Menu Area

The menu area consists of menu title, menu items and page-turning button.

- Menu title

The menu title refers to menu name. You can also navigate to other menus through the menu title

- page-turning button

When the menu items are too many to be displayed in one page, you can turn pages by clicking the page-turning button.

- menu items

What items appear in the menu is dependent upon image mode and preset.

To preset menu items displayed in the image menu and soft menu in each image mode:

- Press [Setup] key on the control panel to show the [Setup] menu.
- Click [Key and Menu Preset] item to open the [Key and Menu Preset] screen.
- The [Image Params] page is opened by default.
- Select items in [Available Items] box on the left side.  
Move the selected items to the [Menu] page for the image menu on the right side.
- Click [OK] button.

## 7.1.3 Image-in-Image Thumbnail

In the zoom status, this area displays the thumbnail of a complete image, and a rectangular frame is used to highlight the currently magnified area. This feature is called image-in-image.

## 7.1.4 Image Area

The image area displays the ultrasound images, ECG waveforms, grayscale bar, color bar, window-activating mark, coordinate axis, comments, measurement calipers, and body marks (pictograms).

## 7.1.5 Thumbnail Area of Images Saved

This area displays the thumbnails of saved images for the current animal.

## 7.1.6 Body Mark Area

In the body mark status, this area displays the available body marks.

## 7.1.7 Area of Help Information and Cursor Icon

The help information area displays various help information or progress bar in the current status.

The status icon area indicates the current cursor status.

## 7.1.8 Soft Menu Area

The soft menu items displayed are related to image mode and preset.

**To preset menu items displayed in soft menu in each image mode:**

- Press [Setup] key on the control panel to show the [Setup] menu.
- Click [Key and Menu Preset] item to open the [Key and Menu Preset] screen.
- The [Image Params] page is opened by default.
- Select items in [Available Items] box on the left side.
- Move the selected items to the [Softkey] page for the soft menu.
- Click [OK] button.

The soft menu area displays the functions respectively corresponding to the soft menu controls in the current mode. The menu items are operated through the soft menu controls on the control panel. The soft menu items vary depending on the preset in each image mode. The following is an example.

The soft menu controls are located at the top of the control panel, shown in the following figure (Taking the B mode menu as an example).

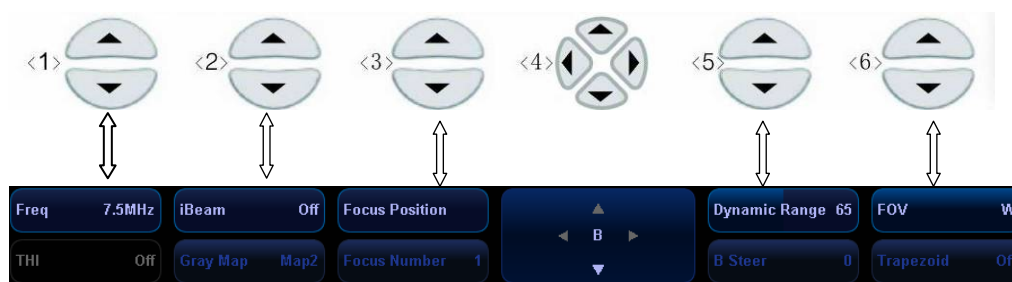

The up / down keys in <4> are used to turn pages up or down when the soft menu has multiple pages; the left / right keys in <4> are used to toggle between modes. You can operate the items only when they are highlighted.

The soft menu items vary depending on the menu. The menu navigation will cause the change of the menu, while the change of the menu will cause the menu navigation.

The soft menu items are operated respectively through the five groups of soft menu controls <1>, <2>, <3>, <5> and <6>. The soft menu items can also be adjusted by [Set] or [Back] on the control panel. Move the cursor onto a soft menu item and press [Set] or [Back] to change the parameter of the item.

When the current page of the soft menu is selected, all items are highlighted. After the page is turned to another, the previous page is darkened.

## **7.1.9 System Status Area**

This area displays the relevant system icons, such as USB memory device, printer, network, Chinese / English entry, and current system time, etc.

## **7.1.10 Measurement Result Window**

The measurement result window displays the results of recently performed measurements. You can move this area within the whole screen.

## 7.2 Basic Operations of Screens

The schematic of a screen is shown in the figure below. A screen consists of title, page tabs, content and buttons.

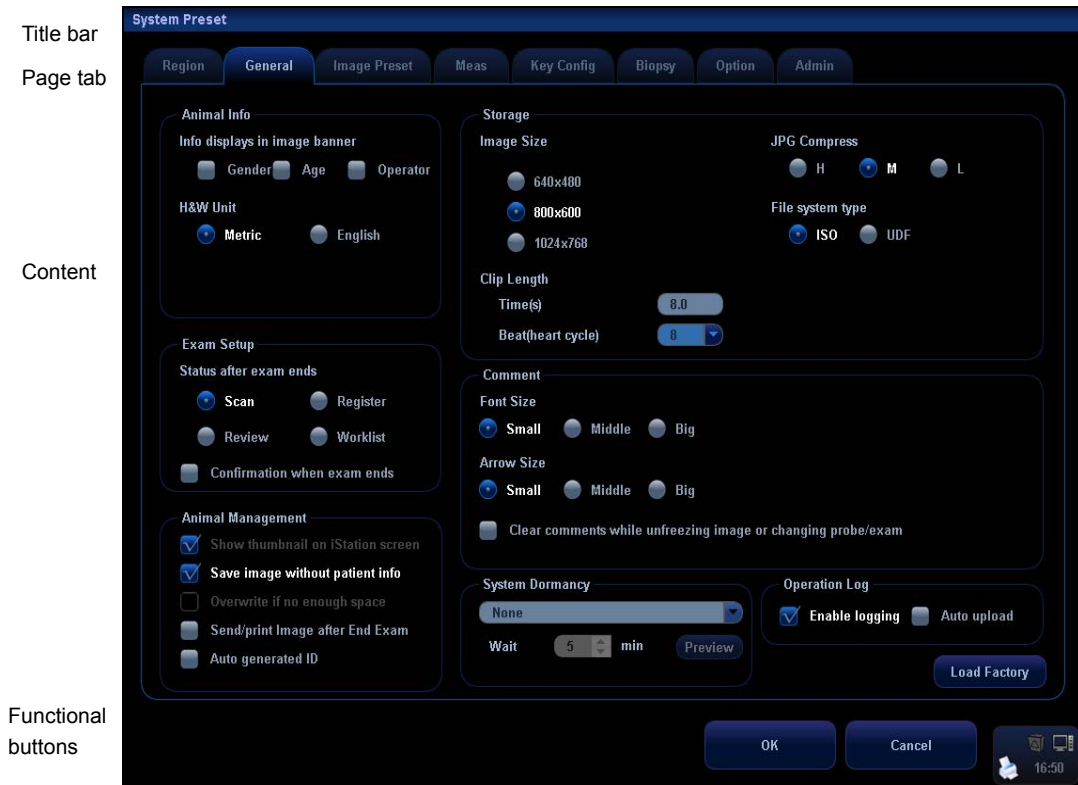

Composition	Description
Title Bar	The title bar is used to give a description for the content and function of the screen.
Page Tab	For some screens, contents are distributed across several pages. Use the selection pointer and [Set] key to open / close the available pages.
Content	<ul style="list-style-type: none"> <li>● Check box: click to check or uncheck the item.</li> <li>● Radio box: click to select the item.</li> <li>● Drop-down list: click [▼] to show the list and select an item.</li> <li>● Entry box: enter characters manually via the qwerty.</li> </ul>
[OK] and [Cancel]	When the operation of a screen is complete, press the [OK] or [Cancel] button to save or cancel the operation, and close the screen.

### ● Repositioning a Screen

#### To reposition a screen:

- 1 Roll the trackball to move the cursor onto the title bar of the screen. At this time the cursor becomes a  $\updownarrow$ ; press the [Set] key.
- 2 Roll the trackball and reposition the rectangular screen graphic to the new desired location.

- 3 Press the [Set] key, and the screen moves to the desired position.
- 4 After step 2, pressing the [Back] key will cancel the operation keeping the screen in the original position.

# 8 Animal Information

---

**⚠ CAUTION:** Before examining a new animal, press the [End Exam] key to end the exam of the previous animal, update the animal ID and information, to avoid mixing data of the next new animal.

## 8.1 To Start an Exam

You can start an exam in the following situations:

- New animal information: to start a new animal exam, you have to enter the animal information first, for details, please refer to “8.2.1 New Animal Information”; however, the system also supports anonymous animal exam, for details, please refer to “8.7 Anonymous Animal Exam”.
- New exam: to start a new exam for an already recorded animal, the recorded information can be obtained either through iStation or Worklist, refer to “8.2.2 Retrieve Animal Information from iStation” and “8.2.3 Retrieve Animal Information from Worklist” for details.
- Activate an exam: select an exam that is ended within 24 hours, and continue the exam with the imported animal information and exam data. For details, please refer to “8.5 Activate Exam” .
- Continue an exam: select an exam that is paused within 24 hours, and continue the exam with the imported animal information and exam data. For details, please refer to “8.3 Pause Exam & Continue Exam” .

General procedure for an exam: enter the animal information-> select an exam mode and probe -> choose an imaging mode -> start the exam.

To start a new animal exam, it is better to enter the detailed animal information. The system will set up a unique information database for each animal based on the animal information entered, so that the information of one animal will not be confused with that of another animal.

## 8.2 Animal Information

### 8.2.1 New Animal Information

- To enter the "Animal Info" screen:
  1. Press the <Info> key to open the Animal Info screen.
  2. Move the cursor onto the animal information area on the monitor and press <Set> to open the screen.



- To exit the "Animal Info" screen:
  1. In the [Animal Info] screen, click [OK] or press <Info> key to save the entered animal information and exit the screen.
  2. Click [Cancel] or press <Esc> to exit the screen without saving any of the entered animal data.
  3. After animal information is entered, press <Exam> to exit from animal information screen and enter probe selection screen.

To start a new animal exam, press <Info> key to open the [Animal Info] screen. See the figure below:

The screenshot shows the 'Animal Info' screen with the following sections and fields:

- 1. General Information:** Animal ID, Gender (Unknown), Animal (Dog), Last Name, First Name, M.I., DOB (2010/05/20), Age (0 Days), No., Host.
- 2. Study Description:** ABD, OB, GYN, CARD, VAS (selected), URO, SMP, PED. Fields include Study Description, Primary Indications, Secondary Indications, CPT4 Code, CPT4 Description, BP(R) / mmHg, BP(L) / mmHg.
- 3. Accession #, Ref. Physician, Comment:** Accession #, Diagnostician, Operator (Emergency), Ref. Physician, and a large text area for Comment.
- 4. Bottom Buttons:** New Animal, New Exam, Pause Exam, Cancel Exam, OK, Cancel, and a system tray with a clock showing 11:56.

To input animal information:

Open the [Animal Info] screen. Place the cursor into the specific box, the field box is highlighted and a flashing cursor appears where you can enter or select information from the options.

You can also change the cursor position by <Tab>, <Enter> or up/down controls

Information includes:

#### 1. General information

##### ■ Animal ID

Once you enter the ID and confirm it, you are not allowed to change it. There are 2 ways to generate the animal ID. “\” is not permitted.

##### ➤ Auto generated ID

Select “Auto generated ID” through the path: <Setup>→[Setup]→[System Preset]→[General]. The system will automatically generate the animal ID, and the generated ID can be edited manually.

➤ Enter the ID

If you deselect "Auto Generated ID", you need to enter an ID.

If an ID that is already existed in the system is entered, the system prompts "The ID existed, load data", you can choose to import the data;

■ Gender

Select Male, Female or Unknown for animal gender from the drop-down list.

■ Animal

Select Dog, Cat, Equine, Bovine, Ovine or Other for animal type from the drop-down list. Like ID, you are not allowed to change the animal type once you selected.

■ Name

Enter the animal name directly through the keyboard. Characters of A through Z and 0 through 9 and "." are allowed.

■ DOB and Age

You can enter the birth date of an animal, and the system will automatically calculate the age and display it on the screen. You can select the age unit among "Years", "Months" or "Days". If the age is less than one year, the system will automatically calculate the age in months or days. You can either enter the birth date of an animal manually according to the format displayed in the field, or click  to select the desired year, month and day and then click OK. In the table, you can select the desired year (or enter it manually); month and day, then click [OK] to finish it.

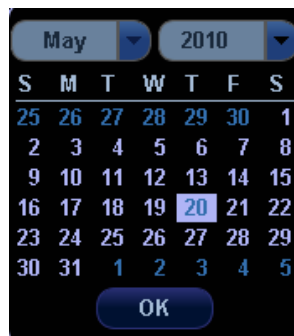

Note: When you enter the date manually, please enter it in the format as that of the system.

■ No.

Enter the animal No. manually.

■ Host

You can enter the name of the host or institution.

## 2. Exam Types

■ Exam Application Type:

You can select among 8 exam types: ABD (Abdomen), OB (Obstetrics), GYN (Gynecology), CARD (Cardiac), VAS (Vascular), URO (Urology), SMP (Small Part), and PED (Pediatrics).

Select the exam type tab to enter the exam-specific information.

- General information:

- Study description:** to input description for each exam.
- Primary indications:** to input the primary indications (reason to perform the exam.)
- Secondary indications:** to input the secondary indications.
- CPT4 code:** to input the CPT4 code.
- CPT4 description:** to input the CPT4 description.

- Exam specified information:

- ABD (Abdomen):

- (1) input height and weight.
- (2) BSA (Body surface area): after the height and weight are inputted, the system will automatically calculate the body surface area based on the formula which is set in the setup.

- OB (Obstetrics):

- (1) Calculate gestation age (GA) and estimated delivery date (EDD) based on last menstrual period (LMP), in vitro fertilization (IVF), basic body temperature (BBT), previous exam date (PRV). Select LMP, IVF, PRV, BBT, or EDD from the drop-down list.
  - LMP: After you enter LMP, the system will calculate and display GA and EDD.
  - IVF: After you enter IVF, the system will calculate GA and EDD.
  - BBT: After you enter BBT, the system will calculate GA and EDD.
  - PRV: After you enter previous exam date and GA (obtained for the previous exam), the system will calculate GA and EDD.
  - EDD: After you enter EDD, the system will calculate and display GA and LMP.
- (2) Gravida: times of pregnancy.
- (3) Ectopic: times of abnormal pregnancy (e.g. extrauterine pregnancy)
- (4) Gestations: number of embryo (1, 2, 3; 1 is default)
- (5) Para: times of delivery
- (6) Aborta: times of abortion

- GYN - (Gynecology)

- (1) LMP: input last menstrual period
- (2) Gravida: times of pregnancy.
- (3) Ectopic: times of abnormal pregnancy (e.g. extrauterine pregnancy)
- (4) Para: times of delivery
- (5) Aborta: times of abortion

- CAR (Cardiology):

- (1) input height and weight.
- (2) BSA (Body surface area): after the height and weight are inputted, the system will automatically calculate the body surface area based on the formula which is set in the setup.
- (3) BP & HR:

(4) RA Press (Right Atrium Pressure)

VAS – (Vascular):

(1) BP (L) & BP (R): input the blood pressure values of left arm and right arm.

URO – (Urology)

(1) Serum PSA: input serum PSA.

(2) PPSA Coefficient.

SMP – (Small parts)

PED - (Pediatrics)

### 3. Operating Information

- Accession #: refers to exam number used in hospital information system (DICOM).
- Operator, Diagnostician & Ref. Physician: input names of Operator, Diagnostician & Ref. Physician. If a name has been inputted before, you can select it from the drop-down list.
- Comment: exam-specific explanation or remarks.

### 4. Function buttons

- [New Animal]: click to clear the current animal information in the animal information screen in order to input new animal information.
- [New Exam]: click to clear the current exam information in order to create a new exam for the current animal.
- [Pause Exam]: to pause the current exam.
- [Cancel Exam]: to cancel the current exam.
- [Worklist]: to open the Worklist dialogue box. If you install DICOM package and set the Worklist server, click to open the Worklist screen to import the animal information from the server.
- [iStation]: to enter animal data management screen. You can search animals or manage the animal data stored in the system.
- Click [Basic] or [Detail] on the screen to show or hide the detailed animal information.
- [OK]: click to save the animal data entered and exit the screen.
- [Cancel]: click to cancel the animal data entered and exit the screen.

## 8.2.2 Retrieve Animal Information from iStation

Before searching an animal, the animal information shall be available in the ultrasound system or USB memory device. You need to enter the [iStation] screen to search the animal.

### To enter the iStation:

1. Press the <iStation> key on the control panel; or
2. Click the [iStation] button in the [Animal Info] screen.
3. Press the <Review> key on the control panel and click the [iStation] button in the screen; or



To search the animal information:

1. Select the data source of animal database, i.e. find where the system stores the animal data by default.
2. Input the searching condition:

Item: including Name, ID, BOD and Exam Date; then enter a keyword in accordance with the Item selected.

- Select “Find in results” , the system will search the keyword based on the existed searched results.
  - Click [Reset], the system will clear the information you entered, and all the recorded information of the system will be listed out.
3. Select the desired animal information in the list.
    - [New Exam]: to create a new exam for the selected animal. Click to enter [Animal Info] screen, meanwhile, the corresponding animal information is also imported to the new exam. After you edit the animal information in the [Animal Info] screen, select [OK] to start a new exam.
    - [Activate Exam]: click to continue an exam that has been finished within 24 hours.
    - [Continue Exam]: click to continue an exam that has been paused within 24 hours.
    - [Review]: click to switch to the Review screen.
    - [Exit]: click to exit iStation.

### 8.2.3 Retrieve Animal Information from Worklist

Install the DICOM package and set the Worklist server, connect the DICOM Worklist server and verify the connection. Click  in the Animal Info screen to open the

Worklist screen. Query and import animal information from the DICOM Worklist server. See the Worklist screen below:

To search the animal information:

1. Select the Worklist Server for the data source.
2. Input the searching condition:
  - Select exam date period, click [Query] to search the animal data in the period.
  - Enter animal ID, animal name, accession #, the system provides the result in real-time.
  - Or select the keyword type, enter the keywords and then click [Query] to search.
  - To reset the criteria, click [Clear] button.
3. Select the desired animal information in the list.
  - Click [Start Exam], the animal information is imported into the system and then an exam is started.
  - Click [Transfer], the animal information is imported into the [Animal Info] screen and it is opened. After you edit the animal information in the [Animal Info] screen, select [OK] to start a new exam.
  - Click [Show Detail] to see details of animal data.
4. Click [Exit] to exit the Worklist screen.

## 8.3 Pause Exam & Continue Exam

### 8.3.1 Pause Exam

1. Sometimes, you have to stop an uncompleted exam due to some special causes. When the exam is paused, the system can begin other exams.

Procedures:

- 1) Press the <Info> key to open the Animal Info screen.
  - 2) Click [Pause Exam].
2. If the system is powered off during scanning, the exam status turns "paused" after the system restart.

When an exam is paused, the system will do the followings:

- Saves the exam-related images, reports and measurement data, modifies the status as "Paused".
- Save the exam information, including report, imaging mode, exam mode, image parameters, operation mode, imaging / measurement data and so on.

### 8.3.2 Continue Exam

Select an exam that is paused within 24 hours, click [Continue Exam] in "iStation" or "Review" screen to continue the exam.

If you want to select an animal data in an external memory database, you have to first allow the system to load the animal data to the system's animal database.

Specific operation:

1. Enter the iStation screen.
2. Select items to be recovered in the list.
3. Click [Continue Exam] and restore the exam.

## 8.4 End Exam

Before examining a new animal, press <End Exam> to end the exam of the previous animal and update the animal ID and information, to avoid mixing data of the next new animal.

To end an exam, you can do one of the following:

- Press <End Exam> on the control panel.
- Click [New Animal] on the [Animal Info] screen to end the last animal exam and clear the animal information.
- Click [New Exam] on the [Animal Info] screen (or iStation screen, or Review screen) to end the last exam and clear the exam data.

## 8.5 Activate exam

The exam that is ended within 24 hours can be activated.

Specific operation:

1. Enter iStation or Review.
2. Select items to be activated in the list.
3. Click [Activate Exam] and restore the exam.

Tips:

- The system can automatically load the animal information and exam data to continue the exam.
- If you want to select an animal data in an external memory database, you have to first allow the system to load the animal data to the system's animal database.

## 8.6 Cancel an exam

An undergoing exam can be stopped by clicking [Cancel Exam] in the [Animal Info] screen.

1. Press the <Info> key to open the [Animal Info] screen.
2. Click [Cancel Exam].
3. The system prompts the confirmation message, and requires selecting the reason for canceling the exam.
4. Select the reason and click OK.
5. After the above operations being taken, the exam is cancelled, and the images, measurements and report are saved with the status of the exam to be "Canceled".

## 8.7 Anonymous Animal Exam

The system can also carry out image scanning and measurement even though no animal information is available.

- Deselect "Save image without animal info" in "<Setup>→[Setup]→[System Preset]→[General]→Animal Management".

When saving an image, the system pops up the Animal Info screen to ask for the animal information.

- Enter the information and click OK to save the image and data.
- If cancel the current operation, the system will not respond to the command of saving image and ending exam.
- If "Save image without animal info" is selected  
The system will automatically generate an ID, and save the images in the ID.



# 9 Exam Types

---

**⚠ CAUTION:**

If the exam type is changed during a measurement, all measurement calipers on the image will be cleared. The data of general measurements will be lost, but the data of application measurements will be stored in the reports.

## 9.1 Introduction of Exam Types

The system can perform the following exam types:

- Abdomen
- Cardiac
- Gynecology
- Obstetrics
- Small Part
- Vascular
- IMT (Option)
- User-defined

## 9.2 Selecting Transducer and Exam Type

■ Selecting Probe & Exam Screen

- 1 Directly connect a transducer or connect a transducer via the Probe Extend Module.
- 2 Press <Exam> key on the control panel to open the Select Probe & Exam screen.
- 3 Roll the trackball to move the cursor onto an exam type in a transducer column, and press <Set>. The probe and the exam type are selected, and the selected exam type is entered.



Three ways to save the current image parameters in the exam mode:

- [Save]: Click [Save] button to save current image parameters as preset. A dialog box pops up to prompt you the operation will overwrite the current image parameters. You can select [OK] or [Cancel].



- Click [Save As] to save the current image parameters to be the preset data for the specified exam mode.
- You can also set user-defined key for saving image parameters as preset through the path: <Setup>→[Setup]→[System Preset]→[Key Config].

[Exam Preset]: Click to enter the exam preset screen.

[Exit]: Click to cancel the exam and probe selection and exit the screen.

## 9.3 Setting Exam Types

- 1 In the Setup menu, select the [Exam Preset] item to enter the exam preset screen.  
Or
- 2 Press the [Exam] key to open the Select Probe & Exam screen and click the [Exam Preset] button to enter the exam preset screen.





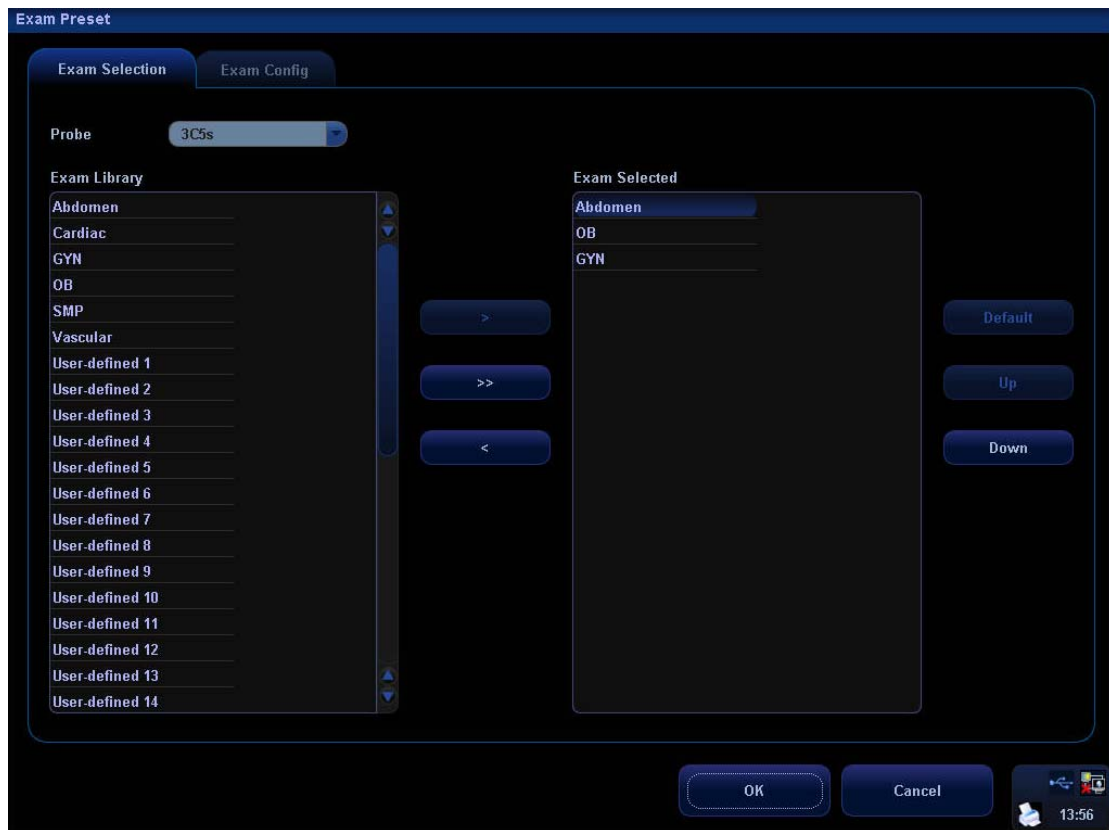

The exam preset screen consists of two tab sheets: Exam Selection and Exam Config.

## 9.3.1 Exam Selection

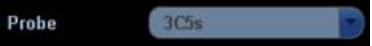
After the Exam Preset screen is entered, the screen will display the Exam Selection page, as shown in the figure below. This page is used to assign an exam type to a specific transducer.





The selection method is described as follows:

- 1 Select a transducer: move the cursor onto the column **Probe** , and select the transducer model through the drop-down menu.
- 2 On the right side of the screen, you can view the exam types supported by the current transducer. On the left side, you can view all the exam types supported by the system, i.e., Exam Library.
- 3 To delete an exam supported by the current transducer, select the exam first, and then click  to delete it.
- 4 To add an exam for the current transducer,
  - a) Select the exam from the Exam Library on the left and click  to add it to the Exam Selected.
  - b) Click  to add the exams, which Exam Library has but Exam Selected doesn't have, from Exam Library to Exam Selected.
- 5 After the selected exam types are set, you can arrange the order of these exams. Select the  and  buttons to adjust the order of these exam types one by one.
- 6 To set an exam type as a default exam type for a transducer:

a) first select the exam type,

b) then click .

7

Click  to confirm the modified setup; or click  to cancel the modified setup.

## 9.3.2 Exam Configuration

The Exam Config screen is shown as follows:



After an exam type is selected,

- 1 Click [Rename] to change the name of the user-defined exam type,
- 2 Click [Up] or [Down] to move the position of the exam mode.
- 3 Click [Copy] to copy the parameters of the selected exam type.
- 4 Select a second exam and, click [Paste] to paste the copied parameters to the secondly-selected exam type.
- 5 Click [Export] to open the screen to store the parameters of the selected exam types.
- 6 Click [Load] to open the screen to load the parameters of the exam type.
- 7 Click [Export All] to open the screen to store the parameters of all exam types for the current transducer.
- 8 In addition, you can preset measurements, comments, body marks and image parameters for the exam types.

### 9.3.3 User-defined Exam Types

To define exam types for a transducer:

- 1 Press [Setup] key on the control panel to show the [Setup] menu.
- 2 Click [Exam Preset] item to open the [Exam Preset] screen.
- 3 Click [Exam Config] tab to open [Exam Config] page.
- 4 Click to select [User-defined 1] in the [Exam Mode] area.
- 5 Click to select an exam region in the [Application] area.



- 6 Click [Rename] button to open the [Rename] screen.



- 7 Enter a new name.
- 8 Click [Measure Preset] to set measurement package and attributes.
- 9 Click [Comment Preset] to set comments.

- 10 Click [Body Mark Preset] to set body marks.
- 11 Click [Image Preset] to set images.
- 12 Click [OK] button to confirm.

# 10 Image Modes

---



- ⚠ WARNING:**
1. The images displayed in this system are only reference for diagnosis. Mindray is not responsible for the correctness of diagnostic results. It is the responsibility of the clinician, who performs the exam, to capture the correct diagnostic results.
  2. Color flow imaging is only reference, not for confirming a diagnosis. Please compare the images with that of other machines, or make diagnosis using none-ultrasound methods.







## 10.1 Image Modes

The system supports the following imaging modes:

- B Mode
- M Mode
- C Mode: Color, Power or DirPower
- D Mode: PW Doppler or CW Doppler

## 10.2 Switching Between Image Modes

Key	Select and Switch
	B Mode control: press to enter the B Mode
	M Mode control: press to enter the M Mode
	Pulsed Wave Doppler control: press to enter the PW Doppler mode

	Continuous Wave Doppler control: press to enter the CW Doppler mode
	Color Mode control: press to enter Color Mode
	Power Mode control: press to enter Power Mode
	Dual-split display key: press to enter the Dual-split display mode.
	Quad-split display key: press to enter the Quad-split display mode.
	Switching key: <ul style="list-style-type: none"> <li>● Press to change the currently active window in B+M or PW+B / PW+C mode.</li> <li>● Press to start or end image capture In Smart3D or iScape mode.</li> </ul>

## 10.3 Image Adjustments

Imaging adjustments are performed through the following methods:

1. Adjustments through image menus or soft menus
  - The image menus are located on the upper left corner of the screen.
 

To adjust:

    - 1) Press [Set] or [Back] key; or
    - 2) Rotate the [Multifunction] knob.
  - The soft menus are located at the bottom of the screen.
 

To adjust:



- 1) Press the soft menu controls; or
  - 2) Press [Set] or [Back] key;
  - 3) Press the soft menu controls 4 to page up / down.
- What items appear in the menu is dependent upon image mode and preset. So what you see in your system may be different from screens and menus exemplified in this manual.
  - You can preset the menu items for image menus or soft menus. Refer to [17.8 Key and Menu Preset] for details.

To preset menu items displayed in the image menu and soft menu in each image mode:

- 1) Press [Setup] key on the control panel to show the [Setup] menu.
  - 2) Click [Key and Menu Preset] item to open the [Key and Menu Preset] screen.
  - 3) The [Image Params] page is opened by default.
  - 4) Select items in [Available Items] box on the left side.
  - 5) Move the selected items to the [Menu] page for the image menu on the right side.
  - 6) Click [OK] button.
- The image menus and soft menus will be called “menu” in the subsequent image adjustment.
2. Adjustments in the image parameter area through the [Multifunction] knob

The image parameter area is located in the upper left corner of the screen. The image parameters are displayed while the image menu is not available. Roll the trackball to move the cursor onto a parameter,

- A frame appears around it;
- Press [Set] and the cursor disappears;

- Rotate the [Multifunction] knob to change the parameter;
  - Press [Set] again to confirm.
3. Adjustments through keys / [Multifunction] knob / sliders

Some parameters can be adjusted through keys / [Multifunction] knob / sliders on the control panel, e.g. depth, gain, and TGC, etc.



## 10.3.1 B Mode

### 1. Changing B image display

In B Mode, you can change the display depth, flip (horizontally or vertically) images, rotate images, change the view field or magnify images.

#### Depth

To change depth, press keys in the lower right corner of the control panel.

- Press  key to decrease the depth;
- Press  key to increase the depth.

The adjustable image depth is dependent upon the selected transducer.

#### Frequency

To select the current transducer frequency:

- Click [Freq] item in the menu to select among frequency values
- The transducer frequency is also displayed in the image parameter area in the upper left corner of the screen.

#### THI (Tissue Harmonic Imaging)

The THI feature is used to enhance penetration in the far field as well as resolution in the near field, and improve images of small parts.

- Click [THI] item in the menu to turn on or off the feature.

#### Acoustic Power

The acoustic power refers to ultrasound power transmitted from the transducer. You should perform exams according to actual situation and ALARA Principle.

- Click [A. Power] item in the menu to select among percentages.
- The AP value is also displayed at the top of the screen.

#### Trapezoid

To turn on / off Trapezoid, click [Trapezoid] item in the menu.

#### Flipping or rotating an image

- Left / Right Flip: Click [L/R Flip] item in the menu to select [Left] or [Right] to flip an image left or right.

- Up / Down Flip: Click [U/D Flip] item in the menu to select [Up] or [Down] to flip an image up or down.
- Rotation: Click [Rotation] item in the menu to rotate an image in increments of 90°.

When you flip or rotate an image, the “M” mark will change its position on the screen; the M mark is located in the upper left corner of the imaging area by default.

### **FOV (Field of View)**

To change field of view:

- Click [FOV] item in the menu;
- Select among four selections W, M1, M2, and N.

### **B Steer**

- The B Steer feature is valid only for linear transducers.
- Click [B Steer] item in the menu to select among B steer angles.

## **2. Optimizing B image**

You have the ability to optimize the animal examination through parameter changes.

### **iTouch**

The iTouch feature is used to optimize multiple B Mode imaging parameters. The [iTouch] key is located below the gain sliders on the right side of the control panel. Press [iTouch] key to obtain the one-key optimization.

To set the one-key optimization:

- Press [Setup] key on the control panel to show the [Setup] menu.
- Click [Image Preset] item to open the [Image Preset] screen.
- The B/THI page is opened by default.
- The [iTouch] item is displayed in the left box.
- Select among Dark, Gray, Bright, Brighter and Brightest.

Press and hold [iTouch] key to exit the one-key optimization.

### **Gain**

To adjust the overall B Mode image gain:

- Rotate the [iTouch] key located on the right side of the control panel.
- The gain value is displayed on the image parameter area, e.g. G70.

### **TGC**

Time Gain Compensation is used to adjust or compensate depth gain to different segments of the image. The system has 8-segment TGC sliders on the upper right side of the control panel.

- To increase the gain compensation at an area of interest, move the TGC slider to the right.
- To decrease the gain compensation at the corresponding area of interest, move the TGC slider to the left.

### **iBeam**

The iBeam feature is used to combine multiple frames with different steer angles into one frame.

- iBeam is valid only for linear transducers.
- Click [iBeam] in the menu select [On] or [Off] to turn on or off this feature.

### Focus Number and Focus Position

To make the beams closer in the region of interest:

- Increase the number of focal zones;
- Or move the position of the focal zones.
- The focus position symbol ◀ is displayed on the right side of the image.

To change focus number or focus position:

- Click [Focus Number] or [Focus Position] item in the menu.
- Change the number or position of focal zones.

### Dynamic Range

The Dynamic Range function is used to adjust contrast resolution of the B Mode image to compress or expand the gray display range.

- Click [Dynamic Range] item in the menu.
- Select a Dynamic Range value.
- The value is also displayed in the image parameter area, e.g. DR 70.

### Gray Map

The gray maps are obtained from the combinations of transform curve, gray rejection and  $\gamma$  correction.

- Click [Gray Map] item in the menu.
- Select among maps 1 through 8.
- You can set the gray map in the image preset.

### Line Density

- Click [Line Density] item in the menu.
- Select between Low and High.
- Note: Changing Line Density will change B Mode frame rate (higher line density / lower frame rate, lower line density / higher frame rate).

### IP (Image Processing)

Image Processing is a combination of image parameters, and the system has 8 IP preset combinations.

- Click [IP] item in the menu.
- Select among IP values.
- The IP value is also displayed on the image parameter area.
- You can set IP in the image preset, and the path is Setup → System → Image Preset → B/THI → B IP.

### Colorize and Colorize Map

- Click [Colorize] item in the menu to select [On] or [Off] to turn on / off the feature.
- Click [Colorize Map] item in the menu to select among various map schemes.
- Changing Map will also change the color bar.

### iClear

iClear is used to increase the B Mode image profile for greater boundary detail.

Click [iClear] item in the menu to change it.

### Persistence

Persistence is used to remove image noise and improve the overall image quality.

- Click [Persistence] item in the menu.
- Select between 0 and 7.

### **TSI (Tissue Specific Imaging)**

This feature is used to adjust the speed of sound against various tissue types, i.e., General, Muscle, Fluid and Fat.

- Press [Menu] key to show the B Mode menu.
- Click [TSI] item in the menu to select among four selections.

### **Noise Rejection**

- Click [Noise Reject] item in the B Mode menu.
- Select the value among 0, 1, 2 and 3. The smaller the value, the smaller the noise rejection; the greater the value, the greater the noise rejection.
- This feature rejects B Mode image noise, thus increasing signal-noise ratio.

### **Post Process**

Post processing is used to apply modifications to a gray map in order to optimize overall image quality.

- Select [Curve], [Rejection] or [ $\gamma$ ] from the B Mode menu.
- The post processing feature is valid for images in real time, freeze or cine review status.

### **Gray Transform**

- 1 From the B Mode menu, select [Curve] to pop up the gray transform curve.
- 2 Move the cursor onto a node “•” along the curve. The cursor becomes a .
- 3 Press the [Set] key, and roll the trackball to move the node along the vertical axis adjusting the gray map. You will notice the B Mode image changes at the same time showing the modification in real-time. You can select multiple nodes to create a unique gray map profile.
- 4 Press the [Set] key a second time to fix the node in the new position.
- 5 Repeat the above process to adjust multiple nodes.
- 6 Pressing the [Back] key will cancel the active adjustment, returning the node back to the previous position.
- 7 Press the [Set] key on the [Linear] selection, and the gray map will transform to become a 45° straight line.
- 8 Click [OK] to confirm the adjustment and exit the gray map toolbox.
- 9 Click [Cancel] to cancel all modification and resume the previous curve and exit the gray map toolbox.

The adjustment is shown in the following figures:

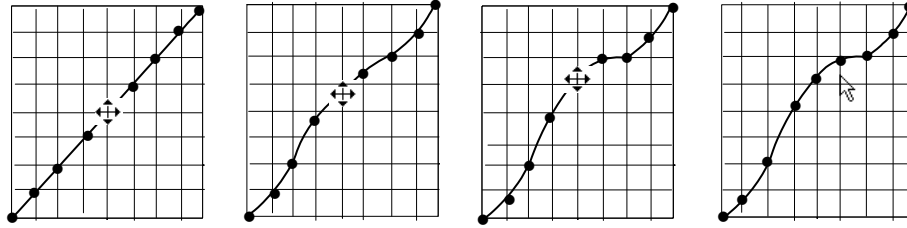

### Gray Rejection

The Gray Rejection feature processes and rejects gray scale levels within certain ranges.

- 1 Click the [Rejection] item in the B image menu or soft menu, and the Gray Rejection toolbox will appear.
- 2 Move the cursor onto the ▲ marker. The cursor becomes a ⊕. Press the [Set] key and roll the trackball to move the ▲ marker along the horizontal axis. You will notice the B Mode image changes at the same time showing the modifications in real-time.
- 3 After the adjustment is complete, press the [Set] key a second time to fix the marker in the new position.
- 4 Pressing the [Back] key will cancel the active adjustment, returning the node back to the previous position.
- 5 Click [OK] to confirm the adjustment and exit the gray map toolbox.
- 6 Click [Cancel] to cancel all modification and resume the previous curve and exit the gray map toolbox.

The adjustment is shown in the following figures:

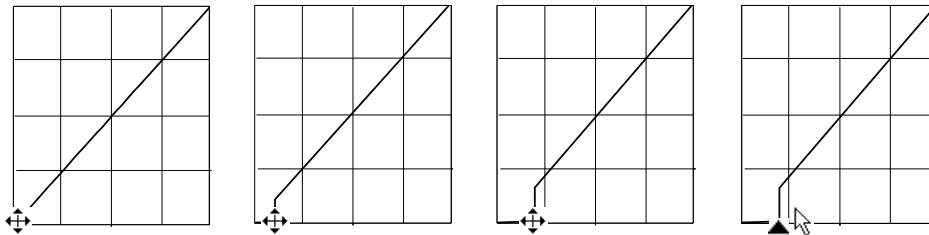

### γ Correction

- The  $\gamma$  correction is used to correct non-linear distortion of images.
- The  $\gamma$  correction selections are represented by 0, 1, 2, and 3, respectively representing coefficients of 1, 1.1, 1.2, and 1.3.
- Adjust the  $\gamma$  item in the B image menu or soft menu, and the  $\gamma$  correction parameters are displayed on this menu.

## 10.3.2 M Mode

### 1. Changing M image

#### Frequency

To select the current transducer frequency:

- Click [Freq] item in the menu to select among frequency values.
- The transducer frequency is also displayed in the image parameter area in the upper left corner of the screen.

#### Time Mark

To turn on or off time line markers in the M Mode, click [Time Mark] item in the menu to select [On] or [Off].

#### Speed

This function is used to increase or decrease the M Mode sweep speed.

- Click [Speed] item in the menu.
- Change the speed value. The smaller the value, the quicker the refresh speed; the greater the value, the slower the refresh speed.

#### Acoustic Power

The acoustic power refers to ultrasound power transmitted from the transducer. You should perform exams according to actual situation and ALARA Principle.



- Click [A. Power] item in the menu to select among percentages.
- The AP value is also displayed at the top of the screen.

#### Display Format

- Click [Disp Format] item in the menu.
- Select [Disp Format] for the B and M images among four display formats: L/R, V 1:1, V 1:2 and Full.

#### Depth

To change depth, press keys in the lower right corner of the control panel.

- Press  key to decrease the depth;
- Press  key to increase the depth.

### 2. Optimizing M images

#### Gain

To adjust the overall image gain:

- Rotate the [iTouch] key located on the right side of the control panel.
- The gain value is displayed on the image parameter area, e.g. G70.

#### Gray Map

The gray maps are obtained from the combinations of transform curve, gray rejection and y correction.

- Click [Gray Map] item in the menu.
- Select among maps 1 through 8.
- You can set the gray map in the image preset.

**Focus Position**

- Click [Focus Position] item in the menu.
- Change the position of focal zones.
- The focus position symbol ◀ is displayed on the right side of the image.

**Dynamic Range**

The Dynamic Range function is used to adjust contrast resolution of the B Mode image to compress or expand the gray display range.

- Click [Dynamic Range] item in the menu.
- Select a Dynamic Range value.
- The value is also displayed in the image parameter area, e.g. DR 70.

**IP (Image Processing)**

Image Processing is a combination of image parameters, and the system has 8 IP preset combinations.

- Click [IP] item in the menu.
- Select among IP values.
- The IP value is also displayed on the image parameter area.
- Set IP in the image, and the path is Setup → System → Image Preset → M → M IP.

**Colorize and Colorize Map**

- Click [Colorize] item in the menu to select [On] or [Off] to turn on / off the feature.
- Click [Colorize Map] item in the menu to select among various map schemes.
- Changing Map will also change the color bar.

**M Soften**

This feature is used to process the scan lines of M images to reject noise, making the image details to be clearer.

- Click [M Soften] item in the menu.
- Change the value. The smaller the value, the smaller the line correlation.

**Post Processing**

You can select [Curve], [Rejection] or [γ] from the M Mode menu. The adjusting methods for M images are the same as those for the B images.

### 10.3.3 Color Mode

Color Mode is used to detect blood flow information throughout the body. The system will display an onscreen color bar graphic indicating flow direction towards and away from the transducer. In addition, the system indicates blood flow velocity. According to the Color scale selection, increased / high flow will display brightly, low / slow flow will display darkly.

**1. Changing Color Mode Display****Frequency**

To select the current transducer frequency:

- Click [Freq] item in the menu to select among frequency values
- The transducer frequency is also displayed in the image parameter area in the upper left corner of the screen.

**RoI box position and size adjustment**

- Hide the Color image menu.



- When the Rol box is dotted line, you can roll the trackball to change its position. Press [Set] to fix it in the new position and the Rol box turns to solid line.
- Roll the trackball to change its size, and press [Set] to fix it in the size.

### **B/C Wide**

Set and constrain the maximum width of the B Mode image to that of the Color Rol.

- Click [B/C Wide] item in the menu.
- Select [On] or [Off] to turn on / off the feature.

### **Scale**

The Scale feature is used to adjust speed scale and change PRF.

- Click [Scale] item in the menu.
- Increase or decrease its value.

### **Baseline**

To adjust the Color Mode Baseline to change the range of flow speed:

- Click [Baseline] in the menu.
- Increase or decrease its value.

### **Dual Live**

Dual Live allows B mode and Color mode to be active at the same time.

- Click [Dual Live] item in the menu.
- Select [On] or [Off] for Dual Live to turn on or off B and Color alive at the same time.

### **Acoustic Power**

The acoustic power refers to ultrasound power transmitted from the transducer. You should perform exams according to actual situation and ALARA Principle.

- Click [A. Power] item in the menu to select among percentages.
- The AP value is also displayed at the top of the screen.

### **B Image Display**

- Click [B Image Display] item in the menu.
- Select [On] or [Off] to turn on or off the B Mode image display as live Color remains active.

## **2. Optimizing Color Images**

### **Color gain**

- Rotate the [iTouch] key located on the right side of the control panel.
- The gain value is displayed on the image parameter area.

### **Flow State**

- Click [Flow State] item in the menu.
- Select [Flow State] among L, M and H.

### **Steer**

The Steer feature is used to adjust the Rol of color flow with different angles but with immobility of the linear transducer.

- Click [Steer] item in the menu.
- Change the value.
- This feature is valid only for linear transducers.

## **Invert**

The color bar can automatically invert when the color flow is steered to a certain angle, thus accommodating operator's habit of distinguishing flow direction. However, you can also invert the color bar manually.

To invert the color bar automatically, you need to set it up beforehand.

- Press [Setup] key to show the [Setup] menu.
- Click [System] item to open the [System] screen.
- Click [Image Preset] tab to open [Image Preset] page.
- Check [Auto Invert] item in the [Image] region.

To invert the color bar manually:

- Click [Invert] item in the menu.
- Select [On] or [Off] to invert the color bar.

You also can rotate the [Multifunction] knob to invert the color bar.

## **Priority**

The Priority feature is used to show the flow priority displayed.

- Click [Priority] item in the menu.
- Select among 0% and 100% in increments of 10%.

## **Packet Size**

This feature is used to adjust the accuracy of color flow.

- Click [Packet Size] item in the menu.
- Select among 0, 1, 2 and 3.

## **Color IP**

- Click [Color IP] item in the menu.
- Select among 1 through 8.
- The Color IP value selected is also displayed in the image parameter area.

## **Map**

This feature indicates the display effect of color image.

- Click [Map] item in the menu.
- Select among 1 through 11.
- The Color bar is changed with the Map value change.

## **Wall Filter**

This feature is used to filter the speed signals of the low speed flow.

- Click [Wall Filter] item in the menu.
- Select [WF] values.

## **Line Density**

- Click [Line Density] item in the menu.
- Select between Low and High.
- Note: Changing Line Density will change B Mode frame rate (higher line density / lower frame rate, lower line density / higher frame rate).

## **Smooth**

This feature is used to reject noise and smooth the image.

- Click [Smooth] item in the menu.
- Select among 0 through 4. The smaller the value, the smaller the smooth extent. The bigger the value, the bigger the smooth extent.

**Persistence**

This feature is used for temporal smooth of the image.

- Click [Persistence] item in the menu.
- Select among 0 through 4.

**Contrast**

This feature refers to contrast of color maps.

- Click [Contrast] item in the menu.
- Select among 0 through 3. The smaller the value, the smaller the contrast. The bigger the value, the bigger the contrast.

**Focus Position**

This feature is used to adjust the color focus position relative to the B focus.

- Click [Focus Position] item in the menu.
- Select among 0% through 100% in increments of 10%.
- When the position is changed, the transmit focusing delay changes accordingly.

## 10.3.4 Power / DirPower Mode

Fundamental Power Mode is a non-directionally display of blood flow in the form of intensity as opposed to flow velocity.

DirPower (Directional Power Mode) provides the additional information of flow direction towards or away from the transducer.

The adjustable parameters of Power Mode are consistent with those of the Color Mode. In addition, Dynamic Rang adjusts the contrast resolution of the Power Mode image by compressing or expanding the range of display, and press the soft menu controls to select [Dynamic Range] among 10 and 70 in increments of 5.

Refer to relevant section of the Color Mode and B Mode. The following is to introduce the special items of the Power Mode.

**Map (Power Map / DirPower Map)**

The maps in the Power soft menu are grouped into two categories: Power maps and Directional Power maps. There are four fundamental Power maps and four DirPower maps. The Power maps provide information of flow intensity; the Directional Power maps provides intensity and flow direction.

- Click [Map] item in the menu.
- Select among the values.

**LVR (Low Velocity Rejection)**

The Low Velocity Rejection function is to filter degrees of low velocity flow. Increase or decrease the LVR threshold setting through [LVR] in the Power Mode menu. The bigger the value, the higher the velocity rejected.

- Click [LVR] in the menu.
- Select among 1 through 9.
- Select [Off] to turn on or off this feature.

## 10.3.5 PW/CW Doppler Mode

PW (Pulsed Wave Doppler) mode or CW (Continuous Wave Doppler) mode is used to provide blood flow velocity and direction utilizing a real-time spectral display. The horizontal axis represents time, while the vertical axis represents Doppler frequency shift. If the angle between beam and flow is known, the frequency shift can be converted to flow speed and volume.

Most of the menu items are the same for the PW menu and CW menu, so the PW menu and CW menu are combined together to be introduced here. However, note that adjustment items, such as iTouch, SV, steer, Duplex, Triplex and HPRF, are not available in the CW mode.

### iTouch

After you press the [iTouch] key on the control panel, the system will automatically set the PW baseline and PRF value to the optimum settings according to the current scanned tissue characteristics.

To preset the one-key optimization:

- Press [Setup] key on the control panel to show the [Setup] menu.
- Click [Image Preset] item to open the [Image Preset] screen.
- Click [PW] tab to open the [PW] page.
- Select [iTouch Ratio] among ratio values in the drop-down list on the right box.

Press and hold [iTouch] key to exit the one-key optimization.

### Gain

Rotate the [iTouch] knob on the control panel to increase or decrease the gain.

### Scale

To change PRF:

- Click [Scale] item in the menu.
- Select [Scale] among values.

### PW Steer

This feature is used to steer the SV angle of PW flow with immobility of the linear transducer.

- Click [PW Steer] in the menu.
- Select [PW Steer] among values.

### Invert

The spectrum can automatically invert when the color flow is steered to a certain angle, thus accommodating operator's habit of distinguishing flow direction. However, you can also invert the spectrum manually.

To invert the spectrum automatically, you need to set it up beforehand.

- Press [Setup] key to show the [Setup] menu.
- Click [System] item to open the [System] screen.
- Click [Image Preset] tab to open [Image Preset] page.
- Check [Auto Invert] item in the [Image] region.

To invert the spectrum manually:

- Click [Invert] item in the menu.
- Select [On] or [Off] to invert the spectrum.

You also can rotate the [Multifunction] knob to invert the spectrum.

**Angle**

The angle between Doppler vector and flow is calculated to evaluate the flow speed.

- Click [Angle] item in the menu, and select [Angle] among values; or
- Rotate the [Multifunction] knob to change it.

**Quick Angle**

- Click [Quick Angle] item in the menu.
- Change [Quick Angle] values in increments of 60°.

**Baseline**

This feature is used to accommodate the flow with quicker or slower speed to eliminate alias.

- Click [Baseline] item in the menu.
- Select [Baseline] among 4 through -4.

**SV**

This feature is used to adjust the width of Sample Volume gate in the PW mode.

- Click [SV] in the menu.
- Select [SV] among 0.5 through 15.

**Wall Filter**

This feature is used to remove signals of low speed flow.

- Click [WF] in the menu.
- Change [WF].

**Frequency**

- Click [Frequency] in the menu.
- Select [Frequency] value.

**Duplex and Triplex**

- Duplex allows two modes to be active at the same time.
- Triplex allows three modes to be active at the same time.
- Select [Duplex] as [On] to turn on B + PW.
- Select [Triplex] as [On] to turn on B + PW + Color or B + PW + Power.

**Colorize and Colorize Map**

- Click [Colorize] in the menu to turn on / off the feature.
- Click [Colorize Map] in the menu to cycle through various map schemes.
- Changing Map will also change the color bar.

**Dynamic Range**

The Dynamic Range function is used to adjust contrast resolution of the image to compress or expand the gray display range.

- Click [Dynamic Range] in the menu.
- Select a Dynamic Range value.

**Audio**

- Click [Audio] in the menu.
- Change volume value of Doppler.

**Trace Sensitivity**

- Click [Trace Sensitivity] in the menu.

- Select [Trace Sensitivity] value.

### **Speed**

- Click [Speed] in the menu.
- Select [Speed] value.

### **Acoustic Power**

The acoustic power refers to ultrasound power transmitted from the transducer. You should perform exams according to actual situation and ALARA Principle.

- Click [A. Power] item in the menu to select among percentages.
- The AP value is also displayed at the top of the screen.

### **Auto Trace**

Auto trace is to set V Max and V Mean in the menu.

- **Threshold**

- 1) The [Threshold] setting is only valid for the maximum flow selection.
- 2) Click [Threshold] item in the menu.
- 3) Change the value to increase or decrease Doppler threshold sensitivity.

- **Trace Area**

This feature is used to trace Doppler spectral flow,

- 1) To trace the area above baseline, set Trace Area Top;
- 2) To trace the area below baseline, set Trace Area Bottom;
- 3) To trace the area above and below baseline, set Trace Area All.

- **Trace Smooth**

- 1) Click [Trace Smooth] item in the menu.
- 2) Select among 1 through 4.
- 3) Select [Off] to turn it off.

### **Auto Calc Parameter (Auto Spectrum Calculation)**

The Auto Spectrum Calculation feature is used to calculate PS, ED, RI and PI for Doppler waveform. You can use it on the real time image, frozen image or cine image.

1. Click [Auto Calc] to turn on the auto spectrum calculation;
2. Click [Auto Spectrum Calculation] to check the parameters for auto calculation in the screen;
3. Click [Caliper] key to perform measurements;
4. The results of auto spectrum calculation are displayed in the result window.

Note:

- 1) The result of auto calculation always displays at the top line of the result window, and will not disappear after new measurement calipers are added.
  - 2) In the real time status, the result displayed is always from the latest cardiac cycle.
  - 3) In the freeze and cine status, the result displayed is from the region measured.
5. To delete the result, click [Auto Calc] to turn off the auto calculation.

### **Auto Calc (Auto Calculation)**

Click it in the menu to turn on or off the auto calculation.

1. When it is On, the system will display the Doppler waveform according to the parameters set in the Auto Spectrum Calculation.
2. When it is Off, the auto calculation status is exited and the result disappears from the result window.
3. To show this item in the menu, you shall preset it in the [Image Preset] screen and [Key and Menu Preset] screen.
4. [Auto Calc Parameter]: Click to show the [Auto Spectrum Calculation] screen.
5. Check the parameters for auto calculation. See the figure below.
6. To show this item in the menu, you shall preset it in [Key and Menu Preset] screen.

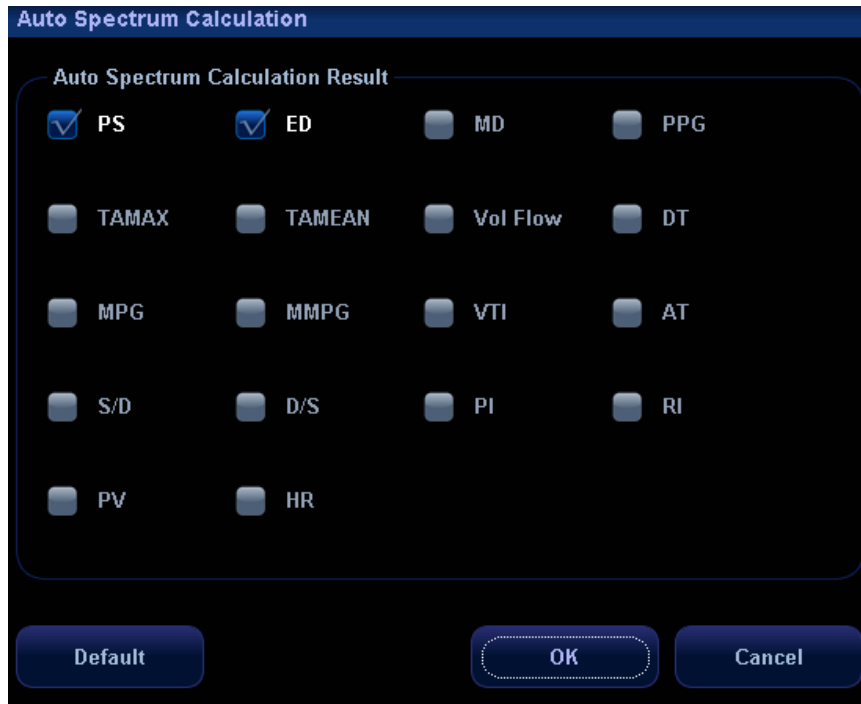

### Trace Area

Click it in the menu to set up trace area for calculating Doppler waveform. It can be used in both real time and freeze statuses.

1. To set it to Above, the area above the baseline is used for calculating Doppler waveform.
2. To set it to Below, the area below the baseline is used for calculating Doppler waveform.
3. To set it to All, all the area is used for calculating Doppler waveform.

### Time Mark

It is used to turn on / off Time Mark within the Doppler Spectral display.

- Click [Time Mark] in the menu.
- Select [On] or [Off] to turn it on or off.

### HPRF (High Pulse Repetition Frequency)

HPRF mode is used when detected velocities exceed the processing capabilities of the currently selected PW Doppler scale or when the selected anatomical site is too deep for the selected PW Doppler scale.

- Click [HPRF] item in the menu.
- Select [On] or [Off] to turn on or off HPRF feature.

### Display Format

- Click [Disp Format] item in the menu.
- Select among L/R, V1:1 (vertical layout with size ratio 1:1), V1:2 (vertical layout with size ratio 1:2) or Full.

## 10.3.6 Image Magnification

- Enter Zoom

In the real time scanning or freeze status, press [Zoom] key to enter the zoom status.

- **Zoom Adjustment**

Rotating the [Multifunction] knob can increase or decrease the magnification factor (maximum is 10 times). Rotating the [Multifunction] knob to the left can decrease the magnification factor; rotating the [Multifunction] knob to the right can increase the magnification factor. The magnification factor is displayed in the image parameter and menu area. For example, Z5.0 indicates the current magnification factor is 5. In the zoom status, rolling the trackball can move the magnified image.

- **Exit Zoom**

Press [Zoom] a second time or press [Esc] to exit the zoom status.

## 10.3.7 iZoom (Full-screen Zooming)

iZoom is used to magnify the area including the image area, parameter area and image banner in full screen.

- **Method:**

- (1) User-defined key setting:
  - a) Open Key Config page via “[Setup]→ [System Preset]→ [Key Config]”
  - b) Select a function-free key in the Function list.
  - c) Select “iZoom” in the Other page.
  - d) Click [OK] to complete the setting.
- (2) Open the image (or the under scanning image), press the defined iZoom key to zoom the area that is described above paragraph to full screen.
- (3) Press the defined iZoom key again to return to normal status.

## 10.4 Image Parameter Preset

**To enter the [Image Preset] screen:**

1. Press the Image Preset item in the Setup menu; or
2. Press the Exam Preset item in the Setup menu to enter the [Exam Preset] screen, and select Exam Config and click .

The image preset is used to set image parameters for a specific transducer in a specific exam type. In this example notice the various settings available for the 3C5s transducer in B / THI Mode, Abdomen exam.



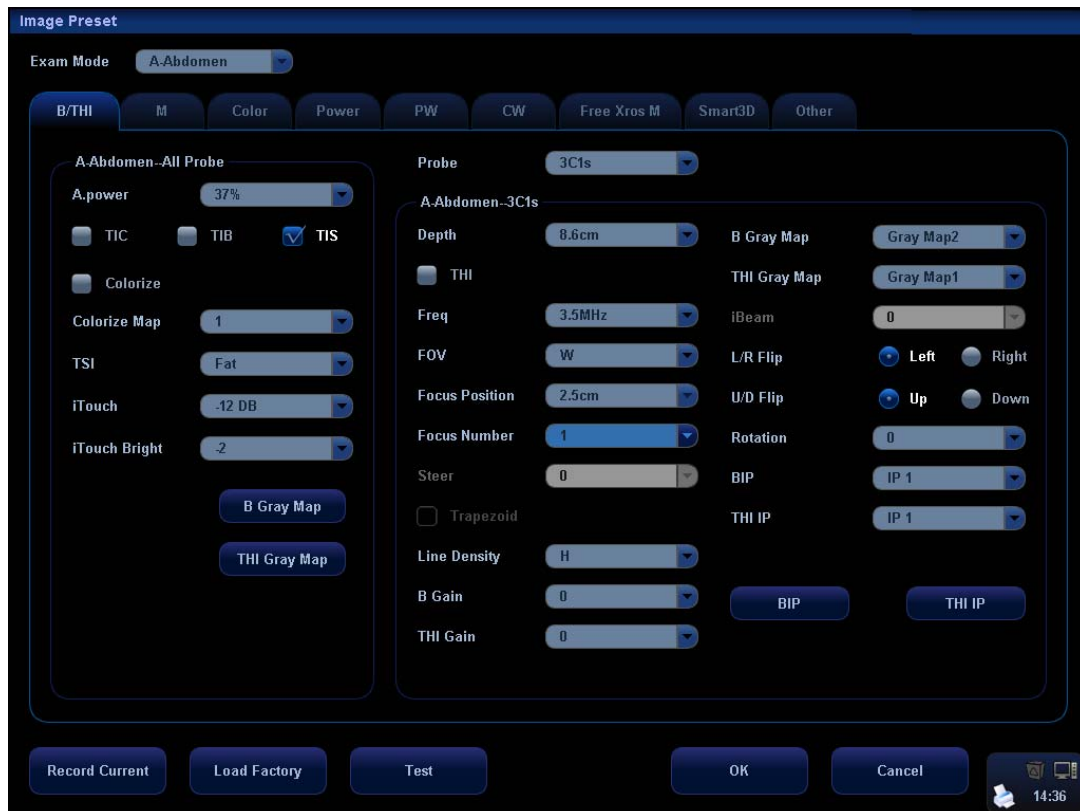

- The [Abdomen - All Probe] field on left side of the screen displays the parameter setup for all transducers in Abdomen exam type.
- The [Abdomen - 3C5s] field on the right side of the screen displays parameter setup for the 3C5s transducer in Abdomen exam type.

The operation of the image parameter setup uses the drop down menus to make numerous selections. The following only introduces [Record Current], [Load Factory], [BIP] and [THI IP], [B Gray Map] and [THI Gray Map].

**Record Current** - Clicking [Record Current] will store all the currently-used setting and values for each preset image parameter.

**Load Factory** - Click [Load Factory], and all parameter settings will be restored to the original factory default.

### B IP and THI IP

Click the [BIP] or [THI IP] button, and the corresponding IP combination of settings can be entered, as shown in the figure below. You can set the parameter values of each IP combination, and click [OK] to store the new setup.



### B Gray Map and THI Gray Map

Clicking [B Gray Map] or [THI Gray Map] on the left field will enter the settings of gray map, as shown in the figure below.

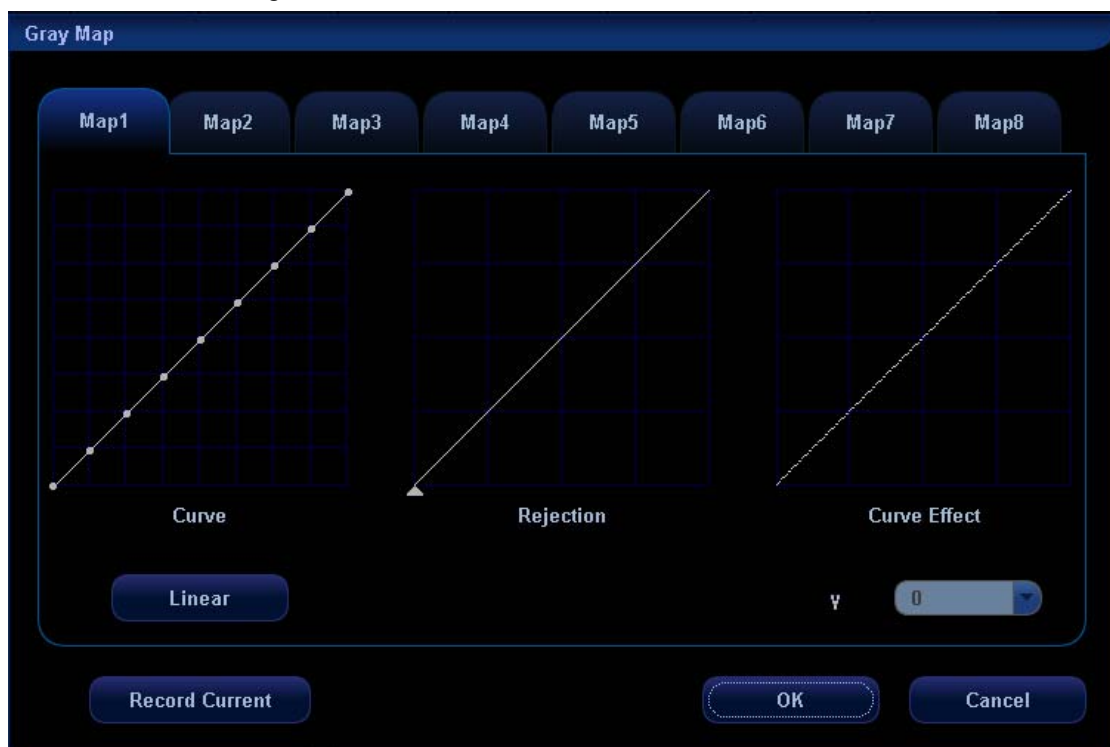

Refer to the relevant B Mode chapter for adjustment of post processing curves.

The system can store 8 different post processing maps, which are selectable through the image menu.

# 11 Special Imaging Modes

---

The system supports the optional imaging modes as follows:

- Smart3D imaging
- iScape panoramic imaging
- Free Xros M imaging

<b>NOTE:</b>	1	The ultrasound images, specially obtained in the Smart3D mode or iScape mode, are provided for reference only, not for confirming a diagnosis. Please use caution to avoid misdiagnosis.
	2	Before you perform the Smart3D or iScape panoramic imaging, you shall preset the parameter items displayed in the menus. The operational steps are as follows: <ul style="list-style-type: none"><li>● Press [Setup] key to show the [Setup] menu;</li><li>● Click the [Key and Menu Preset] item to open the screen.</li><li>● In the Image Mode drop-down list, respectively select 3D Capture, 3D Review, Reset ROI, or iScape Capture;</li><li>● Select items in the Available Items box and move them to the right side in the [Softkey] or [Menu] box.</li><li>● Click [OK] to confirm.</li></ul>

## 11.1 Smart3D

<b>NOTE:</b>	In accordance with the ALARA (As Low As Reasonably Achievable) principle, please try to short the sweeping time after a good 3D imaging is obtained.
--------------	--

### 11.1.1 Note before Use

#### 11.1.1.1 3D Image Quality Conditions

The quality of images reconstructed in the Smart 3D mode is closely related to the object condition, angle of a B tangent plane and scanning technique.

- Angle of a B tangent plane  
The optimum tangent plane is the sagittal section of the face. To ensure high image quality, you'd better scan maximum face area and keep edge continuity.
- Image quality in B mode (2D image quality)  
Before entering 3D capture, optimize the B mode image to assure.
- Scanning technique

- Stability: Body, arm and wrist must move smoothly, otherwise the restructured 3D image distorts.
- Slowness: Move or rotate the transducer slowly. The speed of linear scan is about 2 cm/s and the rotation rate of the fan scan is about  $10^{\circ}/s \sim 15^{\circ}/s$ .
- Evenness: Move or rotate the transducer at a steady speed or rate.

- |                          |   |
|--------------------------|---|
| <p><b>⚠ CAUTION:</b></p> | <ol style="list-style-type: none"> <li>1. A region with qualified image in B mode may not be optimal for 3D imaging.</li> <li>2. More practices are needed for a high success rate of qualified 3D imaging.</li> <li>3. Even with good object condition, to acquire an approving 3D image may need more than one scanning.</li> </ol> |
|--------------------------|---|

### 11.1.1.2 Basic Procedures for 3D Imaging

Basic procedures for 3D imaging are as follows:

1. Select the proper exam mode.
2. Optimize the 2D image.
3. Enter Smart 3D mode.
4. Set ROI (Region of Interest).
5. Capture 3D images.
6. Set VOI (Volume of Interest).
7. Perform 3D browsing and parameter adjusting.
8. Add comment or body mark to an image (the operation for 3D image is the same to the image in other modes).
9. Save necessary images.

## 11.1.2 Smart3D Preset

### 11.1.2.1 Shortcut Key Preset

You can preset a user-defined shortcut key for entering Smart 3D through the path: <Setup>-[System Preset]-[Key Config]. For details, please refer to “17.2 System Preset”.

### 11.1.2.2 Parameter Preset

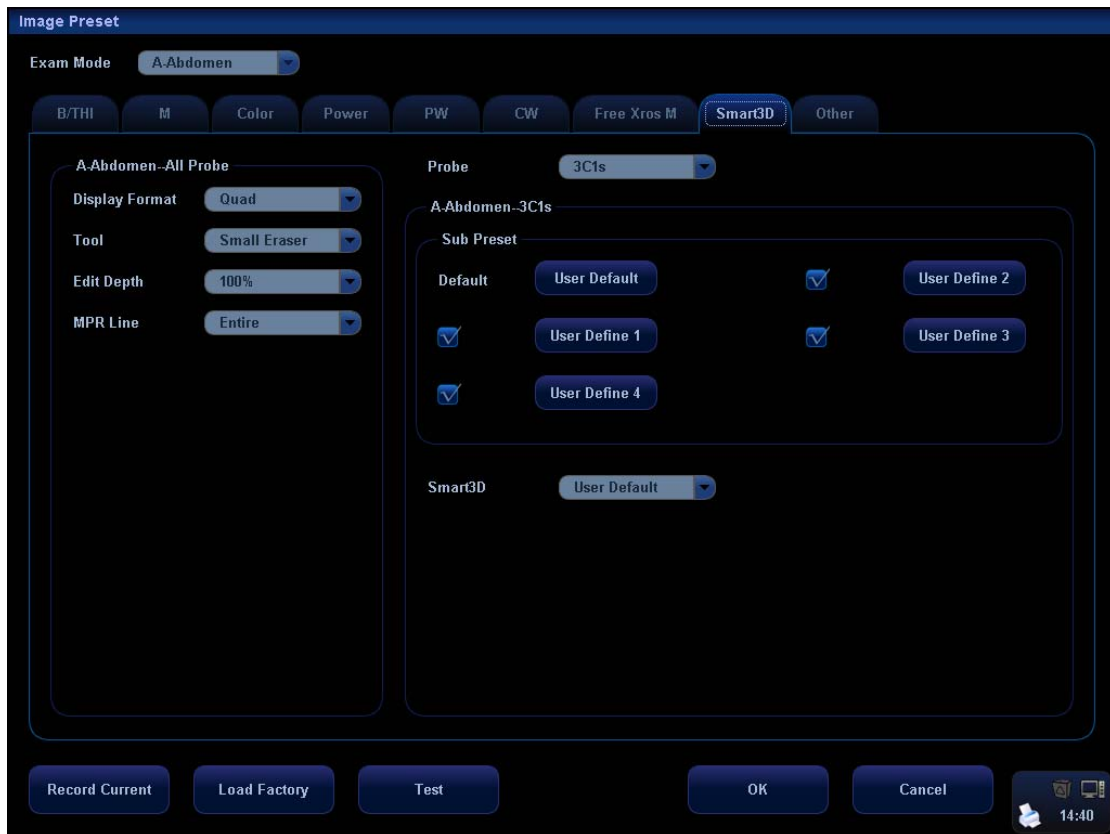

Parameter presetting are the same for different exam mode.

1. Enter the [Preset] menu, select [Image Preset].
2. Select [Smart3D] tab.
3. Preset the 3D parameters according to your preferences, or remain the factory settings. [Image Preset] page is shown in the following figure.



Functions of the parameters are described in the following table.

Parameter	Description
Display Format	To set the image display format in 3D image view status: Single/Dual/Quad
Tool	To set the edit type in image edit mode: <ul style="list-style-type: none"> <li>■ Inside Contour</li> <li>■ Outside Contour</li> <li>■ Inside Rect</li> <li>■ Outside Rect</li> <li>■ Big Rubber</li> <li>■ Small Rubber</li> <li>■ Inside Polygon</li> <li>Outside Polygon</li> </ul>
Edit Depth	To set the edit depth in image edit mode: 0%-100%
MPR Line	To set the display manner of MPR line in image rendering mode: Entire/Partial/Off
Probe	Preset the probe model

Parameter	Description
Sub Preset (Parameter Package Preset)	<p>There are five presettable parameter packages for each mode, which are independent from each other. Every package contains a set of 3D image rendering parameters, and can adopt parameter preset.</p> <p>User Default, User Define1-User Define4</p>  <p>Click ; r check the box before “User Define 1” –“User Define 4”, and click the package button again to preset for the package.</p>
Smart3D	When finished parameter package setting, you can select a default parameter package for Smart 3D imaging.

### 11.1.2.3 Set menu and soft menu items

To set displayed menu and soft menu items in Preview, Smart3D, Edit, Auto Rot. and Reset ROI, refer to “Soft Key and Menu Preset” in Setup chapter for details.

## 11.1.3 Enter/ Exit Smart3D

### ■ Entering

- Press the [Menu] key in any exam mode, select [Other] → [Smart3D] in the displayed menu to enter 3D collecting mode.
- Press the user-defined entering key for Smart 3D to enter 3D image capture preparation status.
- Click [Smart 3D] in the soft menu in B mode.

**NOTE:** The system activates B mode imaging whenever you enter the 3D image preparation status.

### ■ Exit

- Exiting from image acquisition preparation mode  
Click [Exit] in the menu; or press the <Esc> key or the user-defined key to exit Smart3D.
- Exiting from image acquisition mode  
Click [Exit] or press <ESC> to exit to image capture preparation status.
- Exiting from the view status  
Press user-defined key to exit Smart 3D; or press <ESC> to exit to image capture status, and press <ESC> again to exit Smart 3D.

## 11.1.4 3D Image Acquisition Preparation

### 11.1.4.1 Method

You can capture images through linear scan or fan scan.

- Linear scanning

Move the transducer across the surface.

- Sector scanning

Rotate the transducer once from the left to the right side (or from the right to the left) to involve the whole region desired.

### 11.1.4.2 Smart 3D Acquisition Preparation Parameter

Type	Parameter	Description
Acquisition	Start	Function: to begin image acquisition.
	Stop	Function: to stop image acquisition during the procedure.
Parameter Adjustment	Direction	Function: to provide fast adjustment for entering 3D viewing direction in real-time or viewing status. Selection: Up/Down, Down/Up, Left/Right, Right/Left, Front/Back, Back/Front. The common direction used is Up/Down.
	Display Format	Function: to set the image display format in real-time displaying mode or reviewing mode. Selection: Single, Dual, Quad
	Method	Function: to select the probe moving method. Selection: Fan, linear. Linear mode: during the sweep, the probe may not be moved parallel, the speed at which you scan should be constant, about 2cm/s. Fan mode: in this mode, the probe must be moved to a position where you can clearly see a middle cut of the object you want to scan and render. Tilt the probe to about 30 degrees until the object you want to scan disappears. Start the acquisition and tilt the probe over a distance of around 60 degrees until the object disappears again. During the sweep, the probe may not be moved parallel, just tilted. The speed is about 10°/s~15°/s. Tips: the scan speed is determined by scan angle or distance.
	Distance:	Function: to set the distance the probe covered from one end to the other end during the linear sweep. Range: 10—200mm, in increments of 10mm.
	Angle	Function: to set the angle the probe covered during a fan sweep. Range: 10—80°, in increments of 2°.

Type	Parameter	Description
	Reset Curve	To reserve the VOI edge line to be plane.
Sub Preset (Parameter Package Preset)	/	Provides 5 parameter packs. The pack name as well as all the parameters can be preset. Parameter packs of each mode are independent.

## 11.1.5 Image Acquisition

1. Optimize the 2D image of the desired region.
2. Set ROI (Region of Interest) on the 3D image.  
Roll the trackball to change the ROI size and position. You can press the [Set] key to toggle between setting the ROI size or position.  
A small ROI results in an incomplete 3D image, which can be corrected by Resetting ROI after collection. Refer to “11.1.7 Reset ROI” for details.
3. Press the <Update> key or use the soft menu control to click [Start] to start the capture.
4. Perform the capturing according to the scanning technique stated above. (Take the fan scanning as an example).
5. After 3D image is captured, the system enters 3D image viewing status automatically; or, press <Freeze> or click [Stop] in the menu to stop image acquisition to enter 3D image review screen.
6. Browsing and adjusting 3D image.

In image view status, you can adjust the VOI and image parameters to optimize the 3D image, refer to “11.1.6 3D Image Browsing” for details.

## 11.1.6 3D Image Browsing

### ■ Entering/ Exiting Image Browsing

You can finish the 3D capture and enter image browsing by:

Press the [Update] or [Freeze] key, or click [Stop] on the soft menu.

Or, wait until the 3D capture automatically completed.

You can exit the image browsing and start the capture again by:

Press the <Freeze> key or the <Esc> key, or click the [Return] item in the menu.

### 11.1.6.1 Set the Review Window

Click [Display Format] item to adjust the image display mode: single, dual or quad.

Where,



- Select [Single], system displays one image, which can be a section image or a 3D image.
- Select [Dual], system displays two images left and right. (The left one can be sectional A, section B or section C image, and the right one is 3D image.)
- Select [Quad], system displays four images. (The upper left one is section A image, the lower left one is section C image, the upper right one is section B image, and the lower right one is 3D image.)

### 11.1.6.2 Reviewing Sectional Plane Image

The principle of 3D imaging is to restructure a 3D image from multiple 2D image information. The following describes the spatial relation of 3 section plane (A, B and C) and the 3D image.

- Scanning plane and the transducer movement

Arrow in the figure below indicates the movement of the transducer, (you can move the transducer in the contrary direction of the arrow.)

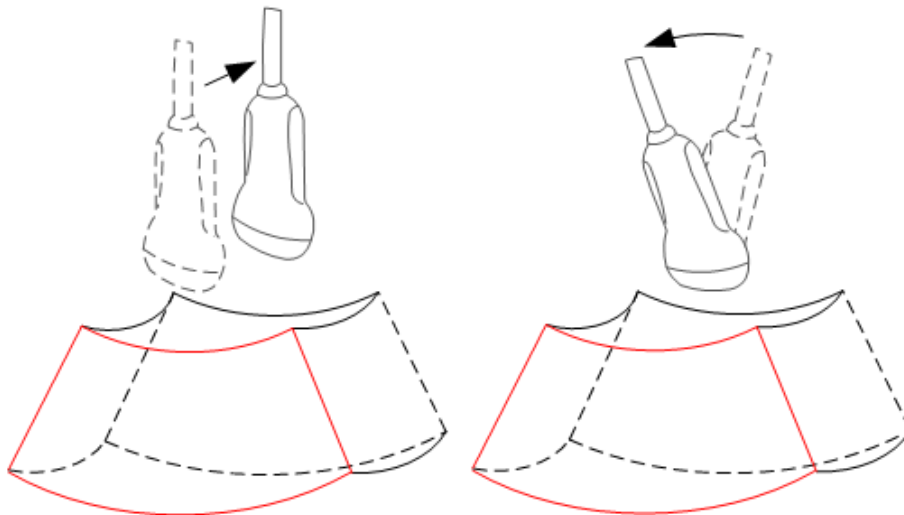

- View the sectional plane image

You can move the section line to view the section image of different position.

1. Click [Current Window] to be A, B or C.
2. Set [Adjusting VOI] to [Off] to enter the section plane viewing.
3. Roll the trackball to review the section image.

Positions of the other two section plane are indicated in the selected plane. You can roll the track ball to change the position. As shown in the figure below.

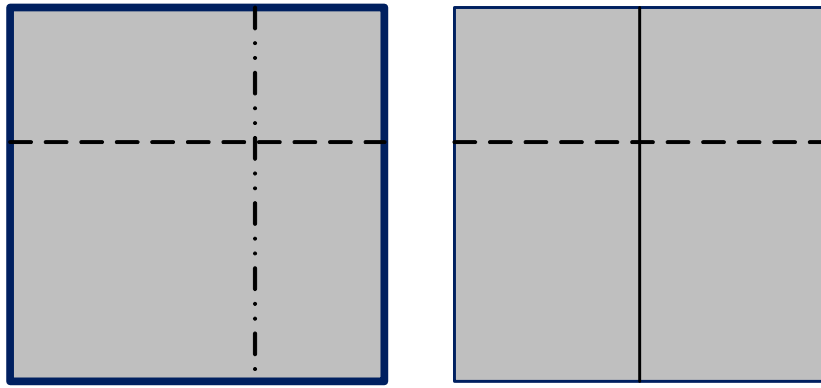

A

B

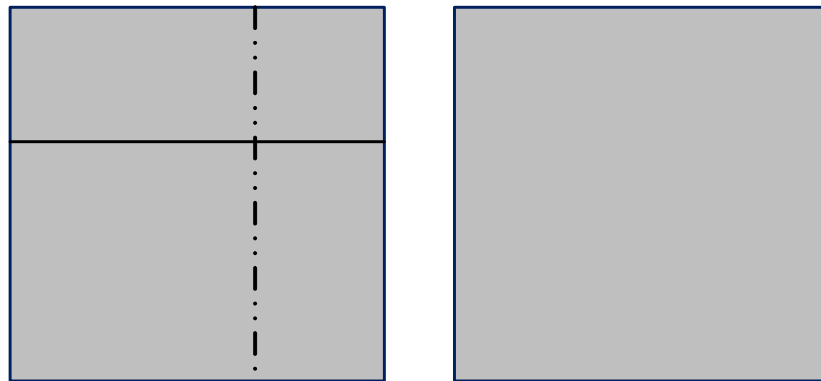

C

D

Section A ——— Section B - · - Section C - - -

E.g. select A as the current window and roll the trackball, section lines (indicate the position of A) in the B and C window move, and image in A window changes.

NOTE:

1. In actual system displaying, different colors of the window box and the section line are used to identify the section A, B and C. Here, three types of line are used.
2. In actual display, the current window's icon is highlighted, e.g., the icon as follows shows that A window is the current window.



A, B, C section images are illustrated as the following sections of 3D image.

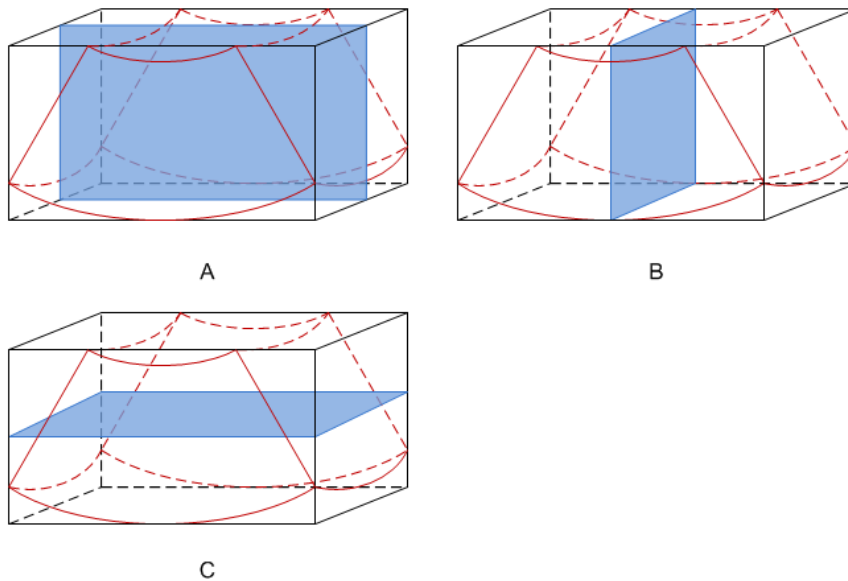

Section A: corresponds to the 2D image in B mode. Section A is the sagittal section in fetal face up posture, as shown in the figure A above.

Section B: it is the horizontal section in fetal face up posture, as shown in the figure B above.

Section C: it is the coronal section in fetal face up posture, as shown in the figure C above.

Tips: the upper part of the 3D image in the D window is corresponding to the orientation mark on the probe, if the fetal posture is head down (orientating the mother's feet), and the orientation mark is orientating the mother's head, then the fetus posture is head down in the 3D image, you can make the fetus head up by rotating the 3D image by clicking [Quick Rot.] to be "180°" in the soft menu.

### 11.1.6.3 Adjust VOI (Volume of Interest)

Adjusting the VOI box size and position is to select the volume data needed to restructure the 3D image and improve the restructure effect. The procedures are as follows:

1. In image browsing mode, click [Adjusting VOI] and set it to [On].
2. Click the [Current Window] to select a current window.  
VOI on section A, B and C are adjustable.
3. Roll the track ball to adjust the VOI size and position. Press <Set> to switch among the status of adjusting VOI position, size and curved VOI.

To exit the VOI adjusting:

Click [Adjusting VOI] item in the soft menu to set it to [Off]. When you roll the trackball to review the image of a section, section lines in the other two planes move correspondingly.

### 11.1.6.4 Adjusting Parameters

In 3D image browsing status, you can adjust the rendering, colorize, smooth and other parameters via 3D view menu and soft menu to optimize the image.

Parameter	Description	
Brightness	Function: to set the brightness of 3D image. Range: 0%-100%. 0% presents the minimum brightness, while 100% the maximum.	
Contrast	Function: to set the contrast of 3D image.	
Colorize	Function: to turn on/off the colorize map display.	
Colorize Map	Function: to display colorize map of the image to optimize 3D image display. Provides 7 colorize maps.	
Method	Function: to select the probe moving method. Selection: Fan, linear.	
Distance (or angle)	The same function as in preparation status.	
Display Format	Function: to set display mode for 3D image viewing.	
Edit	Function: to enter edit status.	
Render	Surface	Function: set Surface as 3D image rendering mode. Applicable for surface imaging, such as fetus face/hand or foot. Top: you may have to adjust the threshold to obtain a clear body boundary.
	Max	Function: set Max as 3D image rendering mode, displays the maximum intensity of gray values in the ROI. This is helpful for viewing bony structures.
	Min	Function: set Min as 3D image rendering mode, displays the minimum intensity of gray values in the ROI. This is helpful for viewing vessels and hollow structures.
	X ray	Function: set X-ray as 3D image rendering mode. Displays the average value of all gray values in the ROI. Used for imaging tissues with different structure inside or tissues with tumor.
Threshold	Function: to set the threshold for 3D image rendering. To render the 3D image using the signal between the high and low thresholds.	
Transparency	Function: to adjust the transparency value for 3D image rendering. The higher the number, the more transparent the gray scale information. Available only in Surface rendering mode.	
MPR Line	Function: using the lines to show the position information of the other sections on a section image or 3D image. Selection: Entire, Partial, Off. Entire means to display the whole line crossing the section image. Partial means to display part of the line at both ends of the MPR line.	

Parameter	Description
Smooth	Function: to set the smoothness of 3D image. Tip: insufficient smoothness can result in a fuzzy image; however, over smoothness will lead to image distortion.
Auto Rotation	Function: to turn on the 3D image auto rotation function.
Direction	Function: to select 3D viewing direction for entering 3D viewing status. Selection: Up/Down, Down/Up, Left/Right, Right/Left, Front/Back, Back/Front. The commonly used direction is Up/Down.
Quick Rotation	Function: to rotate the 3D image quickly. Range: 0°, 90°, 180°, 270°
Inversion	Function: to inverse the grayscale of the image, so as to enhance observation for low-echo region, applicable for vessel, cyst and etc. When the function is turned on, the rendering mode parameters change into the corresponding inverse parameters.
Reset Curve	To reserve the VOI edge line to be plane.
[Return]	To return to 3D acquisition preparation status.

### 11.1.6.5 Rotating Image

The system supports the following rotation modes:

- Sphere center Rotation
- Axial rotation
- Auto Rotation
- Quick Rotation

#### ■ Sphere center rotation

Rotate the 3D image around the center point of the 3D image. The procedures are as follows:

1. Set the 3D window as the current window.

Click [Current Window] to set it to [D], or, you can press the Multifunctional button to display the cursor and click the D window.

2. The system activates sphere center rotation mode by default. You can roll the trackball to rotate the 3D image.

#### ■ Axial rotation

Axial rotation is to rotate the 3D image around the X, Y or Z axis. The procedures are as follows:

To rotate along X-axis: click [X Rotation]

To rotate along Y-axis: click [Y Rotation]

To rotate along Z-axis: click [Z Rotation]

#### ■ Auto Rotation

1. In 3D image viewing status, click [Auto Rot.], the system displays the 3D image only and enters the auto rotation preparation status.
2. Click [Direction] to set the auto rotation direction.
3. Click [Repeat Mode] to set the auto rotation mode.

4. Click [Speed] to set the auto rotation speed.
5. Set the start and end position of the rotation:
  - Start position: roll the trackball to view a certain position, click [Set Start Pos];
  - End position: roll the trackball to view a certain position, click [Set End Pos].
6. Click [Auto Rot.] to be "On" to start auto rotation. You can adjust the speed and mode during rotation.
7. Click [Save AVI to USB] to save the image in AVI format to external devices.
8. To exit auto rotation: click [Exit] or press <ESC> to exit.

**NOTE:** You can view the back of the 3D image by rotating it 180°, but the back view image may not as vivid as the front. (Here we call the initial view of the 3D image you see as "front"). It's recommended to re-capture than to rotate the 3D image remarkably if a region desired is blocked in the initial view.

- Quick Rotation

Click [Quick Rot.]; the 3D image will rotate by 90° every step.

- Image Reset

The 3D image returns to the initial status if you click [Reset] on the soft menu, in rotation mode except auto rotation.

### 11.1.6.6 Zooming Image

- Method for Zoom

Press the [Zoom] key to enter the image magnification status; rotate the [Multifunction] knob to increase or decrease the magnification factor. The maximum zooming factor is 4.

- Correlation between 3D image and planes in Zoom status

When the 3D image is zoomed in or out, the planes is changed along with it.

Set the [Adjusting VOI] to [On], the size and position of VOI do not change. However, set [Adjusting VOI] to [Off], rolling the trackball moves the planes as well.

### 11.1.6.7 Editing Image

Image cutting is a more elaborate function than VOI adjusting to optimize the 3D by clipping (removing) the part blocked the region of interest.

- Entering/ Exiting:

Click [Edit] to enter/ exit the cutting status.

Image cutting is unavailable in single window display mode.

1. Click [Edit] to enter/ exit the cutting status.
2. Click [Edit Tool] to set the tool for cutting.
3. Set the cutting depth.
4. Roll the trackball and press the <Set> key to position a start point, roll the trackball to set a region and press the <Set> key again, the selected region is cut.
  - If the Inside Contour/Outside Contour/Inside Polygon/Outside Polygon is selected, the region that will be cut is defined when the start point and the end point coincide.
  - If the Eraser mode is selected, with the eraser moving the region that will be cut is defined in real time.

Click [Undo] in the soft menu to undo the last cutting; click [Restore] to restore the cut region; or click [Undo All] to undo all cuttings.
5. Click [Exit] to exit the cutting status.

Parameters are described as follows:

Type	Parameter	Description
Edit Type	C. inside	Allows you to trace the portion of the image you want to cut. Inside Contour removes all portions of the image that fall inside your traced region.
	C. outside	Allows you to trace the portion of the image you want to cut. Inside Contour removes all portions of the image that fall outside your traced region.
	R. inside	Displays a box you can use to define the portion of the image you want to cut. Inside Rect removes all portions of the image that fall inside the box.
	R. outside	Displays a box you can use to define the portion of the image you want to cut. Outside Rect removes all portions of the image that fall outside the box.
	Eraser. B	Provides a big eraser tool you can use to define the portion of the image to cut by hand.
	Eraser. S	Provides a small eraser tool you can use to define the portion of the image to cut by hand.
	P. outside	Allows you to trace a polygon on the image you want to cut. Outside Polygon removes all portions of the image that fall outside your traced region.
	P. inside	Allows you to trace a polygon on the image you want to cut. Inside Polygon removes all portions of the image that fall inside your traced region.
Edit Depth	Depth	Function: allows you to define the image depth to be cut. 3D image changes in real time along with the depth. Full: the full depth of the selected region will be cut. Define: allow you to define the depth to be cut. When [Full Depth] is "Off", you can define the depth by clicking [Edit Depth]. The range is 0%-100%, in increments of 5%.
Other Operations	Undo	To undo the last cut only.
	Redo	To restore the cut region.
	Undo All	To undo all cuts since you entered image edit mode.
	Done	Click to confirm the edit.

Tips: if you click [Reset ROI] item, all operations for image editing will be cleared.

### 11.1.6.8 Comment and Body Mark

■ Function:

Add comment and body mark to the sectional planes and 3D image.

■ Operation:

The operation is the same as adding comment and body mark in B image mode.

### 11.1.7 Reset ROI

Reset ROI is to reset the region of interest to rebuild the 3D image.

It's performed on Freeze images.

- NOTE:**
1. Resetting ROI is not to re-capture or re-collection images but to rebuild 3D image with the image data collection already. Usually, when the ROI set before capture is not the optimal one, you can reset it to improve the 3D imaging effect.
  2. Resetting ROI cannot improve 3D image with a bad imaging condition.

The procedures are described as follows:

1. In the 3D Review mode, click the [Reset ROI] item of the 3D review menu to reset ROI. Use the [Set] key and trackball to set the ROI size and position.
2. After the ROI is reset, click the [Reimaging] item in the menu to enter the [3D Review] screen. The system will create a new 3D image based on the reset ROI.
3. If you click [Reset ROI] item, all operations for cutting will be cleared.
4. In the Reset ROI status, press [Cine] to enter the cine review; press [Esc] or [Update] to return the 3D review mode.

### 11.1.8 3D Images Storage and Review

#### ■ Image saving

- In the 3D viewing mode, press the image-saving key (Save Image to hard drive) to save the current image to the animal information management system.
- Save clip: in 3D viewing mode, press the cine-saving key to save CIN-format clip to the hard drive.
- Save AVI as USB: in auto rotation mode, click [Save AVI to USB] to save the auto rotation images to the USB disk.

#### ■ Image review

Open an image file to enter the image review mode. In this mode, you can perform the same operations as what you can do in 3D image viewing mode.



## 11.2 iScape

The iScape panoramic imaging feature extends your field of view by piecing together multiple B frames into a single, extended B image. Use this feature, for example, to view a complete hand or thyroid.

When scanning, you move the transducer linearly and acquire a series of B images. After the scan is complete, the system will piece these images together into single, extended B image.

After you obtain the extended image, you can rotate it, move it linearly, magnify it, add comments or body marks, or perform measurements on the extended image.

You can perform the iScape panoramic imaging feature on B real time images using all linear and convex transducers.

**⚠ CAUTION:**

iScape panoramic imaging constructs an extended image from individual image frames. The quality of the resulting image is user-dependent and requires operator skill and additional practice to become fully proficient. Therefore, the measurement results can be inaccurate. Exercise caution when you perform measurements in the iScape mode. Smooth even speed will produce optimal image results.

**NOTE:**

The measurement error is within 5% in the iScape mode.

### 11.2.1 Enter or Exit iScape

**To enter iScape mode:**

- Move the cursor onto [iScape] item in the Other menu, and press the [Set] key;

**To enter the iScape mode via a user-defined key:**

- Assign a key (F1 through F4, or left & right keys of footswitch) as user-defined iScape panoramic imaging.  
The setting path is "Setup → System → Key Config". Refer to section 17.2 for details.
- Press the user-defined iScape panoramic imaging key to quickly enter the mode.

**To exit iScape mode:**

- If in the capture status, click [Exit] in the menu; or press the [Esc] key.
- If in the review status, press [Esc] to exit to the capture status, and then press [Esc] again to exit iScape mode.

## 11.2.2 Capture Images

- 1 To enter the iScape capture mode:
  - Move the cursor onto the [iScape] item in the Other menu and press the [Set] key; or
  - Press the user-defined iScape panoramic imaging key on the control panel.
- 2 Press the [Update] key or use the soft menu control to click [Start iScape] to start the iScape image capture.
- 3 Scan slowly and in a uniform motion lengthwise, end-to-end (with or against the transducer orientation mark), to obtain a single extended field of view image.
- 4 Press the [Update] key or [Freeze] key or use the soft menu control to click [Stop iScape] to end the image capture and freeze the screen. The image splicing starts. After the acquisition is complete, the extended image will be displayed. The iScape review mode is entered.
- 5 To exit the iScape review or enter the capture mode to recapture images:
  - Press the [Freeze] key; or
  - Press the [Esc] key; or
  - Select [Return to Capture] in the menu.
- 6 To exit iScape in the iScape capture mode:
  - Press the [Esc] key; or
  - Press the [B] key; or
  - Press the user-defined iScape panoramic imaging key.

## 11.2.3 Review the Extended Image

After completing the image capture, you can piece images together and then enter the iScape review mode.

- **Rotate iScape image**

In the iScape review mode, click [Rotation] in the menu to rotate the extended image clockwise or counterclockwise.

- **Magnify iScape image**

In the iScape review mode,

- 1 Press the [Zoom] key to enter the zoom status.
- 2 Rotate the [Multifunction] knob to change the magnification.
- 3 Roll the trackball to change position of the magnified image.
- 4 Press the [Zoom] key again to exit the zoom mode.

- **Set parameters**

In the iScape review mode, using the soft menu controls to select the soft menu items, you can set Actual Size, and Fit Size.

- **Other**

In the iScape review mode, you can perform measurements, add body marks or comments.

- **Evaluate image quality**

Many variables may affect the overall image quality. It is important to evaluate the image content and quality before an image is used for diagnosis or measurements.

**NOTE:** iScape panoramic imaging is intended for well-trained ultrasound operators or physicians. The operator must recognize image artifacts that will produce a sub-optimal or unreliable image.

The following artifacts may produce a sub-optimal image. If the image quality cannot satisfy the following criteria, you shall delete the image and capture it again.

- The Image must be continuous (no part of an image moves suddenly or disappears.)
- No shadow or absent signal along the scan plane.
- Clear profile of anatomy through the entire scan plane without distortion.
- Skin line is continuous.
- The images are captured from the same plane.
- There is no large black area in the image.

## 11.2.4 Review the Captured Images Frame by Frame

In the iScape review mode, you can review the captured images frame by frame, or perform measurements on these images.

### To review the images:

- 1 Click [Review Cine] in the menu and enter the cine review mode. The cine review will start in manual fashion.
- 2 Roll the trackball to review the captured images frame by frame.
- 3 Move the cursor onto the start of the cine loop, click [Set First Frame] in the menu to set the start point.
- 4 Move the cursor onto the end of the cine loop, click [Set End Frame] in the menu to set the end point.
- 5 Click [Auto Play] in the menu to set the value (except 0), and the system enters the automatic cine review. The review region is between the set start point and end point.
- 6 Click [Auto Play] to change the value (except 0), thus the speed of the cine review is changed.
- 7 Click [Auto Play] to set the value to 0, and the system stops the automatic cine review and enters the manual cine review.
- 8 Click [iScape] in the menu, or press [Update] or [Esc] to enter the iScape view status; the splicing image is displayed.

## 11.2.5 Save and Open Images

In the mode for reviewing an extended image,

- 1 Press user-defined saving key (with user-defined saving function) to save the extended image to the default position, in the format FRM (Single-frame images can be transformed to PC format: JPG, BMP, TIFF or DCM files. Refer to chapter 16 for details.).
- 2 Click [Save Cine] item in the menu to save the extended image and its series of images acquired, in the file name with suffix CIN. The file can be transformed to PC format: AVI or DICOM files. Only the extended image can be sent.

**In the mode for reviewing series of images acquired,**

- 1 Press [Save] key (with user-defined saving function) to save the single-frame image to the default position, in the format FRM.
- 2 Click [Save Cine] item in the menu to save the extended image and its series of images acquired, in the file name with suffix CIN. The file can be transformed to PC format: AVI or DICOM files. Only the series of images acquired can be sent.

## 11.3 Free Xros M Mode

For an image in the traditional M mode, the M-mark line goes along the beams transmitted from the probe. Thus it is difficult to obtain a good plane for difficult-to-image animals that cannot be moved easily. However, in the Free Xros M mode, you can manipulate the M-mark line to move to any position at desired angles.

### 11.3.1 Settings for Free Xros M

#### 11.3.1.1 Shortcut Key Preset

Define the shortcut key for entering Free Xros M mode through the path: <Setup> - [System Preset] - [Key Config], refer to “17.2 System Preset” for details.

#### 11.3.1.2 Parameter Preset

Set Free Xros M image parameters through the path: <Setup>- [Image Preset] - [Free Xros M].

### 11.3.2 Enter/Exit Free Xros M

#### ■ Enter Free Xros M

In B or B+M mode, press the user-defined shortcut key, or click [Free Xros M] on the soft menu.

#### ■ Exit Free Xros M

In Free Xros M mode, click [Free Xros M] or press <B> to exit Free Xros M mode, or press the user-defined shortcut key again to exit.

### 11.3.3 Imaging

#### ■ Real-time Imaging

1. In real-time B mode or B+M mode, adjust the probe and image to obtain the desired plane.

2. Click [Free Xros M] in the soft menu or menu to enter Free Xros M mode, or press the user-defined key.
3. Adjust the M-mark (single or multiple) line to obtain optimized images and necessary information.

In Dual-split or Quad-split mode, it is the current activated window that enters the Free Xros M Mode.

#### ■ Imaging in Freeze Mode

1. Free Xros M imaging of images in cine memory
  - For B frozen images, press <M> or press the user-defined key directly.
  - For B+M frozen images, press the user-defined key directly.
  - For B+PW/ CW frozen images, enter single-B cine memory first and press <M> on the control panel, or press the user-defined key.
  - If it is in the dual-split or quad-split scanning, it is the current activated window that enters the Free Xros M mode, and click [Dual] to switch between the images in dual-split or quad-split B mode images.
2. Adjust the M-mark line (single or multiple) and image parameters to obtain optimized images and necessary information.

### 11.3.4 Free Xros M Image Parameters

- In Free Xros M mode imaging, the image parameter area in the upper left corner of the screen displays the real-time parameter values as follows:



Display	G 62	V 3
Parameter	Free Xros M Gain	Free Xros M Speed

- Parameters that can be adjusted to optimize the Free Xros M mode image are indicated in the following.

Adjustment	Items
Control Panel	Gain, TGC
Menu and Soft Menu	Colorize, Post Process (γ, curve, gray rejection), Display Format, Display, Time Mark, Angle, Speed, Gray Map, Colorize Map

- During real-time Free Xros M mode imaging, menus for B mode, Free Xros M mode and other modes are displayed in the soft menu at the same time, use the left/right keys of soft menu controls <4> to switch the menus.
- Parameters consistent with those in M mode are not to be introduced, please refer to relevant section of the M mode, while special items of the Free Xros M mode will be introduced in the following.
- Items that appear in the menu or the soft menus are dependent upon preset, which can be changed or set through "[Setup] → [Image Preset]"; please refer to "17.8 Soft-key and Menu Preset" for details.

- Display or Hide the M-mark Line

**Description** There are 3 M-mark lines available, each with a symbol of "A", "B" or "C" at one end as identification and an arrow on the other end as a mark for direction.

**Operation** Click [Show A], [Show B], [Show C] in the soft menu or menu to display or hide the sampling line, and the corresponding image will be displayed on the screen once the related item is selected.

**Impacts** When there is only one M-mark line on the screen, you cannot hide it.

- Switching between the M-mark Lines

**Description** To switch between the M-mark lines in Free Xros M mode.

**Operation** Press <Set> to switch between the M-mark lines and press the multifunctional knob to show the cursor.

The activated M-mark line will be green and the inactivated one will be white.

- Adjustment of the M-mark Line

**Description** To adjust the position and angle of the M-mark line.

**Operation** ● Position Adjustment

When the M-mark line is activated, move the trackball left and right to adjust the position. The direction is recognized by the arrow at the end of the line.

● Angle Adjustment

When the M-mark line is activated, move the trackball to adjust the fulcrum of the line, and adjust the angle via the [Angle] in the soft menu or the multifunctional knob.

The adjusting angle range is 0-360.

- Display

**Description** This function is to adjust the display of the images when there is more than one M-mark line.

**Operation** Adjust through the [Display] item in the soft menu or menu.

You can choose to display image of the current M-mark line or the all.

# 12 Cine Review

---

After you press the [Freeze] key, the system allows you to review and edit the images prior to the image frozen. This function is called as cine review. The magnified images can also be reviewed after the [Freeze] key is pressed, and the operating method is the same. You can change post processing maps, perform measurements, add comments and body marks on the images being reviewed.

The system supports manual review as well as automatic review. The default setup is Manual

Cine, but you can switch between Auto Cine and Manual Cine.

In addition, the system supports the images reviewed along with ECG waveforms, if the detection of ECG waveforms is performed.

<b>⚠ CAUTION:</b>	<ol style="list-style-type: none"><li><b>1 Cine Review images can be inadvertently combined in-between separate animal scans. The Cine Review memory must be cleared at the end of the current animal and the onset of the next new animal by selecting the [End Exam] key on the control panel.</b></li><li><b>2 Cine files stored in the system's hard drive shall contain animal information, to avoid the selection of an incorrect image file and potential misdiagnosis.</b></li></ol>
-------------------	--

## 12.1 Entering / Exiting Cine Review

**To enter Cine Review:**

- Press [Freeze] key to freeze an image, and the [Cine] key indicator lights on;
- The system automatically enters the manual cine status.

**To exit Cine Review:**

- Press [Freeze] key again, the system will return to image scanning and exit cine review.
- Press [Cine] key or [Esc] key, the images are still frozen but the system exits cine review.

## 12.2 Cine Review in the B or C Mode

### 12.2.1 Manual Cine Review

After the cine review is entered in the B or C mode, rolling the trackball will display the cine images on the screen one by one. If you roll the trackball to the left, the review sequence is

reversed to the image-storing sequence, thus the images are displayed in descending order. Whereas, if you roll the trackball to the right, the review sequence is the same as the image-storing sequence, thus the images are displayed in ascending order. When you review images until the first or the last frame, further rolling the trackball will display the last or first frame.

The cine progress bar at the bottom of the screen (as shown in the figure below): the whole bar represents the total frame number. The two numerals in the lower right corner respectively indicate the current frame number and the total frame number. The slider indicates the frame position currently reviewed.



## 12.2.2 Auto Cine Review

- 1 In the manual cine review, use the soft menu control to click [Auto Play] in the menu to activate auto cine review.
- 2 In the auto cine review, use the soft menu control to click [Auto Play] in the menu to adjust the review speed. When the speed is changed to 0, the system exits the auto cine review.
- 3 In the auto cine review, rolling the trackball will stop the auto cine review and enter to the manual cine review.

## 12.3 Cine Review in the M or D Mode

Enter the cine review in the M or D mode, and then roll the trackball, the cine images are displayed on the screen one by one. Roll the trackball to the left, the review progress slider moves to the left, the images moves to the right, and the earlier stored images are invoked. Whereas, roll the trackball to the right, the review progress slider moves to the right, and the images move to the left, the recently stored images are invoked. When you review the images until the earliest or the latest frame, further rolling the trackball will not move the image leftward or rightward.

The cine review progress bar is displayed at the bottom of the screen (as shown in the figure below). The two numerals in the lower right corner respectively indicate the current time and the total time.



To switch between Auto Cine and Manual Cine, the method is identical to that of the B or C mode.

## 12.4 Linked Cine Review

In dual live status, the linked cine review refers to review of the images captured at the same moment. You can perform the linked cine review in the following modes:

- B + M
- dual live mode (B + Color or B + Power)
- duplex mode (B + PW)
- triplex mode (B + PW+ Color or B + PW+ Power)

In the statuses rather than the dual live, you can only review images in the currently active window.



Refer to sections 12.1 through 12.3 for cine review operations. However, the images in the linked cine review are displayed synchronously in B + M, B + Color, B + Power, B + PW, B + PW+ Color or B + PW+ Power mode.

## 12.5 Setting Region of Auto Review

You can set a segment of cine loop which can be reviewed automatically. After the auto review region is set, the auto cine review can only be performed within this region; but the manual cine review can be performed beyond this region. When the cine file is saved, only the images within this region are saved.

After the system enters the cine review status, perform the following procedures to set the region. After the process of setting is complete, two triangle marks will appear at the two ends of the region (as shown in the figure below):

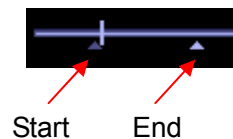

### Method 1

- 1 Manually review the images until the frame which you want to set it as start point, and use the soft menu control to click [Set First Frame] in the menu to set the start position.
- 2 Manually review the images until the frame which you want to set it as end point, and use the soft menu control to click [Set End Frame] in the menu to set the end position.
- 3 Use the soft menu control to click [Auto Play] to set the value (except 0), the auto cine status is entered, and adjust the review speed through this control.
- 4 Use the soft menu control to click [Save Cine] in the menu to save the cine images in the set region.

### Method 2

- 1 Manually return images to the first image to be reviewed, and press the [Menu] key to open the cine menu, and click [Set First Frame] to set the start position.
- 2 Press the [Menu] key to close the cine menu, and the system returns to the cine review status.
- 3 Manually return images to the last image to be reviewed, and press the [Menu] to open the cine menu, and click the [Set End Frame] to set the end position.
- 4 Click [Auto Play] to set the value (except 0) and the auto review is entered.
- 5 Rotate the [Multifunction] knob to adjust the review speed.
- 6 Press the [Menu] key to open the cine menu and click [Save Cine] to save the cine images in the set region.

## 12.6 Saving Cine

In the freeze status, you can save the cine files with auto review regions into the system as CIN files. There are two ways:

- 1 Use the soft menu control to click [Save Cine] in the menu to save the file to the default position of the system.
- 2 Click [Save Cine] in the cine menu to save the file to the default position of the system.

## 12.7 Cine Setup

### 12.7.1 Setting Cine Length

You can set the cine length in the system setup screen. Enter the system setup screen, and open the [General] page. In the Storage field, the Cine Length item is located in the middle, as shown in the figure below.



For Time without ECG (s), the unit is second (s), and it refers to the duration from the moment of freezing counted down to the set time point.

For Time (ECG Loop), the unit is number of cardiac cycles, which can only be selected through the drop-down menu. The cardiac cycles can be selected in the range between 1 and 16.

### 12.7.2 Setting Cine Memory Split

You can set the cine memory split through the path Setup → System → Image Preset. Select Auto or Split for Cine Memory in the Image Preset page.

“Auto” for the cine memory indicates the system splits the cine memory as per the number of B image windows; “Split” indicates the system always splits the cine memory, even if in the single-B window, the system splits the cine memory into two as well. You can press the [B] key to switch and display the images in either memory, so you can compare images in “Split”. The memory capacity is evenly distributed as per splitting number, as shown in the following table (Taking B images in low density as an example, the capacity of B cine memory is N frames):

Image Split Mode	Single-B	Dual	Quad
Auto	One memory, with capacity N frames	The memory splits into two, with capacity N/2 frames each	The memory splits into four, with capacity N/4 frames each
Split	The memory splits into two, with capacity N/2 frames each	The memory splits into two, with capacity N/2 frames each	The memory splits into four, with capacity N/4 frames each

# 13 Measurements

---

- |                   |   |   |
|-------------------|---|---|
| <b>⚠ WARNING:</b> | 1 | Be sure to measure areas of interest from the most optimal image plane to avoid misdiagnosis from inaccurate measurement values.  |
|                   | 2 | To obtain accurate Doppler flow measurement values, make sure the transmitting beam is not perpendicular to the flow, otherwise false readings and potential misdiagnosis may result. |

- |                   |   |  |
|-------------------|---|--|
| <b>⚠ CAUTION:</b> | 1 | If an image is unfrozen or the mode is changed during a measurement, the calipers and measurement data will be cleared from the screen. The general measurement data will be lost (the application measurement data are stored in the report). |
|                   | 2 | If the system is turned off or [End Exam] is selected during a measurement without entering the animal information, the data not saved will be lost.   |

## 13.1 Basic Operations

### 13.1.1 Enter Measurement Status

To enter the measurement status, press [Caliper] key or [Measure] key.

- Press [Caliper] key to enter general measurement status;
- Press [Measure] key to enter application measurement status.

To exit the measurement status:

- Press [Caliper] key or [Measure] key again.

You can perform measurements on a:

- zoomed image
- cine review image
- real-time image
- frozen image

### 13.1.2 Measurement Result and Help Information

The system displays and updates measurement results in the result display area.

The Help information concerning measurement and calculation is displayed in the Help bar at the bottom of the screen.

## 13.2 General Measurements

### 13.2.1 General Measurements – 2D

The 2D general measurement consists of B, Color and Power / DirPower general measurements. The measurements listed below can be performed in 2D:

Measurement tool	Function
Distance	The distance between two points of interest.
Depth	The distance between transducer surface and the probing point along ultrasound beam.
Angle	The angle between two intersected planes.
Area	The area and / or perimeter of a closed region.
Volume	The volume of a target.
Cross line	The length of two line segments, which are perpendicular to each other.
Parallel line	The distance between each pair of parallel lines in a sequence.
Tracing length	The length of a curve.
Length ratio	The lengths of any two lines and the calculated ratio.
Area ratio	The areas of any two regions and the calculated ratio.
B histogram	The grayscale distribution of ultrasonic echo signals in a closed region
B profile	The grayscale distribution of ultrasonic echo signals across a line
Color speed	Color flow speed (only valid for Color mode)
VF Diam	To measure vascular diameter

### 13.2.2 General Measurements - M Mode

The measurements listed below can be performed in the M Mode:

Measurement tool	Function
Distance	The vertical distance between two points.
Time	The time interval between any two points.
Slope	The slope is calculated by means of measuring the distance and time between two points.
Heart rate	In the M heart beat image, n intervals ( $n \leq 8$ ) are measured to calculate an M Mode derived HR value in Beats Per Minute (BPM).
Velocity	After the distance and time between two points are measured, the average velocity can be calculated between the two points.

### 13.2.3 General Measurements - Doppler

General measurements in the D mode are also called “Doppler measurements.” The measurement tools are as follows.

Measurement tool	Function
Time	The time interval between any two points.
Heart rate	N intervals ( $n \leq 8$ ) are measured to calculate a PW Mode derived HR value in Beats Per Minute (BPM).
D Speed	On the Doppler mode image, speed and PG (pressure gradient) of a point on the Doppler spectrum waveform are measured.
Acceleration	Speeds and time interval between two points are measured to calculate speed difference and acceleration.
PS / ED	Speed and PG between two peaks on the Doppler spectrum to calculate RI (resistance index) and PS / ED (peak systolic / end diastolic).
D Trace	On the PW mode image, one or several Doppler waveforms are traced to obtain speed and PG, etc.
VF Diam	To measure the vascular diameter.
Vol Flow(Diam)	To measure the vascular diameter and max (average) velocity to calculate the flow volume.

## 13.3 Application Measurements

- **Abdomen measurements** - Used for measurements of abdominal organs (liver, gall bladder, pancreas and kidney, etc.) and large abdominal vessels.
- **OB measurements** - Used for measurements of fetal growth indexes (including EFW) as well as GA and EDD calculations. The fetus can be evaluated through growth graph analysis and fetal biophysical profile.
- **Cardiac measurements** – Used for left ventricle function measurements and measurements of main artery and vein parameters.
- **Gynecology measurements** - Used for the uterus, ovary and follicles, etc.
- **Small Part measurements** – Used for small parts such as thyroid.
- **Urology measurements** - Used for prostate, seminal vesicle, renal, adrenal, micturated and testicle volume.
- **Orthopedics measurements** - Used for hip joint measurement.
- **Peripheral vessel measurements** – Used for carotid, cerebral, upper and lower extremities vessels, etc.

# 14 Comments (Annotations)

---

**⚠ WARNING:** You must ensure that the entered comments are correct. Incorrect comments may cause misdiagnosis!

Comments can be added to an ultrasound image to bring to attention, notate or communicate information observed during the examination.

**You can add comments to:**

- zoomed image;
- cine review image;
- real-time image;
- frozen image.

**You can:**

- type the character as comments;
- insert the pre-defined comments from the comment library;
- insert arrow markers.

## 14.1 Entering / Exiting Comments

**To enter the comment status:**

- 1 Press the [Comment] key to enter the comment status, and the cursor becomes “|”.
- 2 Press any alphanumeric key to enter the comment status, and the corresponding letter or numeral is displayed besides the cursor.
- 3 Press the [Arrow] key to enter the arrow-adding status.

**To exit the comment status:**

- 1 In the comment status, press the [Comment] key.
- 2 In the comment status, press any of other operating mode keys, such as [Caliper], [Measure] etc.
- 3 In the arrow-adding status, press the [Arrow] key.

## 14.2 Comment Menu

### 14.2.1 Comment Text Library Menu

After entering the comment status, pressing the [Menu] key will show or hide the Comment Text Library menu. From these menus, you can add comment texts selected from the menu items. The Comment Text Library menus consist of menus for Abdomen, Cardiac, GYN

(Gynecology), OB (Obstetrics), Urology, SMP (Small Part), PED (Pediatrics), Nerve, EM and Vascular.

To customize the comment text library, press [Setup] key to select [Comment Preset] and open the comment preset screen. After you customize the comment text library for an exam, you will see the customized comment texts when you open the comment text library menu in this exam mode.

To navigate to comment text library of other exams, move the trackball onto the title of the comment text library menu, and selections of other exams will display. See the screen below.

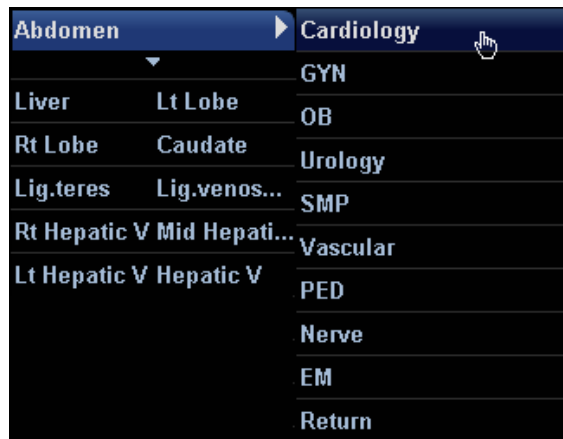

## 14.2.2 Soft Menu for Comments

You can use the soft menu controls to click the soft menu items to set home of comments, change font size or arrow size, navigate to comment text libraries of other exams, select language of comments, to delete comment, or delete word. See the figure below.



### ■ Setting Home of Comments

Move the cursor to the desired location for a comment and click [Set Home]. The current position of the cursor is set to be the default position of the comment adding.

When clicking [Home], the cursor will return to the default setting position. And in all probe and all imaging modes, the cursor is in the setting position when entering comment status.

Assign the user-defined key for the set home function in “[Setup] → [System Preset] → [Key Config]”.

### ■ Changing Font Size/Arrow Size

To change font size of comment text, click [Font Size] to select among Small, Middle and Large. To change arrow size, click [Arrow Size] to select among Small, Middle and Large.

### ■ Navigating Through Comment Text Libraries

To navigate through the comment text libraries, click [Library] to change among comment text libraries. The default is the comment text library in the current exam mode.

### ■ Changing Language

Click [English] to turn on or off the English comments. If turning on the English comments, the comments will display in English; if turning off the English comments, the comments will display in the language you set in the preset.

If the current language is English, the language selection is not available.

### ■ ABC Display

Click [ABC Display] to display or hide the added comments. Assign the user-defined key for the function in “[Setup] → [System Preset] → [Key Config]”.

### ■ Delete a word or all comments

Click [Erase All Text] to delete all texts.





Click [Delete Word] to delete the word in the reserved order.

## 14.3 Adding Comments

### 14.3.1 Typing Comment Characters

You can perform the following operations either in the comment status or in the other statuses.

- 1 To set the comment location:

Roll the trackball or press  ,  ,  or  key to move the cursor to the desired location for comments.

- 2 To type the alphanumeric characters:

- Type the alphanumeric characters through the qwerty (The default characters are uppercase);
- To type the upper characters, press [Shift] and the character key at the same time.

- 3 New line:

In the edit status (the characters are in green color), press [Enter] to move the cursor to the new line, and the location of the cursor is aligned with that of the first line.

- 4 In the edit status, press [Set] or [Enter] to confirm the character added, and the color of the character added turns to yellow.

### 14.3.2 Adding a Comment Text

- 1 Enter the comment status and set the comment location. The method is the same as that mentioned above.

- 2  Rotate the [Multifunction] knob to display the comment texts one by one in the current exam mode.

- 3 Or press [Menu] key, and the comment text library menu of the current exam mode will be displayed on the left side of the screen. You can navigate to the comment text library menus for other exam modes.



- 4 To select the comment text:  
Move the cursor onto the desired comment text on the menu and press [Set], and then the system adds the selected comment text on the set location. The added comment text is in the edit status, so you can change the comment text added.
- 5 Or you can use an initial of a comment text to search the complete comment text.  
Move the cursor to the desired location for adding the comment text, and enter the initial of a comment text, then rotate the [Multifunction] knob to display the comment texts one by one.
- 6 Once you find the desired comment text, press [Set] or [Enter] to confirm the comment text and exit the comment status. The added comment text turns to yellow color.

### 14.3.3 Adding an Arrow

You can add an arrow to a location where you want to pay attention.



- 1 Press the [Arrow] key, and an arrow will appear in the default position. You can move the arrow, change the orientation of the arrow, or delete the arrow.
- 2 To position the arrow to the area of interest:  
Roll the trackball to the desired position.
- 3 To change the orientation of the arrow:  
  
Rotate the [Multifunction] knob to change the arrow orientation (in 15° increments).
- 4 Use the soft menu control to click the [Arrow Size] item of the soft menu to change the size of the arrow: Small, Middle or Large.
- 5 Press [Set] or [Enter] to anchor the Arrow position, and the arrow turns to yellow color.
- 6 Repeat the above steps to add more arrows.
- 7 Press [Arrow] to exit the arrow-adding status.

## 14.4 Moving Comments

- 1 Move the cursor onto the comment that needs to be moved. Press the [Set] key to select it, and at this time a highlighted box appears around the comment.
- 2 Roll the trackball to move the comment to the new position.
- 3 Press the [Set] key to anchor the comment in the new position, and the comment-moving operation is complete.

## 14.5 Modifying (Editing) Comments

### 14.5.1 Modifying (Editing) Characters

- 1 Move the cursor on the comment that needs to be modified, and press the [Set] key to select it.
- 2 Press the [Set] key again to enter the edit status.
- 3 Use the  or  key to move the cursor to a location where needs to insert characters, and type characters or select the new comment text from the comment text library menu.
- 4 Press the [Del] key to delete the comment character or text on the right side of the cursor.
- 5 Press the [Backspace] key to delete the comment character or text on the left side of the cursor.
- 6 Roll the trackball or press the [Set] key to confirm the modification and to exit the edit status, and the color of the comments turns to yellow.

### 14.5.2 Modifying (Editing) Arrows

- 1 Move the cursor on the arrow that needs to be modified. After the cursor turns to , press the [Set] key. The color of the current arrow turns to green, and there is green frame around the arrow, indicating the arrow can be edited. Move the cursor to modify the arrow position.
- 2 Rotate the [Multifunction] knob to modify the arrow direction.
- 3 Press the [Set] key to complete the modifying operation.

## 14.6 Deleting Comments

### 14.6.1 Deleting Comment Characters, Texts or Arrows

- 1 Move the cursor to a position where you need to delete the comment, whether a character, a text or an arrow.
- 2 Press the [Set] key to select the comment to delete.
- 3 Press the [Del] or [Back] key to complete the deleting operation, and the cursor turns to the comment cursor.

### 14.6.2 Deleting a Recently-Added Character, Text or Arrow

After you add several comments and the cursor is in the “|” or “↔” status, pressing [Back] can delete the recently-added or recently-edited comment.

### 14.6.3 Delete Word

Click [Delete Word] to delete the word in the reserved order.

You can also assign the corresponding shortcut key through the path: <Setup> - [System Preset] - [Key Config].

### 14.6.4 Deleting All Comments (Characters, Texts or Arrows)

Click [Erase All Text] to delete all the comment items on the screen. You can also assign the corresponding shortcut key for the function in “[Setup] → [System Preset] → [Key Config]”.

Pressing the [Clear] button long can remove all onscreen content from the image area including comment characters, texts and arrows, as well as measurement calipers.

- Clear comments automatically:

It can be set if to clear the comment when the image is unfrozen or the probe or exam is changed. The setting path is: “<Setup> → [System Preset] → [General] → [Comment]”.

- |  |
|--|
| <p><b>NOTE:</b></p> <ol style="list-style-type: none"><li>1. When no object is selected, pressing the [Clear] key will clear all comments and all measurements calipers.</li><li>2. After powering off, the system will clear all comments on the image.</li></ol> |
|--|

## 14.7 Comment Preset

You can customize font size and arrow size, or define comments for an exam mode.

### 14.7.1 Font Size and Arrow Size

You can set font size and arrow size via the path: <Setup> → [System Preset]→ [General] → ABC.

Also you can set if to clear comments automatically during freezing or changing probe/exam.



### 14.7.2 User-defined Comments

You can customize user-defined comments for an exam mode according to your preferences. The customized comments will display in the corresponding exam mode. The operational steps are as follows:

- 1 To open the [Comment Preset] screen, select Comment Preset in the Setup menu.  
The following example is comment preset in Abdomen mode. See the figure below.



- 2 Select the desired exam mode.
- 3 Enter Library Name: you can enter characters for the library name, or accept the default name (the same as that for the exam mode).
- 4 Add user-defined comments: directly enter comment texts, or select comment texts for the comment library.

Directly enter comment texts: Enter the user-defined comment in the box above [Add Comment], and then click [Add Comment], the added comment will be updated to both "Available Items" as well as "Selected Items". In addition, you can click [Set] on a selected item and edit the selected item.



Note: the directly-entered or edited comments will be added to the library

- Select Available Items: First select a comment library in the drop-down list beside "Available Items", and then click [Set] on one item displayed below "Available Items". Click  to add one item to the box on the right side.

To add all items on the left side to the right side, click .

- 5 Change the selected items on the right side: select an item on the right side box and click [Up], [Down], [Left] or [Right] button to move the position of the item.
- 6 Withdraw or Delete a user-defined comment:

- Withdraw an item (from the library or user-defined) in the Selected Items box:

Select an item in Selected Items box, and click  to withdraw it to the Available Items box. To withdraw all items, click .

Note: After an item is withdrawn to the Available Items box, it will not appear in the comment menu.

- Delete a user-defined item in the Available Items box:

Select a user-defined item in the Available Items box, and click [Delete] under the box (See the figure below). After the user-defined item in the Available Items box is deleted, the same item in the Selected Items box will disappear as well.

Note: You can only delete the user-defined items rather than the items in the system library. After a user-defined item is deleted, it will not be available.



- After you customize comments, click [OK] to confirm and exit the [Comment Preset] screen.

# 15 Body Marks (Pictograms)

---

The Body Mark (Pictogram) feature is used for indicating the exam position of the animal and transducer position and orientation.

## 15.1 Entering / Exiting Body Mark Mode

To enter the Body Mark status:

Press  to enter the body mark selection status.

To exit the Body Mark status:

1. Press [Body Mark] again to exit the body mark status;
2. Press the [Esc] key to confirm the current operation and exit the body mark status.

## 15.2 Categories of Body Marks

The Body Marks are grouped into Dog, Cat, Equine, Bovine, Ovine or Other. Each category consists of multiple pictograms that can be selected or preset according to your workflow requirements.

## 15.3 Soft Menu for Body Marks

The body mark soft menu displays the setups in the current mode:

- Click [Library] to select [Dog], [Cat], [Equine], [Bovine], [Ovine], [Other] and show the corresponding body marks.
- Select Display On or Off to turn On or Off the Body Mark feature.
- Select Page Down to turn pages of the body marks. If there is only one page, selecting this button will not change anything.
- Current BM (Body Mark) 1<sup>st</sup>

The Current BM (Body Mark) has two statuses, “1<sup>st</sup>” and “2<sup>nd</sup>”. The Current BM 1<sup>st</sup> is default.

- a) To add two body marks on an image, after you add one body mark, you shall move the cursor onto the Current BM 1<sup>st</sup> and press [Set] to show the Current BM 2<sup>nd</sup>.
- b) Click [Current BM] to switch between the current operating body mark.

## 15.4 Adding Body Marks

The following will describe the steps to add the first Body Mark graphic to the imaging window.

- 1 Enter the Body Mark status; use the soft menu control to click [Library] to select the body mark category. The exam-dependent body marks will appear above the soft menu.
- 2 Move the cursor onto the desired body mark to highlight your choice (See the figure below). If there are two or more pages of body marks, use the soft menu control to click [Page Down] to turn the pages.



- 3 Press [Set] to anchor your selection.
  - 4 To adjust the transducer position and orientation marker:
    - a) Roll the trackball to place the transducer marker in the correct position;
    - b) Rotate the [Multifunction] knob to adjust the orientation;
    - c) Press the [Set] key to confirm the position and orientation of the transducer marker and exit the Body Mark mode.
- To add a second Body Mark graphic after the first body mark is added:
    - 1 Press [Body Mark] on the control panel. Select the body mark category by pressing the leftmost item of the soft menu. The exam-dependent body marks will appear above the soft menu.
    - 2 Use the soft menu control or move the cursor onto the Current BM 1<sup>st</sup> and press [Set] to show the Current BM 2<sup>nd</sup>.
    - 3 Add the second body mark according to the steps previously noted for the 1<sup>st</sup> graphic, as above.



## 15.5 Moving Body Marks

You can move the Body Mark graphic to any desired position within the image area.

- 1 Roll the trackball to move the cursor onto the Body Mark graphic. The cursor becomes , indicating you can move the pictogram to a new position.
- 2 Click the [Set] key to select the Body Mark graphic, a frame will now appear around the graphic.
- 3 Roll the trackball to move the Body Mark graphic to the desired position.
- 4 Click the [Set] key to anchor and confirm the new graphic position.

<b>NOTE:</b> In Dual B Mode, a Body Mark cannot be moved between the separate image windows.
--

## 15.6 Deleting Body Marks

- **To delete a Body Mark:**

- 1 Use the trackball to position the selection pointer over the Body Mark graphic.
- 2 Click the [Set] key to select the Body Mark graphic.
- 3 Press the [Clear] key to delete the selected body mark.

<b>NOTE:</b> In the Body Mark mode, if no object is selected, pressing the [Clear] key will clear all comments, body marks and general measurements from the screen.
--

- **Delete body marks in reversed order**

In the body mark status, press the [Back] key to delete the body marks in the reversed order.

## 15.7 Body Mark Preset





In order to accommodate your workflow – numerous preferential settings can be captured in Body Mark Preset. This function is to preset,

1. body marks in each exam type, or
2. user-defined body marks.

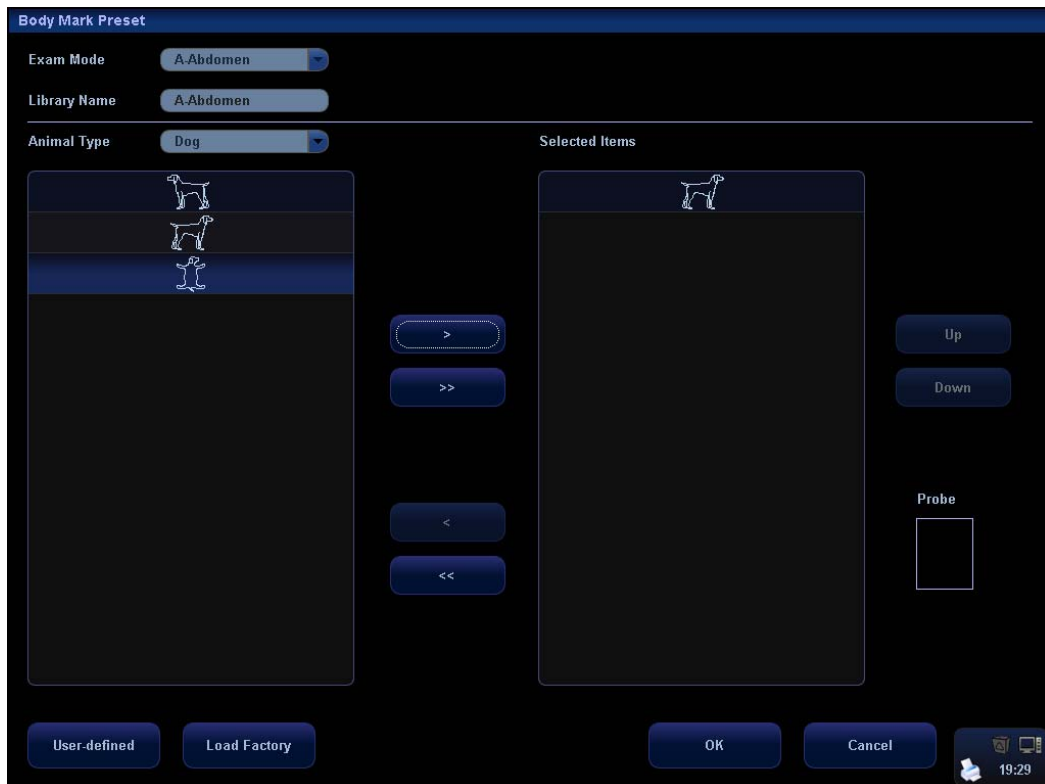
### 15.7.1 Preset Exam Type Body Mark Preferences

- 1 Select the [Body Mark Preset] item in the Setup menu and enter the [Body Mark Preset] screen (as shown in the figure below).



- 2 Select the exam type that you will preset the Body Mark presets from Exam Mode drop down menu.
- 3 Set library name: enter the name for the setting body mark library.
- 4 Select the application region where the body mark is applied through the Application Region drop-down list.
- 5 Select the desired pictogram, and click  to add it to the column on the right side. The functions of ,  and  are the same as

those described in the “Comment Preset”.

- 6 You can arrange the order of the selected pictograms in the column on the right side, by using either the [Up] or [Down] button.
- 7 To preset the probe location and orientation on the body mark:
  - Select a body mark in the Selected Items box;
  - Move the cursor onto the body mark in the Probe Info box;
  - After the cursor becomes , press [Set] and a green probe appears;
  - Moving the trackball can change location of the green probe; rotating the [Multifunction] knob can change the orientation.
  - Press [Set] to confirm the new location and orientation and the probe becomes yellow.

- **User-defined Body Marks**

If there is no Body Mark pictogram from the Body Mark library, you can create a graphic of your own.

A dark blue rectangular button with the text "User-defined" in white.

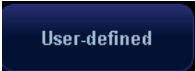
In the body mark preset screen above, click  to enter the user-defined body mark screen (as shown in the figure below).

Note: You can edit, delete, or export a user-defined graphic. In addition, you can create a Body Mark graphic with a draw tool or add it from loading. The method of loading and exporting is similar to that in the comment preset. The file format is \*.BIN. The following is only to introduce the manual edit of body marks.

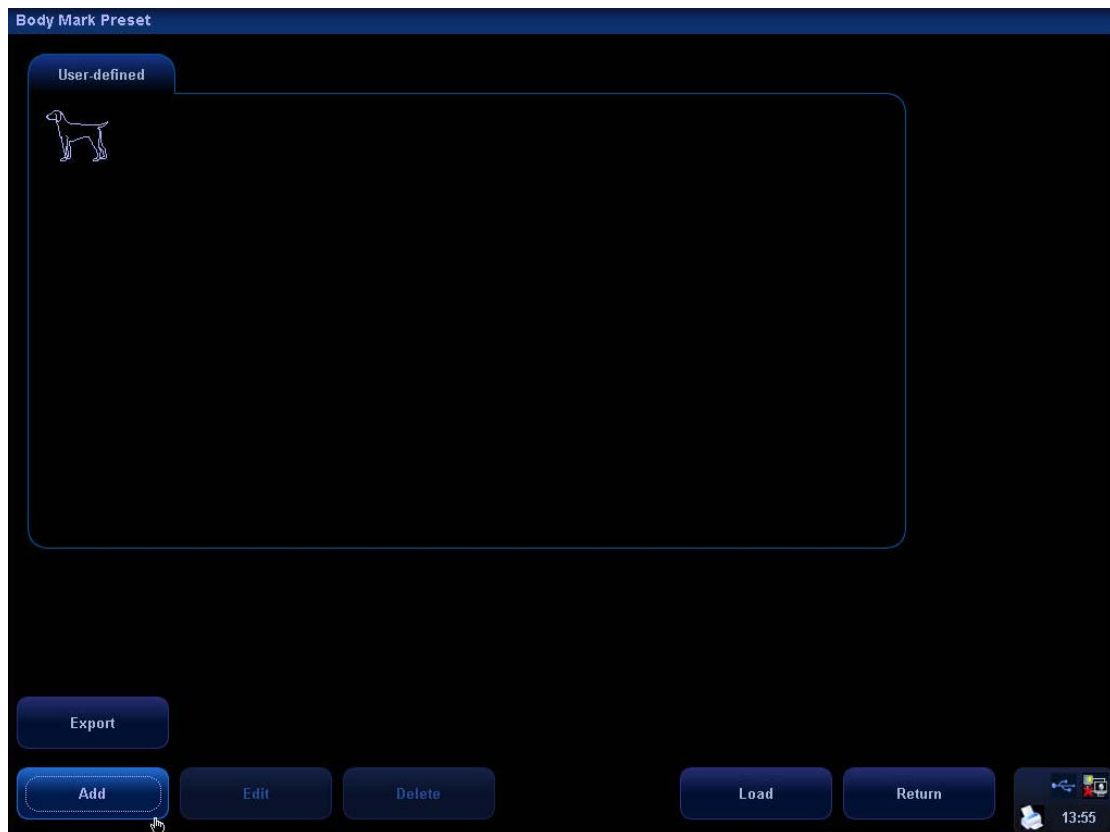

**To add user-defined body marks:**

- 1 Click the [Add] button on the screen to enter the creation selection screen of Body Mark. You can select to copy an existing body mark or draw a new graphic.

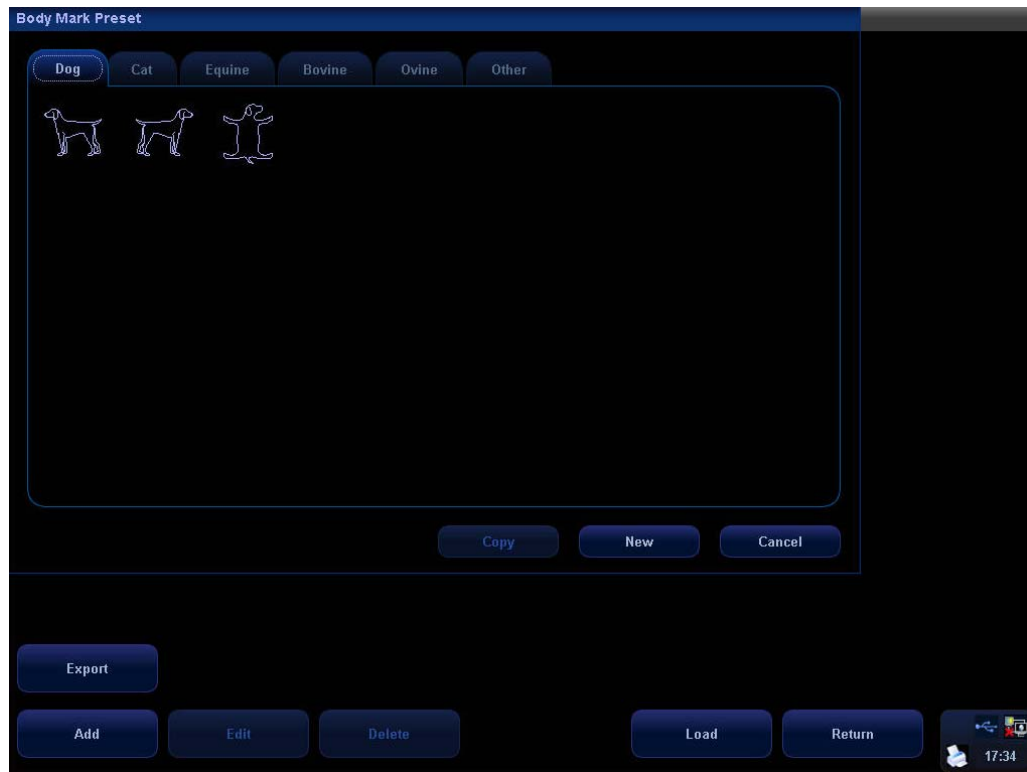

- 2 Select a body mark on the current screen and click [Copy] to enter the body mark drawing screen, thus you can edit the copied body mark. In addition, you can click [Add] to enter body mark drawing screen:

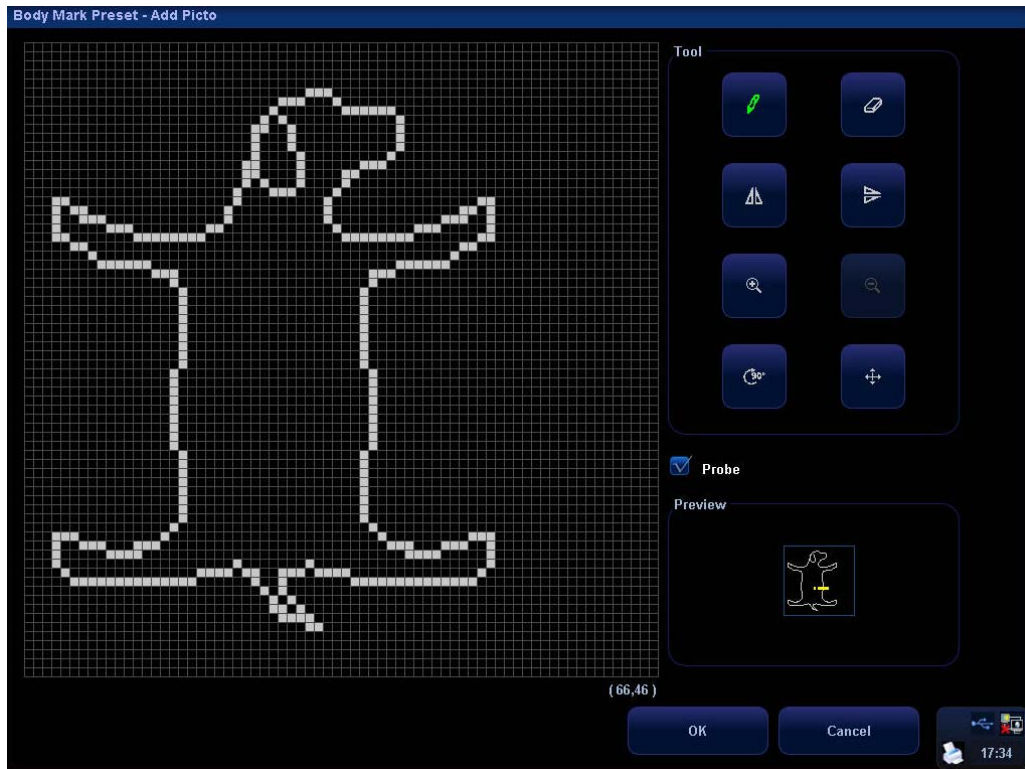

- 3 The drawing tools are described as follows; select from among the tools to create your own specialized graphic.

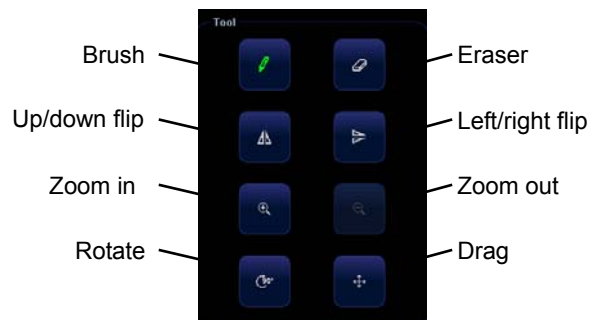

- 4 You can select  **Probe** on the screen, to adjust position of the transducer indicator on the body mark and rotate the [Multifunction] knob to change direction of the indicator.
- 5 After the drawing of a body mark is complete, click [OK] to save it and exit the user-defined body mark status.
- 6 After selecting a user-defined body mark, click the [Edit] button to edit it; or click the [Delete] button to delete it.

# 16 Data Management

---

An exam record consists of all information and data of one exam.

An exam record consists of the following information:

- Animal information and exam data
- Image files
- Report

NOTE: 1. DO NOT use the internal hard drive for long-term image storage. Daily backup is recommended. External storage media is recommended for image archive.

2. The system animal database space is limited, please back up or clear animal data in time.

3. Mindray is not responsible for lost data if you DO NOT follow suggested backup procedures.

## 16.1 Animal Information Management

### 16.1.1 Enter Animal Information

The general animal information and exam information are entered through the Animal Info screen, for details; please refer to “8.2 Animal Information”.

After completion of animal information entry, click [OK] to save the animal information to the animal data.

### 16.1.2 Animal Information Setting

Enter “General Preset” screen through the path: [Setup](by pressing <Setup>)->[System Preset]->[General Preset].

You can perform the following settings if necessary in the Animal Info area:

- Display setting
- H&W Unit

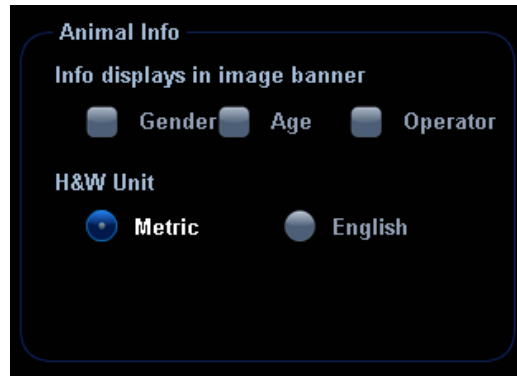

## 16.2 Image File Management

You can store the image files either in the animal database in the system, or to external memory devices. For a saved image, you can perform operations like image reviewing, analyzing and demonstration (iVision).

### 16.2.1 Memory Media

System supported memory media including:

- System hard disk
- USB memory devices: USB flash drive, removable USB hard disk
- DVD+R, DVD+RW, DVD-R, DVD-RW, CD-RW, CD-R
- DICOM Storage server
- VCD/DVD recorder

### 16.2.2 Image File Formats

The system supports two types of image file formats: system-relevant and PC-compatible.

#### ■ System-relevant formats:

- Single-frame image file (FRM)  
Refers to single-frame static image files not to be compressed; you can perform measurements and comments adding on this type of files.
- Cine file (CIN)  
System-defined multi-frame file format; you can perform manual or auto cine review, and perform measurements or add comments for the reviewed images. After you open a stored CIN file, the system automatically enters cine review status.

The system can save FRM files as BMP, JPG, TIFF or DCM files, or save CIN files as AVI, DCM files. The system can also open FRM, JPG, BMP and CIN files.

#### ■ PC-compatible formats:

- Screen file (BMP)  
Single-frame file format, used to save the current screen, non-compressed format.
- Screen file (JPG)  
Single-frame file format, used to save the current screen in the compressed format; you can set the compression ratio.
- TIFF: Single-frame export format



- Multi-medium files (AVI)  
Multi-frame file format, general cine file format.
- DICOM files (DCM)  
DICOM standard files format, single-frame or multi-frame format, used to record animal information and images; you can only open DCM files to view rather than to edit, which is identical to JPG format.

### 16.2.3 Image Storage Preset

#### ■ Set image size

You can set the image size via “[Setup](by pressing <Setup>)->[System Preset]->[General]”. The items are shown as follows:



#### ■ Set single frame export format

##### ● Format

You can select the image export format in the “Send To” dialogue box.

You can set the JPG compression ratio via “[Setup](by pressing <Setup>)->[System Preset]->[General]”.

**NOTE:** Compression in a JPEG format may result in image distortion.

#### ■ Set cine saving length

- Live capture
- Clip length

#### ■ Set send/ print image after end exam

Open “[Setup](by pressing <Setup>)->[System Preset]->[General]”, check “Send/ Print Image after End Exam” in “Animal Management” area. Then every time you press <End Exam>, the system will send images of the exam to the connected default DICOM server.

### 16.2.4 Saving Images to the System

#### ■ To save a single-frame image in the system:

- a) Set the user-defined key through the path: [Setup] (by pressing <Setup>)->[System Preset]->[Key Config]. Select a key in the Key Function page on the left side and select “Send Single Frame Image to Local Disk” in the Output page of Function field on the right side.
- b) Press the user-defined key to save the image.

- In the image screen, press the user-defined key to save the current single-frame image, and the image is saved with the default file name in the default file directory in the FRM format. The thumbnail of this image will appear in the thumbnail area on the right side of the screen. When you move the cursor onto the thumbnail, its filename with suffix will be displayed.
- When a dialog box is displayed on the current screen, press the user-defined key to save the screen in the BMP format.
- To save cinelooop image in the system:
  - (1) Set the user-defined key through the path: [Setup] (by pressing <Setup>)-> [System Preset]-> [Key Config]. Select a key in the Key Function page on the left side and select "Send Cine to Local" in the Output page of Function field on the right side.
  - (2) Press the user-defined key, cine file is saved in CIN format with the image frozen.

The saving file is named by default (usually contains information like animal ID or name). If no animal information is entered, the system will create an animal ID while saving the image.

The thumbnail of this image will appear in the thumbnail area on the right side of the screen. When you move the cursor onto the thumbnail, its filename with suffix will be displayed.

## 16.2.5 Quickly Saving Images to USB Flash Drive

Use user-defined keys to quickly save the single-frame or cine to USB flash drive.

The image file is stored in the directory: U disk\ US Export\ animal folder\ exam folder\ xxx.bmp, here,

- Animal folder name: animal name+ animal ID
- Exam folder name: exam mode+ exam time
- To store single-frame image to USB flash drive:
  - (1) Set the user-defined key through the path: [Setup](by pressing <Setup>)-> [System Preset]-> [Key Config]. Select a key in the Key Function page on the left side and select "Send Image to USB disk (S1)" in the Output page of Function field on the right side.
  - (2) Press the user-defined key to save the image to the USB flash drive.
- To store cine to USB flash drive
 

Save cine images to a USB flash drive in the AVI format.

  - (1) Set the user-defined key through the path: [Setup] (by pressing <Setup>)-> [System Preset]-> [Key Config]. Select a key in the Key Function page on the left side and select "Send AVI cine to USB disk (S2)" in the Output page of Function field on the right side.
  - (2) Press the user-defined key to save the cinelooop.



## 16.2.6 Quickly Saving Full Screen Image to the System

This function can save the current full screen image to the system with the image in real-time status.

1. Set the user-defined key through the path: [Setup] (by pressing <Setup>)→ [System Preset]→ [Key Config]. Select a key in the Key Function page on the left side and select "Send Full Screen Image to Local" in the Output page of Function field on the right side.
2. After the setting, you can use the user-defined key to save full screen image to the system in BMP format.

## 16.2.7 Thumbnails

The stored images or cineloops are displayed in the form of thumbnails on the screen:

- In the iStation screen, the thumbnails refer to the images stored for the selected exam or the selected animal.
- In the scanning or freeze mode, the thumbnails refer to the images stored in the current exam. You can click  or  to turn the pages when there are more than one page.
- In the Review screen, the thumbnails refer to the images stored in the same exam.
- When you move the cursor onto a thumbnail, its name and format will be displayed.

## 16.2.8 Image Review and Analysis

You can review and analyze the stored images (only refer to the images stored in the system default path).

### 16.2.8.1 Review an Image

You can review all images stored in an exam, and send, delete or analyze the stored images.

- To enter Review:
  - Press <Review> to enter Review screen. The system displays the images stored in this exam of the current animal (if there is no current animal information, you can review the images of the latest exam).
  - Select an exam of an animal in the iStation screen, and press <Review> to enter the Review screen to review the images of the animal. You can also select more than one exam, and the system will display images of the lately exam images in Review status.

The Review screen is shown as follows:



■ To exit Review:

- Click [Exit] on the Review screen; or,
- Press <ESC> or <Review> again.

■ Basic operations

Select an exam item in the Exam History area. The selected item is highlighted. Click [Info] or [Report] to view animal information or report. Double-click a thumbnail to view and analyze an image. Rotating the Multifunctional knob will navigate through thumbnails.

The function buttons are described as follows:

- Exam History:
  - You can select one certain exam from the exam directory to review the images.
    - If entered from iStation, the screen displays the record(s) selected in the iStation.
    - If entered from the imaging status, the Review screen displays the images of the current exam, and the default selected image is the one displayed on the preview main screen.
- Info
  - Click to enter the Animal Info screen, you can review or edit the currently-selected animal information.
- Report
  - Click to review or edit the currently-selected animal report.
- Image operations
  - [Select All]: click to select all images in the thumbnail window.
  - [Deselect All]: after clicking the [Select All], the button changes into [Deselect All], you can cancel all the selections by clicking [Deselect All].

[Send To]: click to send the selected image to other location, DICOM server, printer and etc.





[Delete]: click to delete the selected image.

- Layout:  
You can select the layout of the Review screen among three selections: 1×1, 2×2 and 4×4.
- Switching operations:  
[New Exam]: click to create a new exam for the selected animal and open the Animal Info screen.  
[Activate Exam]: click to activate the currently selected exam and enter the image scanning screen; it grays out if the current animal cannot be activated.  
[Open]: click to open the selected image.  
[iStation]: click to enter the iStation screen.  
[Exit]: click to exit the Review status, and return to the main screen.

### 16.2.8.2 To analyze images

For the image analysis, you can view, zoom, perform post processing and measurements, add comments and perform cine (multi-frame) review for a stored image. The operation steps are the same as those for real-time scanning; please refer to relevant sections for details.

- To enter image analysis:
  - In the image scanning or freeze status, double-click a thumbnail stored in this exam to enter the image analysis status; or
  - In the Review status, select a thumbnail and click [Open] or directly double-click the selected thumbnail to open the image.
- To exit the image analysis:
  - Press <Freeze> to exit and enter the real-time scanning status.
  - Press <Review> to exit from the image analysis to the Review status.
  - If the image under analyzing belongs to the current exam, click [Return] on the lower-right corner of the screen to exit image analysis and enter real-time scanning; if the image under analyzing does not belong to the current exam, the system will enter the previous screen before entering image analysis after you click [Return](e.g. iStation screen or Review screen).

In image analysis status, the selected image is open on the screen, and the thumbnails of the same exam are displayed on the Thumbnail area, you can click   to turn pages, click  to delete or click  to send a selected image.

### 16.2.9 iVision

iVision function is used for demonstration of the images stored. Image files are played according to file names one by one (including the image of system-relevant and PC-compatible format).

To perform image demonstration:

1. Enter iVision screen:  
Click [iVision] on the Other menu; or press the user-defined key for iVision on the control panel (setting path: [Setup]→[System Preset]→[Key Config]).
2. Add the contents to be played and select the demo mode.

3. Select an item in the list, and click [Start] to begin the demonstration.
4. Click [Exit] or press <ESC> to exit the iVision status.

The iVision screen is shown as follows:

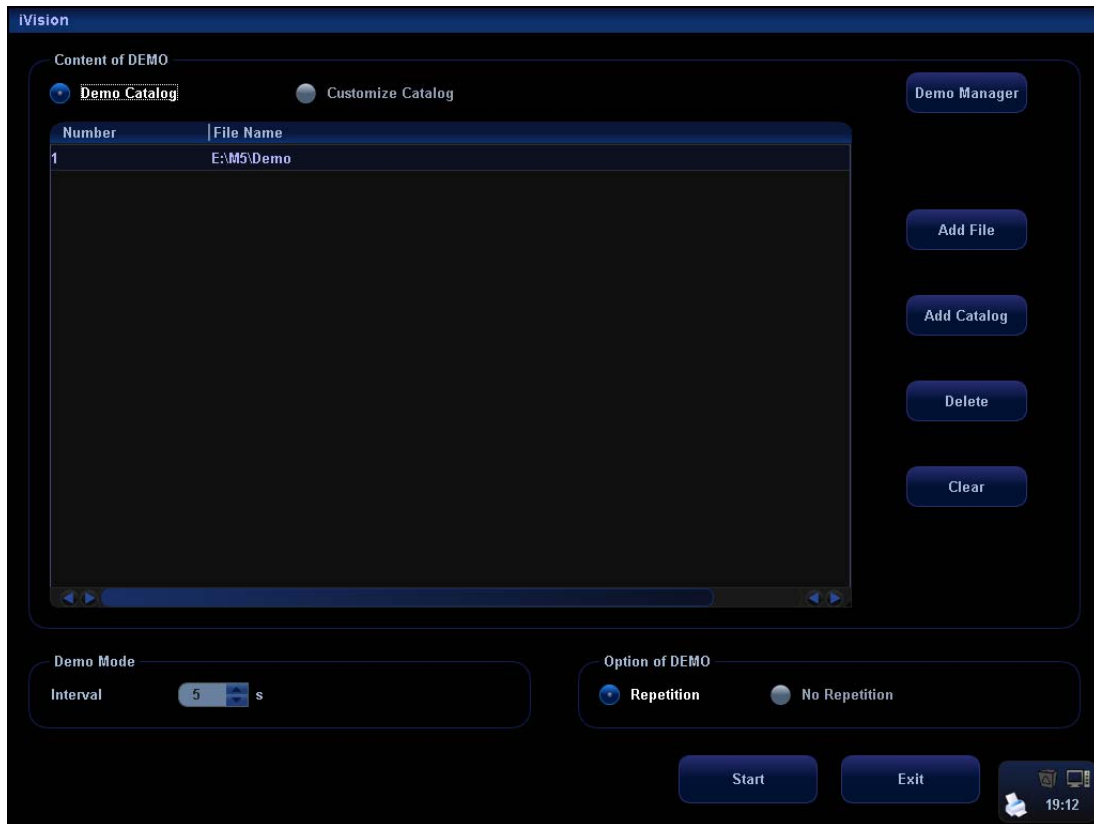

#### ■ Demonstration item

The demonstration items are the image files in the formats that the system supports. You can add the exam data in animal database or system supported image files and folders to demonstration list. For files and folders in demonstration list, the images in the directory and subdirectory are played one by one, and the system will automatically jump over the files that can't be opened.

#### ■ Demonstration item

There are two kinds of catalogs: Demo Catalog and Customize Catalog.

- Demo Catalog: demo catalog is the folder in hard disk (E disc), where the factory DEMO is stored. The system plays the images in this folder when performs demonstration.

The system supports import, delete or clear the data in demo catalog.

Click [Demo Manager] to operate:

**>**: to import data to demo catalog.

**<**: to delete the selected data.

**<<**: to delete all data.

- Customize Catalog: what saved here is the catalog of the displayed image. The system plays the images in the catalog when performs demonstration.

Operate the catalog by the buttons on the right:

[Add File]: to add files to the file list.

[Add Catalog]: to add catalog to the file list.

[Delete]: to delete the selected file or catalog in the file list.

[Clear]: to clear all the files or catalogs in the file list.

- Demonstration mode

Interval: refer to the interval time for demonstration, the adjusting range is 1~500s.

- Option of Demo

You can choose whether to repeat the demonstration or exit after a demonstration is completed.

## 16.2.10 Sending Image File

- On the image screen, select a stored image thumbnail, click  (Send To) on the lower right corner of the screen, the image can be sent to the external device, VCD/DVD recorder, DICOM storage server, DICOM print server, system connected printer or network storage and etc.
- In the iStation or Review screen, click [Send To] to send the selected image to the external devices.

See the figure below.

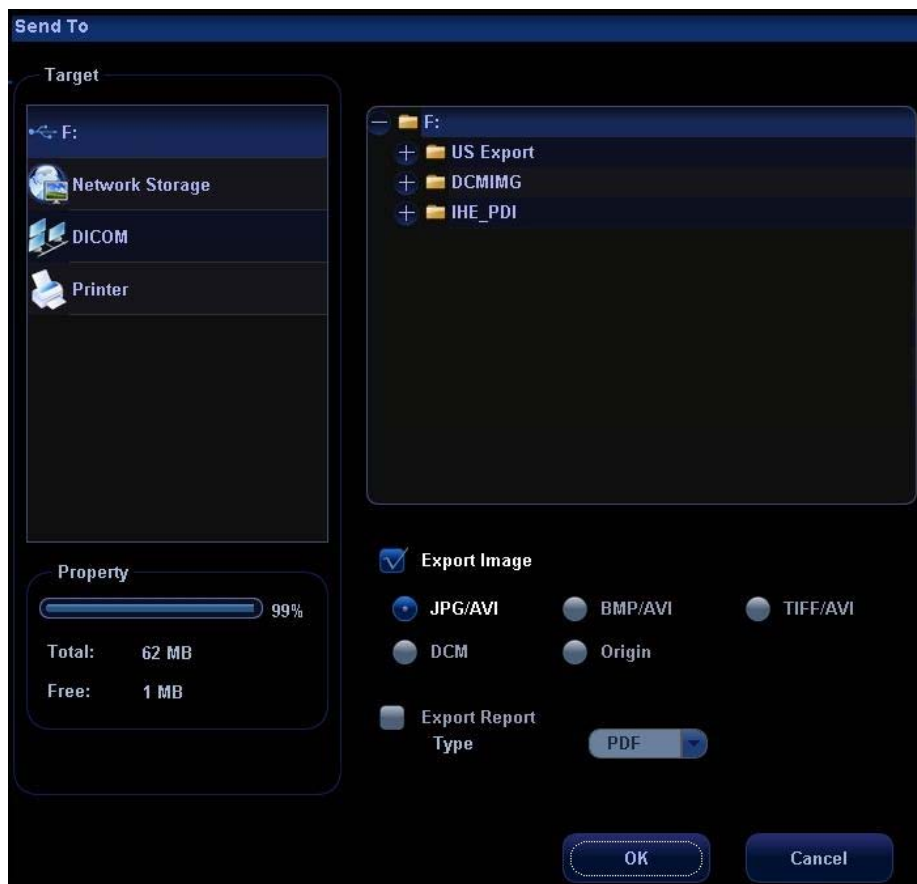

- For external memory devices (e.g. USB memory devices , DVD-RW/DVD+RW or network storage server):
  - (1) PC format transfer: JPG/ AVI, BMP/ AVI, TIFF/ AVI. Where a single-frame image is exported as JPG, TIFF or BMP, and the cine file exported as AVI.
  - (2) DCM format transfer: DCM (including single-frame DCM and multi-frame DCM).

- (3) You can also select to export report in RTF/PDF format.
- For DICOM Storage or Print server, select the DICOM Storage or Print server.
  - For a video printer, send images to the video printer connected with the system. For a graph/ text printer, send the images to the default graph/ text printer.

## 16.3 Report Management

### ■ Report storage:

The exam reports are stored under the directory of the exam of the animal.

### ■ Importing, exporting and sending a report

In the iStation screen, select animal data, click [Restore] or [Backup] to import or export animal information, images and reports from or to an external memory device. See the following figure:

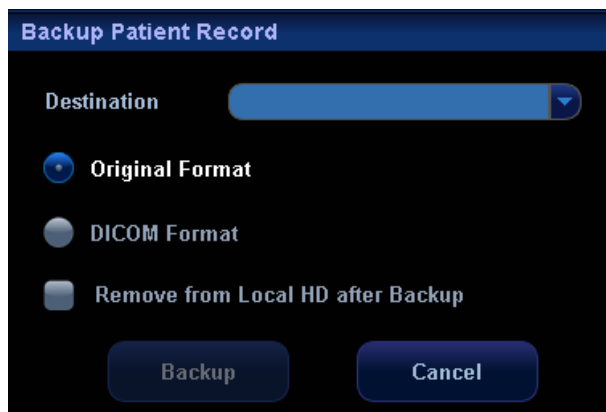

In the [iStation] or [Review] screen, click [Send To] to send animal data to an external memory device; and you can choose if reports are exported with images for external devices. See the figure below.



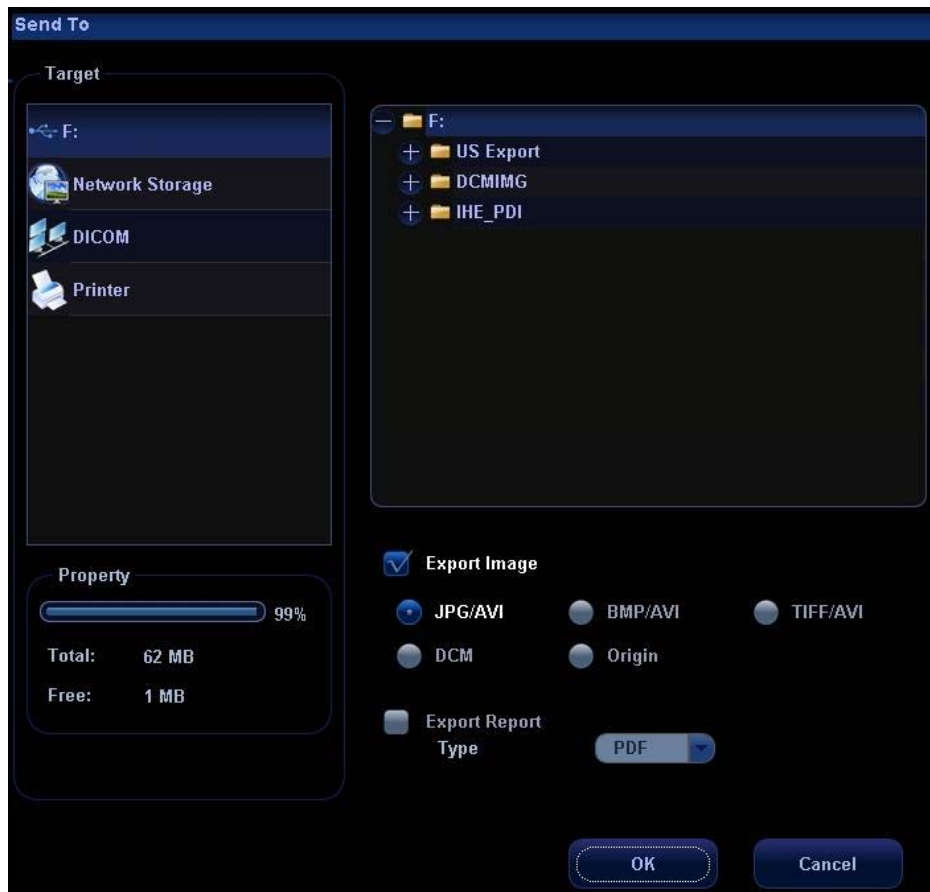

Check [Export Report]. Select report format in the drop-down list (RTF or PDF). Click [OK] to export the report to destination.

- Printing report  
Use a connected graph/text printer to print a report.

## 16.4 Data Management (iStation)

The animal data include basic animal information, exam information, image files and reports. You can search, view, backup, send, restore or delete animal data in iStation.

- To enter iStation:
  - a) Press the <iStation> key on the control panel; or
  - b) Click the [iStation] button in the Animal Info screen; or
  - c) Click the [iStation] button in the Review screen.



### 16.4.1 Viewing Animal Information

- Data Source
  - Select the data source of animal data, the system animal database is default.
- Animal
  - Display animal information, exam mode, number of images and cines, exam state, backed up or not.
- Info
  - Select an exam of an animal, click [Info] on the right side to display the animal information of this exam.
- Report
  - After you select an exam of an animal, click [Report] to view the report of this exam for this animal.
- Review
  - Select an exam of an animal, click [Review] to enter Review screen.
- Select All/Deselect All
  - Click [Select All] to select all the animal data listed. Then the button changes into [Deselect All], you can cancel all the selections by clicking [Deselect All].

## 16.4.2 Searching a Patient

- (1) Select the data source.
- (2) Set search conditions of Name, ID, DOB, and Exam Date in the "Item" drop-down list.
- (3) Enter the keyword in accordance with the "Item" selected, and the system searches and displays the results in the animal list.
- (4) When you select an animal in the animal list, the images of this animal will be displayed at the bottom of the screen.

### Tips:

- When you clear the keyword, enter other keyword or cancel the selection "Find in results", the system will refresh the searched results.
- Click [Reset], the system will clear the information you entered in Keyword, and all the recorded animal information will be listed out.
- Select "Find in results", the system will do searching based on the last searched results.

## 16.4.3 Data Management

### ■ Send To

The system supports to send data to external memory devices or print.

- The [Send To] button on the right side of the animal list is used to send exam data or images of the selected exam.
- The [Send To] button on the right side of the thumbnail area below the animal list is used for sending selected images.
  - Send animal exam data to USB devices, DVD-RW/DVD+RW drive and network storage.
  - Send images to USB devices, DVD-RW/DVD+RW drive, DICOM storage server, DICOM printer, video printer, text/ graph printer and network storage.
  - Send images with report to USB devices, DVD-RW/DVD+RW drive and network storage.
  - Format transfer is available when sending images to USB devices, DVD-RW/DVD+RW or network storage. (Please refer to "16.2.10 Sending Image File" for details.)
  - Press <Shift> on the control panel to select more than one exam or image at one time.

### ■ Delete

To delete the selected animal or exam data, click the [Delete] button on the right side of the animal list. However, you cannot delete animal data being printed, exported or sent, or delete the current exam.

- The [Delete] button on the right side of the animal list is used to delete exam data of the selected exam.
- The [Delete] button on the right side of the thumbnail area below the animal list is used for deleting selected images.

### ■ Recycle bin

The recycle bin is used to store the deleted animal data, exam data and images (time lasts from deleting to system is powered off). The system supports recovery of those

data from the recycle bin. Tips: The recycle bin will be cleared after the system is powered off.

To recover the deleted animal data, click  at the lower right corner of the screen (when the button is gray, the operation is unavailable) to enter the Recycle Bin screen.

(1) Select items to be recovered in the list.

(2) Select operations:

- Click [Restore Items] to restore the item back to iStation.
- Click [Delete] to delete the item permanently, and the item can never be restored again.
- Click [Restore All Items] to restore all the items back to iStation.
- Click [Empty Recycle Bin] to empty the recycle bin and all items can never be restored again.

Click [Exit] to exit Recycle Bin screen and return to iStation.

#### ■ Backup/ Restore

You can back up the selected animal data to the system-supported media in order to view it on PC, or restore the animal data to the system from an external media.

[Backup]: click to export the selected animal data to the system-supported media.

[Restore]: click to import the animal data from an external media. If no external data source is connected, then the button is unavailable.

## 16.4.4 Examinations

#### ■ New Exam:

After you select an animal data or exam in the iStation screen, click the [New Exam] to enter the Animal Info screen, where you can select a new exam mode and click [OK] to begin a new exam.

#### ■ Activate exam

After you select an exam, which has been performed within 24 hours, click [Activate Exam] to activate the exam and load the basic animal information and measurement data to continue the exam.

If you want to select an animal data in an external memory database, you have to first allow the system to load the animal data to the system's animal database.

#### ■ Continue Exam

Select an exam that is paused within 24 hours, click [Continue Exam] to activate the exam and load the basic animal information and measurement data to continue the exam.

If you want to select an animal data in an external memory database, you have to first allow the system to load the animal data to the system's animal database.

#### ■ Query/ Retrieve

The Query/ Retrieve function is to query and get the animal exam record from a specified server. (For details, please refer to DICOM chapter.)

## 16.5 Network Storage

Network storage is used to save image files and measurement reports to the remote PC server.

### 16.5.1 Network Storage Setting

Open “[Setup]→[Network Preset]→[Network Storage]” to perform network storage setting.

**Network Storage**

Configure Service

Service Name

Destination Device  IP Address

User Name  Password

Shared Dir

Service List

	Service Name	Destination Device	IP Address	Shared Dir	Default
1	me	i	192.168.4.89	M7	N

19:14

Name	Description
Service Name	Name of the device, cannot be empty
Destination Device	Name of the device, cannot be empty
IP Address	IP address of the network service device, cannot be empty
Ping	You can ping other machines to verify connection after entering the correct IP address. Also you can check the connection of the already added server in the list.
User Name:	User name for entering the shared PC server, which is decided by the server
Password	Password for entering the shared PC server, which is decided by the server

Shared Dir	Shared folder directory, cannot be empty
Review	To enter the Net Disk Browse screen to set the shared folder directory. And if the user name or the password is incorrect, the server cannot be entered.
Add	Click it to add the Network service to the service list.
Cancel	Click to cancel parameter setting
Update	To save the changed parameters.
To set default server	To set as the default server for network storage
Delete	Click to delete the selected service in the service list.
Exit	Click to exit the screen.

■ Add a network service:

1. Set the network server properties as described above.
2. Click [Add] to add the service to the Service list.
3. Select the added service in the service list, you can set it as default or delete it.

■ Modify a network service:

1. Select the service to be updated in the service list.
2. You can see properties in the Configure Service area.
3. Modify the parameters and click [Update] to update setting.

Tips: in order to make network storage function normally, setting of the sharing folder of the PC server in advance is a must, e.g. destination, user name and password should be confirmed at first.

## 16.5.2 Network Storage

1. Enter iStation; select one (or more than one) animal data or image in the local data source.
2. Click [Send To].
3. Select [Network Storage] in the Send To dialogue box, and select the PC server of the right side.
4. Select PC transfer format and check if to send report.
5. Click [OK] to start sending.

■ User-defined key for network storage

- Send Image to Network Storage: to send image (JPG format) to the default network server.
- Send AVI Cine to Network Storage: to send image (AVI format) to the default network server.

## 16.6 Print Task Management

You can manage the pending print tasks, to continue or cancel.

After the printer is successfully connected and print task is undergoing, click the printer icon  in the lower right corner of the screen to open the Print Task Manager screen.



Information of all print tasks is displayed in the list, including ID, name, status (being printing or suspended), and submit time.

- To delete a print task  
Select the print task in the list and click [Delete].
- To restart a print task after it is suspended  
When the printer ran out of ink or paper, tasks in print list will be paused. Click [Restart] to restart the paused print task.

## 16.7 Backing Up and Erasing Files through DVD Drive

The system supports DVD-RW/DVD+RW drive to write data in CD/DVD and to read data from CD/DVD in PC.



The system supports the following media: CD-R, CD-RW, DVD+R, DVD+RW, DVD-R and DVD-RW.

The DVD-RW drive is connected to the system through a USB port. After you put a

CD/DVD in the tray, the  symbol will appear in the lower right corner of the screen.

The DVD-RW drive can write the files in the format of ISO or UDF, and the setting path is [Setup] → [System Preset] → [General] → “Storage” → “File System Type”.

- To write data to a CD/DVD:
  1. Put a CD/DVD in the tray.
  2. Select the data to be backed up, click [Send To] or [Export] button in the screen (such as the [iStation] screen). Select the target drive in the Send To or Back Up Record dialogue box.

3. Click [OK] or [Export] button in the file-exporting screen.
4. After the writing process is completed, click  to pop up the Disc Option dialogue box, and select [Eject] to eject the CD/DVD.
  - To erase data from a CD/DVD
    1. Double-click the  symbol to pop up the Disc Option screen, as shown in the figure below.
    2. Click [Erase] to erase data from a CD/DVD.
    3. After the erasing process is completed, click [Eject] in the Disc Option dialogue box.

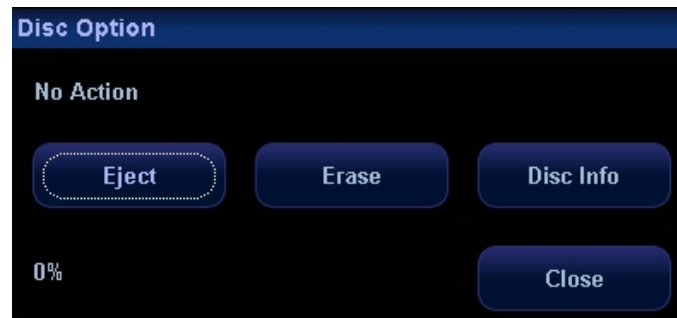

Tips:



- Writing data using “Send To” supports PC format transfer function, while CD/DVD written by “Backup” supports only system-relevant formats.
- The  symbol indicates that the input CD/DVD is damaged or with data of wrong format.

**⚠ CAUTION:**

1. During the backup process, if a CD/DVD is forcibly taken out or you perform other operations, the backup process will fail or the system may malfunction.
2. You must press [Eject Disc] button to take out the DVD disk before disconnecting the DVD-writer or turning off the system. Otherwise you may damage the DVD disk or lose data.

**NOTE:** Directly removing a DVD-RW/DVD+RW drive may result in the damage of drive and/or the system, please refer to 5.9 Connecting/Removing a USB Memory Device for disconnection.

## 16.8 Task manager

Click  or  at the lower right corner of the screen to pop up the following dialogue box:



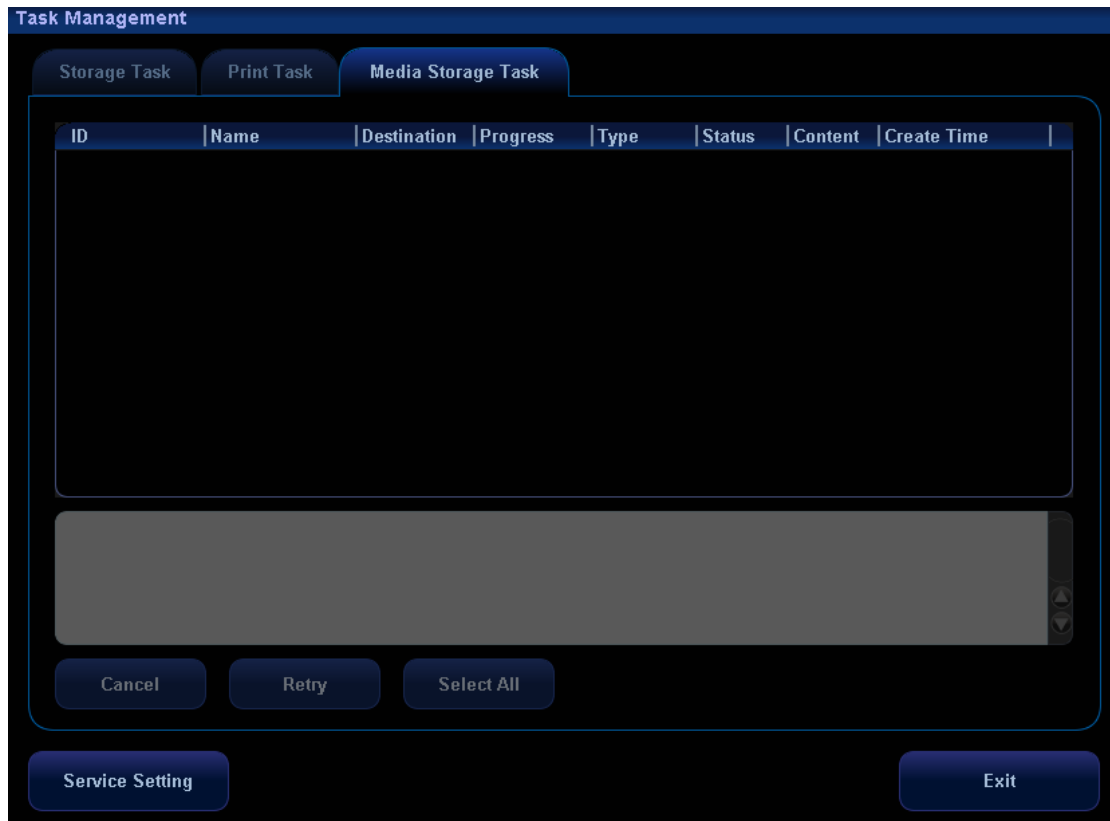

The system supports three types of task management:

- Storage Task: displays the DICOM storage task.
- Print Task: displays the DICOM print task.
- Media Storage Task:
  - DICOM media storage task(including disc and USB devices)
  - Backup task (system-relevant format): select the exam to be backed up in iStation and click [Backup].
  - Send to external devices (including disc and USB devices): select exam data or images in iStation or Review screen, click [Send To]
  - Network storage task

In the Task Management dialogue box, animal ID, name, destination, progress, type, contents and task created time are displayed.

You can do the following operations:

- Click [Cancel] to cancel the selected task.
- Click [Retry] to retry the failed task.
- Click [Select All] to select all the tasks.
- Task Status

Select the undergoing task, the system will display its detailed status information or error information.

When there is/are task(s) undergoing, the task management icon displays as , you can click the icon to check the process.

When there is/are task(s) failed, the task management icon displays as , you can click the icon to check the failure reason.

When the task management icon displays as , it means no task is undergoing or failure.

## 16.9 Reviewing the AVI Files

To review the AVI files, which are stored in the ultrasound system, in the environment of PowerPoint in a PC, you will perform the following operations to ensure the quality of images:

On the PowerPoint screen, select [Media Player], and then select: View → Toolbar → Control Toolbox → Other Controls → Media Player. To set up the file, you need to: click the right button of the mouse on the control → Property → User-defined → Review.

## 16.10 Admin

### 16.10.1 Access Setting

There are two kinds of users: the system administrator and operator. The system administrator can manage other operators, and view all animal data, such as animal information, image and report, etc. The system administrator can view all animal data, such as animal information, image and report, etc. The operator can only view the exam information saved in the system and operated by him or herself, such as animal information, image and report, etc. The operator cannot view the exam data operated by others.

Emergency operators are general ones; they can enter the system without entering password. But they can't modify or delete the password.

### 16.10.2 Setting Access Control

The system administrator can preset the access control, that is, if an operator has the right to access to the data in the system.

The access control only can be set by the system administrator.

Setting access control:

1. Open the "Admin" page through the path: [Setup]→[System Preset]→[Admin].
2. If  **Enable User Account Control** is selected, you need to have the authority before accessing the data. If unselected, you can access all the data without the authority.

### 16.10.3 System Login

If access control has been set by the system administrator, you can access the data in the system only after you log on the system.

You need to enter user name and password in the following cases:

- Before entering the system
- Changing user

As long as the system is in the working status, you can enter the above screens without entering user name and password repeatedly.

- Log on the system:
  - a) If the system requires you to log on the system before you access the data, you can see the following dialogue box.

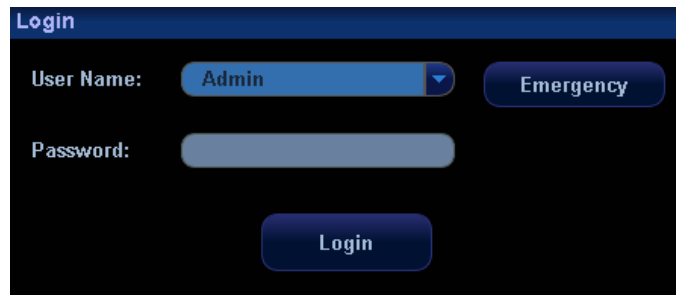

- b) Select the user name in the drop-down list of User Name.
- c) Enter password and click [Login].

Tips: For emergency users, click [Emergency] directly to log on.

- To change user:

- (1) To log out the current user and change to another user, click  at the lower right corner of the screen to pop up the following dialogue box:

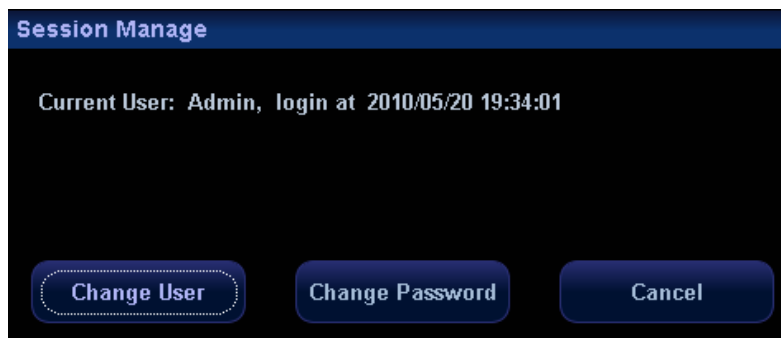

- (2) Click [Change User] to pop up the Login dialogue box.
- (3) Enter the user name and password in the field box.

## 16.10.4 Add/ Delete a User

The system administrator can add and delete a user, while the operator can't.

### 16.10.4.1 Add a User

Premise: you must log on the system as the system administrator. If not logged on, the system will prompt denied permission.

1. Open the "Admin" page through the path: [Setup]→[System Preset]→[Admin]. See the figure below.

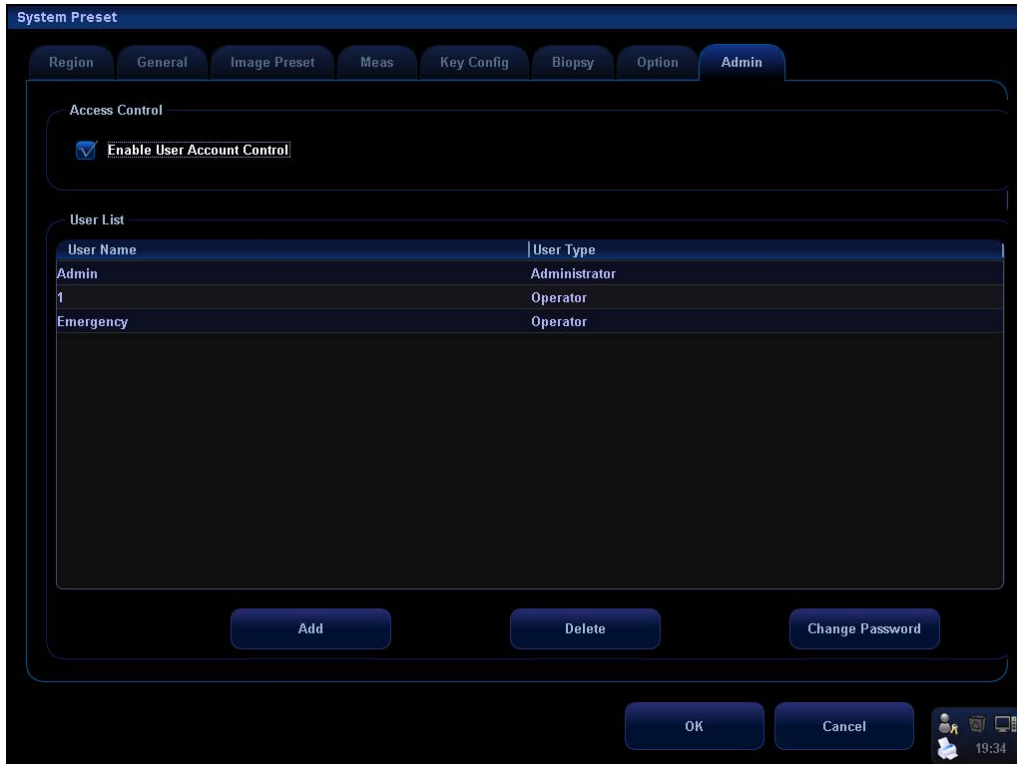

- Click [Add] to enter the following page.

- Enter the user name (you are not allowed to enter the same name or modify the name already exist).
- Enter the password and the confirm password (the password is consist of 6-16 characters)
- Set the user role in the drop-down list: administrator or operator.
- Click [OK] to confirm the setting and exit the dialogue box, then the new user will appear on the User List.

#### 16.10.4.2 Delete a User

Premise: you must log on the system as the system administrator. If not logged on, the system will prompt denied permission.

- Open the "Admin" page through the path: [Setup]→[System Preset]→[Admin].

2. Select the user to be deleted in the User List (Emergency user can't be deleted), click [Delete] to delete the selected user.

## 16.10.5 Modify Password

The system administrator can modify password of all users. The administrator password by factory is empty; you can set the password for it. The operator can only modify his/her own password.

To modify the password, the user has to log on the system first.

There are two ways to modify password: modify it on "Admin" page or on "Session Manage" dialogue box.

■ "Admin" page (administrator can modify the password)

- (1) Open the "Admin" page through the path: [Setup]→[System Preset]→[Admin].
- (2) Select the user name to be modified (except emergency operator) in User List, click [Change Password] to open the dialogue box (see the figure below).

- (3) Enter new password and confirm password, then click [OK].

■ Session Manage page (general operator and administrator can modify the password).

When the user has logged on the system, you can see  at the lower right corner of the screen.

- (1) Click  at the lower right corner to pop up the Session Manage dialogue box, on which you can see the current user's information.
- (2) If you want to modify the current password, click [Change Password] to pop up the Change Password dialogue box.

- (3) Enter the previous and the new password in the dialogue box.
- (4) Click [OK] to exit.

# 17 Parameter Setup

---

The Setup function is designed to set the configuration parameters of operating the system and maintain user workflow preferences. User and system setups are stored to the hard drive, and should be backed up to CD or USB memory devices.

<b>⚠ CAUTION:</b>	<b>When the setup data is changed, be sure to save the preferences according to the methods described in this chapter. Mindray is not responsible for the loss of the setup data.</b>
-------------------	---

## 17.1 Entering / Exiting Setup

To enter the setup status:

- Press the [Setup] key on the control panel; or
- Move the cursor onto the menu title (of image menu, ECG menu or biopsy menu), other selections pop up, navigate the cursor to the “Other” item and press [Set]. Select [Setup] in the [Other] menu to enter the [Setup] menu.



To exit the setup status:

Selecting [Return] on the menu will close the Setup menu, and save your changes.

## 17.2 System Setup

The system setup contains several pages, i.e., Region, General, Image Preset, Meas, OB, Key Config, Biopsy and Option.

To confirm the modified parameters, click [OK]. To cancel the modified parameters, click [Cancel]. Click the [Load Factory] button to restore the current page to the factory settings. The content of each page is described as follows.

- **Region**

The Region page is to set up hospital information, logo setting, language, time zone, time format, date format, system date and system time. Enter text for the hospital name. Other fields are populated with options or drop down menus.

- **General**

The General page is divided into several areas, i.e., Animal Info, Exam Setup, Animal Management, Storage, System Dormancy, ABC, Input Setting and Display.

- **Image Parameter Preset**

The Image Preset page is divided into Reset Config and Image.

- **Meas**

The Measurement page is used for setup of

- a) Measure Ruler
- b) Measure Result
- c) Measurement-relevant Units
- d) ICA/CCA

- **OB**

The OB Setup page is used for setup of

- a) EFW
- b) GA Calculate Formula

- **Key Config**

You can define [Print] key, [Save] key and [F1] through [F4] keys and Footswitch on the control panel in this page. In addition, you can set [Key Lightness], [Key Volume] and [Trackball Speed].

User-defined key setting

- a) Click to select the desired key in the Key Function column at the left side of the page.
- b) Click to select a function in Function area. You can see the functions selected at the right side of the select key.
- c) Click [OK] to complete function setting.

In Function area, the functions of user-defined keys can be divided into three categories: Output, Advanced Features and Other:

Type	Function	Description
Output	Analog Color Video Print (P1)	Used for analog color video printer printing

Type	Function	Description
	Analog B / W Video Print (P2)	Used for analog B/W video printer printing
	Digital Color Video Print (P3)	Used for digital color printer printing
	Digital B/W Video Print (P4)	Used for digital B/W video printer printing
	Standard Print (P5)	Used for digital graph/text print
	Save Single-frame Image to Local Disk	To save a single frame image to the system in the system-relevant format.
	Save Cine to Local	To save a cine to the system in the system-relevant format.
	Save Full Screen Image to Local	To save a full screen image to the system in the format of JPG or BMP.
	Save Image to USB disk (S1)	To store single-frame image to USB flash drive
	Save AVI Cine to USB disk (S2)	To save AVI cine to USB disk
	Save Image to Network Storage	To save single frame Image to network server
	Send AVI Cine to Network Storage	To save multi-frame Image to network server in AVI format.
	Send Single Frame Image to DICOM Printer	To send single image to DICOM printer
	Save Single Frame Image to DICOM Server	To save single frame image to DICOM server
	Save Multi-frame Image to DICOM Server	To save multi-frame image to DICOM server
Advanced Features	Smart3D	Enter/ Exit Smart3D
	Trapezoid	To turn on the trapezoid function.
	iScape	To enter/exit iScape imaging mode.
	Free Xros M	To enter/ exit Free Xros M mode.
	Colorize	To turn on the colorize function.
	Auto Calc	To enter/exit auto calculation.
	Save Image Para	To save image parameters
Other	Display Biopsy Line	Press to show or hide the biopsy guide line.
	Record	To enter or exit the video record status.
	Video	To enter or exit the video replay status.
	Set Home	To set home of comments.
	Home	To make the cursor return to the home position.
	ABC Display	To display/hide the comments.



Type	Function	Description
	Erase All Text	To delete all comments on the screen.
	Delete word	To delete a word in a comment.
	iZoom	To enter/ exit full-screen zoom status.
	iVision	To enter/ exit iVision.

### To define footswitch:

- 1 Select [Footswitch] tab to open the [Footswitch] page. See the figure below.

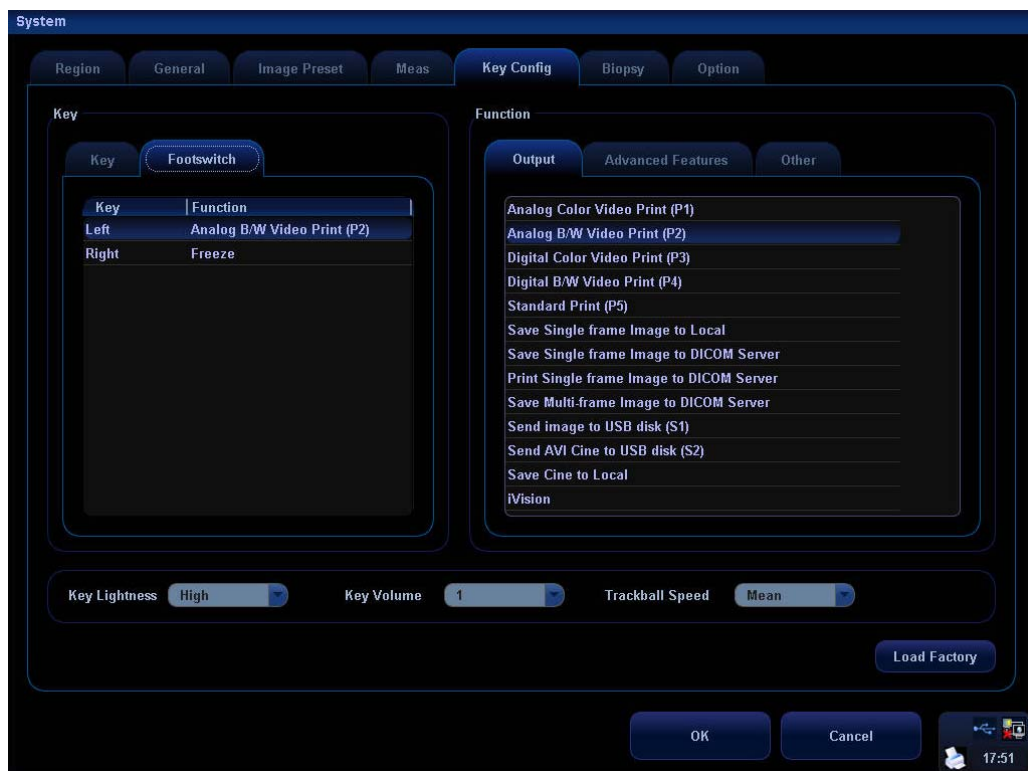

- 2 Click to select [Left] or [Right].
- 3 Click to select a function in the [Output], [Advanced Features], [Measurement] or [Other] page.
- 4 Click [OK].

#### ■ Biopsy

The Biopsy page is used for setup of the default bracket for a transducer and the biopsy guide line dot type or to set if the guide line is visible.

#### ■ Option

The Option page is used to install or uninstall the optional functions.

Click [Install] to begin the installation of a disabled option.

Click [Uninstall] to begin the un-installation of an already installed option.

For some of the options, it can be provided for use for a certain period before you buy it,

click [Trial] to do this.

- Admin

Please refer to “16.10 Admin” for details.

## 17.3 Exam Mode Preset

Refer to “9.3 Setting Exam Types”.

## 17.4 Image Parameter Preset

Refer to “10.4 Image Parameter Preset”.

## 17.5 Comment Preset

Refer to “14.7 Comment Preset”.

## 17.6 Body Mark Preset

Refer to “15.8 Body Mark Preset”.

## 17.7 Measurement Preset

Refer to Measurement Preset in the Operator’s Manual [Advanced Volume].

## 17.8 Soft-Key and Menu Preset

You can preset parameter items in image modes for all types of transducers, in the menu (displayed at the bottom of the screen) and the menu (displayed on the upper left side of the screen), as well as parameter items for 3D capture, 3D review, PW mark, Reset ROI. In addition, you can preset parameter items in freeze status and cine review status.

- Open the [Soft-Key and Menu Preset] screen

To open the [Soft-Key and Menu Preset] screen, press [Setup] and select Key and Menu Preset. The default is the currently-used transducer in the current image mode.

- Preset Operations

Since the preset operations are the same for different image modes and statuses, the following case (linear transducers in real time B mode) is taken as an example.

## 1. Parameter Items Displayed in Soft Menu

The system has factory settings for parameter items displayed in soft menu; however, you can preset or customize them according to your preferences.

To preset parameter items in soft menu, enter [Image Params] page in the [Key and Menu Preset] screen, select Probe Type as Linear and select Image Mode as B. Open the [Softkey] page on the right side. See the figure below.



Available Items on the left side: You can select these items and move them to the Softkey page the right side.

Items in the Softkey page on the right side: These items will display in the menu.

- Delete items from the soft menu

To delete one item: Move the cursor onto an item in Softkey page on the right side, which is highlighted, click [Set], and then move the cursor onto  and click [Set]. This item appears in the Available Items box and will be deleted from the soft menu.

To delete all items: Move the cursor onto  and click [Set]. All items appear in the Available Items box and will be deleted from the soft menu.

- Add items to the soft menu

To add an item: Move the cursor onto an item and click [Set], and it is highlighted. Move the cursor onto  and click [Set], and the item appears in a previously blank button in the Softkey page. In turn, multiple items will fill the blank buttons in the order of left to right and up to down. If needed, the system can automatically add a new line of blank buttons, and at the same time add the new items; you can click [Add Blank Line] or [Del Blank Line] to add or delete a line of buttons.

- Change position of an item in the Softkey page



You can click [Up], [Down], [Left] or [Right] buttons to change position of an item. For example, to move an item down,

- Select an item,
- Click [Down]
- The item will move down, and the item below it will move up.

## 2. Parameter Items Displayed in Image Menu

To preset parameter items in image menu, enter [Image Params] page in the [Key and Menu Preset] screen, select Probe Type as Linear and select Image Mode as B. Open the Menu page on the right side. See the figure below.

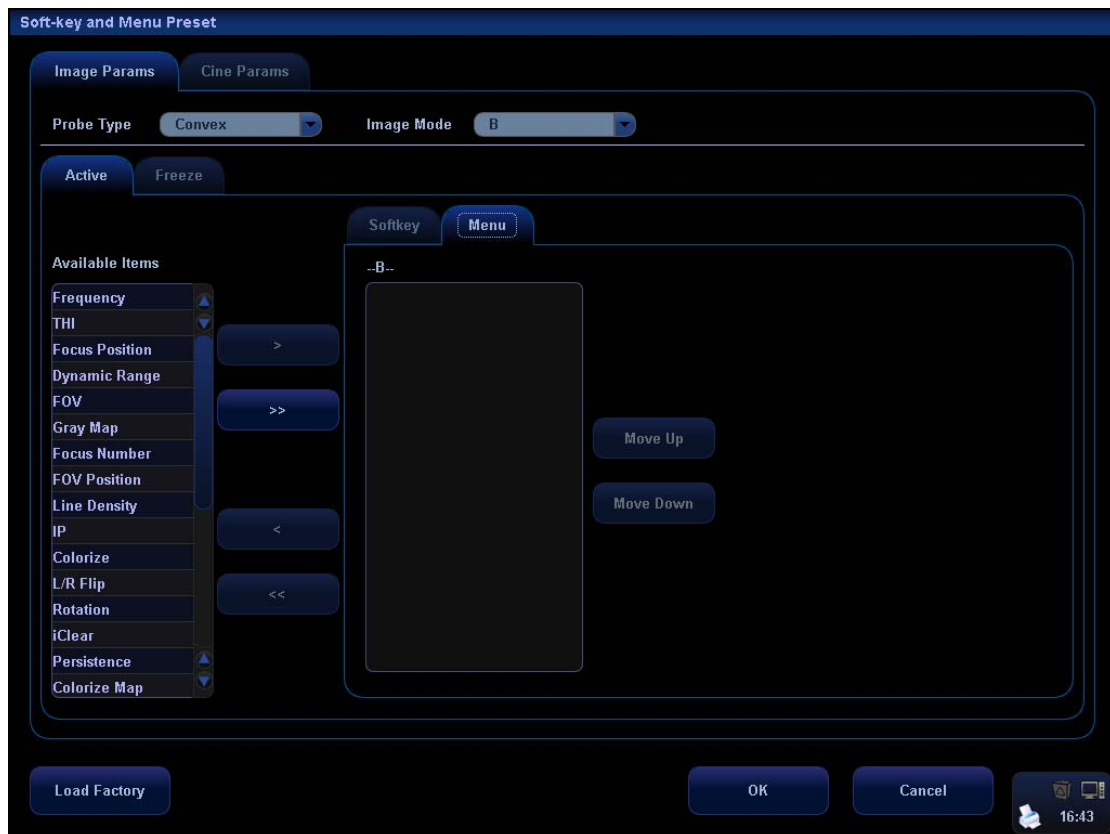

- Add or delete an item

To add an item to the image menu, select an item in the Available Items box and click



. This item will display in the image menu.

To delete an item from the image menu, select an item on the right side box and click



. This item will disappear from the image menu.

To delete all items from the image menu, directly click . All items will disappear from the image menu.

- Change position of an item

To change position of an item, select the item in the right side box and click [Move Up] or [Move Down].

- Exit the [Soft-Key and Menu Preset] screen

Click [OK] to confirm the preset operations and exit the screen;

Click [Cancel] to cancel the preset operations and exit the screen.

## 17.9 Peripheral Setup

Click [Setup] key to show the Setup menu, and select [Peripheral] in the Setup menu to open the [Peripheral Config] screen. The [Peripheral Config] screen is used to set up printer, recorder and I/O configuration.

### ■ Set Up Printer

The settings of a printer include: set a printer, add a printer, change printer attribute, set paper size and direction. See the figure below.

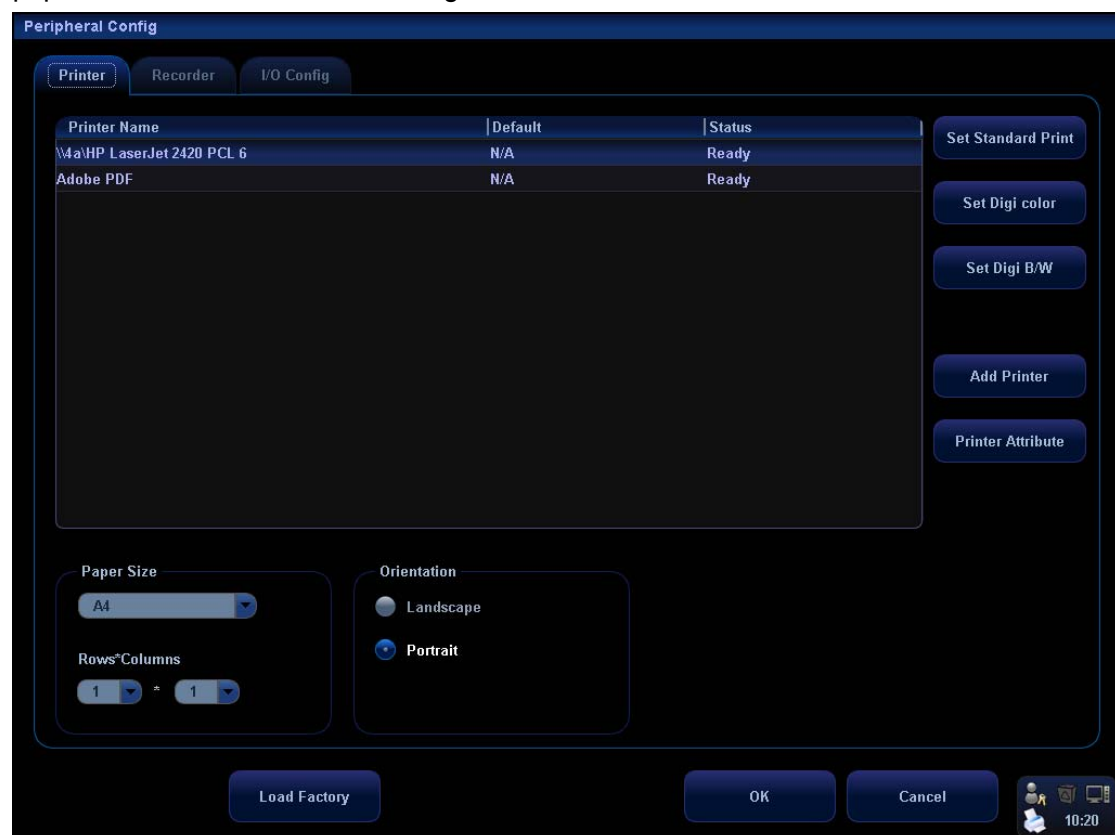

#### 1. Add a printer

For the digital video printers aforementioned in the Chapter 3.4, you do not need to install them.

For the printers not mentioned, you need to install them. Click [Add Printer] to open the screen and select the printer driver (with postfix name INF) in the specified location and click [OK]. After the installation is complete, you need to set the printer in the [Peripheral Config] screen.

#### 2. Set a Printer

To set a default graph / text printer, select a graph / text printer in the list and click [Set Graph/Text].

To set a video printer, select a video printer in the list and click [Set Digi Color] or [Set Digi B/W].

Note: If you use the user-defined key to print, the user-defined printer type shall be consistent with that of the default printer.

Click [Printer Attribute] to see the printer attributes, and you can update printer driver here.

### 3. Set paper

Paper size: select among A4, B5, Letter, and Unknown in the drop-down list.

Rows\*Columns: to set format of the images on the paper.

Direction: select between Landscape and Portrait.

#### ■ Set Up Recorder

In the [Peripheral Config] screen, click Recorder to open the Recorder page. The system supports DVR and VCR. See the figure below.

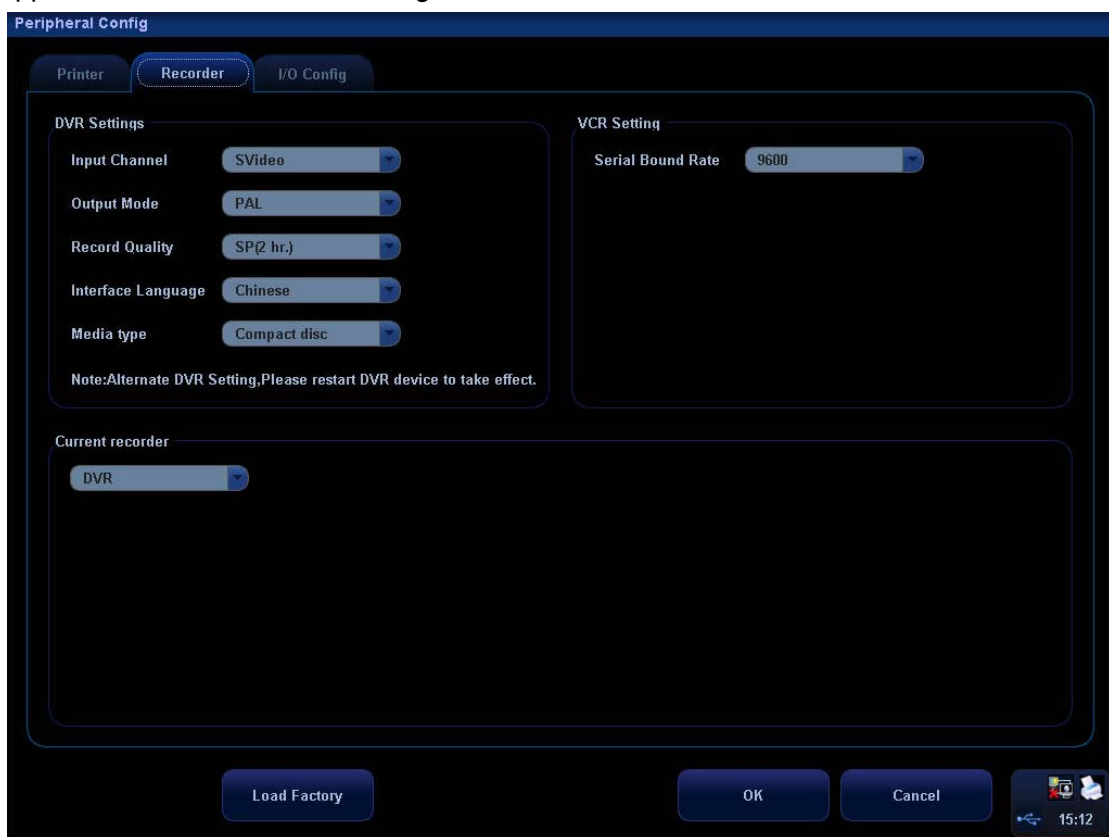

DVR Settings	
Settings	Available Selections
Input Channel	Svideo CVBS
Output Mode	PAL NTSC
Record Quality	HQ (1 hr.): high quality; one hour recorded for a disc SP (2 hr.): standard play; two hours recorded for a disc EP (4 hr.): extended play, equivalent to VHS; four hours recorded for a disc LP (6 hr.): long play, equivalent to VHS; six hours recorded for a disc
Interface Language	Chinese English
Media Type	Compact disc Hard disc

VCR Settings: serial baud rate, 9600Hz by default.

Current recorder: select DVR or VCR as the current recorder, or select None for no connection of a recorder.

#### ■ I/O Config

In the [Peripheral Config] screen, click I/O Config to open the I/O Config page. You can set up video input port, video output size and mode, as well as color temperature, brightness and contrast for display.

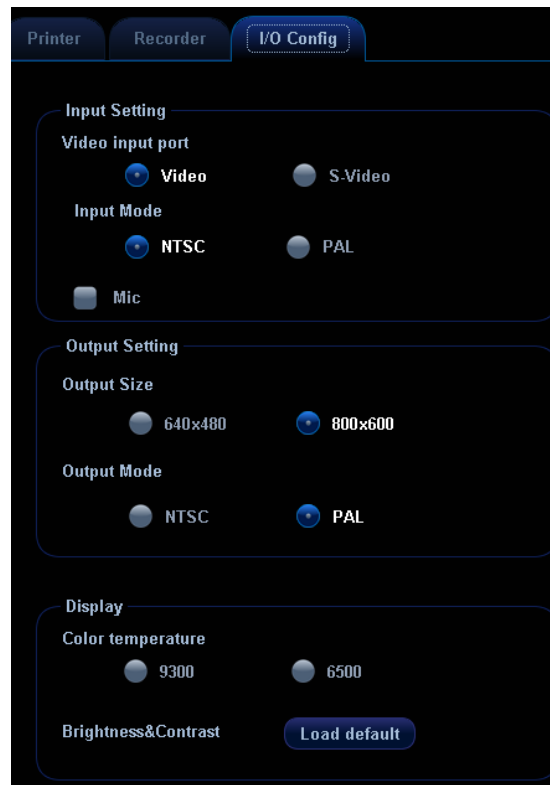

## 17.10 Network Storage

Please refer to the DICOM chapter and “Network Storage” section for details about network settings.

## 17.11 Manage Settings

The Manage Settings page is used to import or export the setup data or restore factory setup data.

### 17.11.1 Exporting Setup Data

This function is used to write all setup data of the system into a disk for back-up. The format of the data file is .DTA.

The procedures are described as follows:

- 1 Select some or all items in the [Export] field on the left side of the [Manage Settings] screen.
- 2 Click [Export] to open the [Export Data] screen.
- 3 Select the path to save the data.
- 4 Select the exported file and type as DTA.
- 5 Click [OK].

### 17.11.2 Importing Setup Data

This function is used to import the existing setup data to the setup data memory of the system. The system will reset and operate according to the setup preferences that were imported.

The procedures are described as follows:

- 1 Select an item in the [Import] field on the right side of the [Manage Settings] screen.
- 2 Click [Import] to open the [Import Data] screen.
- 3 Select the path to save the data.
- 4 Select the imported file and type as DTA.
- 5 Click [OK].
- 6 To restore the factory setup data, click [Restore Factory] on the right side of the screen.

You can use [Export], [Import All], or [Restore Factory] at the bottom of the screen to export, import all setup data of the system or restore all factory setup data of the system. The operating methods are the same as those mentioned above.

## 17.12 Maintenance

The [Maintenance] item is designed for you to update the system software or other special functions. If you require these functions, please contact Mindray Customer Service



Department or sales representative.

Through the menu, you can perform net update, remote desktop, system test, log operation, etc.

## 17.13 System Information

Select the [About] item in the Setup menu to enter the system information screen, which displays the system software version and versions of other devices. You cannot edit the information but can only view them. This information varies depending upon the system configurations and version.



# 18 Probes and Biopsy

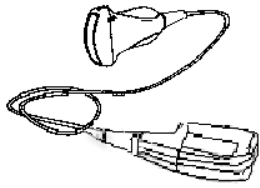
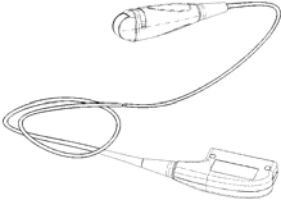
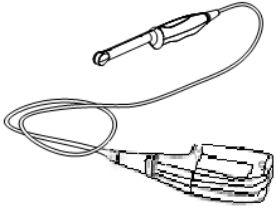
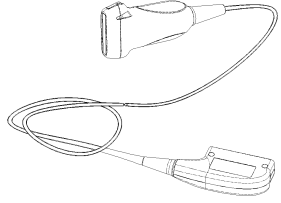
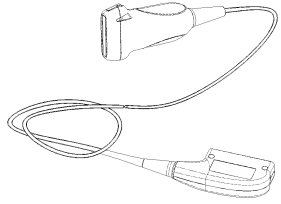

---

## 18.1 Probes

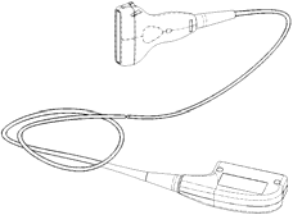
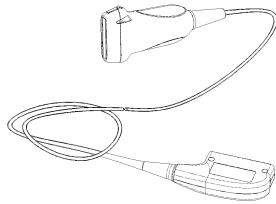
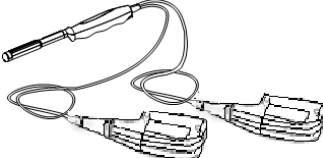
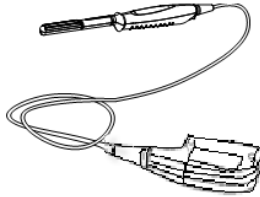
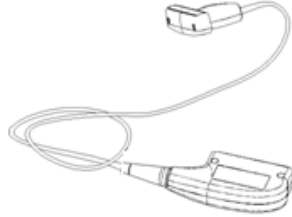
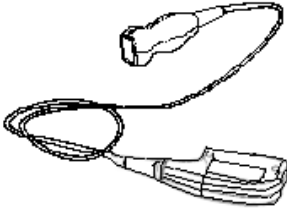
The system supports the following probes:

No.	Probe Model	Illustration
1.	3C5s	
2.	3C1s	
3.	6CV1s	
4.	7L4s	
5.	7L5s	

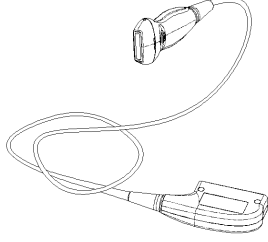
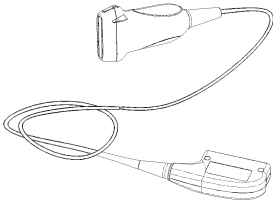
No.	Probe Model	Illustration
6.	7L6s	 A line drawing of a medical probe. It features a rectangular handle with a small circular feature on top, connected by a thin cable to a larger, more complex probe head with a curved, hook-like tip.
7.	10L4s	 A line drawing of a medical probe, similar in design to model 7L6s. It has a rectangular handle with a circular feature, connected to a probe head with a curved tip.
8.	6LB7s	 A line drawing of a medical probe. The handle is cylindrical and tapers to a fine needle-like tip. It is connected to a probe head with a complex, multi-faceted structure.
9.	6LE7s	 A line drawing of a medical probe. The handle is cylindrical and tapers to a fine needle-like tip. It is connected to a probe head with a complex, multi-faceted structure.
10.	7LT4s	 A line drawing of a medical probe. It has a rectangular handle with a circular feature, connected to a probe head with a curved tip.
11.	2P2s	 A line drawing of a medical probe. The handle is rectangular with a circular feature, connected to a probe head with a curved tip.
12.	6C2s	 A line drawing of a medical probe. The handle is cylindrical and tapers to a fine needle-like tip. It is connected to a probe head with a complex, multi-faceted structure.

No.	Probe Model	Illustration
13.	6LE5Vs	
14.	L14-6s	
15.	L11-4s	
16.	P4-2s	
17.	C5-2s	

### 18.1.1 Name and Function of Each Part of the Probe

The basic structures and corresponding functions of probes are basically the same; the following will take probe 7L4s as an example to illustrate.

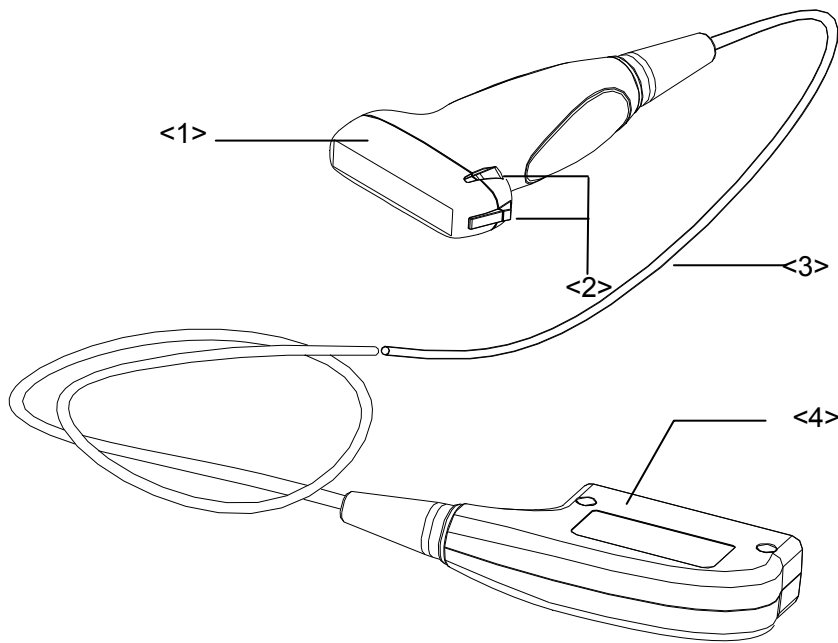

No.	Name	Function
<1>	Probe head	It converts the electrical signal into ultrasound signal, making the sound beams focus in the given direction; meanwhile, it will receive the ultrasound signal and then convert the received signal into electrical signal. The lens on the surface is the acoustic lens. Apply ultrasound gel on the acoustic lens.
<2>	Needle-guided bracket fix tabs and grooves	Used to mount the needle-guided bracket.
<3>	Probe cable	Used to transmit electrical signals between the probe body and connector.
<4>	Probe connector	Used to connect the probe to the ultrasonic diagnostic system.

**Tips:**

The part marked <2> in the figure above may vary with the matched needle-guided brackets.

6LE7s probe:

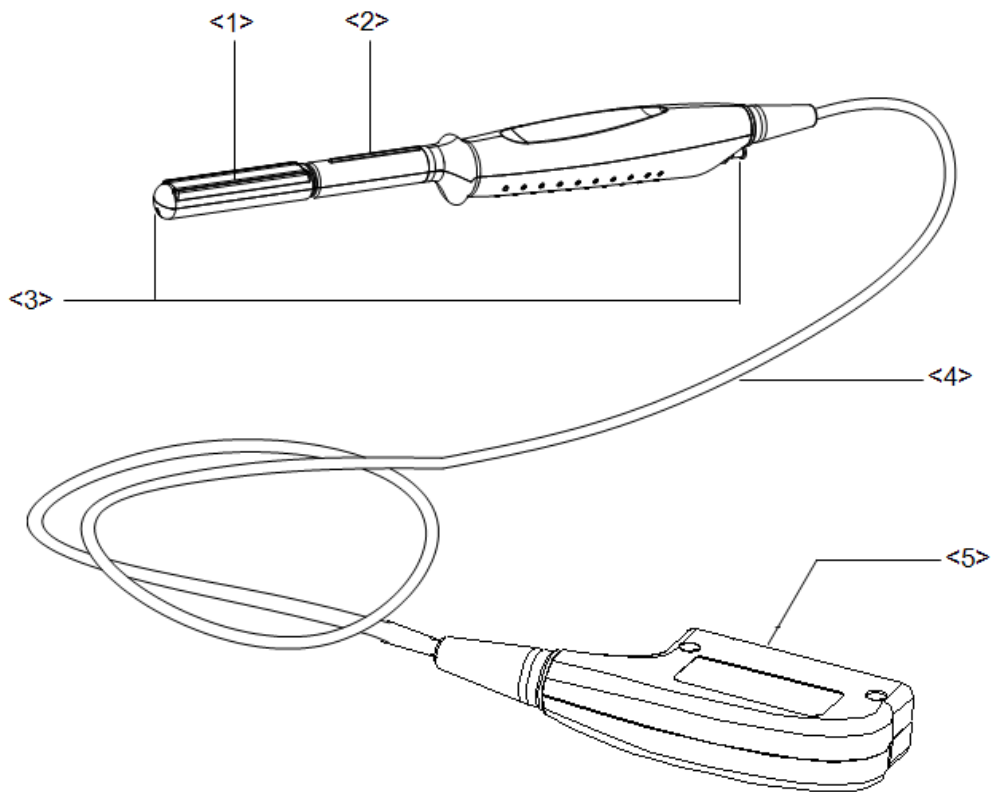

NO.	Name	Function
<1>	Transducer head	It utilizes the piezoelectric effect to convert electrical signals into ultrasound waves, which are transmitted to the body, and to generate electrical signals when receiving the reflected ultrasound waves (echoes).The lens on the surface is the acoustic lens. Apply ultrasound gel on the acoustic lens.
<2>	Needle-guided bracket fix tab	Mount the needle-guided bracket using this tab.
<3>	Water injection/drainage port	Used for inject/drain water
<4>	Cable	This transmits electrical signals between the transducer body and connector.
<5>	Connector	This connects the transducer to the ultrasonic diagnostic system.

6LB7s probe:

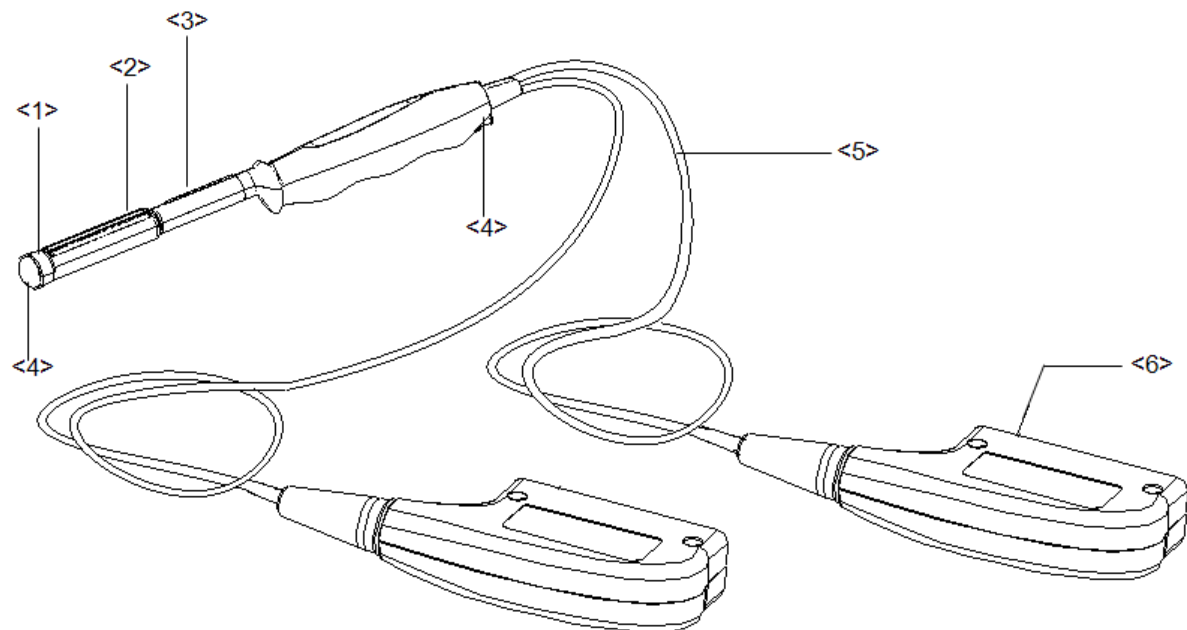

No.	Name	Function
<1> <2>	<1>Transducer head (convex) <2>Transducer head (linear)	It utilizes the piezoelectric effect to convert electrical signals into ultrasound waves, which are transmitted to the body, and to generate electrical signals when receiving the reflected ultrasound waves (echoes).The lens on the surface is the acoustic lens. Apply ultrasound gel on the acoustic lens.
<3>	Needle-guided bracket fix tab	Mount the needle-guided bracket using this tab.
<4>	Water injection/drainage port	Used for inject/drain water
<5>	Cable	This transmits electrical signals between the transducer body and connector.
<6>	Connector	This connects the transducer to the ultrasonic diagnostic system.

## 18.1.2 Orientation of the Ultrasound Image and the Probe Head

The orientation of the ultrasound image and the probe are shown as below. The “Mark” side of the ultrasound image on the monitor corresponds to the mark side of the probe. Check the orientation before the examination (Here takes linear probe as an example).

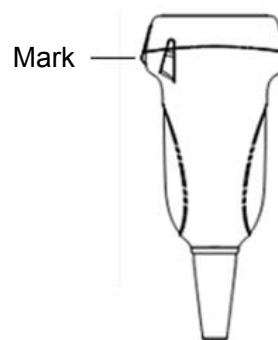
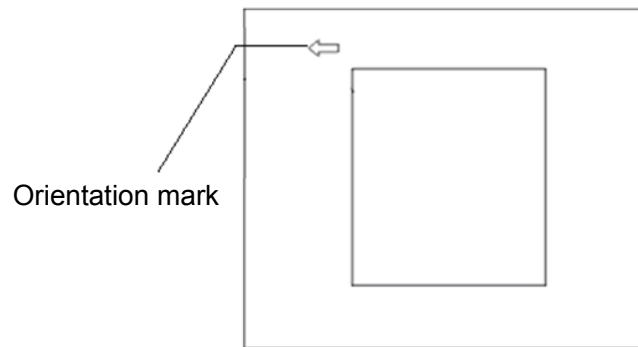

## 18.1.3 Procedures for Operating

This section describes general procedures for operating the probe. The proper clinical technique to be used for operating the probe should be selected on the basis of specialized training and clinical experience.



Procedures for operating (with biopsy function):

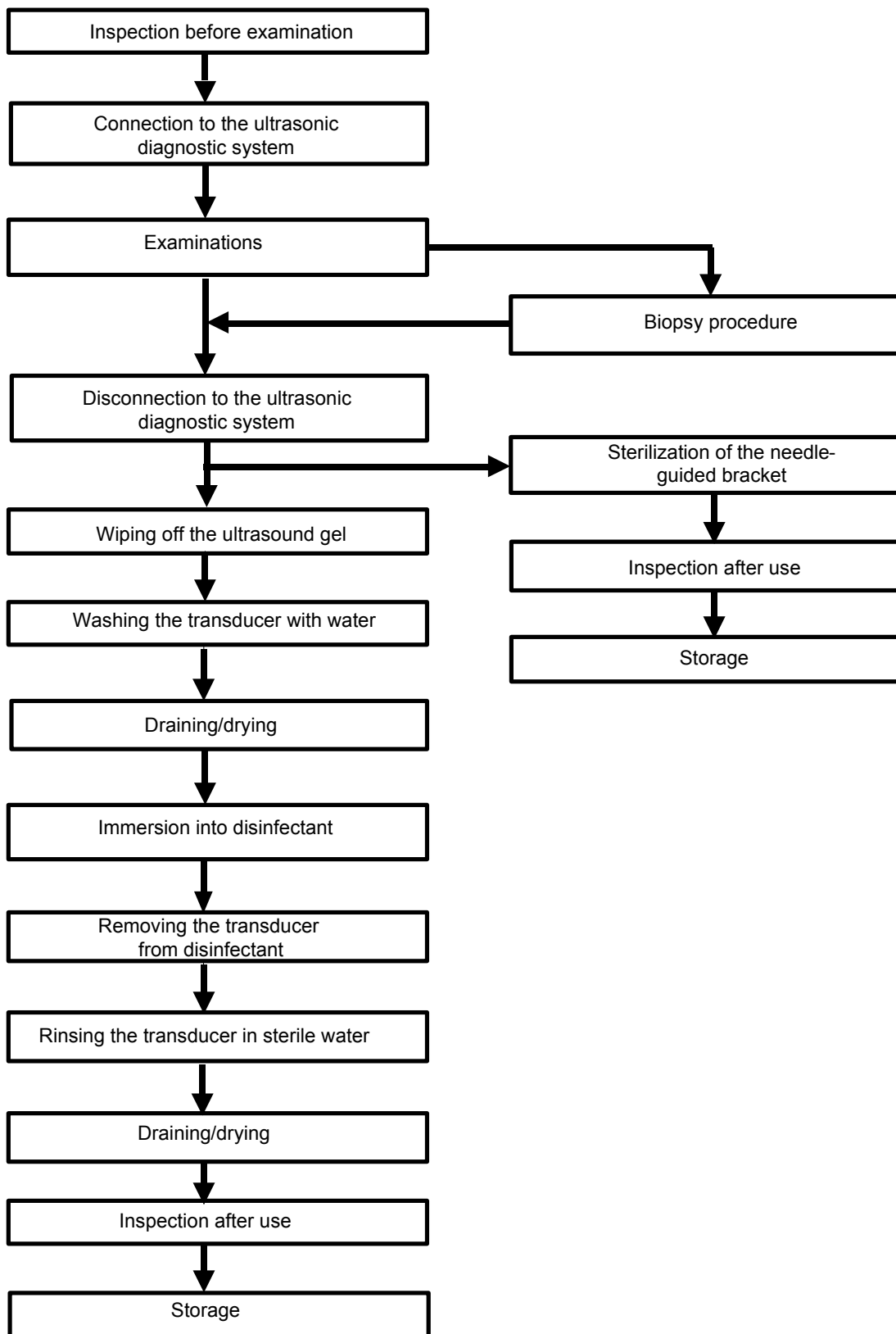

Procedures for operating (with no biopsy function):

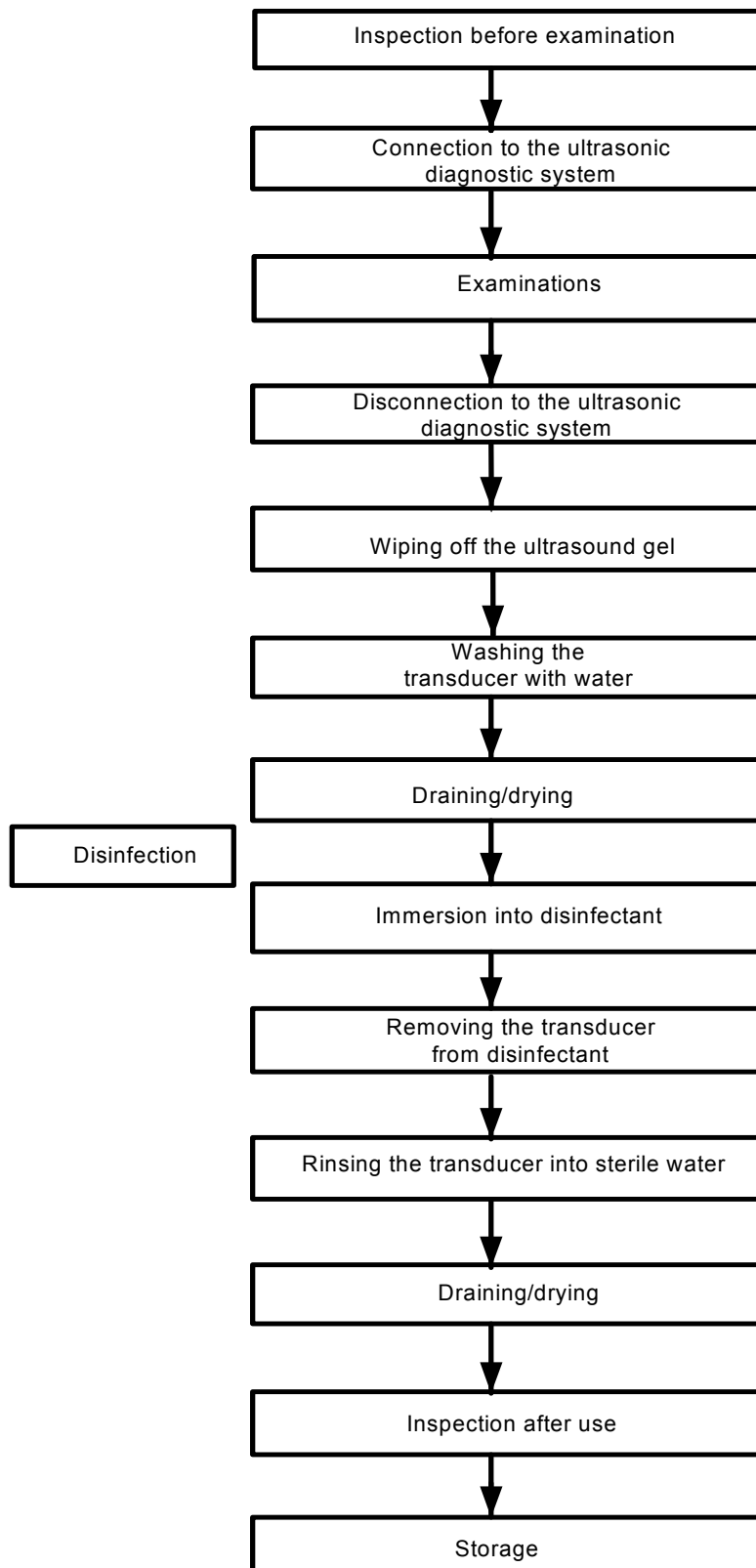

**⚠ WARNING:**

**Disinfect the probe and sterilize the needle-guided bracket before and after an ultrasound-guided biopsy procedure is performed. Failure to do so may cause the probe and the needle-guided bracket become source of infection.**

## 18.1.4 Wearing the Probe Sheath

A legally marketed probe sheath must be installed over the probe before performing intra-cavitary and intra-operative examination. Protective barriers may be required to minimize disease transmission. Probe sheaths are available for use with all clinical situations where infection is a concern.

To order probe sheath, contact:

CIVCO Medical Instruments Co.

102 First Street South, Kalona, IA 52247-9589 USA Tel: 1-319-656-4447

E-mail: [info@civco.com](mailto:info@civco.com)

<http://www.civco.com>

**⚠ CAUTION:**

1. **Be sure to cover the probe with a new (unused) probe sheath to prevent infection during examination. If the package of a probe sheath is open or broken, the sterilization of the probe sheath may not be sufficient. DO NOT use such a probe sheath.**
2. **The cover contains natural rubber latex and talc that can cause allergic reactions in some individuals.**
3. **DO NOT use an expired probe sheath. Before using probe sheaths, verify whether the term of validity has expired.**

Method (for reference only):

1. Place an appropriate amount of gel inside the sheath or on probe face. Poor imaging may result if no gel is used.
2. Insert the probe into the sheath; make sure to use proper sterile technique. Pull cover tightly over probe face to remove wrinkles and air bubbles, taking care to avoid puncturing cover.

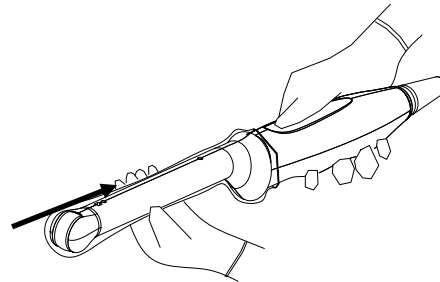
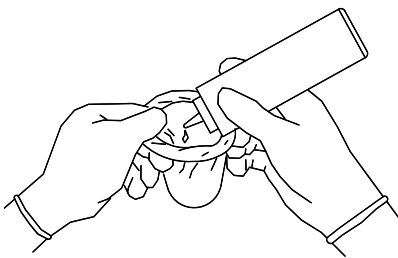

3. Secure the sheath with enclosed elastic bands.
4. Inspect the sheath to ensure there is no hole or tear.

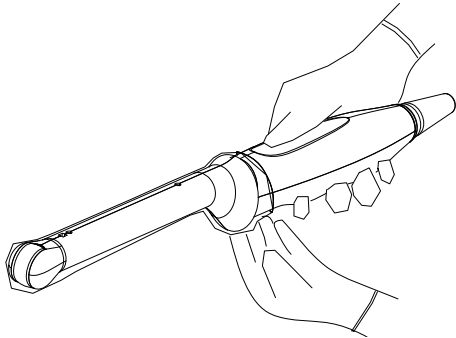

### 18.1.5 When the Immersion Method is used (for 6LB7 and 6LE7)

The transducer manufacturer recommends a syringe: CIVCO 610-224. Here takes transducer 6LB7s as an example to introduce the immersion method.

Please perform the following operations before using the syringe.

1. Open the syringe pack and take out the syringe.
2. See the following figure; take out the dustproof cap at the end of the syringe's extension tube.



3. See the following figure, push back the locking nut and make the connector come out. The connector will be connected to the transducer's injection/drainage port.

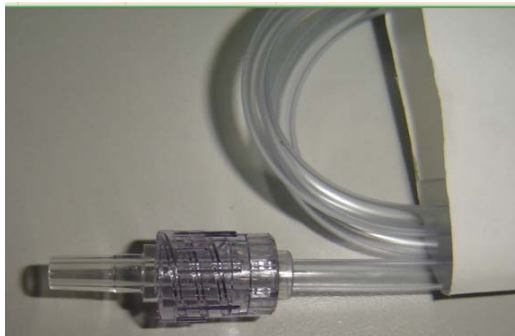

Please refer to the following operations when the immersion method is used.

1. Put on the transducer cover.  
For the procedures of putting on the transducer sheath, refer to subsection above. Check the transducer sheath for wrinkles and gaps.

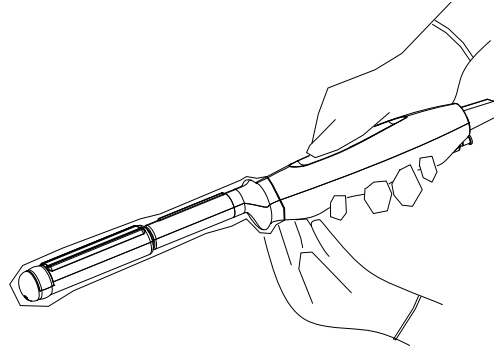

2. Fill syringe with sterile water and connect extension tube to syringe, discharge all air in the tube. Attach the syringe to transducer fill port.

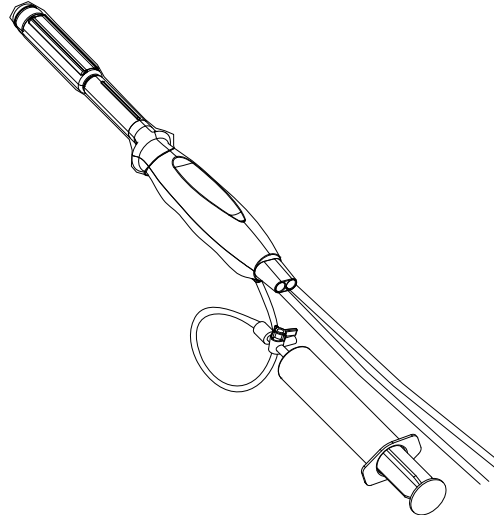

3. Orientate the transducer downward and inject sterile water up to the level a few cm above the end of the transducer surface.

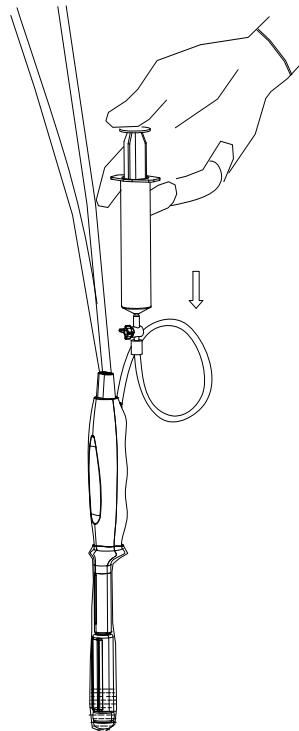

4. Orientate the transducer upward to discharge air in the transducer cover.

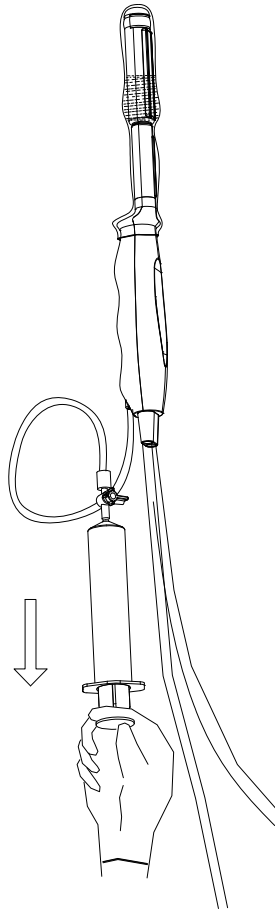

5. Turn the valve of the syringe to the position shown in the right figure, and then push the plunger of the syringe to discharge the air.

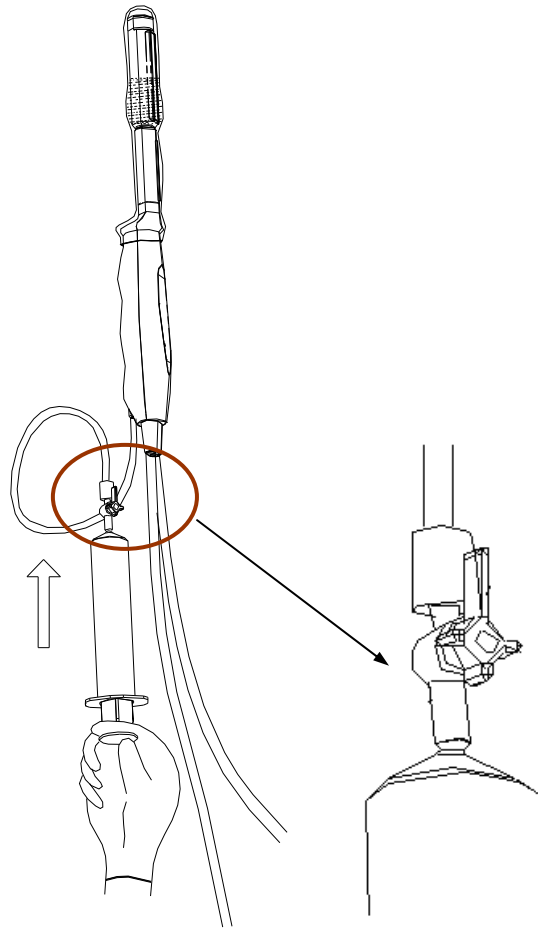

6. Return the valve of the syringe to the original position; orientate the transducer downward to discharge sterile water.

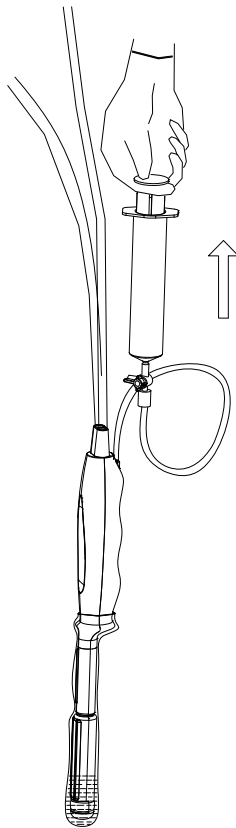

## 18.1.6 Probes Cleaning and Disinfection (or Sterilization)

After completing each examination, clean and disinfect (or sterilize) the probes as required. When biopsy procedures have been performed, be sure to sterilize the needle-guided bracket. Fail to do so may result in the probe and the needle-guided bracket to becoming sources of infection. Please follow the instructions in the manual for cleaning.



### **WARNING:**

**Never immerse the probe connector into liquid such as water or disinfectant. Immersion may cause electrical shock or malfunction.**



### **CAUTION:**

1. **When performing cleaning and disinfection of the probe to prevent infection, wear sterile gloves.**



2. **After disinfection, rinse the probe thoroughly with sterile water to remove all chemical residues. Chemical residues on the probe may be harmful to the human body.**

3. **No cleaning and disinfecting may result in the probe becoming a source of infection.**

### **NOTE:**

1. After the examination, wipe off the ultrasound gel thoroughly. Otherwise, the ultrasound gel may solidify and degrade the image quality of the transducer.
2. DO NOT make the probe to become overheated (more than 55°C) during cleaning and disinfections. High temperature may cause the probe to become deformed or damaged.

### **Cleaning**

Please refer to the instructions in the manual and follow your hospital policy and procedures for cleaning.

1. Disconnect the probe from the system.
2. Wear sterile gloves to prevent infection.
3. Wash the transducer with clean water or soapy water to remove all the foreign matters, or, wipe the transducer with a soft ethyl carbamate sponge. Avoid using a brush, because it may damage the transducer.
4. Dry the transducer using a sterile cloth or gauze after rinsing. Do not dry the transducer by heating it.

### **Disinfecting with Sprays**



### **CAUTION:**

Use protective eyewear when disinfecting using sprays.

1. Wear sterile gloves to prevent infection.



2. After you have finished cleaning, spray the transducer with a disinfectant. Follow the disinfectant manufacturer's recommended contact time and mode.
3. Remove any residue with a water-moistened soft cloth on the transducer.
4. Wipe off water on the transducer using sterile cloth or gauze after washing.

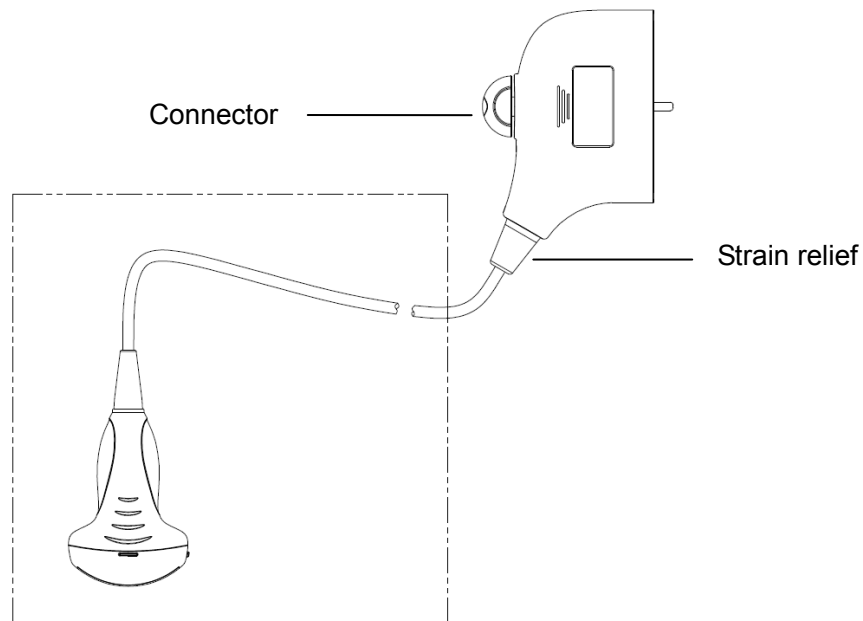

**NOTE:** Observe the graph here carefully to perform disinfection. Do not spray the strain relief on the connector end or the connector.

### Disinfecting by Immersion

1. Wear sterile gloves to prevent infection.
2. Clean the transducer before disinfecting it. MINDRAY recommends the following solutions to disinfect the transducer.
  - Refer to the instructions provided by the chemical manufacturer concerning concentration of the disinfectant solution, method of disinfection and dilution and cautions during use. Do not soak the transducer connector or the cable near it into water or any solution.
  - Soak the transducer into the disinfectant solution for the shortest time the manufacturer recommends (for example, the shortest time recommended by the manufacturer for soaking Cidex OPA is 12 minutes).
  - Follow local regulations when selecting and using the disinfectant.
3. Rinse the transducer with plenty of sterile water (about 2 gallons) for at least 1 minute to remove all chemical residues on it. Or, follow the rinsing method recommended by the disinfectant manufacturer to rinse the transducer.
4. Wipe off the water on the transducer with sterile cloth or gauze after rinsing it. Do not dry the transducer by heating.

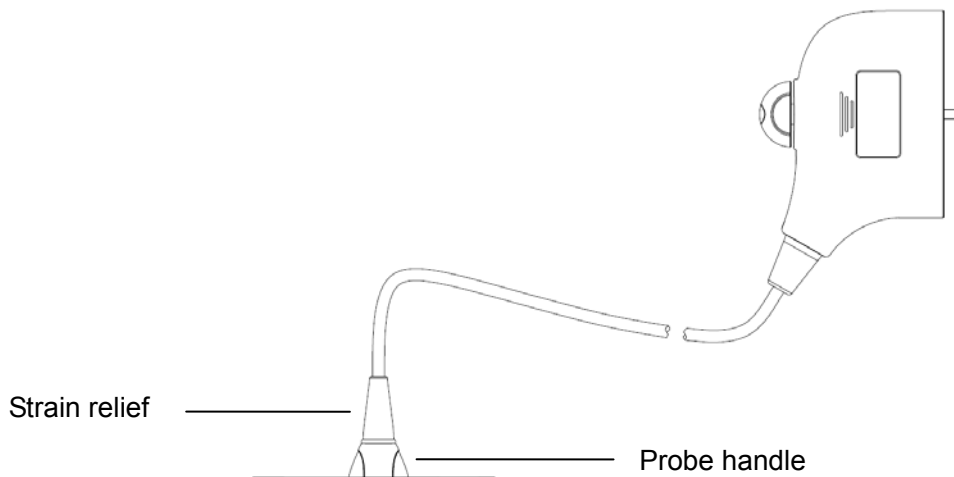

- NOTE:**
1. Observe the graph here carefully to immerse the transducer. Only soak parts of the transducer below the strain relief.
  2. Repeated disinfection will eventually damage the probe, please check the probe performance periodically.

### Compatible Disinfectants

Manufacturer	Trade Name	Procedures	Type
Pharmaceutical Innovations, Inc.	T-Spray II	Please refer to the instructions provided by the manufacturer of the solution for details.	Spray*
Parker Laboratories Inc.	PROTEX™ DISINFECTANT SPRAY	Please refer to the instructions provided by the manufacturer of the solution for details.	Spray*
Metrex	MetriZyme	Please refer to the instructions provided by the manufacturer of the solution for details.	Solution*
ASP	Cidex Activated Glutaraldehyde Solution (applicable for CE region)  Cidex Activated Dialdehyde Solution (applicable for FDA region)	Please refer to the instructions provided by the manufacturer of the solution for details.	Solution
ASP	Cidex OPA	Please refer to the instructions provided by the manufacturer of the solution for details.	Solution
Nanosonics Limited	TrophonSonex-HL (Used with Trophon EPR Ultrasound Probe Disinfector)	Please refer to the instructions provided by the manufacturer of the solution for details.	Solution**

Manufacturer	Trade Name	Procedures	Type
Ecolab Inc. (not available for FDA region)	Ster-Bac	Please refer to the instructions provided by the manufacturer of the solution for details.	Solution
Antiseptica (not available for FDA region)	Triacid-N	Please refer to the instructions provided by the manufacturer of the solution for details.	Solution***
Minntech Corporation (not available for FDA region)	Minnicare® Cold Sterilant	Please refer to the instructions provided by the manufacturer of the solution for details.	Solution***

\* denotes if the disinfectant is not applicable for following probes: 10L4s

\*\* denotes if the disinfectant is not applicable for following probes: 10L4s

\*\*\* denotes if the disinfectant is not applicable for following probes: 6CV1s

The probe C5-2s only uses the disinfectant PROTEX™ and CIDEX OPA.

## Sterilization

For intra-operative probes (7LT4s), they have to be sterilized after completing each examination.

1. Wear sterile gloves to prevent infection.
2. Clean the probe before sterilizing it. MINDRAY recommends the following solutions to sterilize the probe.

Hydrogen Peroxide and Peroxyacetic Acid -based sterilization solution

Trade Name	Chemical Name	Procedures
Minnicare® Cold Sterilant	22% Hydrogen Peroxide 4.5% Peroxyacetic Acid	Dilute the sterilant with sterilized purified water (1:20). Immersed time: 11 hours. Temperature: 20°C-25°C.

Glutaraldehyde-based sterilization solution

Trade Name	Chemical Name	Procedures
Cidex Activated Glutaraldehyde Solution (applicable for CE region)	2.2-2.7% Glutaraldehyde	Please refer to the instructions provided by the manufacturer of the solution for details.
Cidex Activated Dialdehyde Solution (applicable for FDA region)	2.4% Glutaraldehyde	

- Refer to the instructions provided by the chemical manufacturer concerning concentration of the sterilization solution, method of sterilization and dilution and cautions during use.
- Do not soak the probe connector or the cable near it into water or any solution.
- Follow local regulations when selecting and using the sterilization solution.

3. Rinse the probe with plenty of sterile water (about 2 gallons) for at least 1 minute to remove all chemical residues on it. Or, follow the rinsing method recommended by the sterilization solution manufacturer to rinse the probe.
4. Wipe off the water on the probe with sterile cloth or gauze after rinsing it. Do not dry the probe by heating.

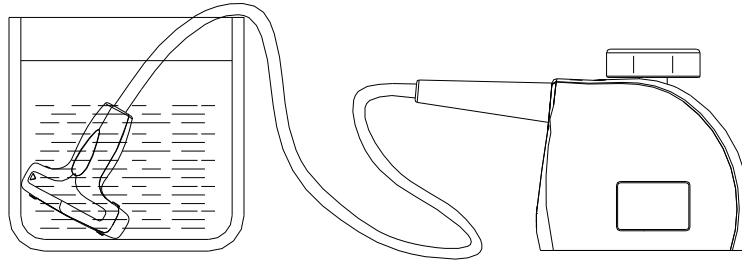

Immerse the probe in the solution (for reference only)

- NOTE:**
1. The lens may be discolored; the label on the probe may fade. These are not abnormalities.
  2. Repeated disinfection may degrade the performance and safety of the probe.

### 18.1.7 Storage and Transportation

When all examinations for the day have been completed, confirm that the probe is in good condition. After disinfecting the probe, confirm that the probe is in good condition and store it in a suitable place so that the next examination can be conducted smoothly.

1. To prevent the probe from being damaged, DO NOT store it in locations where it may be exposed to:
  - Direct sunlight or X-rays
  - Sudden changes in temperature
  - Dust
  - Excessive vibration
  - Heat generators
2. Store and transport the probe under the specified ambient conditions.
3. When the probe is sent to MINDRAY Customer Service Department or sales representative for repair, be sure to disinfect it and keep it in the carrying case to prevent infection.
4. Sterilize the carrying case as necessary.

## 18.2 Biopsy Guide

- ⚠ WARNING:**
1. The person performing biopsy procedures must understand diagnostic ultrasound thoroughly and have been trained adequately, otherwise, side effects may be caused to the animal.
  2. In situations listed below, the biopsy needle may fail to penetrate the target. The incorrect biopsy may cause various side effects in the animal.

- Use a needle-guided bracket other than that provided.
  - Mount the needle-guided bracket incorrectly.
  - Use a biopsy needle that is unsuitable for the type of biopsy being performed.
  - Use a biopsy needle that is unsuitable for the needle guide.
3. Before and after a biopsy procedure is performed, confirm that the needle-guided bracket is normal. Manually confirm that the parts of the needle-guided bracket do not slip off or move from their proper positions. If the needle-guided bracket is used when parts are not securely and correctly installed, animal may be injured. If an abnormality is found on the needle-guided bracket, immediately stop using it and contact MINDRAY Customer Service Department or sales representative.
  4. DO NOT use a needle-guided bracket when scanning is performed. The needle may advance in an incorrect direction and possibly injure the animal.  
Never perform a biopsy during image scanning.
  5. DO NOT freeze an image while performing biopsy procedure.
  6. During biopsy procedures, the needle may deviate from the desired course due to the tissue characteristics or the type of needle. In particular, needles of small diameters may deviate to a greater degree.
  7. Disinfect the probe and sterilize needle-guided bracket before and after each ultrasound-guided biopsy procedure is performed. Fail to do so may cause the probe and the needle-guided bracket become sources of infection.
  8. The needle mark displayed on the ultrasound image does not indicate the actual position of the biopsy needle. Therefore, it should only be used as a reference. Always monitor the relative positions of the biopsy needle during the procedures.
  9. Adjust the needle mark before the biopsy procedure is performed.
  10. When performing biopsy procedures, use only sterile ultrasound gel that is certified to be safe. And manage the ultrasound gel properly to ensure that it does not become a source of infection.
  11. When performing the operation concerning biopsy, wear sterile gloves.
  12. Image of the biopsy target and the actual position of the biopsy needle:  
Diagnostic ultrasound systems produce tomographic plane images with information of a certain thickness in the thickness direction of the probe. (That is to say, the information shown in the images consist all the information scanned in the thickness direction of the probe.) So, even though the biopsy needle appears to have

penetrated the target object in the image, it may not actually have done so. When the target for biopsy is small, dispersion of the ultrasound beam may lead to image deviate from the actual position. Pay attention to this.

If the target object and the biopsy needle appear in the image as shown in the figures below (For reference only):

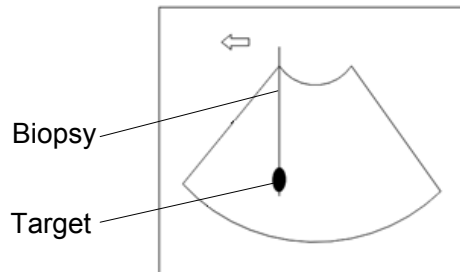

The biopsy needle appears to reach the target object in the image

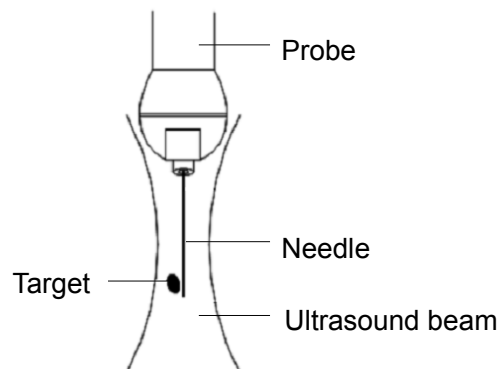

Dispersion of the ultrasound beam

**The biopsy needle may not have actually entered the target object even though it appears to have done so on the image. To avoid this problem, note points below:**

- Do not rely only on the needle tip on the image. Pay careful attention to that, when the biopsy needle comes into the target object or contacts with it, the object should shift slightly.
- Before you perform the biopsy, please evaluate the size of the object and confirm if the biopsy can be carried out.

## 18.2.1 Needle-guided Brackets

A needle-guided bracket is available for purchase as an optional accessory; it is used in combination with the probe. Some of the probes have matched needle-guided bracket and needles. To order needle-guided brackets, contact MINDRAY Customer Service Department or sales representative.

For biopsy or treatment, ultrasound-guided biopsy procedures can be performed using the probe in combination with a needle-guided bracket (optional accessory) and a biopsy needle (provided by the user).

### 18.2.2 Names of Parts

This section describes the parts and corresponding functions of each needle-guided bracket. Here, we take a matched probe as an example.

- NGB-004

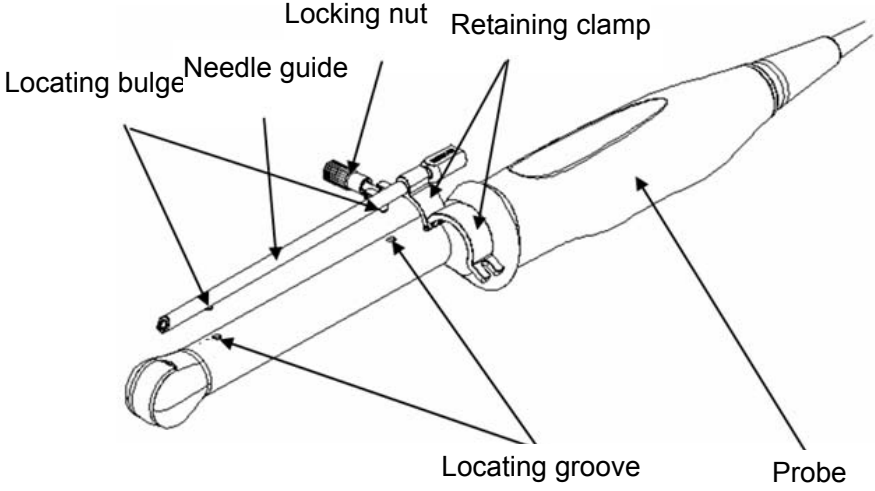

■ NGB-005

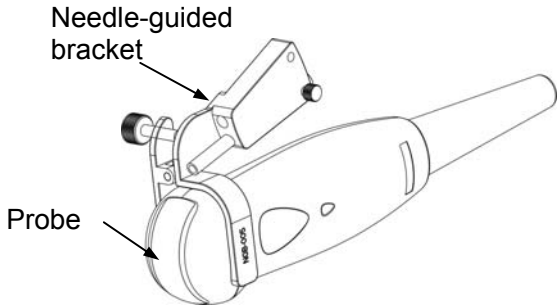
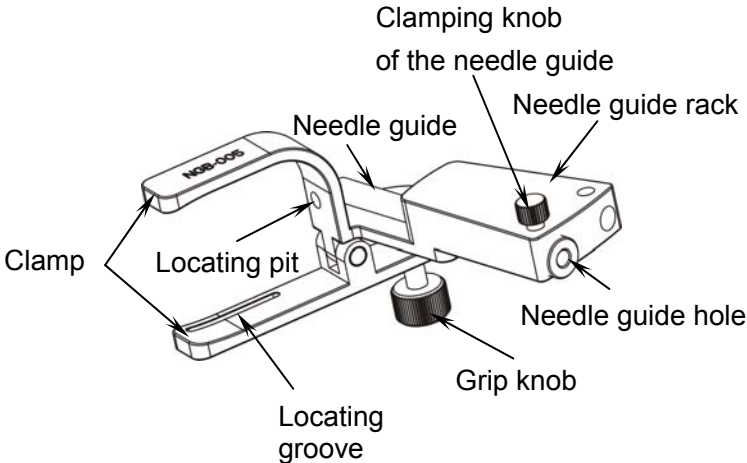



■ NGB-006

Metal/needle detachable needle-guided bracket:

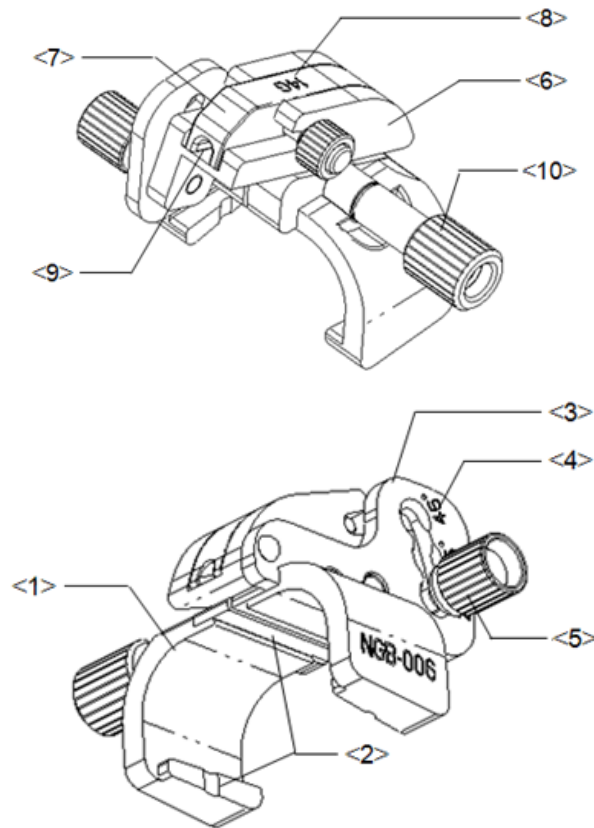

No.	Name	Description
<1>	Support of needle-guided bracket	Used for installing the needle-guided bracket on the probe.
<2>	Groove and tab of the needle-guided bracket	Respectively matched with the tab and groove of the probe.
<3>	Angle adjusting base	There are 3 types of angles available to be adjusted.
<4>	Angle shift sign (25°, 35°, 45°)	Matched with the biopsy angle (25°, 35°, and 45°).
<5>	Angle pinch nut	Used for fixing the angle block at a chosen angle.
<6>	Angle block	Used for fixing the angle block at a certain angle.
<7>	Guiding block	Used for installing biopsy needle; there are five specifications of guiding blocks for different biopsy needles.
<8>	Specification of guiding block (14G)	Matched with the corresponding biopsy needle (14G).
<9>	Guiding hole of the biopsy needle	Used for installing the biopsy needle.
<10>	Pinch nut of needle-guided bracket	Used for locking the needle-guided bracket and the probe.

Plastic/needle detachable needle-guided bracket:

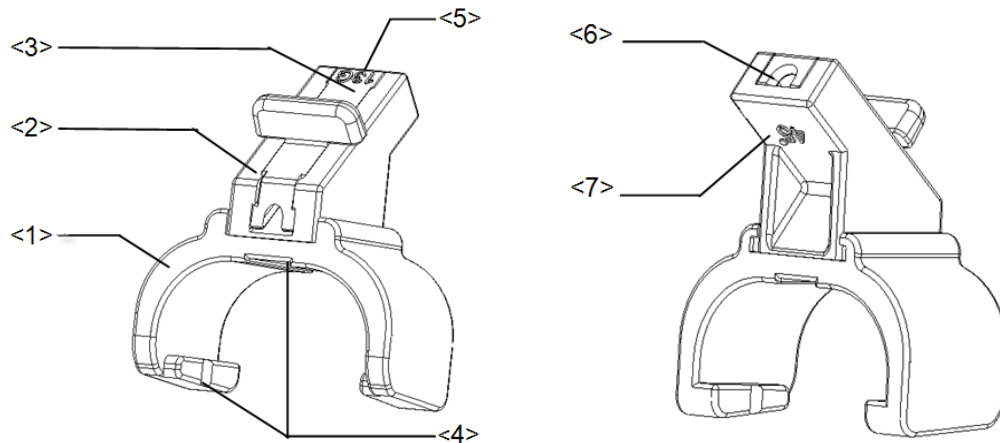

No.	Name	Description
<1>	Support of needle-guided bracket	Used for installing the needle-guided bracket on the probe.
<2>	Angle block	Used for determining the angle of the biopsy; there are three specifications of blocks of angle.
<3>	Guiding block	Used for installing biopsy needle; there are five specifications of guiding blocks for different biopsy needles.
<4>	Groove and tab of the needle-guided bracket	Respectively matches with the tab and groove of the probe.
<5>	Specification of guiding block (13G)	Matched with the corresponding biopsy needle (13G).
<6>	Guiding hole of the biopsy needle	Used for installing the biopsy needle.
<7>	Specification of angle block (45°)	The corresponding biopsy angle is 45°.

■ NGB-007

Metal/needle detachable needle-guided bracket:

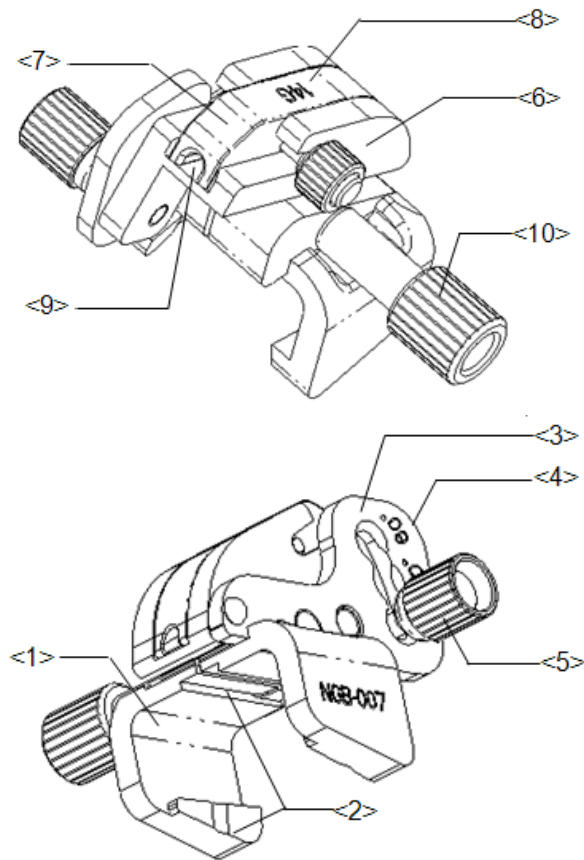

No.	Name	Description
<1>	Support of needle-guided bracket	Used for installing the needle-guided bracket on the probe.
<2>	Groove and tab of the needle-guided bracket	Respectively matched with the tab and groove of the probe.
<3>	Angle adjusting base	There are 3 types of angles available to be adjusted.
<4>	Angle shift sign (40°, 50°, 60°)	Matched with the biopsy angle (40°, 50°, and 60°).
<5>	Angle pinch nut	Used for fixing the angle lock at a chosen angle.
<6>	Angle block	Used for determining the angle of the biopsy; different specifications of blocks can be used.
<7>	Guiding block	Used for installing biopsy needle; there are five specifications of guiding blocks for different biopsy needles.
<8>	Specification of guiding block (14G)	Matched with the corresponding biopsy needle (14G).
<9>	Needle guide hole	Used for installing the biopsy needle.
<10>	Pinch nut of needle-guided bracket	Used for locking the needle-guided bracket and the probe.

Plastic/needle detachable needle-guided bracket:

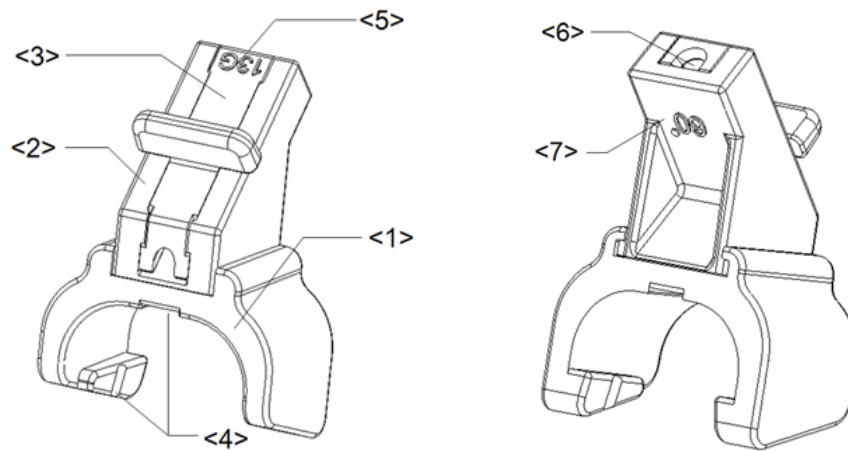

No.	Name	Description
<1>	Support of needle-guided bracket	Used for installing the needle-guided bracket on the probe.
<2>	Angle block	Used for determining the angle of the biopsy; there are three specifications of blocks of angle.
<3>	Guiding block	Used for installing biopsy needle; there are five specifications of guiding blocks for different biopsy needles.
<4>	Groove and tab of the needle-guided bracket	Respectively matches with the tab and groove of the probe.
<5>	Specification of guiding block (13G)	Matched with the corresponding biopsy needle (13G).
<6>	Guiding hole of the biopsy needle	Used for installing the biopsy needle.
<7>	Specification of angle block (60°)	The corresponding biopsy angle is 60°.

■ NGB-008

Plastic/needle-detachable needle-guided bracket:

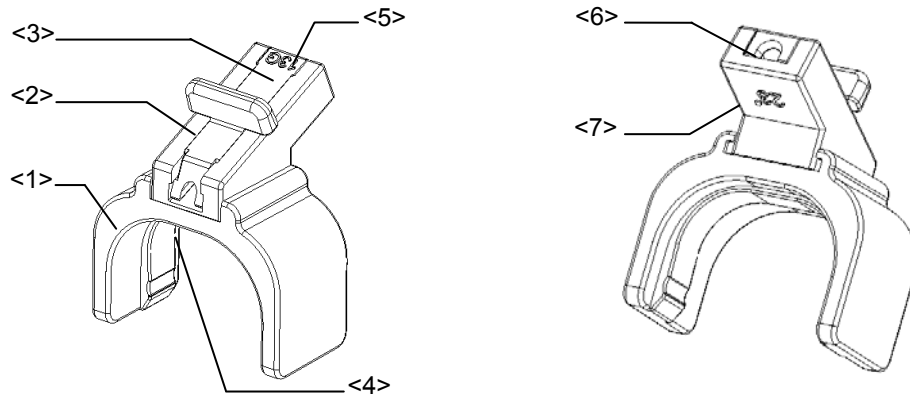

No.	Name	Description
<1>	Support of needle-guided bracket	Used for installing the needle-guided bracket on the transducer
<2>	Angle block	Used for determining the angle of the biopsy; there are two specifications of blocks of angle
<3>	Guiding block	Used for installing biopsy needle; there are five specifications of guiding blocks for different biopsy needles
<4>	Tab of the needle-guided bracket	Matched with the groove of the transducer
<5>	Specification of guiding block (13G)	Matched with the corresponding biopsy needle (13G)
<6>	Guiding hole of the biopsy needle	Used for installing the biopsy needle
<7>	Specification of angle block (23°)	Corresponding to the size of the biopsy angle (23°)

Metal/needle-detachable needle-guided bracket:

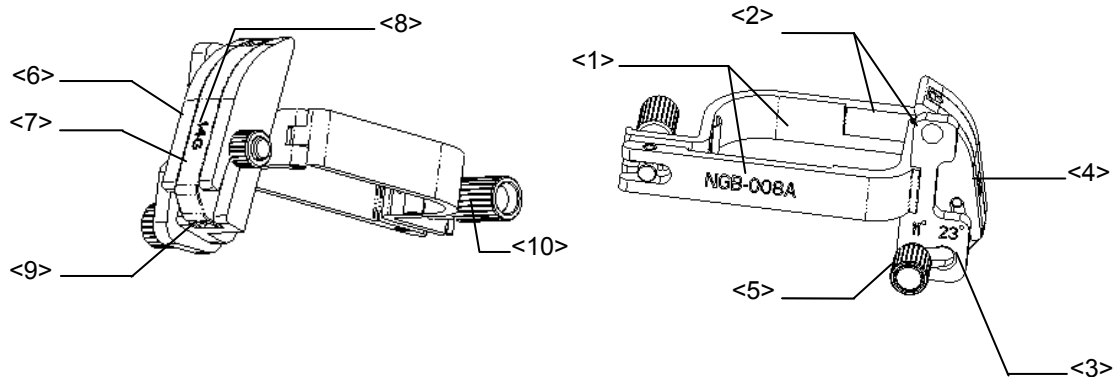

No.	Name	Description
<1>	Clamp of needle-guided bracket	Used for installing the needle-guided bracket on the transducer
<2>	Groove and tab of needle-guided bracket	Respectively matched with the tab and groove of the transducer
<3>	Angle adjusting base	There are 2 types of angles available to be adjusted
<4>	Angle shift sign (11° , 23° )	Matched with the biopsy angle (11° , 23° )
<5>	Angle pinch nut	Used for fixing the angle lock at a certain angle
<6>	Angle block	Used for determining the angle of the biopsy; different specifications of blocks can be used
<7>	Guiding block	Used for installing biopsy needle; there are five specifications of guiding blocks for different biopsy needles
<8>	Specification of guiding block (14G)	Matched with the corresponding biopsy needle (14G)
<9>	Needle guide hole	Used for installing the biopsy needle
<10>	Pinch nut of needle-guided bracket	Used for locking the needle-guided bracket and the transducer

■ NGB-009

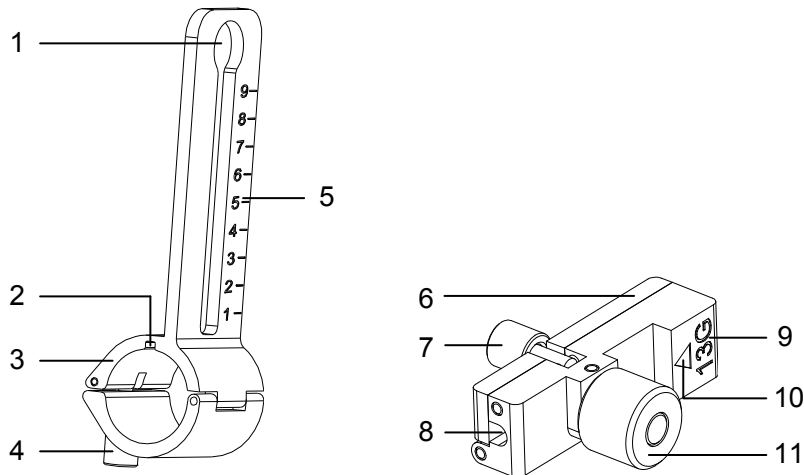

No.	Name	Description
<1>	Support of needle-guided bracket	Used for installing the needle-guided bracket on the transducer
<2>	Knob of fixing needle-guided bracket	Used for fixing the needle-guided bracket on the transducer
<3>	Groove	Match with the tab on the transducer
<4>	Hole for installing guiding block	Used for installing the knob of fixing needle-guided bracket
<5>	Needle distance scales	Indicate distance between needle and the transducer head surface
<6>	Guiding block	Used for installing biopsy needle; there are five specifications of guiding blocks for different needles
<7>	Knob of fixing the needle	Used for fixing the needle
<8>	Guiding hole of the needle	Used for installing the biopsy needle
<9>	Specification of guiding block	Matched with the corresponding biopsy needle
<10>	Mark of indicating scales	Indicating needle distance scales
<11>	Knob of fixing the guiding block	Used for fixing the guiding block

■ NGB-010

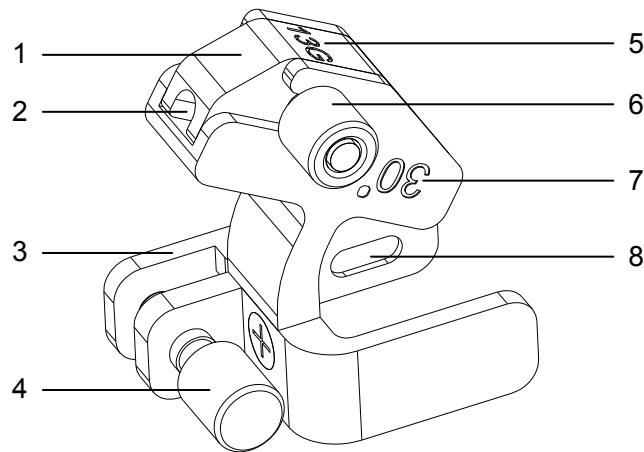

No.	Name	Description
1	Guiding block	Used for installing biopsy needle; there are five specifications of guiding blocks for different biopsy needles.
2	Guiding hole of the biopsy needle	Used for installing the biopsy needle.
3	Support of needle-guided bracket	Used for installing the needle-guided bracket on the probe.
4	Knob of fixing needle-guided bracket	Used for fixing the needle-guided bracket on the probe.
5	Specification of guiding block (13G)	Matched with the corresponding biopsy needle (13G).
6	Knob of fixing the guiding block	Used for fixing the guiding block.
7	Needle guide angle	The needle guide angle of this needle-guided bracket.
8	Grooves of the needle-guided bracket	Matched with the tabs of the probe.



■ NGB-011

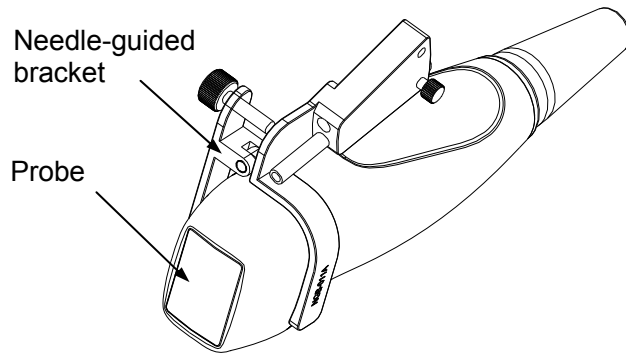
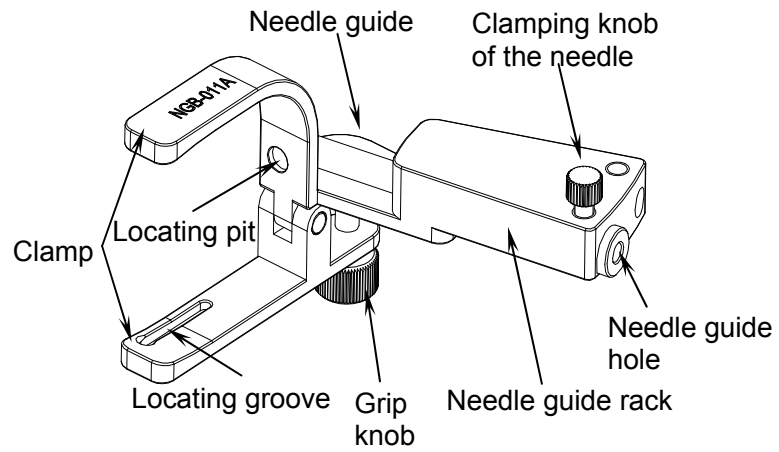

■ NGB-012

Metal/needle detachable needle-guided bracket:

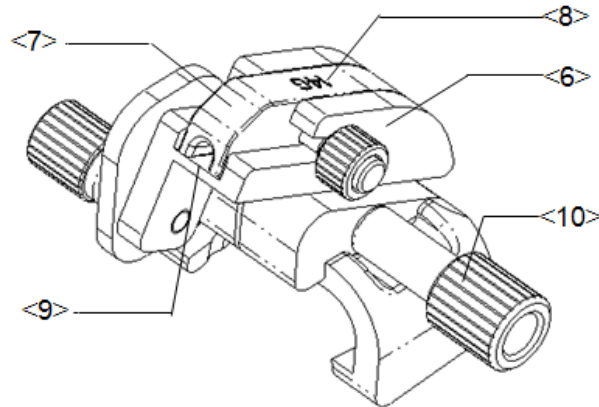

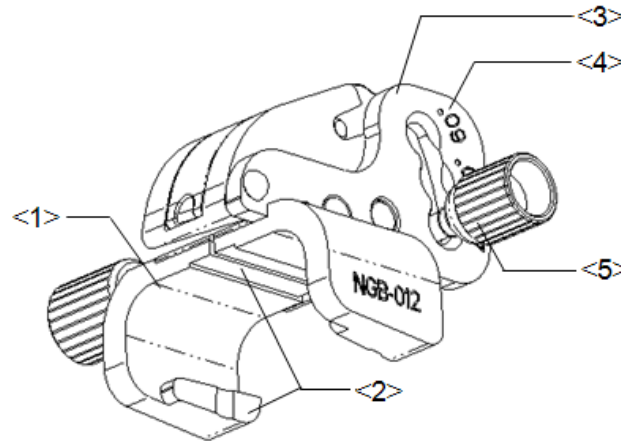

No.	Name	Description
<1>	Support of needle-guided bracket	Used for installing the needle-guided bracket on the transducer
<2>	Groove and tab of needle-guided bracket	Respectively matched with the tab and groove of the transducer
<3>	Angle adjusting base	There are 3 types of angles available to be adjusted
<4>	Angle shift sign(40°, 50°, 60°)	Matched with the biopsy angle (40°, 50°, 60°)
<5>	Angle pinch nut	Used for fixing the angle lock at a certain angle
<6>	Angle block	Used for determining the angle of the biopsy; different specifications of blocks can be used
<7>	Guiding block	Used for installing biopsy needle; there are five specifications of guiding blocks for different biopsy needles
<8>	Specification of guiding block (14G)	Matched with the corresponding biopsy needle (14G)
<9>	Needle guide hole	Used for installing the biopsy needle
<10>	Pinch nut of needle-guided bracket	Used for locking the needle-guided bracket and the transducer

Plastic/needle detachable needle-guided bracket:

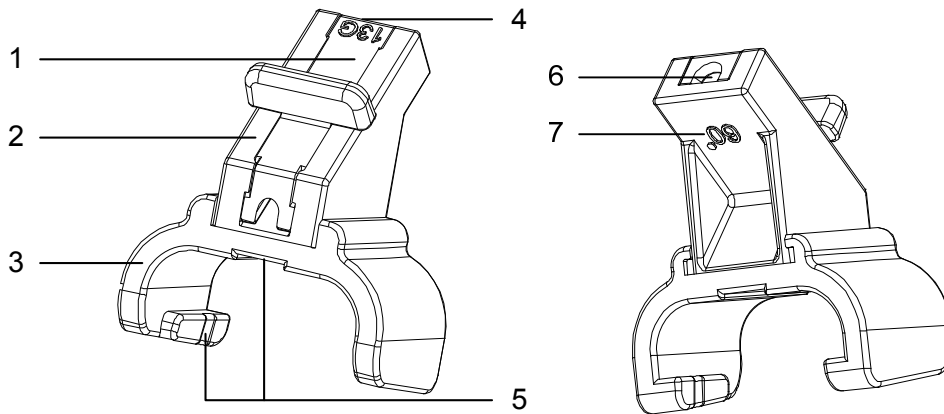

No.	Name	Description
<1>	Guiding block	Used for installing biopsy needle; there are five specifications of guiding blocks for different biopsy needles
<2>	Angle block	Used for determining the angle of the biopsy; there are three specifications of blocks of angle
<3>	Support of needle-guided bracket	Used for installing the needle-guided bracket on the transducer
<4>	Specification of guiding block (13G)	Matched with the corresponding biopsy needle (13G)
<5>	Groove and tab of the needle-guided bracket	Respectively matched with the tab and groove of the transducer
<6>	Needle guide hole	Used for installing the biopsy needle
<7>	Specification of angle block (60°)	Corresponding to the size of the biopsy angle (60°)

■ NGB-015

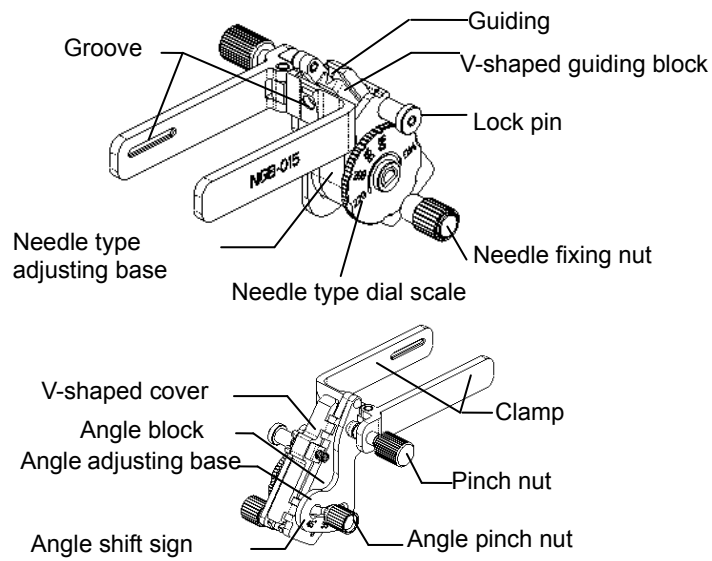

■ NGB-016

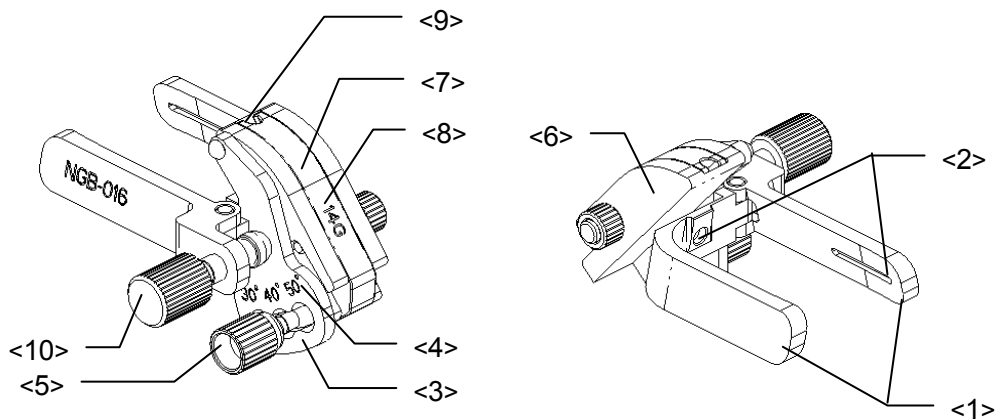

No.	Name	Description
<1>	Clamp of needle-guided bracket	Used for installing the needle-guided bracket on the probe.
<2>	Groove of the needle-guided bracket	Matches with the tab of the probe.
<3>	Angle adjusting base	There are 3 types of angles available to be adjusted.
<4>	Angle shift sign (30°, 40°, 50°)	Matches with the biopsy angle (30°, 40°, 50°).
<5>	Angle pinch nut	Used for fixing the angle lock at a chosen angle.
<6>	Angle block	Determines the angle of the biopsy; different specifications of blocks can be used.

No.	Name	Description
<7>	Guiding block	Used for installing the needles of different specifications, 5 types of needles are available.
<8>	Specification of guiding block (14G)	Matched with the corresponding biopsy needle (14G).
<9>	Guiding hole of biopsy needle	Used for installing the needles.
<10>	Pinch nut of needle-guided bracket	Used for locking the needle-guided bracket and the probe.

## 18.2.3 Needle-guided Bracket Inspection and Installation

### 18.2.3.1 Inspection of the Needle-guided Bracket

Be sure to perform inspections before and after use of the needle-guided bracket. If an abnormality is found on the needle-guided bracket, immediately stop using it and contact MINDRAY Customer Service Department or sales representative.

1. Sterilize the needle-guided bracket before and after use.
2. Confirm that the needle-guided bracket is free of damage, deformation, stripping, malfunction, loose, or missing parts.
3. Confirm that the needle-guided bracket is securely mounted in the correct position.

### 18.2.3.2 Installing the Needle-guided Bracket

#### ■ NGB-004

- (1) Put on the sterile probe sheath.

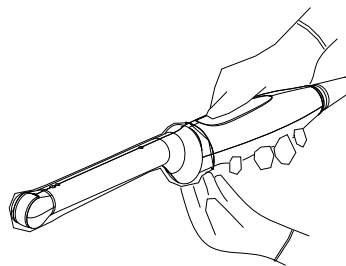

- (2) Open the retaining clamp, align the needle-guided bracket with the probe to locate the locating bulge on the needle guide to the locating grooves on the probe, and then turn the retaining clamp to match it with the probe (See the figure below).

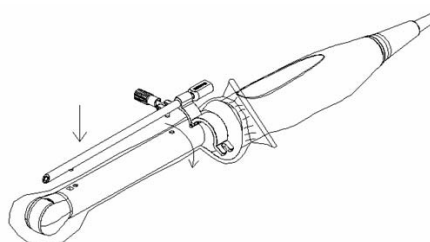

- (3) When the retaining clamp is turned to the right position, the locking nut will lock the retaining clamp and the needle-guided bracket is then mounted to the right position.

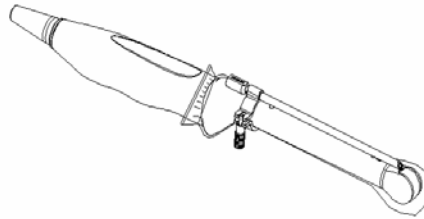

■ NGB-005

- (1) Inosculate the locating groove on the clamp with the two raised edges on the probe head and aligning the locating pit of the clamp to the convex point on the probe head.
- (2) Turn the grip knob at the tail of the needle-guided bracket tightly.

■ NGB-006

Metal needle-guided bracket:

- (1) Put on the sterile probe cover.
- (2) Hold the probe by one hand, select the proper needle-guided bracket, and hold it with the other hand. Match the groove and tab with the tab and groove of the probe respectively. Amount the bracket onto the probe.



- (3) Turn the pinch nut to secure the bracket and the probe.
- (4) Select a guiding block of proper size; slightly push it into the groove on the support.

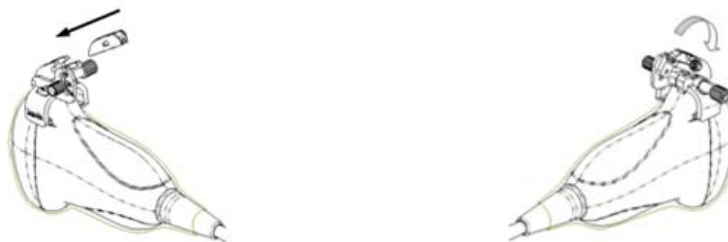

- (5) Screw the nut on the guiding block to secure the block and the needle-guided bracket.
- (6) Insert a biopsy needle with the same specification as that of the guiding block into the hole of the guiding block.

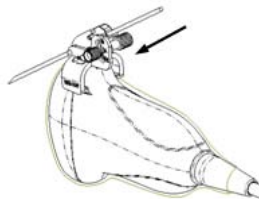

Plastic needle-guided bracket:

- (1) Put on the sterile probe sheath.
- (2) Hold the probe by one hand, select proper needle-guided bracket, and hold it with the other hand. Align the narrow end tab of the needle-guided bracket with the groove of the probe, then push the needle-guided bracket forward, making the tabs and the grooves of the needle-guided bracket to match with the grooves and tabs of the probe.

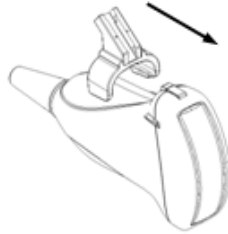

- (3) Check manually to confirm that the needle-guided bracket is securely installed on the probe.
- (4) Select a proper guiding block and push it into the groove above the angle block, and clamp it tightly.

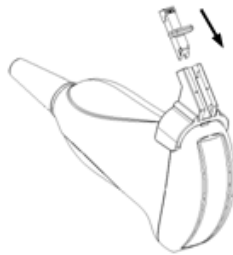

- (5) Insert a biopsy needle with the same specification as that of the guiding block into the hole of the guiding block.

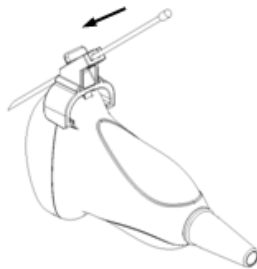

■ NGB-007 and NGB-012 (taking NGB-007 as example)

Metal/needle detachable needle-guided bracket:

- (1) Put on the sterile probe sheath.
- (2) Hold the probe by one hand, select the proper needle-guided bracket, and hold it with the other hand. Match the groove and tab with the tab and groove of the probe respectively. Amount the bracket onto the probe.

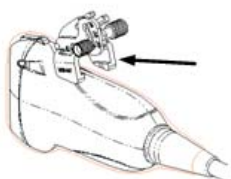

- (3) Screw the pinch nut of the needle-guided bracket to confirm that the needle-guided bracket is properly installed on the probe.
- (4) Select a proper guiding block and push it into the groove above the angle block, and clamp it tightly.



- (5) Screw the nut of the block to secure the block.
- (6) Insert a biopsy needle with the same specification as that of the guiding block into the hole of the guiding block.

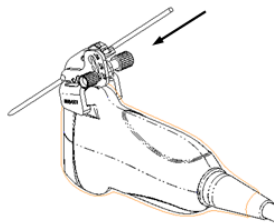

Plastic needle-guided bracket:

- (1) Put on the sterile probe sheath.
- (2) Hold the probe by one hand, select the proper needle-guided bracket, and hold it with the other hand. Align the narrow end tab of the needle-guided bracket with the groove of the probe, then push the needle-guided bracket forward, making the tabs and the grooves of the needle-guided bracket to match with the grooves and tabs of the probe.

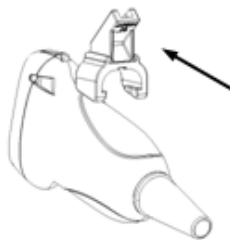

- (3) Check manually to confirm that the needle-guided bracket is securely installed on the probe.
- (4) Select a proper guiding block and push it into the groove above the angle block, and clamp it tightly.

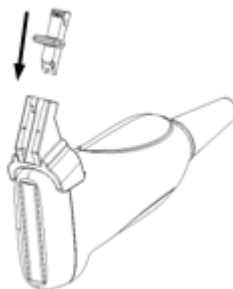



- (5) Insert a biopsy needle with the same specification as that of the guiding block into the hole of the guiding block.

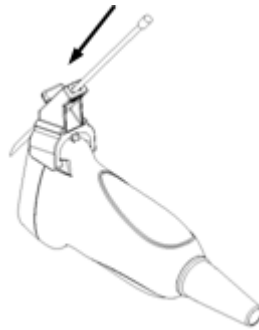

■ NGB-008

Metal/needle-detachable needle-guided bracket;

- (1) Put on the transducer cover.
- (2) Select a proper needle-guided bracket, and match the groove and tab with the tab and groove of the transducer respectively. Mount the bracket onto the transducer.



- (3) Screw the pinch nut of the needle-guided bracket to confirm that the needle-guided bracket is properly installed on the transducer.
- (4) Select a proper guiding block and push it into the groove above the angle block.



- (5) Screw the nut of the block to secure the block.
- (6) Insert a biopsy needle with the same specification as that of the guiding block into the hole of the guiding block.

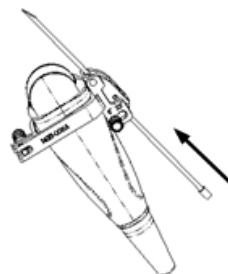

Plastic/needle-detachable needle-guided bracket:

- (1) Put on the transducer cover.
- (2) Hold the transducer by one hand, select proper needle-guided bracket, and hold it with the other hand, and align the tab of the needle-guided bracket with the groove

of the transducer, then push the needle-guided bracket along the arrow, making the tab of the needle-guided bracket to match with the groove of the transducer.

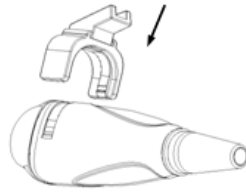

- (3) Check manually to confirm that the needle-guided bracket is securely installed on the transducer.
- (4) Select a proper guiding block and push it into the groove above the angle block, and clamp it tightly.

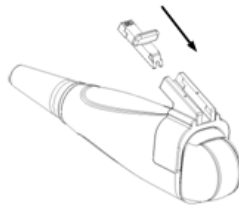

- (5) Insert a biopsy needle with the same specification as that of the guiding block into the hole of the guiding block.

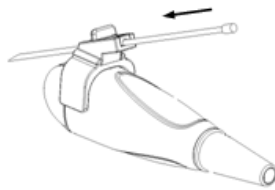

■ NGB-009 metal/needle detachable needle-guided bracket

- (1) Put on the transducer cover.

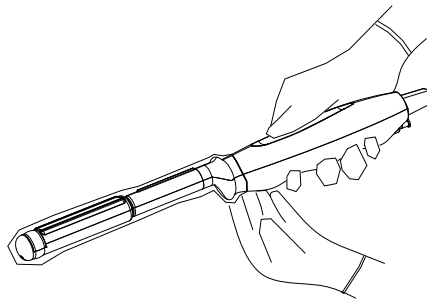

- (2) Cover the support of needle-guided bracket on the transducer, making the groove of the needle-guided bracket to match with the tab of the transducer. Set the needle-guided bracket at the desired position, turn tightly the knob of fixing needle-guided bracket to fix the needle-guided bracket.

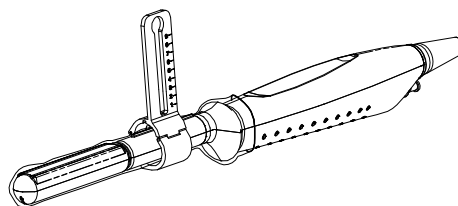

- (3) Select a proper guiding block and thread the knob of fixing the guiding block through the hole of installing guiding block, move the guiding block to the desired position, then turn tightly the knob of fixing the guiding block to fix the guiding block on the support of needle-guided bracket.

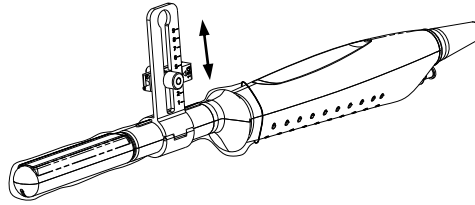

- (4) Insert a biopsy needle with the same specification as that of the guiding block into the hole of the guiding block and turn tightly the knob of fixing the needle.

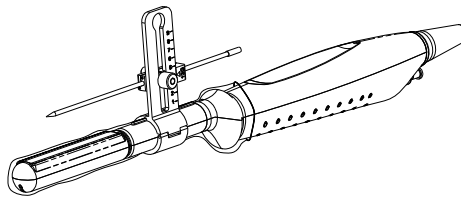

■ NGB-010 metal/needle detachable needle-guided bracket

- (1) Put on the probe cover.
- (2) Hold the probe by one hand, select proper needle-guided bracket, and hold it with the other hand, and align the grooves of the needle-guided bracket with the tabs of the probe, then push the needle-guided bracket forward, making the grooves of the needle-guided bracket to match with the tabs of the probe. Set the needle-guided bracket at the desired position, turn tightly the knob of fixing needle-guided bracket to fix the needle-guided bracket.

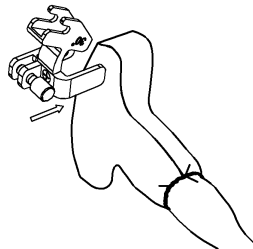

- (3) Check manually to confirm the needle-guided bracket is securely installed on the probe.
- (4) Select a proper guiding block and push it into the groove above the support of needle-guided bracket, then turn tightly the knob of fixing the guiding block to fix the guiding block on the support of needle-guided bracket.



- (5) Insert a biopsy needle with the same specification as that of the guiding block into the hole of the guiding block.

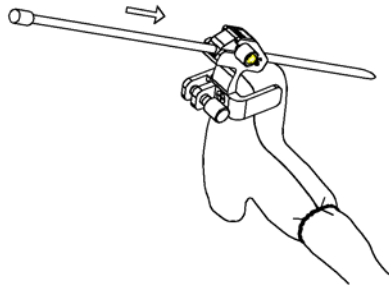

■ NGB-011

- (1) Inosculate the locating groove on the clamp with the two raised edges on the probe head and align the locating pit of the clamp to the convex point on the probe head.
- (2) Turn the grip knob at the tail of the needle-guided bracket tightly.

■ NGB-015

- (1) Put on the sterile transducer sheath.
- (2) Hold the transducer by one hand, select the proper needle-guided bracket, and hold it with the other hand. Match the groove of the bracket with the tab of the transducer. Amount the bracket onto the transducer.

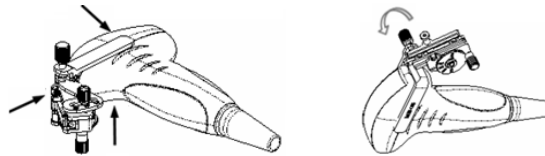

- (3) Screw the pinch nut of the needle-guided bracket to confirm that the needle-guided bracket is properly installed on the transducer.
- (4) Adjust the dial scale to the required needle type shift, and then screw the needle fixing nut to lock the dial scale. (To adjust the dial scale you have to loose the needle fixing nut first.)
- (5) Pull the lock pin and close the V-shaped cover to fix the lock pin in the groove of the needle type adjusting base, so as to install the needle into the guiding hole.

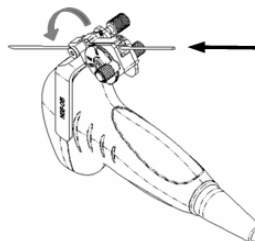

■ NGB-016

- (1) Put on the probe sheath.
- (2) Select a proper needle-guided bracket, and match the groove with the tab of the probe. Mount the bracket onto the probe.



- (3) Screw the pinch nut of the needle-guided bracket to confirm that the needle-guided bracket is properly installed on the probe.
- (4) Select the appropriate guiding block, and fit it into the groove on the angle block.



- (5) Screw the nut on the guiding block to secure the guiding block with the needle-guided bracket.
- (6) Insert the needle of the same specification with that of the guiding block into the guiding hole.

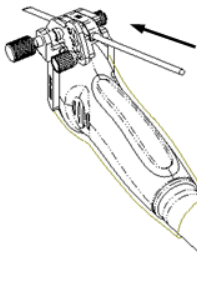

**⚠ CAUTION:** Ensure that all guide parts are seated properly prior to performing a biopsy.

### 18.2.4 Entering or Exiting Biopsy Menu

To enter the biopsy:

- 1 Press the [Biopsy] key on the control panel, and the screen displays “Please verify guidelines before biopsy”. Click [OK] to show the biopsy guide line.
- 2 Press the [Menu] key to show the image menu, and move the cursor onto the menu title and click Biopsy in the pop-up menu. A screen will open as shown in the figure below.

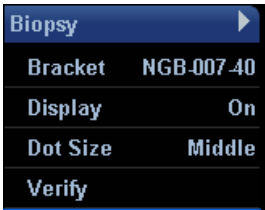

**To exit the biopsy:**

- 1 Press the [Esc] key. Or
- 2 Move the cursor onto the Biopsy menu title and navigate to select other menus in the pop-up menu.

**⚠ WARNING:** Do not freeze an image while performing biopsy procedure.

## 18.2.5 Displaying Biopsy Guide Lines

- 1 Select biopsy bracket angle.  
Select the biopsy bracket angle (by changing the last two digits of the parameter value) on the bracket selection.
- 2 Display or hide the guide line,
  - a) To display the guide line, turn on [Display].
  - b) To hide the guide line, turn off [Display].
- 3 Select guide line dot size.  
Roll the trackball to move the cursor on [Dot Size], and press [Set] key or [Back] key to cycle through [Large], [Middle], and [Small].

## 18.2.6 Verifying the Biopsy Guide Line

**⚠ WARNING:**

- 1 Prior to each biopsy procedure, be sure to verify the guide line.
- 2 If the needle is not consistent with the guide line, do not perform the biopsy procedure.

**NOTE:** The B-Mode image must be live and active to verify the onscreen biopsy guideline.

It is recommended to verify the needle path against the biopsy bracket in a sterile container and sterile water solution.

Click [Verify] in the Biopsy menu to open the [Biopsy Verify] menu.

Biopsy Verify	
Position	-56
Angle	-76
Save	
Load Factory	
Exit	

### ■ Adjust position

Changing the position value can move the biopsy guide line horizontally.

- 1) Press [Set] to increase the position value.
- 2) Press [Back] to decrease the position value.
- 3) Or rotate the [Multifunction] knob to increase or decrease the position value.

### ■ Adjust angle

The method for adjusting guide line angle is the same to that for adjusting guide line position.

### ■ Save verified settings

After the position and angle of the guide line are adjusted, click [Save], and the system will save the current settings of the guide line.

**NOTE:** When the system is restarted, the biopsy guide lines **will not be restored to factory default positions.** Altered biopsy guide line positions must be restored back to factory defaults.

### ■ Restore the factory default settings

Click [Load Factory], and the position and angle of the guide line will be restored to the factory default settings.

### ■ Exit the Biopsy Verify status

Click [Exit], and the system will exit the verification status of the guide line.

## 18.2.7 Removing the Needle-guided Bracket

### ■ NGB-004

Hold the probe in the left hand, unscrew the locking nut with the right hand to open the retaining clamp, and then raise the needle-guided bracket to separate the locating bulge from the locating grooves.

### ■ NGB-005

Hold the probe and the needle-guided bracket; open the grip knob of the needle-guided bracket.

### ■ NGB-006

Metal needle-guided bracket:

- (1) Screw out the nut on the guiding block to loose the guiding block and the needle-guided bracket.



- (2) Take the guiding block away in the direction of the needle tail, and then separate the needle from the probe and the residual parts of the needle-guided bracket.
- (3) Screw out the locking nut on the needle-guided bracket to loose the bracket with the probe.



- (4) Hold the probe with one hand, and then separate the needle-guided bracket from the probe.

Plastic needle-guided bracket:

- (1) Remove the guiding block slightly along the direction of the needle's tail.
- (2) Separate the residual part of the needle-guide bracket and the probe from the needle.

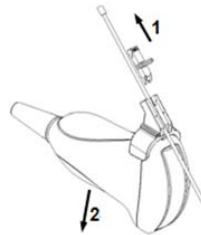

- (3) Remove the support of needle-guided bracket from the probe.



#### ■ NGB-007

Metal needle-guided bracket:

- (1) Screw the nut of the guiding block and remove the guiding block slightly along the direction of the needle's tail.
- (2) Separate the residual part of the needle-guide bracket and the probe from the needle.
- (3) Screw the pinch nut of the bracket, and remove the needle-guided bracket from the probe.

Plastic needle-guided bracket:

- (1) Remove the guiding block slightly along the direction of the needle's tail.
- (2) Separate the residual part of the needle-guide bracket and the probe from the needle.
- (3) Remove the support of needle-guided bracket from the probe.

#### ■ NGB-008

Metal/needle-detachable needle-guided bracket;

- (1) Screw the nut of the guiding block and remove the guiding block slightly along the direction of the needle's tail.
- (2) Separate the residual part of the needle-guide bracket and the transducer from the needle.
- (3) Screw the pinch nut of the bracket, and remove the needle-guided bracket from the transducer.



Plastic/needle-detachable needle-guided bracket;

- (1) Remove the guiding block slightly along the direction of the needle's tail.
- (2) Separate the residual part of the needle-guide bracket and the transducer from the needle.
- (3) Remove the support of needle-guided bracket from the transducer.

■ NGB-009

- (1) Turn on the knob of fixing the needle and separate the needle from the needle-guided bracket.
- (2) Turn on the knob of fixing guiding block and remove the guiding block from the hole of installing guiding block.
- (3) Turn on the knob of fixing needle-guided bracket and remove the needle-guided bracket.

■ NGB-010

- (1) Remove the guiding block slightly along the direction of the needle's tail, and separate the residual part of the needle-guide bracket and the probe from the needle.
- (2) Remove the support of needle-guided bracket from the probe.

■ NGB-011

Hold the probe and the needle-guided bracket, and then open the grip knob of the needle-guided bracket.

■ NGB-012

Metal/needle detachable needle-guided bracket:

- (1) Screw the nut of the guiding block and remove the guiding block slightly along the direction of the needle's tail.

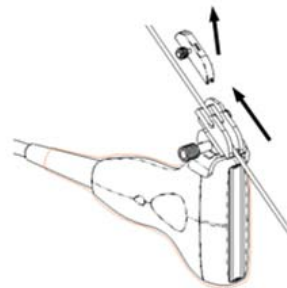
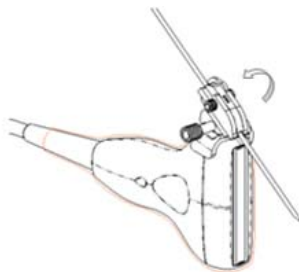

- (2) Separate the residual part of the needle-guide bracket and the transducer from the needle.
- (3) Screw the pinch nut of the bracket, and remove the needle-guided bracket from the transducer.

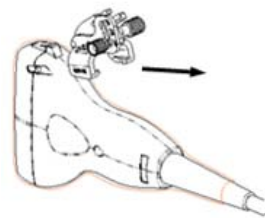
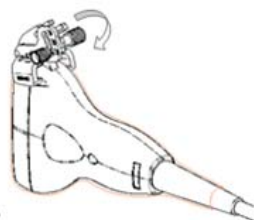

Plastic/needle detachable needle-guided bracket:

- (1) Remove the guiding block slightly along the direction of the needle's tail.

- (2) Separate the residual part of the needle-guide bracket and the transducer from the needle.
- (3) Remove the support of needle-guided bracket from the transducer.

■ NGB-015

- (1) Pull the lock pin and open up the V-shaped cover to expose the needle.

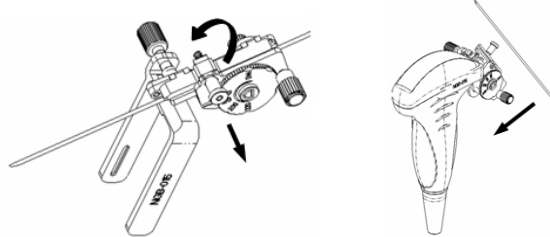

- (2) Separate the bracket and the transducer from the needle.
- (3) Screw the pinch nut to release the needle-guided bracket.

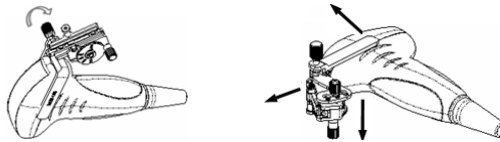

- (4) Separate the bracket and the transducer.

■ NGB-016

- (1) Screw out the nut on the on the guiding block to release the biopsy needle.



- (2) Remove the guiding block in the direction of the needle tail, and then remove the needle.
- (3) Screw the pinch nut of the bracket to release the needle-guided bracket.



- (4) Separate the probe and the needle-guided bracket.

## 18.2.8 Clean and Sterilize the Needle-guided Bracket

### Cleaning

1. Wear sterile gloves to prevent infection.
2. Wash the needle-guided bracket with water or soap water to remove all the external matters. Or, clean the needle-guided bracket with urethane sponge.
3. Wipe off the water on the needle-guided bracket using sterile cloth or gauze after washing it.

### Sterilization

1. Wear sterile gloves to prevent infection.
2. Clean the needle-guided bracket before sterilizing it. MINDRAY recommends the following solution or sterilizing system to sterilize the needle-guided bracket.
3. Follow local regulations when selecting and using the disinfectant.

■ Glutaraldehyde-based disinfectant:

Chemical name	Trade name	Procedures
Glutaraldehyde (2.2-2.7%)	Cidex Activated Glutaraldehyde Solution (applicable for CE region)	Please refer to the instructions provided by the manufacturer of the solution for details.  It may require 10 hours to 14 days submersion at 25°C.
Glutaraldehyde (2.4%)	Cidex Activated Dialdehyde Solution (applicable for FDA region)	

- Refer to the instructions provided by the chemical manufacturer concerning concentration of the solution, and method of disinfections and dilution. Note that the glutaraldehyde disinfectant solution needs an activating solution.
- Rinse the needle-guided bracket thoroughly with sterile water to remove all chemical residues on it.
- Wipe off the water on the needle-guided bracket with sterile cloth or gauze after rinsing it.

■ N-Dodecylpropane-1, 3-diamine based disinfectant:

Chemical Name	Manufacturer	Trade Name	Procedures
N-Dodecyl- propane-1, 3-diamine	Antiseptica	Triacid-N	Please refer to the instructions provided by the manufacturer of the solution for details.

■ Quaternary Ammoniums based disinfectant:

Chemical Name	Manufacturer	Trade Name	Procedures
Quaternary Ammoniums	Ecolab Inc.	Ster-Bac	Please refer to the instructions provided by the manufacturer of the solution for details.

■ Hydrogen Peroxide and Peroxyacetic Acid -based disinfectant:

Trade Name	Chemical Name	Procedures
Minnicare® Cold Sterilant	22% Hydrogen Peroxide 4.5% Peroxyacetic Acid	Please refer to the instructions provided by the manufacturer of the solution for details.

■ STERRAD 100S low-temperature hydrogen peroxide gas plasma sterilization system

Chemical name	Trade name	Procedures
Hydrogen peroxide gas plasma	Hydrogen peroxide vapor	Please refer to the instructions provided by the producer of the solution for details.

- Refer to the instruction of STERRAD 100S sterilizing system provided by the manufacturer for operation instructions and cautions.

**NOTE:** Repeated sterilization may degrade the safety and performance of the needle-guided bracket.

## 18.2.9 Storage and Transportation

1. Don't use the carrying case for storing the needle-guided bracket. If the carrying case is used for storage, it may become a source of infection.
2. Between examinations, keep the needle-guided bracket in a sterile environment.
3. When the needle-guided bracket is sent to your MINDRAY representative for repair, be sure to disinfect or sterilize it and keep it in the carrying case to prevent infection.
4. Sterilize the carrying case as necessary.
5. Store or transport the needle-guided bracket under the following ambient conditions:
  - Ambient temperature: -20°C to 55°C
  - Relative humidity: 30% to 85% (no condensation)

## 18.2.10 Disposal

Be sure to dispose the needle-guided bracket only after sterilizing it.  
Contact your MINDRAY representative when disposing of this device.

# 19 ECG

---

The system can be configured with the optional ECG module. In that case, the ECG signal is displayed on the image, and can be reviewed simultaneously with the image after the image is frozen.

- |                   |          |  |
|-------------------|----------|--|
| <b>⚠ WARNING:</b> | <b>1</b> | <b>To avoid electric shock, the following checks shall be performed prior to an operation:</b><br>a) The ECG electrode cable shall not be cracked, frayed or show any signs of damage or strain.<br>b) The ECG electrode cable shall be correctly connected.<br>c) You should use the ECG leads provided with the ECG module. Otherwise it may result in electric shock. |
|                   | <b>2</b> | <b>The ECG electrode cable must be connected to the system first.</b>  |
|                   | <b>3</b> | <b>Only after the cable is connected to the system, can the animal be connected to the ECG electrodes. Failure to follow these instructions may subject the animal to electric shock.</b>  |
|                   | <b>4</b> | <b>Do not place the ECG electrodes directly in contact the animal's heart; otherwise it may lead to stop of the animal's heartbeat.</b>  |
|                   | <b>5</b> | <b>Do not apply the ECG electrodes if the voltage exceeds 15 volts. This could produce an electric shock.</b>  |
|                   | <b>6</b> | <b>Before using high frequency electric surgical unit, high frequency therapeutic equipment or defibrillator, be sure to remove the ECG electrode from the animal, in order to prevent electric shock.</b>   |
|                   | <b>7</b> | <b>Conductive parts of electrodes and associated connectors for ECG should not contact other conductive parts including earth / grounding.</b>   |

## 19.1 ECG Connection

The ECG connection shall be performed in the following procedure:

- 1 Turn off the power supply of the system, and connect the ECG module to the USB port of the system;
- 2 Connect the ECG cable to the ECG port of the ECG module;
- 3 Turn on the power supply of the system;
- 4 Place the ECG electrodes on the animal's body (as shown in the following figures).

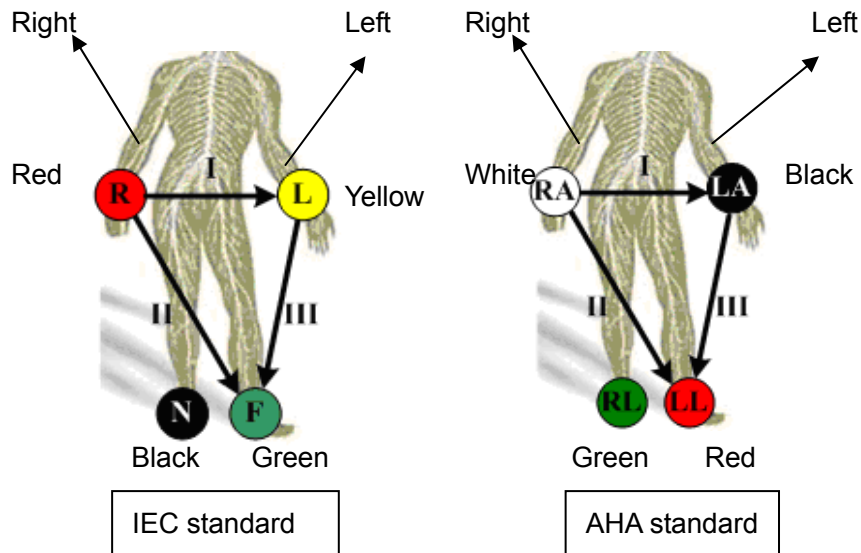

## 19.2 Displaying ECG Signal

To display ECG signal, press the ECG user-defined key on the control panel, or select ECG through the menu title to enter the ECG menu.

### ECG Display

Select [Display On] in the ECG menu to display the ECG waveform.

### ECG Position

Select [ECG Position] in the ECG menu to change the baseline position of ECG waveform.

### ECG Gain

Select [ECG Gain] in the ECG menu to control the amplitude of ECG waveform.

## 19.3 ECG Triggering

### 19.3.1 ECG Triggering

ECG triggering means that image scanning is activated at some time points of ECG signals, thus obtaining B images at these time points.

When ECG triggering occurs, some marks appear on the ECG waveform, indicating the time points when the B images are captured.

### 19.3.2 Triggering Mode

In the ECG menu, move the cursor onto [Trig Mode] to turn it on and then select the triggering mode among selections Single, Dual, AT and Timer and set the delay time T1 and T2.

- Single Trigger: When an R waveform is detected, an image will be triggered after delay time T1 (set in the ECG menu).
- Dual Trigger: When an R waveform is detected, two images in two windows will be triggered respectively after delay time T1 and T2 (set in the ECG menu).
- Timer Trigger: An image will be triggered after a time interval (set in the ECG menu).
- AT: The AT delay time is set through the path: Setup → Image Preset → ECG.

### 19.3.3 Real & Trigger

The Real & Trigger feature is valid for Single, AT and Timer triggering modes. Move the cursor onto [Real & Trigger] in the ECG menu to turn it on or off.

After the [Real & Trigger] is turned on, two images are displayed respectively in two windows, one is triggered by ECG, and the other is real time image. After [Real & Trigger] is turned off, only the image triggered by ECG is displayed.

## 19.4 ECG Review

When an image is frozen, the ECG waveform where the image is triggered will be frozen at the same time. In the Dual triggering mode, the two window images are frozen at the same time. When images are reviewed with the ECG electrodes connected, the ECG waveform is the reference for time.

After the images are frozen, all real time images are in the status of linked review.

## 19.5 Exiting ECG

In the ECG mode, move the cursor onto [Display] to turn it off in the ECG menu, and the ECG waveform disappears and the system exits the ECG mode.

## 19.6 Setting ECG

You can set up ECG parameters through the path: Setup → Image Preset → ECG page.  
See the figure below.

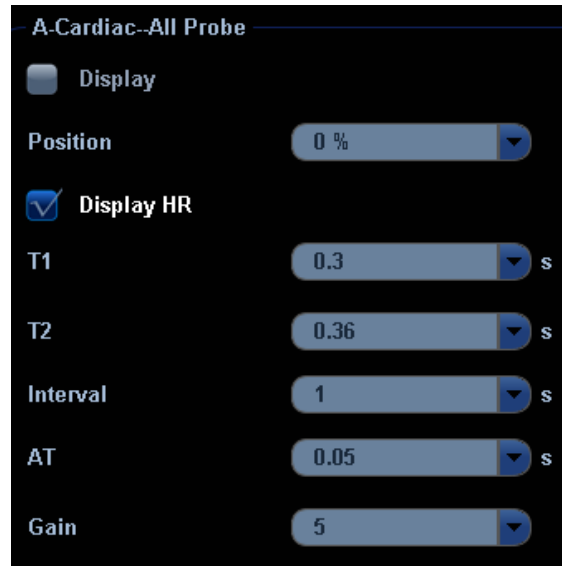



# 20 Image Recording

---

## 20.1 VCR (Video Cassette Recorder)

VCR is used to record and replay exam images. The storage medium for VCR is cassette.

**NOTE:**

- 1 Strictly observe the procedures described here to perform the recording and replaying operations of VCR; otherwise it may result in data loss or system malfunction.
- 2 Set the PAL or NTSC in the setup and this shall be consistent with that in the VCR.
- 3 Accidental exposure to strong electromagnetic fields or mishandling of the video cassette may result in image and data loss, so check if the recording is successful as soon as possible. Mindray is not responsible for any data loss.

### 20.1.1 Setup

To set the following parameters before using VCR:

- 1 The setting path is: [Setup] → [Peripheral Preset] → [Recorder]. Select VCR in the Current Recorder drop-down list, and select Serial Baud Rate in the VCR setting field (Note: The set Baud rate shall be identical to that of the VCR recorder. It is recommended to set the value of Baud Rate as [9600]).
- 2 You can define a key to use VCR through the following path: [Setup] → [System Preset] → [Key Config]. Select a key in the Key page or Footswitch page on the left side and select Record or Video (for replay) in the Other page on the right side.

### 20.1.2 Record

- **VCR Record Icons**



: In the pause status, click this icon to restart the VCR recording.



: In the record status, click this icon to pause the VCR recording.



: Click this icon to stop recording.



: This icon indicates error status for recording.

**● To record:**

- 1 Connect the VCR recorder to the ultrasound system and put a cassette in the recorder.
- 2 Set the VCR recorder through the following path: [Setup] → [Peripheral Preset]→ [Recorder].
- 3 Start the ultrasound exam and acquire images.
- 4
  - Press the user-defined key (preset in the [Key Config] screen) on the control panel.  
Or
  - Move the cursor onto the menu title to navigate to the VCR Record selection and press [Set] to show the VCR Record menu. Or
  - Click  icon in the lower right corner of the screen.
- 5 Move the cursor onto Record / Pause selection and press [Set] to enter VCR recording status and record images.
- 6 Press the user-defined VCR record key a second time, or move the cursor onto Record / Pause selection and press Set, to stop recording.
- 7 Repeat the steps 3 through 6 as needed to record multiple segments of images.
- 8 Press [Stop Record] in the VCR Record menu to stop recording.
- 9 Press [Eject] to remove the VCR cassette.

**NOTE:**

After the cassette has recorded data and been taken out / re-inserted, you will need to select [blank search] from the front of the VCR to find the next blank tape position. Subsequent recording can overwrite existing data.







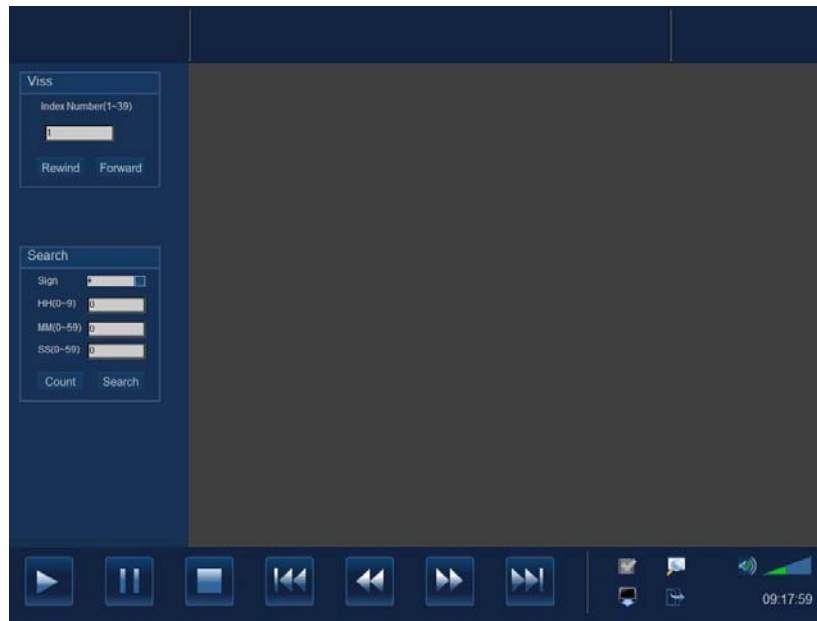







### 20.1.3 Replay

**To replay the recorded images using VCR:**

- 1 Connect the VCR recorder to the system and place the cassette with recorded data.
- 2 Press the user-defined key for VCR replay on the control panel, or move the cursor onto the menu title to navigate to the Other selection and press [Set] to show the Other menu. Select Video in the Other menu and press [Set] to enter the VCR replay. The screen displays the following screen.



- 1) The buttons at the bottom of the screen are used to control replay. Their functions are described as follows:

	Play		Viss Mark; to add segment mark in the current position.
	Pause		Search blank.
	Stop		Stop VCR replay (but still in VCR replay mode) and eject the cassette.
	Previous segment		Exit the VCR replay mode.
	Rewind		Sound.
	Fast forward		Mute.
	Next segment		Adjust volume.

- 2) The functions of Viss and Search are available on the left side of the image review area.

Viss:

Enter one of numerals (1~39) for Index Number;

[Rewind]: press it to search and find the corresponding Viss mark by rewinding the cassette;

[Fast Forward]: press it to search and find the corresponding Viss mark by forwarding the cassette.

Search:

Select “-” or “+” from the Sign’s drop-down menu; “-” refers to rewind; “+” refers to forward.

Enter time and press [Search] to search and move to the appointed position.

Enter time and press [Count] to set the current VCR counter.

3

Exit the VCR replay status, click  in the lower right corner of the screen, or press the user-defined VCR replay key.

## 20.2 DVR (Digital Video Recorder)

You can use the DVR recorder to record and replay videos and audios stored in DVD disc or hard disc.

### 20.2.1 Setup

To set up DVR settings, the path is the [Setup] → [Peripheral Preset] → [Recorder] → DVR Settings. Refer to “17.9 Peripheral Setup” for details.

Note: After resetting the DVR parameters, you need to restart the DVR recorder.

### 20.2.2 Entering/Exiting DVR

- Entering DVR

Move the cursor to the menu title, and select [DVR Record] or click  to enter the record menu. See the following figure.



- Function of the menu items

Items	Function
Record	Click to start to record
Pause	Click to temporarily stop the recording
Stop	Click to stop recording
Tray (Open/Close)	Click to open/close the DVD tray
Record Media	Click to select the storage medium for recording
DVR Data Management	Click to enter the data management operation
Video	Click to enter the video replaying screen
Exit	Click to exit DVR menu

- **Exiting DVR**

Click [Exit] in the [DVR Record] menu to exit the DVR operation.

## 20.2.3 Record

Recording is to record videos/audios obtained from the examination and to store them into DVD or hard disc of the DVR recorder.

- **Preparation before recording**

- 1 Connect the DVR recorder to the ultrasound system and ensure the DVD disc is put in the tray and there is adequate storage capacity in the hard disc.
- 2 The setting path is: Setup → Peripheral → Recorder; select [DVR] in the [Current Record] drop-down list.

- **Basic Operations**

- 1 Start the ultrasound exam and obtain images.
2. To record:
  - Click [Record] in the [DVR Record] menu. Or
  - Press [Record] button on the DVR recorder control panel. Or
  - Press [▶] button on the remote control.
3. To pause:
  - Click [Pause] in the [DVR Record] menu. Or
  - Press the [Pause] button on the DVR recorder control panel. Or
  - Press [⏸] key on the remote control.
4. To continue to record after pause:

Click [Record] item a second time in the [DVR Record] menu. See the following figure.



5. To stop:
  - Click [Stop] item in the [DVR Record] menu. Or
  - Press [Stop] button on the DVR recorder control panel. Or

- Press [■] key on the remote control. Or
- When a new exam is started or [End Exam] key is pressed to stop the current exam, the recording is stopped at the same time.

## 20.2.4 Data Management

Data management function offers advanced processing and edit to the data stored in DVD or HDD (Hard disc driver), including title naming/ exporting, DVD naming/ erasing/ importing etc.

- Entering/Exiting

To enter the DVR data management screen, click [Data Manage] in the [DVD Record] menu.

To exit the DVR data management screen, click [Exit] button on the [DVD Data Manage] or [HDD Data Manage] screen.

- DVD Data Management

DVD Data management contains title management and DVD disc management, as shown in the following figure. The progress bar indicates the proportion of occupied storage to the whole storage.

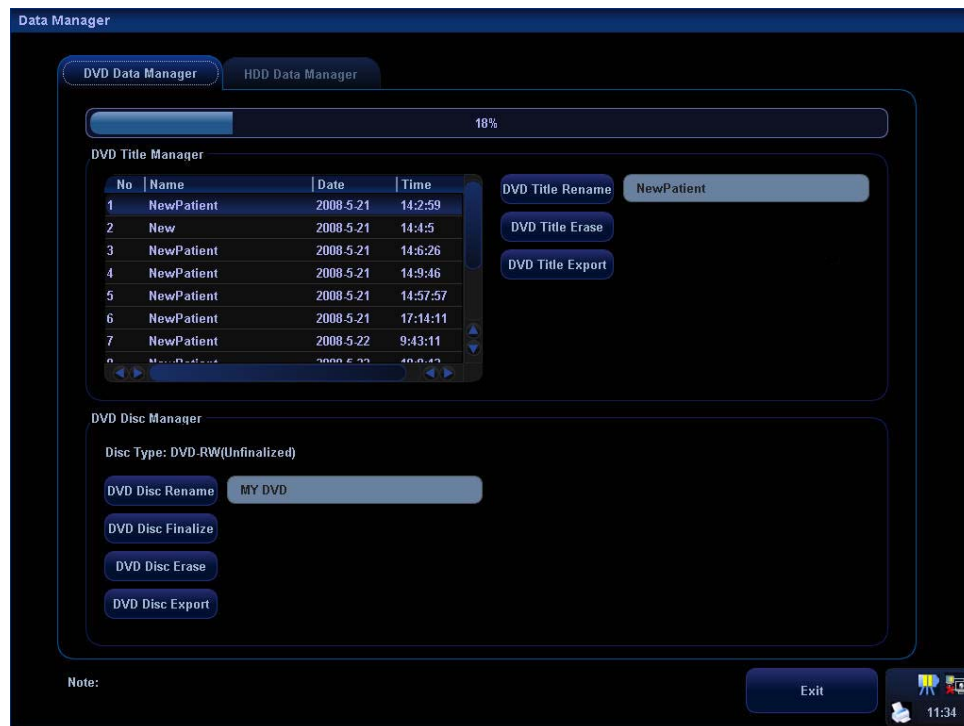

**To edit the recorded titles:**



Click to enter the user-defined name for selected record in the text area on the right side.



Click to delete the title of selected record.



Click to export selected record on DVD to the hard disc.

- DVD Management:

**DVD Disc Rename**

Click to enter the user-defined name for the DVD in the text area on the right side.

**DVD Disc Finalize**

Click to finalize the DVD.

**DVD Disc Erase**

Click to erase all data on the DVD.

**DVD Disc Export**

Click to export all data on the DVD to hard disc.

- **HDD (Hard disc drive) Data Management**

HDD data management contains renaming, deleting or exporting of a single record. As shown in the following figure, the progress bar indicates the proportion of occupied storage to the whole storage with a record list on the left side.

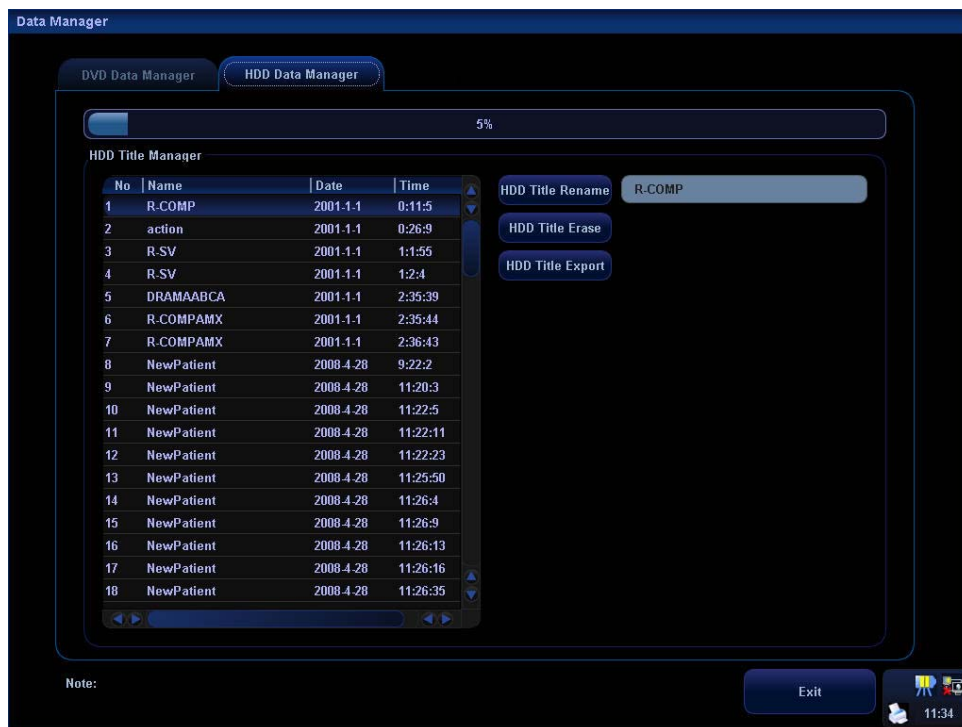
**HDD Title Rename**

Click to enter the user-defined name for selected HDD record in the text area on the right side.

**HDD Title Erase**

Click to delete the title of selected record.

**HDD Title Export**

Click to export selected record on the hard disc to DVD.

## 20.2.5 Video Replay

You can replay the video and audio record. The replay screen is shown in the following figure (Take HDD as an example).

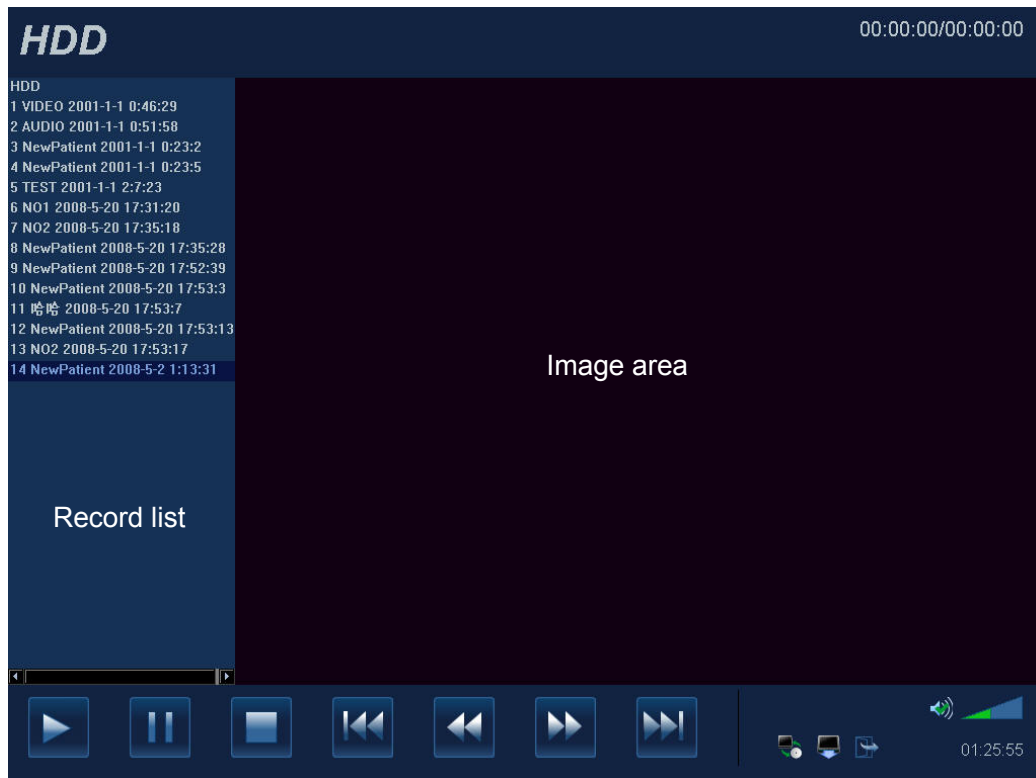

- Entering/Exiting

**To enter the replay screen:**

- 1) Click [Record Media] in the [DVR Record] menu to select storage medium.
- 2) Click [Video].

To exit the replay screen, click  in the lower part of the replay window.

- Preparation before replay

- 1
  - Connect the DVR recorder to the ultrasound system.
  - Select [DVR] in the [Current Record] drop-down list.
- 2 To select a medium for storage:
  - Press the [HDD/DISC] key on the DVR recorder control panel. Or
  - Press [DVD] or [HDD] key on the remote control. Or
  - Click  in the lower part of the replay screen.

- Basic Replay Operations:

- 1 To start video replay, click [Video] in the [DVD Record] menu.
- 2
  - Select desired record in the left record list.
  - Click  to replay a recorded segment.



- Function of replay operations are listed in the following table.

	Play		Next segment
	Pause		Open/Close tray
	Stop the replaying		Exit the replay status
	Previous segment		Sound
	Fast backward		Mute
	Fast forward		Adjust volume

### 3 Search Title/Chapter:

A chapter marker will be automatically inserted by the recorder each time when a record pauses. During the replaying, you can skip to specified title/chapter by selecting the title/chapter number. See the Operator's Manual of DVR recorder for details.

## 20.3 Non-programmable Record and Replay

This function is achieved by controls of the recorder itself without operations on the ultrasound system.

Settings:

- 1 Enter the setting page in ultrasound system: <Setup> - [Peripheral Preset] - [Recorder].
- 2 Select "None" in the Current recorder drop-down list
- 3 Other setting items are the same as mentioned before.

For details about recorder operation, please refer to the manuals provided by recorder manufacturer.

# 21 Batteries

---

## 21.1 Overview

The battery charges when the system is connected to the AC power supply.

- If the system is turned off; a completely discharged battery will fully charge in 2 to 3 hours; or generally a battery has been charged for 2 hours, it can restore the quantity of electric charge to above 95%.
- If the system is turned on; a completely discharged battery will fully charge in 14 hours.

**NOTE:** It is recommended to charge the batteries when the system is turned off, thus you can quickly charge the batteries and save time.

When the external power supply is not connected, two lithium-ion batteries will provide the power.

The model of the chargeable lithium-ion batteries (hereinafter called batteries for short) is LI23I001A.

**NOTE:**

- 1 Only use the specified batteries.
- 2 Charge the batteries periodically if they have not been used for a long period of time. Otherwise, the performance of the batteries is degraded.
- 3 If there is only one battery in the system, it cannot supply power and cannot be charged.
- 4 Replace both batteries at the same time.

## 21.2 Precautions

You shall observe the following precautions:

- 1 Before using the batteries, carefully read the description in the label on the surface of the batteries.
- 2 When you use the batteries at the first time and find that they are dirty or emit an odor, do not use them.
- 3 Do not expose the batteries to heat sources or high pressure.
- 4 Do not knock the batteries.

- 5 Do not leave the batteries in direct sunlight.
- 6 The batteries are designed to be charged only in this system; charge the batteries only when the ambient temperature is between 0 and 40 °C.
- 7 Store the batteries out of the reach of children.
- 8 When the batteries are out of power, please charge them immediately.
- 9 When the batteries will not be used for 10 days or over, take them out of the system and store the batteries with caution. Do not wrap them with conductive material; store them in shady, cool and dry place.

 <b>WARNING:</b>	1	<b>The batteries have protective mechanism and circuit. Do not disassemble or alter the battery.</b>
	2	<b>Do not short-circuit the batteries by directly connecting the negative terminals with metal objects.</b>
	3	<b>Do not heat the battery or discard it in a fire.</b>
	4	<b>Keep the batteries away from fire and other heat sources.</b>
	5	<b>Do not immerse the batteries in water or allow them to get wet.</b>
	6	<b>Do not charge the batteries near a heat source, such as a fire or heater.</b>
	7	<b>Do not pierce the batteries with a sharp object, hit or step on them.</b>
	8	<b>Do not use the batteries mixed with other battery models.</b>
	9	<b>Do not put the batteries into a microwave oven or pressurized container.</b>
	10	<b>If the batteries emit an odor or heat, are deformed or discolored, or in a way appear abnormal during use, charging or storage, immediately remove them and stop using them.</b>

## 21.3 Installing and Removing the Batteries

 <b>WARNING:</b>	<b>Turn off the system and disconnect the adapter from the main unit before installing or removing batteries. Do not install or remove batteries when the system is turned on or the system is turned off but the adapter is connected with the system.</b>
---	---

The batteries are put in the battery bays under the system bottom. You need two batteries. You can install or remove them when the system is turned off and the adapter is disconnected from the main unit.

**To install the batteries:**

- 1 Turn off the system, and disconnect the adapter from the main unit.
- 2 Close the monitor, turn the system upside down and put it on the table.
- 3 You can see two battery bays at the bottom of the system (Note that the batteries shall be put in correct direction; if not, the batteries do not fit). Press the batteries gently until they click. Now the batteries are clocked in the bays.

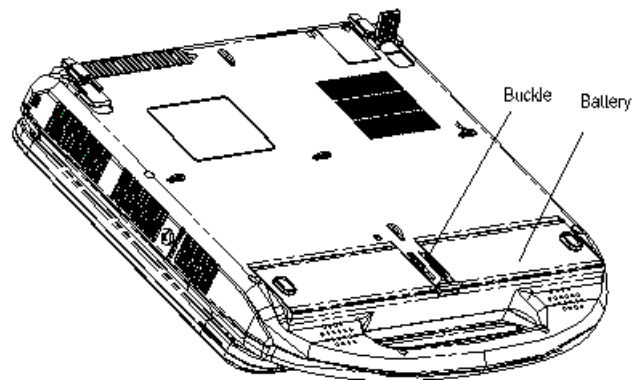
**To remove the batteries:**

- 1 Turn off the system, and disconnect the adapter from the main unit.
- 2 Close the monitor, turn the system upside down and put it on the table.
- 3 Push the buckles located between the two bays to the end to unlock the batteries.
- 4 Take out the batteries from the bays.

## 21.4 Battery Status Indicator

The battery status indicator is located in the lower right corner of the screen, indicating the battery capacity.

- The  icon indicates the battery capacity is empty.

When the power capacity is not enough, the system will pop up a prompt: Warning! Battery is out of power! Please insert the Adapter or system will be shut down in one minute.

Please follow the instruction to maintain the normal operation of the system.

- The  icon indicates the battery capacity is full.
- The battery icons other than the two icons above-mentioned indicate the capacity is between empty and full.

## 21.5 One Full Discharge / Charge Cycle

Upon receipt of the system and before first time usage, it is recommended that you perform one full discharge / charge cycle. If the battery has not been used for over 2 months, you are recommended to perform one full discharge / charge cycle. It is also recommended that the battery is stored in the shady and cool area with FCC (full current capacity).

One Full Discharge / Charge Cycle Process is:

- 1 Full discharge of the battery to let the system automatically shut down.
- 2 Charge the system to 100% FCC (full current capacity).
- 3 Discharge of the system for complete shut down.

## 21.6 Checking Battery Performance

The battery performance may be degraded over time, so you need to check the battery performance periodically. The checking procedures are shown as follows:

- 1 Stop the ultrasound exam.
- 2 Connect the system to the AC power supply to charge the batteries until current capacity is full.
- 3 Disconnect the system from the AC power supply to power the system by the batteries until the system automatically shuts down.
- 4 The powering time of the batteries indicates the battery performance.

If the powering time of the battery is much shorter than that specified in the Specification Manual, you may replace the battery or contact the service personnel.

<b>NOTE:</b> The usage life of the battery is 300 charge / discharge cycles. If the battery is improperly used, its life may be shortened.
--

## 21.7 Battery Disposal

You need to dispose of the battery, when it is,

- Damaged;
- Severely degraded;
- Used for 3 years.

<b>NOTE:</b> You should observe the local regulations when disposing of the battery.
--

# 22 System Maintenance

---

Routine system maintenance shall be completed by the user. Service maintenance will be provided by Mindray service engineers while the system is under warranty. System maintenance after the warranty has expired is the full responsibility of the owner / operator.

- |   |   |  |
|---|---|--|
|  <b>WARNING:</b> | 1 | Only an authorized Mindray service engineer can perform maintenance not specified in this operator's manual. |
|   | 2 | For the sake of the system performance and safety, you should perform periodical checks for the system.      |

## 22.1 Daily Maintenance

You are responsible for daily maintenance.

### 22.1.1 Cleaning the System

- |   |  |
|---|--|
|  <b>WARNING:</b> | Before cleaning the system, be sure to turn off the power and disconnect the power cord from the outlet. If you clean the system while the power is On, it may result in electric shock. |
|---|--|

#### ■ Cleaning a transducer

Please refer to the operator's manual of the corresponding transducer to perform cleaning and disinfection.

#### ■ Cleaning the transducer cable

- a) Use soft dry cloth to wipe off stains from the transducer cable.
- b) If it is difficult to clean the stains thoroughly, use soft cloth dipped with mild detergent, and then let the cable air dry.

#### ■ Cleaning the monitor

Using a soft cloth, apply little clean water or soapy water directly to the cloth and wipe down the monitor to remove finger marks, dust and smudges. Allow the monitor to air-dry.

- |              |   |
|--------------|---|
| <b>NOTE:</b> | Do not use hydrocarbon little clean water or soapy water or cleaner for OA (Office Automation) equipment to clean the monitor. These substances may cause deterioration of the monitor. |
|--------------|---|

- Cleaning the control panel, cover and bracket
  - a) Use dry soft cloth to clean the surface of the system. If the system is dirty, moisten the soft cloth with a mild or neutral detergent and wipe off any stains.
  - b) Use dry soft cloth to remove any moisture and allow all hard surfaces to completely air-dry.

- Cleaning the trackball

1. Disassembling the trackball

Press the bulges on the clamping ring by both hands and turn the ring about 45° clockwise until it lifts. Take out the ring and the rotary ball. Be careful not to drop the ball.

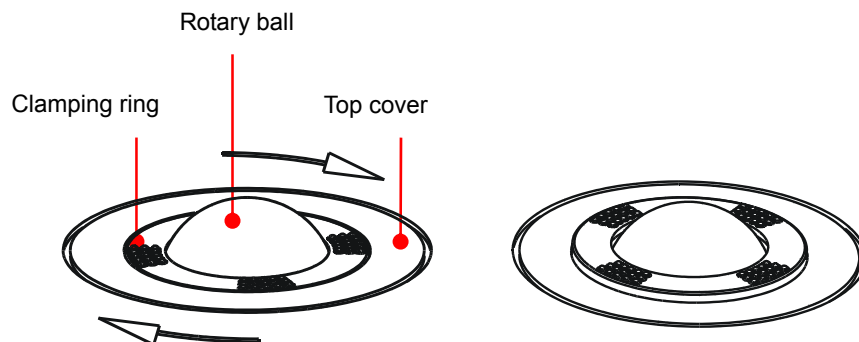

2. Cleaning the trackball mechanism and rotary ball

There can be a considerable buildup of finger oils and dirt on the internal trackball mechanisms. Use a cotton swab or soft dry cloth to clean two long shafts and rotary bearing and to remove any accumulation.

Use the soft dry cloth to clean the rotary ball.

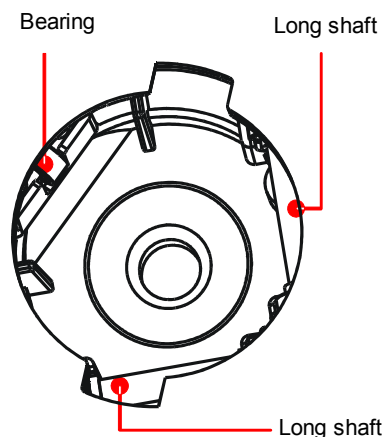

3. Installing the trackball

Put the rotary ball back in the trackball mechanism and align the clamping ring with the top cover notches. Press the bulges on the ring with both hands and turn the ring about 45° counterclockwise until the ring clicks and locks. As the bulges are flush with the top cover, the ring is secured.

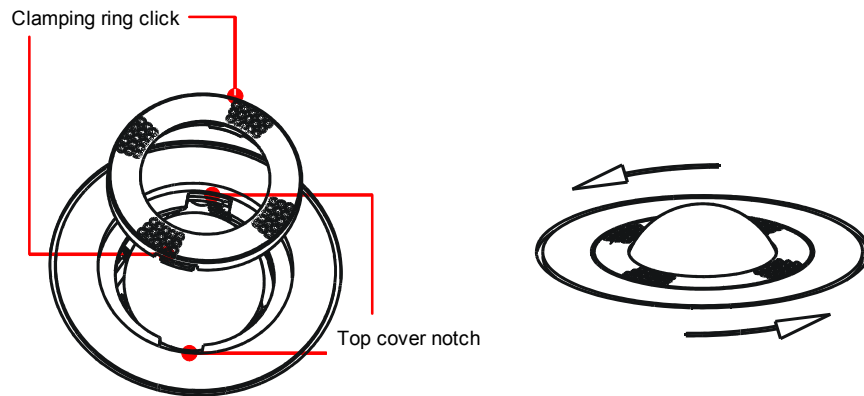

#### ■ Cleaning the Dust Net

There are two dust nets at the system's left side ventilation opening and right side ventilation opening (see the following figures); they are used for preventing dust entry.

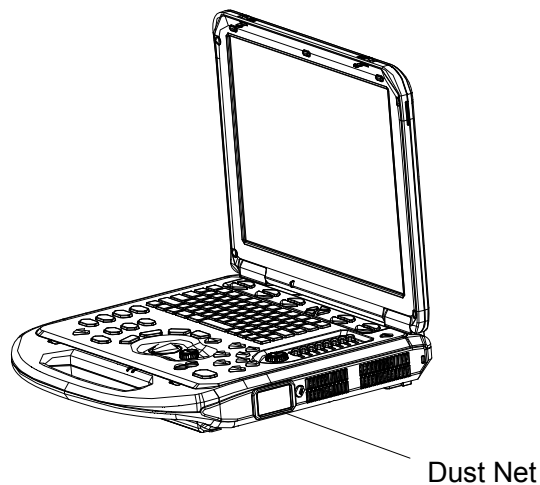
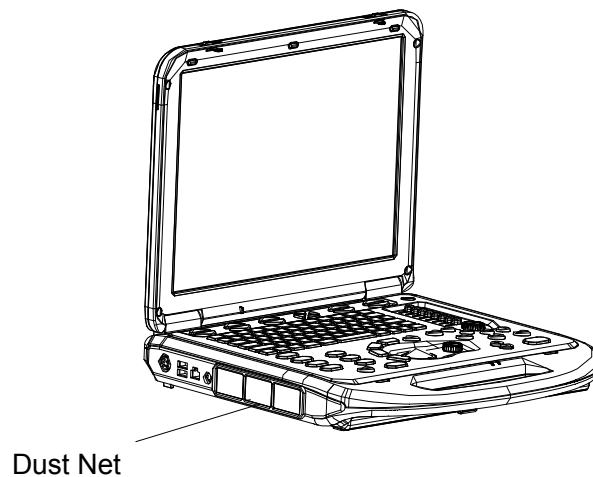

**⚠ CAUTION:** Please clean the dust nets periodically (e.g. once in a month) to keep good ventilation. Otherwise, the system may be damaged. If the system is used in outdoors or a dusty location, please increase the cleaning frequency.



### a) Disassemble the Dust Net

Please disassemble the Dust Net before cleaning it.

Disassemble the Dust Net: hold the outline boarder of the dust net, slightly press the outline boarder (effect on the buckle) in the direction as shown in Step 1; meanwhile, pull out the buckle in the direction as shown in Step 2. After you pull out the other buckle (use the same method as you did on the first buckle), you can take out the dust net.

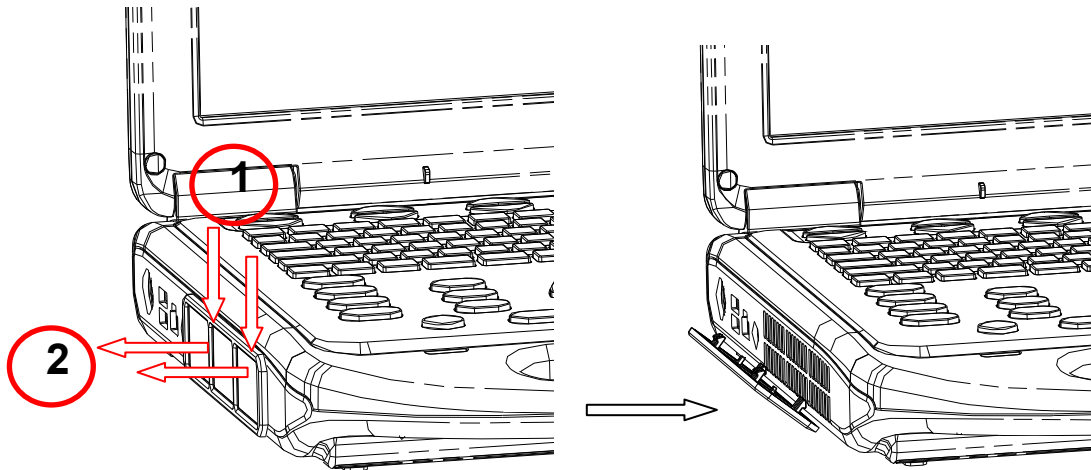

### b) Clean the Dust Net

Use soft dry cloth to clean the dust net; or use rinsing to rinse the dust on it, and then use dry soft cloth to remove any water.

### c) Install the Dust Net:

The installation positions for the two dust nets are totally different, so just align and fix the buckles on the dust net correctly with the corresponding ventilation opening.

## 22.2 Backup of the System Hard Disk

To prevent deterioration or loss of data stored in the system hard disk, create a backup copy of the hard disk at regular intervals.

## 22.3 Maintenance Checks by Service Engineer

The following checks must be performed to ensure and maintain system safety and performance. Please contact Mindray Customer Service Department or sales representative to schedule and carry out these checks.

Check Category	Check Item
Cleaning	Interior of the system Peripherals
Electric safety	Ground leakage current Enclosure leakage current Animal leakage current Animal leakage current (110% supply voltage on applied part) Animal auxiliary leakage current
Mechanical safety	Monitor mounting mechanism Control panel Mounting mechanism for the peripheral devices Other mechanical parts External appearance of the transducer External appearance of ECG lead
Image recording	Images in each mode Image recording by using the standard transducer

## 22.4 Consumables and Periodic Part Replacement

This system contains some consumables and parts requiring periodic replacement. Before replacing them, please contact Mindray Customer Service Department or sales representative for instructions.

## 22.5 Troubleshooting

 <b>CAUTION:</b>	1	<b>Do not spill water or other liquid into the system while you perform the cleaning. Otherwise it may result in malfunction or electric shock.</b>
	2	<b>When you want to clean transducer connectors and TGC sliders, contact Mindray Customer Service Department or sales representative. Cleaning it yourself may result in malfunction or degradation of the performance.</b>

To ensure proper system operation and function, it is recommended that a maintenance and inspection plan be established to periodically check the safety of the system. If any system malfunction is experienced, contact Mindray Customer Service Department or sales representative.

If any persistent system malfunction is experienced, e.g. an onscreen error message, blank imaging screen, absent menus, please refer to the following table below. If the failure cannot be eliminated, please contact Mindray Customer Service Department or sales representative.

Troubleshooting Table

No	Failure	Cause	Measure
1	After the power supply is turned on, the power indicator does not light on.	Abnormal power system or incorrect connection of the power cord.	<ol style="list-style-type: none"> <li>1. Verify the system is plugged in.</li> <li>2. Verify that the plug has not become loosened or dislodged from the back of the system.</li> </ol>
2	When the power indicator of the monitor is on and image is blank.	<ol style="list-style-type: none"> <li>1. The interval between turnoff and restart is too short – wait minimum 20 seconds.</li> <li>2. The monitor brightness or contrast may be improperly set.</li> </ol>	<ol style="list-style-type: none"> <li>1. Turn off the system and wait minimum 1 minute, then restart the system.</li> <li>2. Adjust the monitor brightness and contrast back to factory defaults.</li> </ol>
3	The monitor displays the characters but no images.	<ol style="list-style-type: none"> <li>1. The transmission power, overall gain or TGC controls are improperly set.</li> <li>2. Verify that a transducer is connected and / or fully connected.</li> <li>3. The system is in the frozen status.</li> </ol>	<ol style="list-style-type: none"> <li>1. Adjust the transmission power, gain or TGC control.</li> <li>2. Ensure proper transducer connection.</li> <li>3. Unfreeze the image.</li> </ol>
4	The image quality has degraded	<ol style="list-style-type: none"> <li>1. The exam type is not correct.</li> <li>2. The settings of the image post processing are not correct.</li> <li>3. The image presets are appropriate</li> </ol>	<ol style="list-style-type: none"> <li>1. Select an appropriate exam type.</li> <li>2. Adjust the settings of the image via post processing or reset the post processing to the default values.</li> <li>3. Reset the factory default setups.</li> </ol>

# 23 Acoustic Output

---

This section of the operator's manual applies to the overall system including the main unit, transducers, accessories and peripherals. This section contains important safety information for operators of the device, pertaining to acoustic output and how to control patient exposure through use of the ALARA (as low as reasonably achievable) principle. Also this section contains information regarding the acoustic output testing and the real-time output display.

Read this information carefully before using the system.

## 23.1 Concerns with Bioeffects

Diagnostic ultrasound is recognized as being safe. In fact, there have been no reports of injuries to patients caused by diagnostic ultrasound.

It cannot be stated categorically that ultrasound is 100% safe. Studies have revealed that ultrasound with extremely high intensity is harmful to body tissues.

Diagnostic ultrasound technology has made a great leap forward during the last several years. This rapid advance has generated concerns about the potential risk of bioeffects when new applications or diagnostic technologies become available.

## 23.2 Prudent Use Statement

Although there are no confirmed biological effects on patients caused by exposures from present diagnostic ultrasound instruments, the possibility exists that such biological effects may be identified in the future. Thus ultrasound should be used in a prudent manner to provide medical benefit to the patient. High exposure levels and long exposure times should be avoided while acquiring necessary clinical information.

## 23.3 ALARA Principle (As Low As Reasonably Achievable)

It is required to practice ALARA when using ultrasound energy. Practicing ALARA ensures that the total energy level is controlled below a low enough level at which bioeffects are not generated while diagnostic information is being accumulated. The total energy is controlled by output intensity and total radiation time. The output intensity necessary for examinations differs depending on the patient and the clinical case.

Not all examinations can be performed with an extremely low level of acoustic energy. Controlling the acoustic level at an extremely low level leads to low-quality images or insufficient Doppler signals, adversely affecting the reliability of the diagnosis. However, increasing the acoustic power more than necessary does not always contribute to an increase in quality of information required for diagnosis, rather increasing the risk of generating bioeffects.

Users must take responsibility for the safety of patients and utilize ultrasound deliberately. Deliberate use of ultrasound means that output power of ultrasound must be selected based on ALARA.

Additional information regarding the concept of ALARA and the possible bioeffects of Ultrasound is available in a document from the AIUM (American Institute of Ultrasound Medicine) title "*Medical Ultrasound Safety*".

## 23.4 MI/TI Explanation

### 23.4.1 Basic Knowledge of MI and TI

The relationship of various ultrasound output parameters (frequency, acoustic pressure and intensity, etc) to bioeffects is not fully understood presently. It is recognized that two fundamental mechanisms may induce bioeffects. One is a thermal bioeffect with tissue absorption of ultrasound, and another one is a mechanical bioeffect based on cavitations. Thermal Index (TI) gives the relative index of temperature increase by thermal bioeffect, and Mechanical Index (MI) gives the relative index of mechanical bioeffect. TI and MI indices reflect instantaneous output conditions, so they do not consider the cumulative effects of the total examination time. TI and MI models contain practical simplifications to complex bioeffects interaction. Then the operator should be aware that the actual worst case temperature rise may be up to several times higher than the displayed TI value.

#### MI (Mechanical Index):

The mechanical bioeffects are the result of compression and decompression of insonated tissues with the formation of micro bubbles that may be referred to as cavitations.

MI is an index that shows the possibility of the cavitations generation based on acoustic pressure, and the value in which the peak-rarefactional acoustic pressure is divided by the square root of the frequency. Therefore MI value becomes smaller when the frequency is higher or the peak-rarefactional acoustic pressure is lower, it becomes difficult to generate the cavitations.

$$MI = \frac{P_{r, \alpha}}{\sqrt{f_{awf}} \times C_{MI}},$$

$$C_{MI} = 1 \text{ (MPa} / \sqrt{\text{MHz}} \text{)}$$

For the frequency 1 MHz and the peak-rarefactional acoustic pressure 1 MPa, MI becomes 1. It is possible to think MI to be one threshold of the cavitations generation. Especially, it is important to keep MI value to be low when both gases and the soft tissues exist together, for such as lung exposure in cardiac scanning and bowel gas in abdominal scanning.

#### TI (Thermal Index):

TI is determined by the ratio of the total acoustic power to the acoustic power required to raise the tissue temperature by 1 degree C. In addition, because the temperature rises is greatly different according to tissue structures, TI is divided three kinds: TIS (Soft-tissue Thermal Index), TIB (Bone Thermal Index) and TIC (Cranial-bone Thermal Index).

- TIS: Thermal index related to soft tissues, such as abdominal and cardiac applications.
- TIB: Thermal index for applications, such as fetal (second and third trimester) or neonatal cephalic (through the fontanel), in which the ultrasound beam passes through soft tissue and a focal region is in the immediate vicinity of bone.

- TIC: Thermal index for applications, such as pediatric and adult cranial applications, in which the ultrasound beam passes through bone near the beam entrance into the body.

Although the output power is automatically controlled for the selected applications, high TI values should be kept to a minimum or avoided in obstetric applications. WFUMB (World Federation for Ultrasound in Medicine and Biology) guidelines: state that temperature increase of 4 degree C for 5 min or more should be considered as potentially hazardous to embryonic and fetal tissue.

### 23.4.2 MI/TI Display

TI and MI values are displayed in the upper part of the screen in real-time. The operator should monitor these index values during examinations and ensure that exposure time and output values are maintained at the minimum amounts needed for effective diagnosis.

<b>NOTE:</b>	If there is a value of MI or TI exceeds 1.0, you must be careful to practice the ALARA principle.
--------------	---

The display precision is 0.1.

## 23.5 Acoustic Power Setting

- Acoustic power adjustment

Use the soft menu control to click [A. Power] in the menu to adjust the acoustic power percentage, and its value is displayed on the soft menu item as well as at the top of the screen. The greater the acoustic power percentage, the greater the current acoustic output. When the image is frozen, the system stops transmitting acoustic power.

- Default setting of acoustic power

Selection of diagnostic applications is the most important factor for controlling ultrasound output. The permissible level of intensity of ultrasound differs depending on the region of interest. For fetal examinations, in particular, much care must be exercised.

In this system, imaging setups can be created using the ultrasound output set by you. **At this time, the default function is disabled. It is the user's responsibility for any change to the default settings.**

#### Default choices

Initial power	7% to 100%*
---------------	-------------

\* Definition of 100%: The maximum acoustic power of a transducer determined by the increase in transducer surface temperature in the selected mode and the acoustic power restrictions specified by the FDA.

<b>NOTE:</b>	This system automatically returns to the settings whenever changes are made to the values (when you turn on the power, switch between transducers, press [End Exam], or select [Return] in the Setup menu). In the factory default settings, the Acoustic Output is limited below 100%. Following the ALARA restriction, you are allowed to increase the acoustic power under FDA 510(k) Guidance-Track3 limits and to set it in the image preset screen.
--------------	---

The acoustic output of the system has been measured and calculated in accordance with IEC60601-2-37: 2005, FDA 510(K) GUIDANCE, Acoustic Output Measurement Standard for Diagnostic Ultrasound Equipment (NEMA UD-2 2004) and the Standard for Real-Time Display of Thermal and Mechanical Acoustic Output Indices on Diagnostic Ultrasound Equipment (AIUM and NEMA UD-3 2004).

## 23.6 Acoustic Power Control

The qualified operator may use the system controls to limit the ultrasound output and to adjust the quality of the images. There are three categories of system controls relative to output. They are,

1. Controls that have direct effect on the output,
2. Controls that indirectly control output and
3. Controls that are receiver controls

- **Direct Controls**

It is possible to control, if necessary, the acoustic output with the soft menu control on the control panel. In this case, the maximum value of the acoustic output never exceeds an MI of 1.9, TI of 6 and an  $I_{SPTA,3}$  of  $720 \text{ mW/cm}^2$  in any mode of operation.

- **Indirect Controls**

The controls that indirectly affect output are many imaging parameters. These are operating modes, frequency, focal point positions, image depth and pulse repetition frequency (PRF).

The operating mode determines whether the ultrasound beam is scanning or non-scanning. Thermal bioeffect is closely connected to M Mode, Doppler and Color Mode. Acoustic attenuation of tissue is directly related to transducer frequency. The focal point is related to active aperture of transducer and beam width. For the higher PRF (pulse repetition frequency), the more output pulses occur over a period of time.

- **Receiver Controls**

The receiver controls (for example, gain, dynamic range, and image post-processing, etc.) do not affect output. These controls should be used, when possible, to improve the image quality before using controls that directly or indirectly affect output.

## 23.7 Acoustic Output

### 23.7.1 Derated Ultrasonic Output Parameters

In order to determine the relevant Ultrasonic Output Parameters, a method is used which allows for the comparison of ultrasound systems which operate at different frequencies and are focused at different depths. This approach, called "derating" or "attenuating", adjusts the acoustic output as measured in a water tank to account for the effect of ultrasound propagation through tissue. By convention, a specific average intensity attenuation value is used, which corresponds to a loss of 0.3 dB/cm/MHz. That is, the intensity of ultrasound will be reduced by 0.3 dB/MHz for every centimeter of travel from the transducer. This can be expressed by the following equation:

$$I_{atten} = I_{water} \times 10^{(-0.3/10 \times f_c \times z)}$$

Where  $I_{\text{atten}}$  is the attenuated intensity,  $I_{\text{water}}$  is the intensity measured in a water tank (at distance  $z$ ),  $f_c$  is the center frequency of the ultrasound wave (as measured in water), and  $z$  is the distance from the transducer. The equation for attenuating pressure values is similar except that the attenuation coefficient is 0.15 dB/cm/MHz, or one-half the intensity coefficient. The intensity coefficient is double the pressure coefficient because intensity is proportional to the square of pressure.

Although the attenuation coefficient chosen, 0.3 dB/cm/MHz, is significantly lower than any specific solid tissue in the body, this value was chosen to account for fetal examinations. In early trimester ultrasound fetal examinations, there may be a significant fluid path between the transducer and the fetus, and the attenuation of fluid is very small. Therefore the attenuation coefficient was lowered to account for this case.

## 23.7.2 Limits of Acoustic Output

In accordance with the FDA Track 3 requirements, the derating (or attenuated) approach was incorporated into the FDA Acoustic Output Limits, as listed below. The maximum acoustic output level from any transducer in any operating mode is expected to fall below these limits.

**FDA Maximum Acoustic Output Limits for Track 3 (Attenuated Values)**

Application	$I_{\text{spta}.3}$ (mW/cm <sup>2</sup> )	$I_{\text{sppa}.3}$ (W/cm <sup>2</sup> )	MI
Regions (except eyes)	720	≤ 190	or ≤ 1.9

## 23.7.3 Differences between Actual and Displayed MI and TI

In operation, the system will display to the operator the Acoustic Output Parameters Thermal Index, TI, or Mechanical Index, MI (or sometimes both parameters simultaneously). These parameters were developed as general indicators of risk from either thermal or mechanical action of the ultrasound wave. They serve to indicate to the operator whether a particular setting of the system increases or decreases the possibility of Thermal or Mechanical effect. More specifically, they were designed to assist in the implementation of the ALARA principle. As an operator changes a given system control, the potential effect of the change in output will be indicated. However, the Thermal Index is not the same as temperature rise in the body, for several reasons. First of all, in order to provide a single display index to you, a number of simplifying assumptions had to be made. The biggest assumption was the use of the attenuating formula described above, which is much lower than the actual value for most tissues within the body. Scanning through muscle or organ tissue, for example, will produce much higher attenuation than 0.3 dB/cm/MHz. There were also significant simplifications made for the thermal properties of tissue. Therefore, scanning through highly perfused tissue, such as the heart or vasculature, will produce significantly less thermal effect than that suggested by the Thermal Index.

Similarly, the Mechanical Index was derived to indicate the relative possibility of mechanical (cavitation) effects. The MI is based on the derated peak-rarefactional pressure and the center frequency of the ultrasound wave. The actual peak-rarefactional pressure is affected by the actual attenuation caused by tissue in the path between the transducer and the focal point. Again, all solid tissues within the body have higher attenuation than the proscribed 0.3 dB/cm/MHz value, and therefore, the actual



peak-rarefactional pressure will be lower. Further, the actual peak-rarefactional pressure will change depending upon the region of the body being scanned.

For these reasons, the TI and MI displays should only be used to assist the operator in implementing ALARA at the time of the patient examination.

## 23.8 Measurement Uncertainty

Power	32.9 % (non-scanning mode)
	5.1% (Scanning mode)
Frequency	2%
Peak-rarefactional pressure	16.4 %
MI	16.4 %

## 23.9 References for Acoustic Power and Safety

1. "Bioeffects and Safety of Diagnostic Ultrasound" issued by AIUM in 1993
2. "Medical Ultrasound Safety" issued by AIUM in 1994
3. "Acoustic Output Measurement Standard for Diagnostic Ultrasound Equipment, Revision 3" issued by AIUM/NEMA in 2004
4. "Standard for real-time display of thermal and mechanical acoustic output indices on diagnostic ultrasound equipment, Revision 2" issued by AIUM/NEMA in 2004
5. "Information for Manufacturers Seeking Marketing Clearance of Diagnostic Ultrasound Systems and Transducers" issued by FDA in 1997.
6. "Medical electrical equipment – Part 2-37: Particular requirements for the safety of ultrasonic medical diagnostic and monitoring equipment" issued by IEC in 2005 (Amendment 2).

# 24 Measurement Accuracy

**Table 1 Error of Two-Dimensional Images**

Parameter	Value range	error
Depth / Distance	Maximum 300 mm	Within + / - 3%; or when the measured value is less than 40 mm, the error is less than 1.5 mm.
Area (Trace)	Maximum 1126 cm <sup>2</sup>	Within + / - 7%; or when the measured value is less than 16 cm <sup>2</sup> , the error is less than 1.2 cm <sup>2</sup>
Area (ellipse, circle)	Maximum 884cm <sup>2</sup>	Within + / - 7%; or when the measured value is less than 16 cm <sup>2</sup> , the error is less than 1.2 cm <sup>2</sup>
Angle	0~180°	Within + / - 3%
% Stenosis	Maximum 1.0	Within + / - 7%
Volume	Maximum 999cm <sup>3</sup>	Within + / - 10 %; or when the measured value is less than 64 cm <sup>3</sup> , the error is less than 6.4 cm <sup>3</sup>

**Table 2 Time / Motion Measurements**

Parameter	Value range	Error
Distance	Maximum 300mm	Within + / - 3 %; or when the measured value is less than 40mm, the error is less than 1.5mm
Time	Maximum 8s	Within + / - 1%
Heart rate	15~999 beats per minute	Within + / - 4%
Slope (M mode)	Maximum 999mm / s	Within + / - 4%

**Table 3 Doppler Speed Measurement**

Parameter	Range	error
Speed	20~250cm/s	Within + / - 5%

**Table 4 iScape Measurement**

Parameter	Value Range	Error
Distance	/	Within + / - 5%

**NOTE:** Within the selected field range, the measurement accuracy is ensured within the range mentioned above. The accuracy specifications are performance in the worst conditions, or based on the real test for the system, regardless of acoustic speed error.

# 25 Safety Classification

---

1. According to the type of protection against electric shock:
  - a) CLASS I EQUIPMENT
2. According to the degree of protection against electric shock:
  - a) TYPE-BF EQUIPMENT
3. According to the degree of protection against harmful ingress of water:
  - a) The main unit belongs to IPX0, and the transducers belong to IPX7.
  - b) Footswitch: 971-SWNOM belongs to IP68.
4. According to the degree of safety of application in the presence of a FLAMMABLE ANESTHETIC MIXTURE WITH AIR or WITH OXYGEN OR NITROUS OXIDE:
  - a) EQUIPMENT not suitable for use in the presence of a FLAMMABLE ANESTHETIC MIXTURE WITH AIR or WITH OXYGEN OR NITROUS OXIDE
5. According to the mode of operation:
  - a) CONTINUOUS OPERATION
6. According to the installation and use:
  - a) PORTABLE EQUIPMENT
  - b) MOBILE EQUIPMENT (when the system is installed on the mobile trolley)

# 26 Guidance and Manufacturer's Declaration

---

The system complies with the EMC standard IEC60601-1-2: 2001+A1:2004.

 **WARNING:** The use of unapproved accessories may diminish system performance.

- NOTE:**
- 1 Use of accessories, transducers, and cables other than those specified may result in increased emission or decreased immunity of system.
  - 2 The system should not be used adjacent to or stacked with other equipment. If adjacent or stacked use is necessary, system should be observed to verify normal operation in the configuration in which it will be used.
  - 3 The system needs special precautions regarding EMC and needs to be installed and put into service according to the EMC information provided below.
  - 4 Preventing conducted RF immunity. Due to technological limitations, the conducted RF immunity level are limited to 1Vrms level, conducted RF interference above 1Vrms may cause wrong diagnosis and measurements. We suggest that you position system further from sources of conducted RF noise.
  - 5 Operation of system, in the case that the patient physiological signal is lower than the minimum amplitude or value specified in the product specifications, may cause inaccurate results.
  - 6 Portable and mobile RF communications equipment can affects system. See tables 1, 2, 3, and 4 below.

TABLE 1

<b>GUIDANCE AND MINDRAY DECLARATION—ELECTROMAGNETIC EMISSIONS</b>		
The system is intended for use in the electromagnetic environment specified below. The customer or the user of system should assure that it is used in such an environment.		
<b>EMISSIONS TEST</b>	<b>COMPLIANCE</b>	<b>ELECTROMAGNETIC ENVIROMENT—GUIDANCE</b>
RF emissions CISPR 11	Group1	The system uses RF energy only for its internal function. Therefore, its RF emissions are very low and are not likely to cause any interference in nearby electronic equipment.  The system is suitable for use in all establishments including domestic establishments and those directly connected to the public low-voltage power supply network that supplies buildings used for domestic purposes
RF emissions CISPR 11	Class B	
Harmonic Emissions IEC61000-3-2	Class A	
Voltage Fluctuations / Flicker Emissions IEC61000-3-3	Compliance	

TABLE 2

**GUIDANCE AND MINDRAY DECLARATION—ELECTROMAGNETIC IMMUNITY**

The system is intended for use in the electromagnetic environment specified below. The customer or the user of system should assure that it is used in such an environment.

<b>IMMUNITY TEST</b>	<b>IEC 60601 TEST LEVEL</b>	<b>COMPLIANCE LEVEL</b>	<b>ELECTROMAGNETIC ENVIRONMENT-GUIDANCE</b>
Electrostatic Discharge(ESD) IEC 61000-4-2	±6 kV contact ±8 kV air	±6 kV contact ±8 kV air	Floors should be wood, concrete or ceramic tile. If floors are covered with synthetic material, the relative humidity should be at least 30%.
Electrical fast Transient / burst IEC 61000-4-4	±2 kV for power supply voltage ±1 kV for input / output voltage	±2 kV for power supply voltage ±1 kV for input / output voltage	The power supply quality should be that of a typical commercial or hospital environment.
Surge IEC 61000-4-5	±1 kV voltage (s) to voltage (s) ±2 kV voltage (s) to earth	±1 kV voltage (s) to voltage (s) ±2 kV voltage (s) to earth	The power supply quality should be that of a typical commercial or hospital environment.
Voltage dips, Short interruptions and voltage variation on power supply input voltage IEC 61000-4-11	<5% $U_T$ (>95% dip in $U_T$ ) for 0.5 cycle  40% $U_T$ (60% dip in $U_T$ ) for 5 cycle  70% $U_T$ (30% dip in $U_T$ ) for 25 cycle  <5% $U_T$ (>95% dip in $U_T$ ) for 5 sec	<5% $U_T$ (>95% dip in $U_T$ ) for 0.5 cycle  40% $U_T$ (60% dip in $U_T$ ) for 5 cycle  70% $U_T$ (30% dip in $U_T$ ) for 25 cycle  <5% $U_T$ (>95% dip in $U_T$ ) for 5 sec	The power supply quality should be that of a typical commercial or hospital environment. If you require continued operation during power supply interruptions, it is recommended that our product be powered from an uninterruptible power supply or a battery.
Power frequency (50/60 HZ) magnetic field IEC 61000-4-8	3 A/m	3 A/m	Power frequency magnetic fields should be at levels characteristic of a typical location in a typical commercial or hospital environment.

NOTE:  $U_T$  is the A.C. power voltage prior to application of the test level.

**TABLE 3**

**GUIDANCE AND MINDRAY DECLARATION—ELECTROMAGNETIC IMMUNITY**

The system is intended for use in the electromagnetic environment specified below. The customer or the user of system should assure that it is used in such an environment.

IMMUNITY TEST	IEC 60601-1-2 TEST LEVEL	COMPLIANCE LEVEL	ELECTROMAGNETIC ENVIRONMENT-GUIDANCE
Conducted RF IEC 1000-4-6	3 Vrms 150kHz to 80MHz	1 Vrms	Portable and mobile RF communications equipment should be used no closer to any part of system, including cables, than the recommended separation distance calculated from the equation applicable to the frequency of the transmitter. Recommended separation distance $d = 3.5 \times \sqrt{P}$ $d = 1.2 \times \sqrt{P}$ 80 MHz to 800 MHz $d = 2.3 \times \sqrt{P}$ 800 MHz to 2.5GHz where P is the maximum output power rating of the transmitter in watts (W) according to the transmitter manufacturer and d is the recommended separation distance in meters (m).
Radiated RF IEC 1000-4-3	3 V/m 80MHz to 2.5 GHz	3V/m	Field strengths from fixed RF transmitters, as determined by an electromagnetic site survey, should be less than the compliance level in each frequency range. Interference may occur in the vicinity of equipment marked with the following symbol: 

Note 1 At 80 MHz and 800 MHz, the higher frequency range applies.

Note 2 These guidelines may not apply in all situations. Electromagnetic propagation is affected by absorption and reflection from structures, objects and people.

- Field strengths from fixed transmitters, such as base stations for radio (cellular / cordless) telephones and land mobile radios, amateur radio, AM and FM radio broadcast and TV broadcast cannot be predicted theoretically with accuracy. To assess the electromagnetic environment due to fixed RF transmitters, an electromagnetic site survey should be considered. If the measured field strength in the location in which system is used exceeds the applicable RF compliance level above, system should be observed to verify normal operation. If abnormal performance is observed, additional measures may be necessary, such as reorienting or relocating system.
- Over the frequency ranges 150kHz to 80MHz, field strengths should be less than 1V/m.

**TABLE 4**

**RECOMMENDED SEPARATION DISTANCES BETWEEN PORTABLE AND MOBILE RF COMMUNICATION DEVICE AND SYSTEM**

The system is intended for use in an electromagnetic environment in which radiated RF disturbance are controlled. The customer or the user of system can help prevent electromagnetic interference by maintaining a minimum distance between portable and mobile RF communication equipment (transmitters) and system as recommended below, according to the maximum output power of the communication equipment.

Rated Maximum Output power of Transmitter <b>W</b>	Separation Distance According to Frequency of Transmitter <b>m</b>		
	150kHz -80MHz $d = \left[ \frac{3.5}{1} \right] \sqrt{P}$	80MHz -800MHz $d = \left[ \frac{3.5}{3} \right] \sqrt{P}$	800MHz -2.5GHz $d = \left[ \frac{7}{3} \right] \sqrt{P}$
0.01	0.35	0.12	0.23
0.1	1.11	0.37	0.74
1	3.50	1.17	2.34
10	11.07	3.69	7.38
100	35.00	11.67	23.34

For transmitters at a maximum output power not listed above, the recommended separation distanced in meters (m) can be determined using the equation applicable to the frequency of the transmitter, where P is the maximum output power rating of the transmitter in watts (W) according to the transmitter manufacturer.

If system image distortion occurs, it may be necessary to position system further from sources of conducted RF noise or to install external power source filter to minimize RF noise to an acceptable level.

Note 1 At 80 MHz and 800 MHz, the separation distance for the higher frequency range applies.

Note 2 These guidelines may not apply in all situations. Electromagnetic propagation is affected by absorption and reflection from structures, objects and people.



# Appendix A Wireless LAN

<p><b>⚠ WARNING</b></p> <ol style="list-style-type: none"><li>1. It is prohibited to use the wireless LAN function in airplane, as it may violate the relevant provisions in the aviation regulations.</li><li>2. Use the wireless LAN function prudently in the emergency ambulance (or other vehicles) as other devices or communication signals may be interfered.</li><li>3. Be prudent to use the wireless LAN function in OR/ ICU/ CCU as it may interfere other devices.</li><li>4. When wireless LAN function is turned on, the ultrasound system may be interfered with by other equipment, even if that other equipment complies with CISPR EMISSION requirements.</li></ol>
--

## A.1 To Use the W-LAN Function

<p><b>NOTE</b> DO Not edit IP address in Network Preset page as the network task is executed, otherwise it fails. View if there is any undergoing task in task manager of the system.</p>
---



The system can be configured with wireless net adapter, so as to assist information query and unlimited network service.

1. Connect the wireless LAN adapter using the USB port.
2. Local TCP/IP setting in preset:
  - a) Press <Setup> to enter the Setup menu.
  - b) Move the cursor onto [Network Preset], select [Local TCP/IP] to open the screen, as shown in the figure below:

c) Local TCP/ IP preset items are described as follows:

Name	Description
Station Name	Name of the ultrasound system.
Station Location	Location or department where the system is placed.
Current Network Adapter	To select net adapter type.
DHCP / Static	If "DHCP" is selected, IP address will be automatically obtained from DNS server; if "Static" is selected (using static IP address), you need to enter the IP address.
IP Address	IP address of the system.
Subnet Mask	Used to set different network segment.
Gateway	Used to set the gateway IP.
OK	Click to confirm parameter setting.
Cancel	Click to cancel parameter preset.

The IP address of the system should not be occupied by other devices in the LAN, or failure may result.

3. Click the wireless LAN manager icon  in the lower right corner of the toolbar region, and the manager dialogue box pops up:
- [Connect]: select the target network and click to connect, and the manager icon turns  after connected.
  - [Disconnect]: select the target network and click to disconnect.
  - [Refresh]: click to update the wireless network list.
  - [Configure]: click to enter the “Local TCP/IP” setting screen.
  - [Show Detail]: click to view the connection information of the wireless network, and select [Export] in the prompted dialogue box to save the information.
  - [Set Preferred Network]: click to set the selected network to be a default connecting network, and the system will automatically connect to this network after detecting it.
  - [Delete Profile]: click to delete the preferred network setting and password that has been entered.

**NOTE:**

1. When connecting an encrypted network, entered password will be remembered by the system.
2. When there is more than one wireless router in the LAN, DO NOT disable the DHCP function of the current router.
3. If error password has been entered when connecting an encrypted network, click [Delete Profile] and reconnect the network.

Tips: if abnormal network performance is detected, e.g. wireless network list is not updated in time; you may take the following measures:

1. Connect/disconnect the network adapter again.
2. Restart the router and ultrasound system if the problem is not fixed.
3. Restart the router again and wait for 5-10 min and reconnect the network again if the problem is not fixed.

## A.2 To Install Drive for Wireless Adapter

You can install drive for wireless adapters through the following path (take DWA-125 D-LINK as an example):

- a) Acquire the License file from the service engineer.
- b) Press <Setup> to enter the Setup menu.
- c) Move the cursor onto [Network Preset], select [Setup Wireless Driver] to open the screen, as shown in the figure below:
- d) Select the path for installing the drive and click [OK] to pop up the driver install dialogue box.
- e) The wireless LAN manager icon will display in the lower right corner of the toolbar region after the installation succeeds.

Please contact service engineer if you have any questions.

# Appendix B DICOM

The DICOM package is optional, so the description here is only applicable for the system configured with the DICOM package.

**NOTE:** Before using DICOM, please read the electronic file DICOM CONFORMANCE STATEMENT along with the device.

The system supports the following optional DICOM functions:

- Verify Connectivity
- Storage
- Print
- Storage Commitment
- MPPS (Modality Performed Procedure Step)
- DICOM Worklist
- DICOM Query/ Retrieve
- DICOM Task Management
- DICOM Media Storage

Workflows of DICOM preset and application are briefly described as follows:

1. DICOM preset (Local TCP/IP setting, DICOM local setting, DICOM server setting, and DICOM service setting)
2. Verify Connectivity.
3. DICOM Services (image storage, image print, MPPS, Worklist, storage commitment, media storage, Query/Retrieve).

## B.1 DICOM Preset

### B.1.1 Local TCP/IP Setting

**NOTE** DO Not edit IP address in Network Preset page as the network task is executed, otherwise it fails. View if there is any undergoing task in task manager of the system.

To set the network properties of the ultrasound system.

To enter Local TCP/IP setting screen:

1. Press <Setup> to enter the Setup menu.
2. Move the cursor onto [Network Preset], the submenu pops up.
3. Select Local TCP/IP, as shown in the figure:

Local TCP/IP setting items are described as follows:

- 1 Station Name: Name of the ultrasound system
- 2 Station Location: Location or department where the system is placed.
- 3 Current Net Adapter: to select the network connection mode
- 4 DHCP/ Static: If “DHCP” is selected, IP address will be automatically obtained from DNS server; if “Static” is selected (using static IP address), you need to enter the IP address.
- 5 IP Address: IP address of the system; should be at the same network segment with the service IP address.
- 6 Subnet Mask: Used to set different network segment.
- 7 Gateway: Used to set the gateway IP.
- 8 OK: Click to confirm parameter setting.
- 9 Cancel: Click to cancel parameter setting.

Tips:

- The IP address of the system should not be occupied by other devices in the LAN, or failure occurs.
- After you changed “Station Name”, you need to restart the system to make the setting effective (press the power button and select “Shut Down” and restart the system after a while).

## B.1.2 DICOM Local Setting

To set the DICOM server properties and log saving manner.

To enter the screen:

1. Press <Setup> to enter the Setup menu.
2. Move the cursor onto [Network Preset], the submenu pops up.
3. Select [DICOM Local], as shown in the following figure:

The screenshot shows a dark-themed interface for configuring DICOM local settings. The title bar reads 'DICOM Local'. The main content is divided into two rounded rectangular sections. The first section, titled 'Localhost DICOM Service Property(Including SCU and SCP)', contains three input fields: 'AE Title' (empty), 'Port' (2345), and 'PDU' (32768). The second section, titled 'Log Setting', contains two fields: 'File Name' (DcmLog20100323.txt) and 'Log Level' (Service result log). At the bottom of the screen, there are 'OK' and 'Cancel' buttons, and a system tray in the bottom right corner showing the time 18:54.

DICOM local setting items are described as follows:

- 1 AE Title: Application entity title of the ultrasound system, which should be consistent with one of the acceptable SCU set in the server.
- 2 Port: DICOM communication port, which should be the same with the one in the server.
- 3 PDU: Maximum PDU data package size ranging from 16384 to 65536. If the value is less than 16384 or greater than 65536, the system automatically sets it to the value 32768.
- 4 File Name: name of the DICOM log, generated by the system automatically.
- 5 Log Level: to set the log type.  
The available selections: No log, Service result log, Service process log, All log.  
We suggest setting "All log", so that you can see the DICOM log.
- 6 OK: Click to confirm parameter setting.
- 7 Cancel: Click to cancel parameter setting.

Enter AE Title, Port, and PDU according to the actual situation, and then click [OK] to exit the screen.

Tips:

- AE Title should be the same with the SCU AE Title preset in the server (PACS/ RIS/ HIS), for example, if the AE Title of the server preset in the print server is AAA, and the AE Title of the accepted SCU is preset as MMM, then in the figure above, the AE Title of Local should be MMM, and the AE Title of print server should be AAA.

### B.1.3 DICOM Server Setting

The Server Setting function is used to add or delete DICOM servers, or set IP address for the DICOM server.

To enter the screen:

1. Press <Setup> to enter the Setup menu.
2. Move the cursor onto [Network Preset], the submenu pops up.
3. Select [DICOM Server], as shown in the following figure:

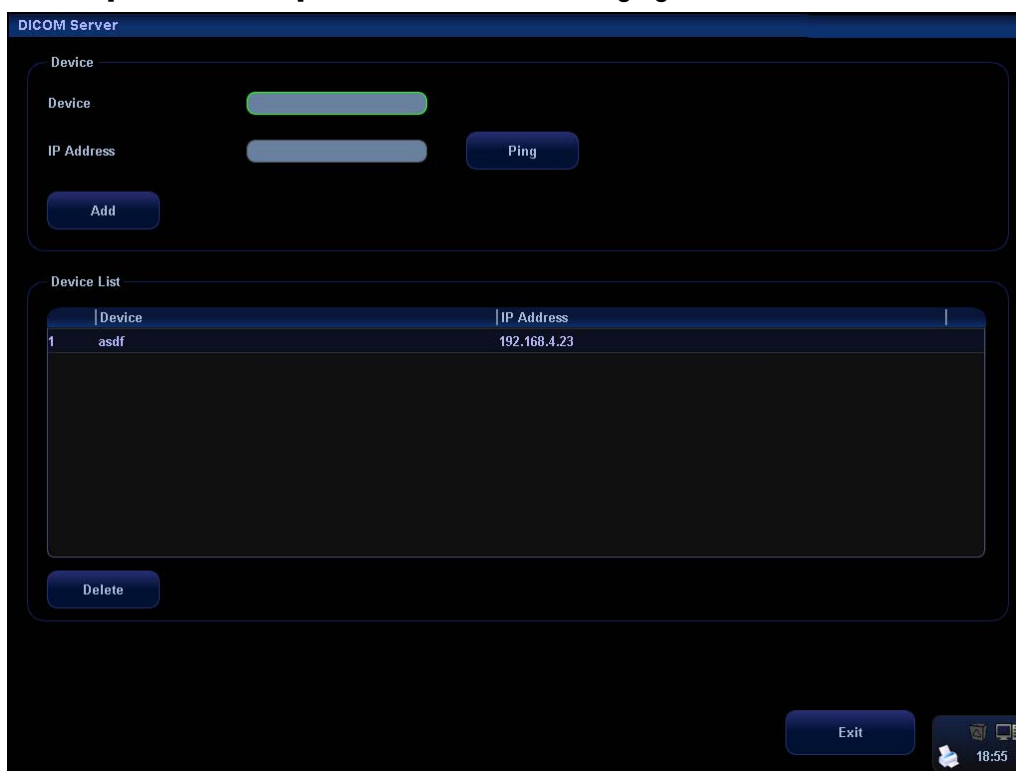

DICOM server setting items are described as follows:

- 1 Device: Name of the device supporting DICOM services.
- 2 IP Address: IP address of the server.  
Ping: You can ping other machines to verify connection after entering the correct IP address. Also you can check the connection of the already added server in the list.
- 3 Add: Click to add servers to the device list.
- 4 Delete: Click to delete the selected server (s) in the device list.
- 5 Exit: Click to exit the setup screen.

Tips:

- If the currently entered name has already existed, the system will pop up: “The server name exists!” Click [OK] to enter another name.

## B.1.4 DICOM Service Setting

You can set properties for Storage, Print, Worklist, MPPS, Storage Commitment, Query/Retrieve in DICOM service setting screen.

To enter the screen:

1. Press <Setup> to enter the Setup menu.
2. Move the cursor onto [Network Preset], the submenu pops up.
3. Select [DICOM Service], as shown in the following figure:

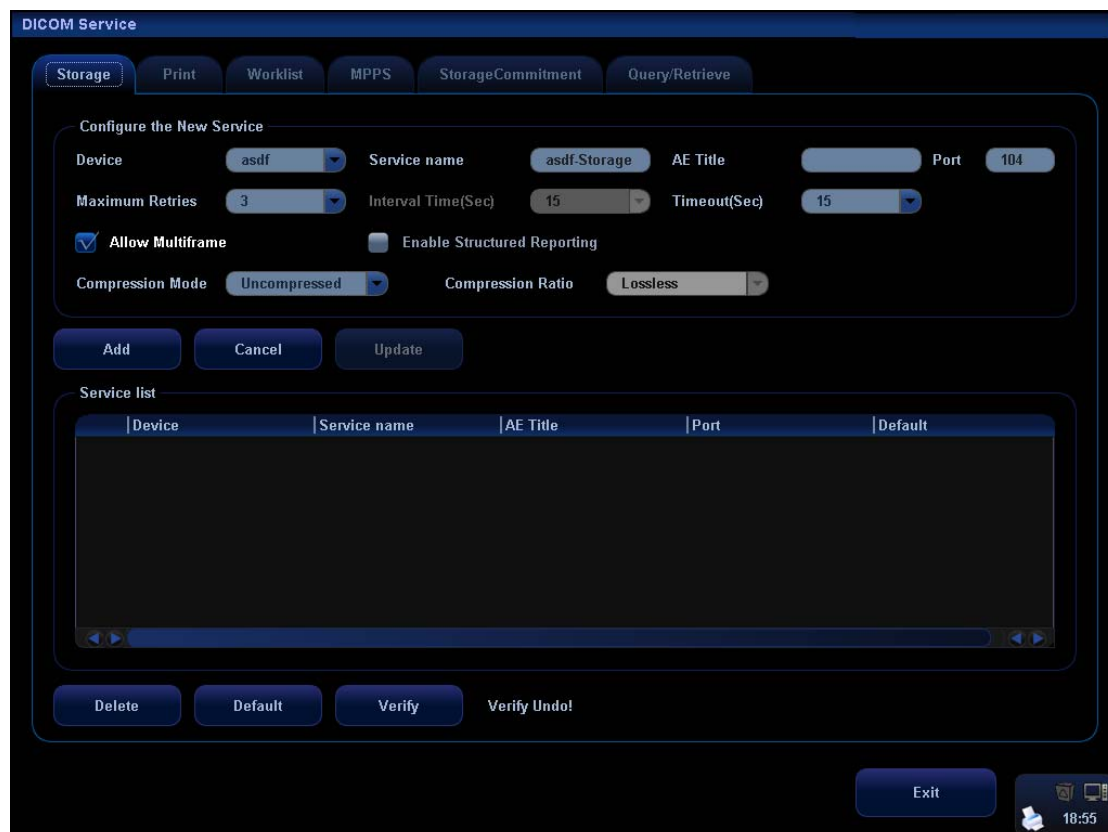

### B.1.4.1 Storage Setting

1. To enter the "Storage" page: "[Setup]→[Network Preset]→[DICOM Service Setting]→[Storage].
2. Select device in the drop-down list, the available devices are DICOM services already set in the system, enter the information.
  - Click [Add] to add the service to the Service list;
  - Select an item in the service list, change the parameters in the above area, and click [Update] to update the item in the service list; click [Cancel] to cancel changing.
  - Select an item in the service list, and click [Delete] to delete the service.
  - Select an item in the service list, and click [Default] to set the server to be the default service.
3. Select an item in the service list, and click [Verify] to verify the connection.
4. Click [Exit] to confirm the setting and exit the page.



DICOM storage setting items are described as follows:

- 1 Device: After you set the server (s) in DICOM Server Setting, the name (s) will appear in the drop-down list, select the name of the storage server.
- 2 Service Name: Default is xxx-Storage, and it can be modified.
- 3 AE Title: Application Entity title, which should be consistent with that of the storage server.
- 4 Port: DICOM communication port, which should be consistent with that of the storage server port.
- 5 Maximum Retries: 0-9.
- 6 Interval Time (s): Reserved feature.
- 7 Timeout: Refers to time after which the system will stop trying to establish a connection to the service. Value: 5—60s, in increments of 5s, and 15 by default.
- 8 Allow Multiframe: If SCP supports this function, then select it to perform multiframe storage.
- 9 Enable Structured Reporting: To enable or disable the structured report sending. (Reserved function)
- 10 Compression Mode: Select the compression mode: uncompressed, RLE, JPEG and JPEG2000.
- 11 Compression Ratio: Select the compression ratio of JPEG: lossless, low, medium and high.
- 12 Add: Click to add servers to the device list.
- 13 Cancel: Click to cancel parameter setting.
- 14 Update: Select an item in the service list, change the parameters in the above area, and click [Update] to update the item in the service list.
- 15 Delete: Click to delete the selected service in the service list.
- 16 Default: Select an item in the service list, click [Default] and you can see “Y” in the Default column.
- 17 Verify: Click to verify if the two DICOM application entities are normally connected.
- 18 Exit: Click to exit the setup screen.

Tips:

- RLE, JPEG and JPEG2000 are not supported by all SCPs. Please refer to the electronic file *DICOM CONFORMANCE STATEMENT* of the SCP to check whether SCP supports or not. Do not select these compression modes if the storage server doesn't support them. AE Title, Port should be consistent with those in the real server end.

#### **B.1.4.2 Print Service Setting**

1. Enter the “Print” page: “[Setup]→[Network Preset]→[DICOM Service Setting]→[Print].
2. Select device in the drop-down list, the available devices are DICOM services already set in the system, enter the information.
  - Click [Add] to add the service to the Service list.

- Select an item in the service list, change the parameters in the above area, and click [Update] to update the item in the service list; click [Cancel] to cancel changing.
  - Select an item in the service list, and click [Delete] to delete the service.
  - Select an item in the service list, and click [Default] to set the server to be the default service.
3. Select an item in the service list, and click [Verify] to verify the connection.
  4. Click [Exit] to confirm the setting and exit the page.

**DICOM Service**

Storage **Print** Worklist MPPS StorageCommitment Query/Retrieve

Configure the New Service

Device: asdf Service name: asdf-Print AE Title: Port: 104

Maximum Retries: 3 Interval Time(Sec): 15 Timeout(Sec): 15

Print Properties

Copies: 1 Settings: RGB Film Orientation: PORTRAIT Priority: HIGH

Film Size: 8INX10IN Display Format: STANDARD1,1 Configuration Info:

Medium Type: PAPER Destination: MAGAZINE

Min Density: 0 Max Density: 300 Magnification Type: NONE Trim: NO

Add Cancel Update

Service list

	Device	Service name	AE Title	Port	Default
1	asdf	asdf-Print		104	N

Delete Default Verify Verify Undo!

Exit 18:56

DICOM print setting items are described as follows:

- 1 Device: After you set the server (s) in DICOM Server Setting, the name (s) will appear in the drop-down list, select the name of the print server.
- 2 Service Name: Default is xxx-Print, and it can be modified.
- 3 AE Title: Application Entity title, which should be consistent with that of the print server.
- 4 Port: DICOM communication port, which should be consistent with that of the print server port.
- 5 Maximum Retries: 0-9.
- 6 Interval Time (s): Reserved feature.
- 7 Timeout: Refers to time after which the system will stop trying to establish a connection to the service. Value: 5—60s, in increments of 5s, and 15 by default.
- 8 Copies: Refer to copies of printed files. You can select among 1 through 5, or directly enter the number.

- 9 Settings: The system supports RGB (color printing) and MONOCHROME2 (black and white printing).  
Please select the type the printer supports.
- 10 Film Orientation: Select between LANDSCAPE and PORTRAIT
- 11 Priority: Specify printing task priority among HIGH, MED and LOW.
- 12 Film Size: Select film size among the selections listed in the drop-down list.
- 13 Display Format: Specify quantity of printed files. e.g. STANDARD\2, 3 indicates 6 images are printed for each page.
- 14 Configuration Info: Enter configuration information in the field.
- 15 Medium Type: Specify print medium: Paper, Clear Film, and Blue Film.
- 16 Destination: Specify where the file is exposed: MAGAZINE (stored in the magazine), or PROCESSOR (exposed in the processor).
- 17 Min Density: Enter the minimum density of the film
- 18 Max Density: Enter the maximum density of the film
- 19 Magnification Type: Select how the printer magnifies an image to fit the film.  
Replicate: interpolated pixels belong to duplicate of adjacent pixels.  
Bilinear: Interpolated pixels are generated from bilinear interpolations between adjacent pixels.  
Cubic: interpolated pixels are generated from cubic interpolations between adjacent pixels.  
None: without interpolation.  
Select how the printer magnifies an image to fit the film.
- 20 Trim: Specify whether you want a trim box to be printed around each image on the film: Yes or No.
- 21 Add: Click to add print service to the service list.
- 22 Cancel: Click to cancel parameter setting.
- 23 Update: Select an item in the service list, change the parameters in the above area, and click [Update] to update the item in the service list.
- 24 Delete: Click to delete the selected service in the service list.
- 25 Default: Select an item in the service list, click [Default] and you can see "Y" in the Default column.
- 26 Verify: Click to verify if the two DICOM application entities are normally connected.
- 27 Exit: Click to exit the screen.

Parameter setting should be consistent with the printer performance:

- For instance, if the printer cannot support film size to be "8IN\*10IN", please select the printer supported size.
- Settings: RGB is color printing and MONOCHROME2 is black and white printing.
- Medium Type: for black and white printing, usually Blue Film or Clear Film is used, and for color printing, Paper is usually used. For details, please refer to printer conformance statement.
- Change the setting if necessary.

### B.1.4.3 DICOM Worklist Setting

1. To enter the “Worklist” page: [Setup]→[Network Preset]→[DICOM Service Setting]→[Worklist].
2. Select device in the drop-down list, the available devices are DICOM services already set in the system, enter the information.
  - Click [Add] to add the service to the Service list.
  - Select an item in the service list, change the parameters in the above area, and click [Update] to update the item in the service list; click [Cancel] to cancel changing.
  - Select an item in the service list, and click [Delete] to delete the service.
  - Select an item in the service list, and click [Default] to set the server to be the default service.
3. Select an item in the service list, and click [Verify] to verify the connection.
4. Click [Exit] to confirm the setting and exit the page.

The Worklist settings are described in the following table:

- 1 Device: After you set the server (s) in DICOM Server Setting, the name (s) will appear in the drop-down list, select the name of the Worklist server.
- 2 Service Name: Default is xxx-Worklist, and it can be modified.
- 3 AE Title: Application Entity title, which should be consistent with that of the Worklist server port.
- 4 Port: DICOM communication port, which should be consistent with that of the Worklist server port.
- 5 Maximum Retries: Reserved feature.

- 6 Interval Time (s): Reserved feature.
- 7 Timeout: Refers to time after which the system will stop trying to establish a connection to the service. Value: 5—60s, in increments of 5s, and 15 by default.
- 8 Scheduled Station: To set the AE Title of the scheduled station. For example, if the AE Title of the Worklist server is M5, then the scheduled station AE Title here should be M5.
- 9 Add: Click to add the Worklist service to the service list.
- 10 Cancel: Click to cancel parameter setting.
- 11 Update: Select an item in the service list, change the parameters in the above area, and click [Update] to update the item in the service list.
- 12 Delete: Click to delete the selected service in the service list.
- 13 Default: Select an item in the service list, click [Default] and you can see “Y” in the Default column.
- 14 Verify: Click to verify if the two DICOM application entities are normally connected.
- 15 Exit: Click to exit the screen.

Tips:

- In terms of “Scheduled Station AE Title”, if you set this item in the Worklist server, then “Scheduled Station AE Title” configured here should be consistent with the one set in the server.  
For example, when you set “Scheduled Station AE Title” in the Worklist server as M5 (this means you assigned the scheduled exam to M5), then both “Scheduled Station AE Title” and “AE Title” in the ultrasound system configuration should be M5.

#### **B.1.4.4 MPPS Setting**

1. Enter the “MPPS” page: “[Setup]→[Network Preset]→[DICOM Service Setting]→[MPPS].
2. Select device in the drop-down list, the available devices are DICOM services already set in the system, enter the information.
  - Click [Add] to add the service to the Service list.
  - Select an item in the service list, change the parameters in the above area, and click [Update] to update the item in the service list; click [Cancel] to cancel changing.
  - Select an item in the service list, and click [Delete] to delete the service.
  - Select an item in the service list, and click [Default] to set the server to be the default service.
3. Select an item in the service list, and click [Verify] to verify the connection.
4. Click [Exit] to confirm the setting and exit the page.

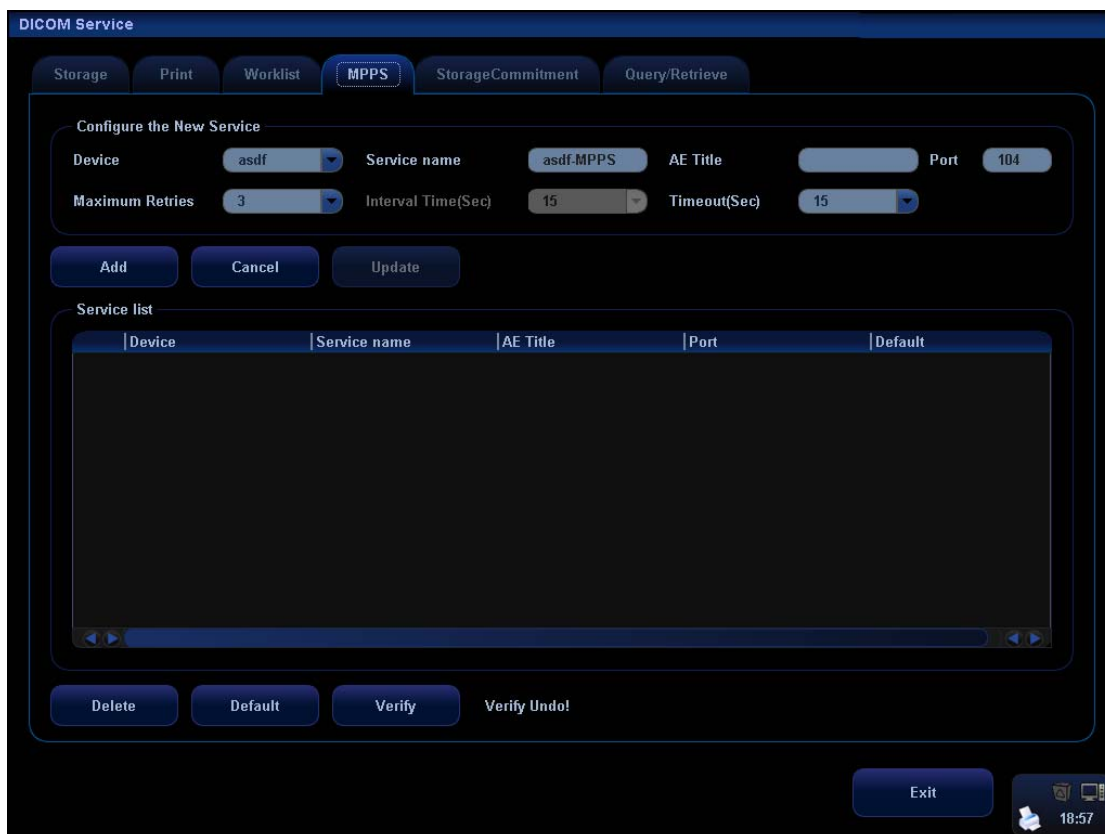

MPPS setting items are described as follows:

- 1 Device: After you set the server (s) in DICOM Server Setting, the name (s) will appear in the drop-down list, select the name of the MPPS server.
- 2 Service Name: Default is xxx-MPPS, and it can be modified.
- 3 AE Title: Application Entity title, which should be consistent with that of the MPPS server.
- 4 Port: Here, the port should be consistent with that of the MPPS server.
- 5 Maximum Retries: Reserved feature.
- 6 Interval Time (s): Reserved feature.
- 7 Timeout: Refers to time after which the system will stop trying to establish a connection to the service. Value: 5—60s, in increments of 5s, and 15 by default.
- 8 Add: Click to add services to the service list.
- 9 Cancel: Click to cancel parameter setting.
- 10 Update: Select an item in the service list, change the parameters in the above area, and click [Update] to update the item in the service list.
- 11 Delete: Click to delete the selected service in the service list.
- 12 Default: Select an item in the service list, click [Default] and you can see “Y” in the Default column.
- 13 Verify: Click to verify if the two DICOM application entities are normally connected.

- 14 Click to exit the screen.

### B.1.4.5 Storage Commitment Setting

1. Enter the "Storage Commitment" page: "[Setup]→[Network Preset]→[DICOM Service Setting]→ [Storage Commitment].
2. Select device in the drop-down list, the available devices are DICOM services already set in the system, enter the information.
  - Click [Add] to add the service to the Service list.
  - Select an item in the service list, change the parameters in the above area, and click [Update] to update the item in the service list; click [Cancel] to cancel changing.
  - Select an item in the service list, and click [Delete] to delete the service.
  - Select an item in the service list, and click [Default] to set the server to be the default service.
3. Select an item in the service list, and click [Verify] to verify the connection.
4. Click [Exit] to confirm the setting and exit the page.

DICOM storage commitment setting items are described as follows:

- 1 Device: After you set the server (s) in DICOM Server Setting, the name (s) will appear in the drop-down list, select the name of the storage commitment server.
- 2 Service Name: Default is xxx-SC, and it can be modified.
- 3 AE Title: Application Entity title, which should be consistent with that of the storage commitment server.
- 4 Port: DICOM communication port, which should be consistent with that of the

- 
- storage commitment server port.
- 5 Maximum Retries: Reserved feature.
  - 6 Interval Time (s): Reserved feature.
  - 7 Timeout: Refers to time after which the system will stop trying to establish a connection to the service. Value: 5—60s, in increments of 5s, and 15 by default. After image storage commitment is sent, the system will close the connection with the server.
  - 8 Associated Storage Service: To select the already configured DICOM storage service in the system.
  - 9 Add: Click to add storage commitment service to the service list.
  - 10 Cancel: Click to cancel parameter setting.
  - 11 Update: Select an item in the service list, change the parameters in the above area, and click [Update] to update the item in the service list.
  - 12 Delete: Click to delete the selected service in the service list.
  - 13 Default: Select an item in the service list, click [Default] and you can see “Y” in the Default column.
  - 14 Verify: Click to verify if the two DICOM application entities are normally connected.
  - 15 Exit: Click to exit the screen.

#### **B.1.4.6 Query/Retrieve Setting**

1. Enter the “Query/ Retrieve” page: “[Setup]→[Network Preset]→[DICOM Service Setting]→ [Query/ Retrieve].
2. Select device in the drop-down list, the available devices are DICOM services already set in the system, enter the information.
  - Click [Add] to add the service to the Service list.
  - Select an item in the service list, change the parameters in the above area, and click [Update] to update the item in the service list; click [Cancel] to cancel changing.
  - Select an item in the service list, and click [Delete] to delete the service.
  - Select an item in the service list, and click [Default] to set the server to be the default service.
3. Select an item in the service list, and click [Verify] to verify the connection.
4. Click [Exit] to confirm the setting and exit the page.



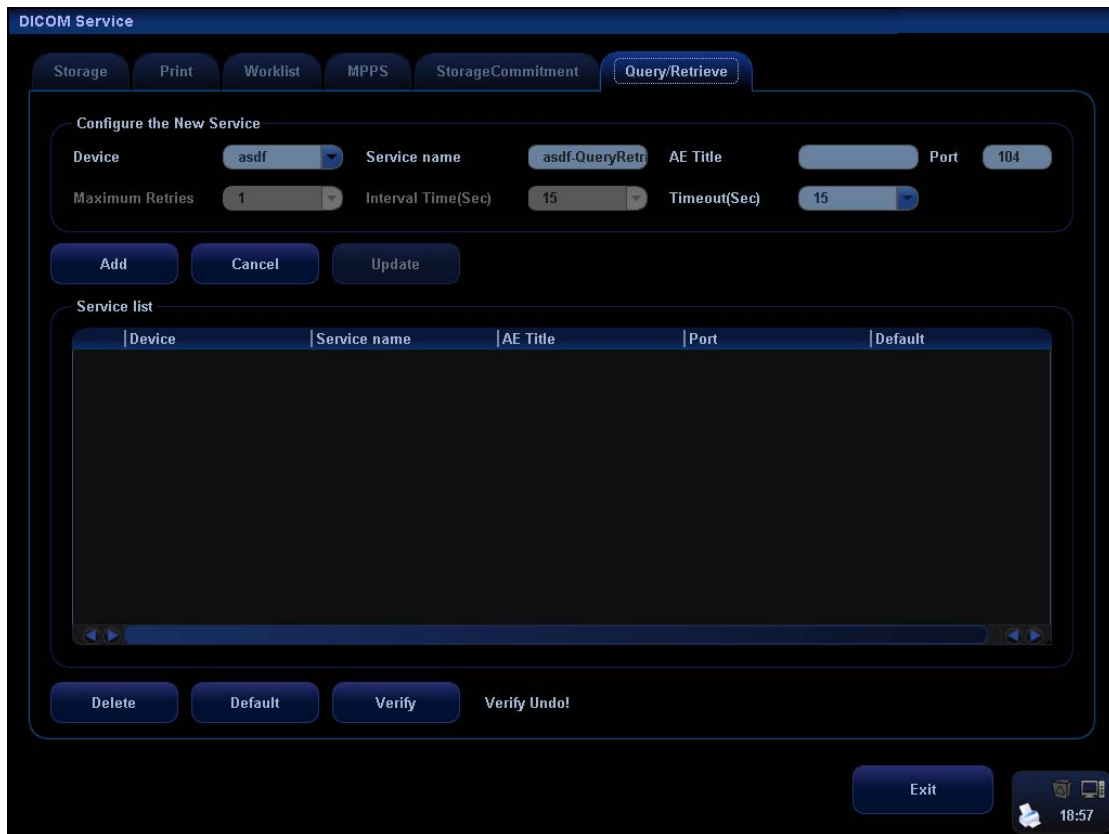

DICOM query/retrieve setting items are described as follows:

- 1 Device: After you set the server (s) in DICOM Server Setting, the name (s) will appear in the drop-down list, select the name of the query/retrieve server.
- 2 Service Name: Default is xxx-QueryRetrieve, and it can be modified.
- 3 AE Title: Application Entity title, which should be consistent with that of the Query/Retrieve server.
- 4 Port: DICOM communication port, which should be consistent with that of the query/retrieve server port.
- 5 Maximum Retries: Reserved feature.
- 6 Interval Time (s): Reserved feature.
- 7 Timeout: Refers to time after which the system will stop trying to establish a connection to the service. Value: 5–60s, in increments of 5s, and 15 by default. After information or image is being retrieved for 15s, the system will close the connection with the server if no other information or image is being retrieved.
- 8 Add: Click to add services to the service list.
- 9 Cancel: Click to cancel parameter setting.
- 10 Update: Select an item in the service list, change the parameters in the above area, and click [Update] to update the item in the service list.
- 11 Delete: Click to delete the selected service in the service list.
- 12 Default: Select an item in the service list, click [Default] and you can see “Y” in the Default column.

- 13 Verify: Click to verify if the two DICOM application entities are normally connected.
- 14 Exit: Click to exit the screen.

## B.2 Verify Connectivity

If you want to verify connectivity (not a must), you can click [Verify] button on the pages of DICOM Service screen respectively.

- If the verification succeeds, it will prompt “xxx Verify Succeed”.
- Otherwise, it prompts “xxx Verify Failed”.

If verification failed, the possible causes may be:

The ultrasound machine can't communicate normally with the server. Please check if the cable is properly connected; or,

Check if the IP of the server is configured in the same segment with that of the ultrasound machine; or,

Check if the network adapter, the router, the exchanger and the HUB are normally working.

Tips:

- Not all the SCPs can support verification; please consult SCP belongings to confirm whether SCP can support this service. If not, the verification won't pass.

## B.3 DICOM Service

### B.3.1 DICOM Storage

DICOM Storage is used to send image(s) to DICOM storage server for storage.

To perform DICOM image storage:

- Send image to DICOM Storage server in iStation/Review/main screens.
  - Send images to DICOM Storage server by shortcut key.
  - To send images to DICOM Storage server after an exam ends automatically.
- Send image to DICOM Storage server in iStation/Review/main screens.
1. Select image(s):
    - Press <iStation> to enter the iStation screen, click to select an exam record in the list, where thumbnails are displayed in the thumbnail area in the lower part of the screen, and then click to select a thumbnail or several thumbnails. Or,
    - Press <Review> to enter the Review screen, click to select an image or several images. Or,
    - On the main screen, select a thumbnail or several thumbnails.
  2. On the iStation/Review screen, click the corresponding [Send To] button, or, on the main screen, click  at the right side of Thumbnail area. The following dialogue box pops up:

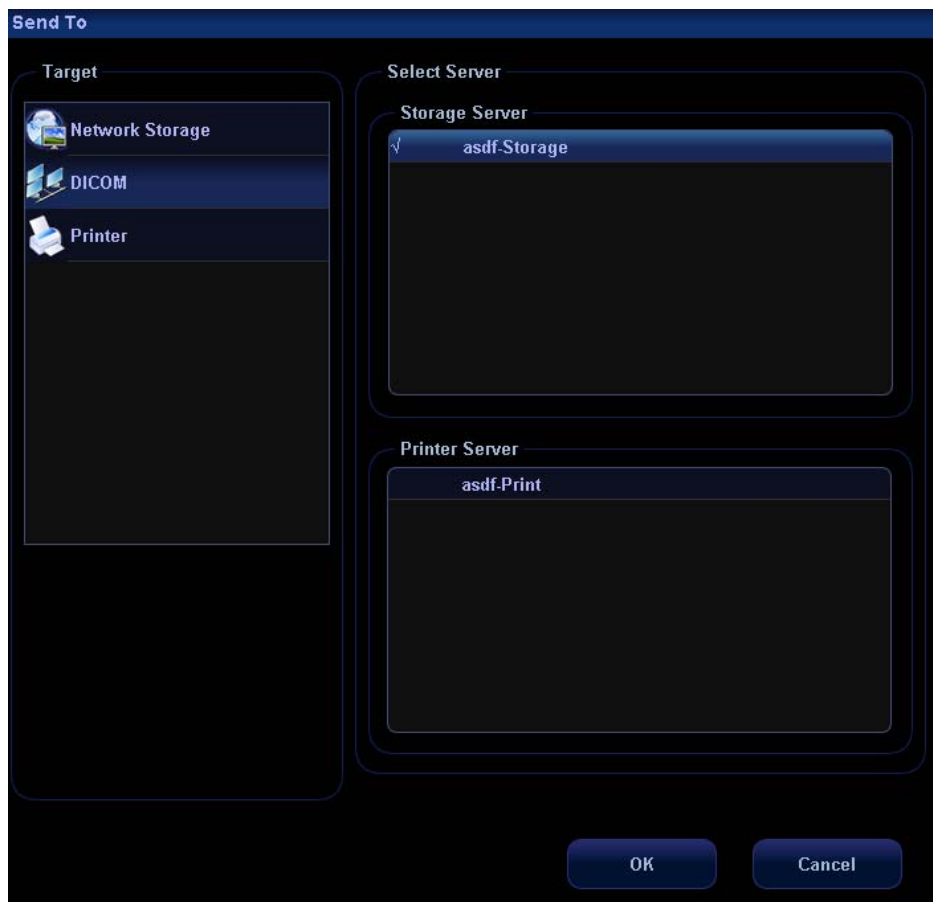

3. Select DICOM in the “Target” list; select a server in the “Storage Server” list.
4. Click [OK] to start the sending.

■ Send images to DICOM Storage server by shortcut key.

1. You can define shortcut keys on the control panel to send images to DICOM server for storage. Available user-defined shortcut keys are:
  - Save Single Frame Image to DICOM Server
  - Save Multi-frame Image to DICOM Server
2. You can select [Print] key, [Save] key, [F1] key, [F2] key, [F3] key, [F4] key on the control panel, or left and right footswitch keys as user-defined keys.
3. Define the shortcut key.
  - a) Enter the key configuration page: [Setup]→[System Preset]→[Key Config].
  - b) Assign functions to the desired keys.
  - c) Click [OK] to confirm.
  - d) Select [Return] in the [Setup] menu to take effect.

For details, please refer to “Chapter 17.2 System Preset”.

4. To set default server:
  - a) To enter the “Storage” page: “[Setup]→[Network Preset]→[DICOM Service Setting]→[Storage].
  - b) Select an item in the service list, and click [Default] to set the server to be the default service. As shown in figure below.

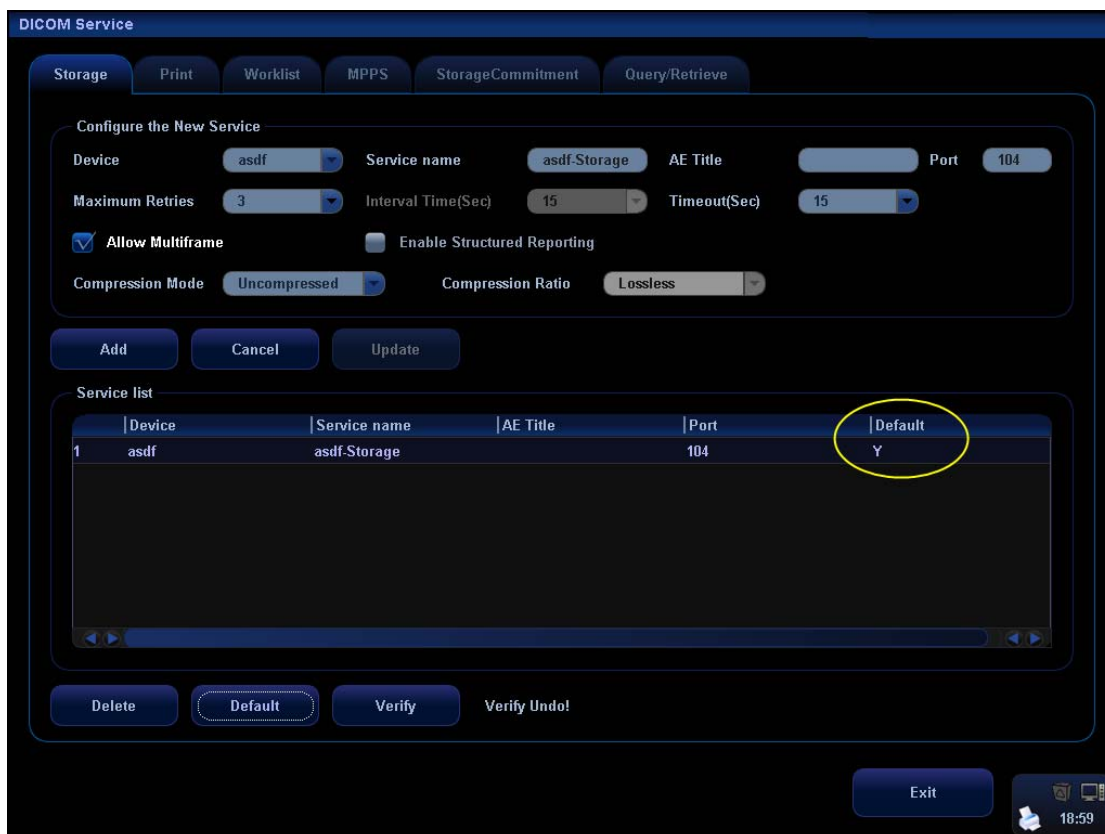

- c) Click [Exit] to exit DICOM Storage page, and click [Return] in the Setup menu.
5. Press XX key on the control panel (which has been assigned as the shortcut key for “Save Single Frame Image to DICOM Server”), the image is frozen. The system captures the current screen image and sends it to the storage server as the single-frame file. Or, press XX on the control panel (assigned as shortcut key for “Save Multi-frame Image to DICOM Server”), the system will freeze the image and save it as multi-frame file and send it to the storage server.)
- To send images to DICOM Storage server after an exam ends automatically:
1. Enter [Setup] (by pressing <Setup>)->[System Preset]->[General Preset].
  2. Check “Send/Print Image after End Exam”. As shown in figure below.

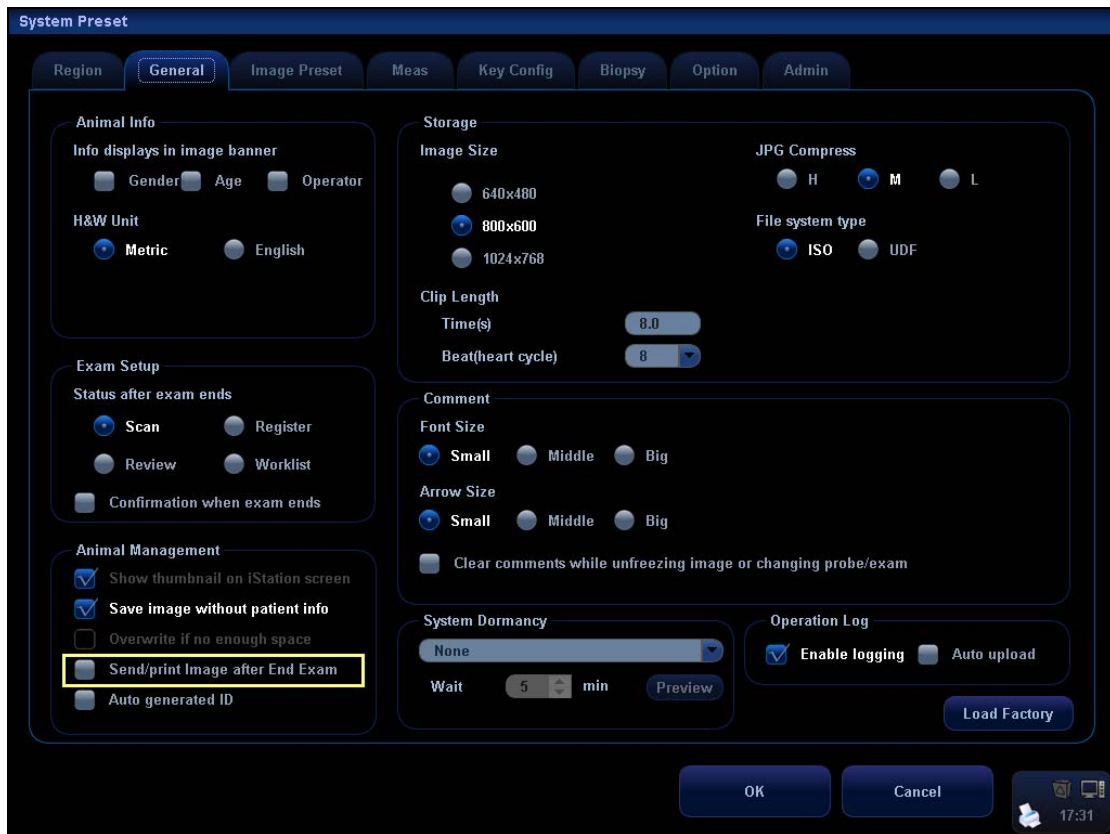

3. Set a default server as described before.
4. After finishing the setting, you can perform image scanning, and each time you press <End Exam>, the system will send images to the default DICOM storage server.

## B.3.2 DICOM Print

DICOM Print is used to send image(s) to DICOM print server to print images.

To perform DICOM image print:

- Send image to DICOM Print server in iStation/Review/main screens.
  - Send images to DICOM Print server by shortcut key.
  - To send images to DICOM Print server after an exam ends automatically.
- Send image to DICOM Print server in iStation/Review/main screens.
1. Select image file: operation is similar to operations in “Send image to DICOM Storage server in iStation/Review/main screens”.
  2. On the iStation/Review screen, click the corresponding [Send To] button, or, on the main screen, click  at the right side of Thumbnail area. The following dialogue box pops up:

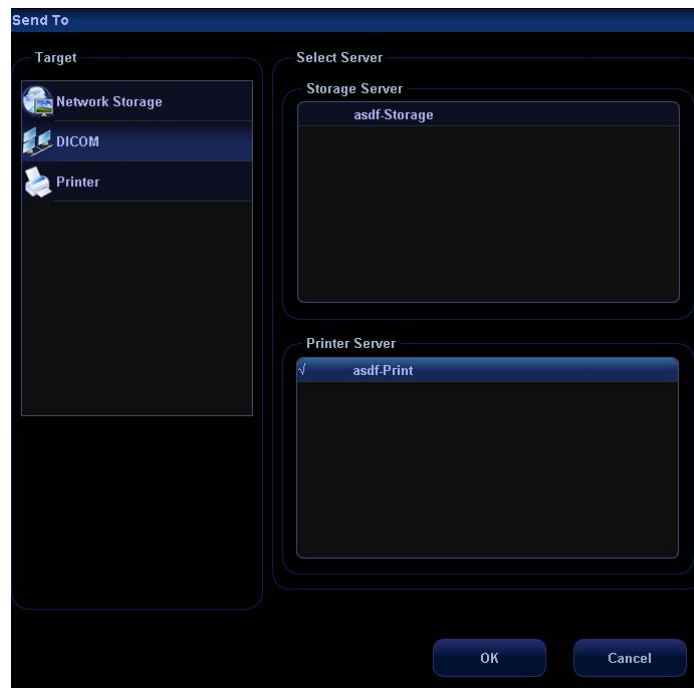

3. Select DICOM in the “Target” list; select a server in the “Print Server” list.
4. Click [OK] to start the sending.

■ Send images to DICOM Print server by shortcut key.

1. You can send single frame image or multi-frame images to DICOM Print server by shortcut key:
  - Print Single Frame Image to DICOM Server
2. You can select [Print] key, [Save] key, [F1] key, [F2] key, [F3] key, [F4] key on the control panel, or left and right footswitch keys as user-defined keys.
3. Define the short-cut key: operation is similar to operations in “Send images to DICOM Storage server by shortcut key”.
4. Set the default server: operation is similar to operations in “Send images to DICOM Storage server by shortcut key”.
5. Press XX on the control panel (assigned as the shortcut key for “DICOM Print Single Frame Image to DICOM Server), then the system sends the image to the print server.

■ Send to DICOM print when ending the exam automatically:

1. Enter [Setup] (by pressing <Setup>)→[System Preset]→[General Preset].
2. Check “Send/Print Image after End Exam”. As shown in figure below.

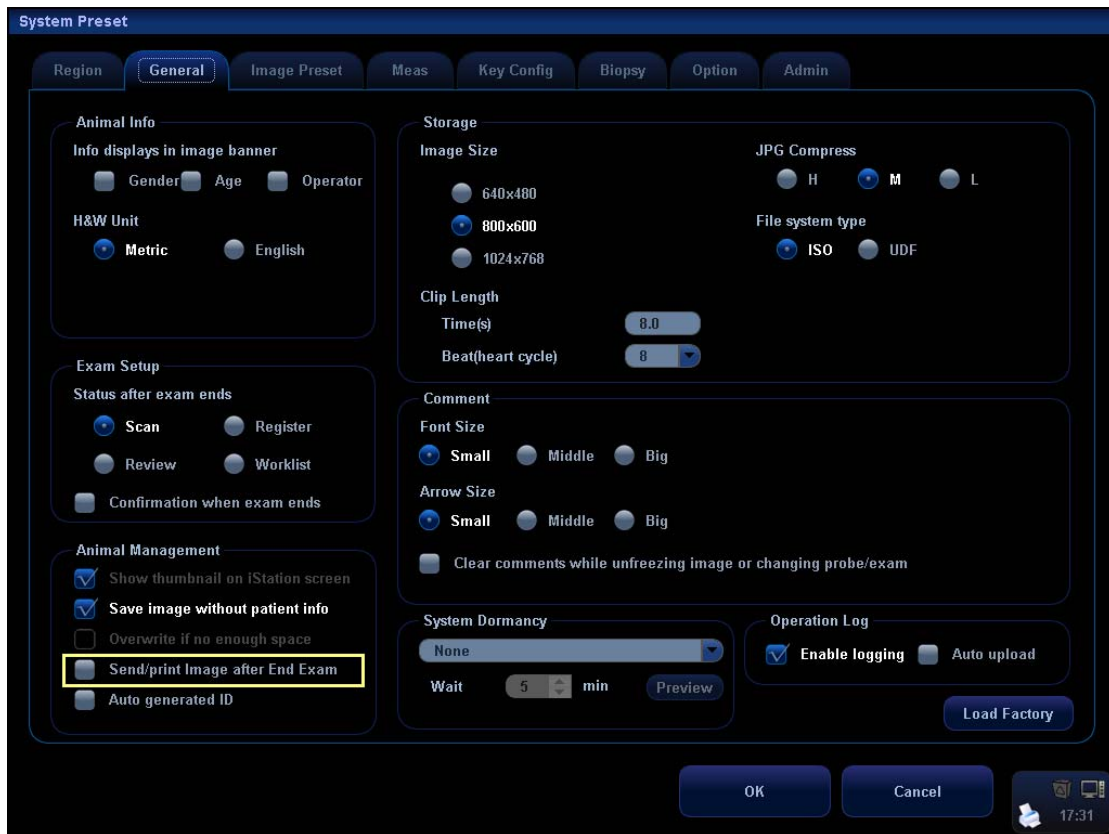

3. Set a default server as described before.
4. After finishing the setting, you can perform image scanning, and each time you press <End Exam>, the system will send images to the default DICOM print server.

### B.3.3 DICOM Worklist

This function can enable you to query animal records from Worklist server, and import the desired information to the system, whether to start an exam or not.

- 1 Press the <Info> key to open the Animal Info screen.
- 2 Click [WorkList] to enter the WorkList page.

- 3 This function can enable you to query animal records from Worklist server, and import the desired information to the system, whether to start an exam or not.  
Set query criteria among Patient ID, Patient Name, Accession #, Search Key, Worklist Server or Exam Date. The exam date is the current date by default.  
Click [Query].  
The scheduled patients, which meet the criteria, are displayed in the lower part of the screen.  
After you finish the first query, you can perform the second query basing on the preview results. The scheduled patients in the list will update in real time.
- 4 Select the desired animal record in the displayed patient list, and,  
Select the desired animal and click [Start Exam], the animal information is imported into the system and then an exam is started.  
Click [Transfer], the animal information is imported into the [Animal Info] screen and it is opened. After you edit the animal information in the [Animal Info] screen, select [OK] to start a new exam.
- 5 To show animal information in details:
  - a) Click to select an animal record.
  - b) Click [Show Detail] to view the detailed animal information and properties.
- 6 In the off-line status, you can:
  - Perform a second query; or,
  - Click [Show Detail] to view the animal information in details.

Use the automatic query function via Worklist server

1. Enter [Setup][Network Preset][DICOM Service Setting][Worklist].



2. Select the server from the drop-down list to be default.
3. Click [Exit] and click [Return] in the Setup menu.
4. Press <Info> to open the Animal Info screen.
5. Click [WorkList] to enter the WorkList page.
6. The system queries intraday patients via Worklist server automatically and the animal records will appear in the list.

### B.3.4 MPPS

MPPS is used to send exam status information to the configured DICOM server. This can acquaint other medical devices with the current exam progress and facilitate better arrangements for patients.

- After you preset the Worklist server and MPPS server (for details, please refer to “B.1.4 DICOM Service Setting”), if the system query animal information from Worklist server to begin exam, it will send exam status information to MPPS server of when the exam is undergoing or ended. If the sending fails, the system resend automatically.

The status information is described as follows:

- When you start a new exam, the system sends status information “In Progress” to MPPS server.
- When the exam is ended, the system sends status information “Completed” to MPPS server.
- When an exam is cancelled, the system sends status information “Discontinued” to MPPS server.
- When an ended exam is activated, the system sends status information “In Progress” to MPPS server.

### B.3.5 Storage Commitment

Storage commitment is used to confirm whether images are successfully stored to the DICOM server.

Before storage commitment, you should set a default storage commitment server.

- Storage commitment after sending images on iStation screen
  - 1 Open iStation screen: press <iStation> or press <Info> and click [iStation].
  - 2 Select an exam record (contains images) in iStation screen.
  - 3 Click [Send To] to enter the screen.

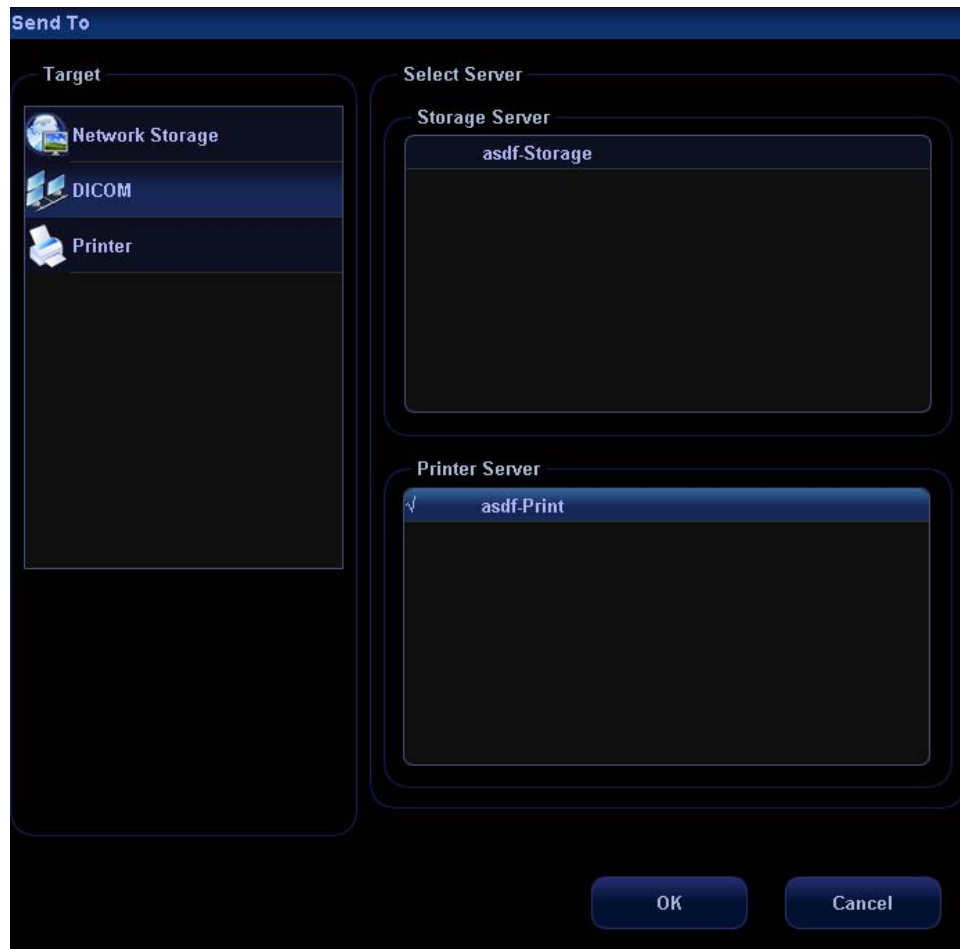

- 4 Select "DICOM" in the "Target" box on the left side.
  - 5 Select DICOM Storage server in the "Storage Server" box on the right side.
  - 6 Click [OK] to start sending. The system will send all the images stored in the exam record to the storage server, meanwhile, it will send storage commitment to the storage commitment server.
- To send storage commitment after an exam ends automatically
- 1 Enter [Setup] (by pressing <Setup>)→[System Preset]→[General Preset].
  - 2 Check "Send/Print Image after End Exam". As shown in figure below.

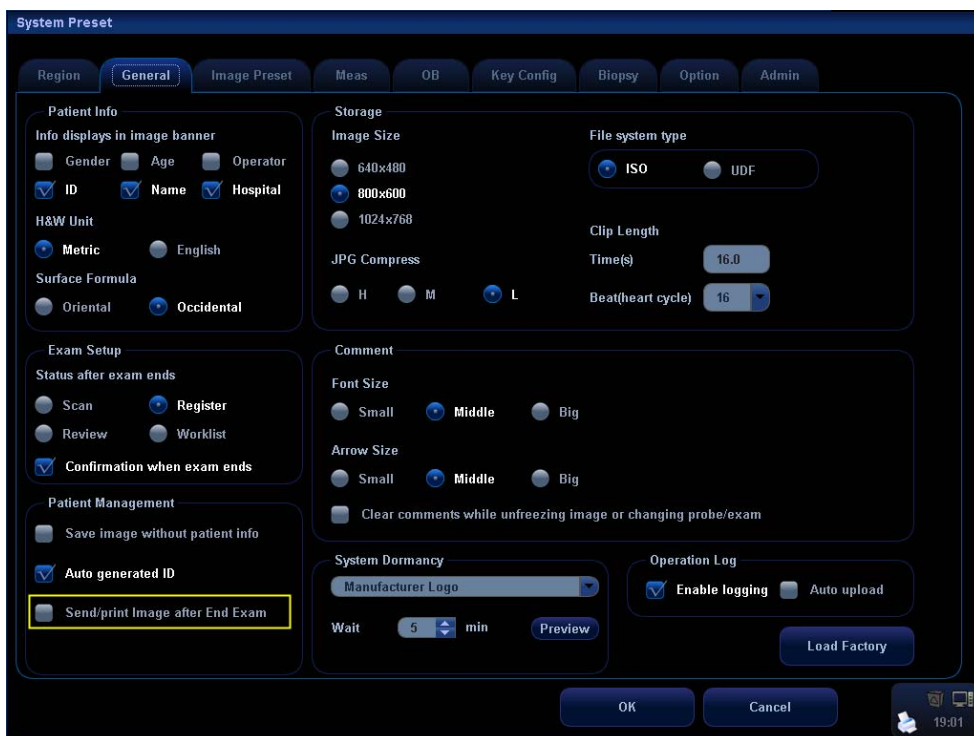

- 3 Enter “DICOM Service Setting” page, and set default storage server and storage commitment server in “Storage” and “Storage Commitment” page (for details, please refer to “B.1 DICOM Preset”)
- 4 After finish the above settings, every time you press <End Exam>, the system will send data to the default DICOM storage server for storage and storage commitment to default DICOM storage commitment server.

If images are successfully send to the storage server, the storage commitment server will return information about the successful image storage. In the iStation screen, you will see a tick “√” marked on in the list below .

Storage commitment is confined to the whole exam, while each image sending will not be indicated.

**NOTE:** Multi-frame storage is not allowed if “Allow Multiframe” is not selected ([Setup][Network Preset][DICOM Service Setting]“Storage”). For example, if there is multi-frame file in the exam to be sent, then only single-frame image storage will be performed, and after the storage is completed, there is no “√” marked in the list below in the iStation screen.

### B.3.6 Query/ Retrieve

The query/ retrieve function is employed to query and retrieve the animal exam records in a designated server.

After setting the DICOM query/ retrieve server, you can perform the query/ retrieve function in iStation screen.

- 1 Open iStation screen: press <iStation> or press <Info> and click [iStation].
- 2 Click [Query/ Retrieve] to enter the following screen.

The screenshot shows a 'Query/Retrieve' window with the following sections:

- Server and Service:** Source (dropdown), Destination (Local Host dropdown).
- Query:** Patient ID, Patient Name, Accession #, Exam Date (DD/MM/YYYY To DD/MM/YYYY), Search Key (Study ID dropdown).
- Buttons:** Query, Clear.
- Patient(Source):** 0 records are listed. Table with columns: Patient ID, Name, Accession #, Exam Description, Exam Date/Time, Gender, DOB.
- Buttons:** Select All, Deselect All, Retrieve, Cancel.
- Patient(Destination):** 0 records are listed. Table with columns: Patient ID, Name, Accession #, Exam Description, Exam Date/Time, Content, Gender, DOB.
- Buttons:** Exit.
- System Tray:** 19:07.

- 3 Select the server in “Server and Service” area for the source and the destination.
- 4 Enter the query information, such as patient name, patient ID, accession number, exam time and select keyword for searching.  
Click [Clear] to empty the entered query information.
- 5 Click [Query], the system performs the query to the server and lists out the result into the patient (source) list.  
You can perform a second query based on the preview results.
- 6 Select one or more animal records according to the actual situation.  
Click [Select All] to select all the animal records listed.  
Click [Deselect All] to deselect all the animal records listed.
- 7 Click [Retrieve] to retrieve the animal records in the DICOM query/ retrieve server into the system.
- 8 Click [Exit], you can see the retrieved animal records listed in the iStation screen.

## B.4 DICOM Media Storage

The system supports to save animal data to the external media in DCM format. Meanwhile, in the system; you can view the saved DCM files from external media. You cannot perform media storage of the current animal information.

### ■ Media storage:

1. Select animal record(s) in the iStation screen.
2. Click [Backup] to enter the following dialogue box:



3. Select destination in the drop-down list (CD/DVD/USB disk) and select “DICOM Format”.
4. Click [Backup] to begin storage.

If the backup succeeded, there will be a tick marked in the Backup list in iStation screen; otherwise, no tick is marked.

Tips:

There should be no DICOMDIR/ DICMIMG/IHE\_PDI files in the external storage media of the same name with the one being backed up, otherwise, the backup can't proceed.

Please make sure there is enough storage space; otherwise, backup may fail due to space shortage.

■ Media review:

1. Connect the external media with DCM files to the system.
2. Select the data source in iStation screen, and the visible data will be shown.

If there are several kinds of data on the media, the system will ask you to select the format, as shown in the following:



■ Data Restore:

If the DICOM format data is backed up to external media, you can restore the data to the system from the media.

1. Review the data stored in the external media.
2. Select the data to be restored in iStation.
3. Click [Restore] in the iStation screen.

**NOTE:** Only the system accessible media can be selected.

### ■ Media Storage Update

When exam of DICOM media storage changes (image or information is changed), the system supports to update the saved DICOMDIR file. Enter iStation screen, and perform media storage sending again, then the data will be updated.

## B.5 Showcase Recording

Showcase software can be employed for DICOM image file viewing.

When record DICOM files (both files backed up as DICOMDIR format and files transformed into DICOM files by clicking [Send To]), the Showcase can be recorded to the CDs together.

- If you send file to optical disk (in DCM format), Showcase software is burned into the disk automatically.
- After you check “DICOM format” when burning file to disk, the system prompts “Attach DICOM Viewer” check box, and after you check this, Showcase software is burned to optical disk.

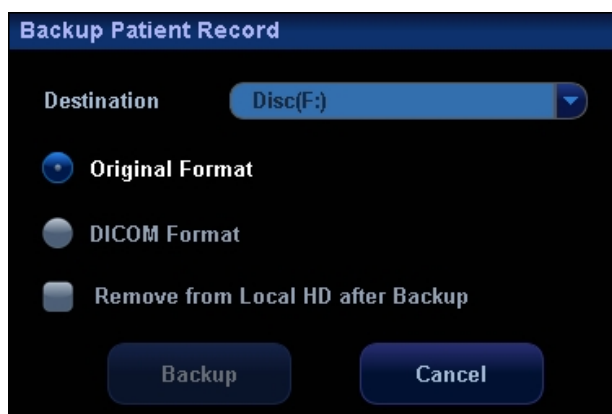

Insert a CD containing showcase software, the showcase runs automatically.

**NOTE:** To view the DCM files successfully, it is suggested to install NET Framework (Visual Studio.Net) of a version later than 2.0, if your computer was installed with TortoiseSVN.

## B.6 DICOM Task Management

DICOM Task Management is used to view task progress or manage tasks after sending images for storage, print, or media storage.

Please refer to “16.8 Patient Task Management” for details.

# Appendix C Remote Control and Net Update

Remote control (remote desktop) is a function provided by Mindray with service engineer monitoring and controlling the ultrasound system in real-time so as to handle malfunctions or for instruction.

Using net update, you can update the system by downloading upgrade software from the manufacturer sever.

Before performing remote control or net update, the ultrasound system should be connected into Internet.

## C.1 Network Connection

1. Connect the ultrasound system into Internet.
2. Enter the “Local TCP/IP” screen by pressing <Setup>-[Network Preset]-[Local TCP/IP], set the network properties of the ultrasound system.
3. Click [OK] to exit network property setting.
4. Click [Exit] to exit preset.

## C.2 Remote Control

1. Press <Setup> to enter the [Setup] menu.
2. Click [Maintenance] to enter the screen.
3. Click [Remote Desktop] to enter the “Remote Service” dialogue box.
4. Set the password of 1-8 characters, and inform the service engineer of the password.
5. Select “Enable Remote Control”.
6. Click [Run Service].
7. Check the IP address of the ultrasound system, inform the service engineer of the IP address.
8. Then service engineer can use the remote control function to check and operate the ultrasound system.
9. If you want to stop remote control, click  icon on the lower right corner, and click OK in the popped up dialogue box.

## C.3 Net Update

1. Acquire the License file from the service engineer.
2. Press <Setup> to enter the [Setup] menu.
3. Click [Maintenance] to enter the screen.
4. Click [Net Update] to enter the “Load File” dialogue box and load the License file.

5. Click [OK] and the ultrasound system will search the updating server automatically and downloading upgrade software.

After loading is completed, the system will prompt to update or not, click [OK] to start update.



# Appendix D Ultrasound

## System Software

### Restoring

The Special System Recover Disc is only used in USA.

Using the Special System Recover Disc provided by this system can restore the system software and solve some simple troubles.

Note: Before using the special system recover software, please contact your service representative.

Preconditions:

System can enter into the ultrasound operation system, but some of the functions can not be normally operated.

If you need to restore the Windows XP system, please contact your service representative.

Operations:

1. Run the ultrasound system; enter into the normal scanning mode.
2. Press “Ctrl +T” on the control panel to open the following dialogue box:

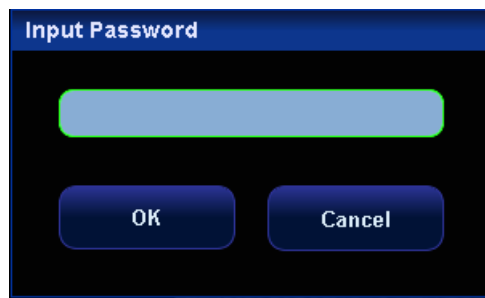

3. Enter the correct password in the popped out dialogue box, then select the [OK] button to exit the dialogue box.
4. Key in “shellapp off” in the “Memory Debugger>” column on the lower part of the screen, then press [Enter] key.
5. Press the power switch on the control panel and the [System Exit] screen appears.





6. Click  button to turn off the system, and then restart it after more than 20 seconds.
7. After the machine is booted, it will directly enter into the Windows XP interface.
8. Put the Special System Recover Disc into the CD-ROM drive, the setup procedure will be automatically started.
9. A series programs will be recovered, you need wait.
10. When it prompts "System need reboot!" Press any key to continue...; press any key and the system will return to Windows XP interface, then you can take out the CD.
11. Shut down the machine.
12. Restart the system after more than 20 seconds, and it will enter into the recovered ultrasound system.

# Appendix E Electrical Safety

## Inspection

The following electrical safety tests are recommended as part of a comprehensive preventive maintenance program. They are a proven means of detecting abnormalities that, if undetected, could prove dangerous to either the animal or the operator. Additional tests may be required according to local regulations.

All tests can be performed using commercially available safety analyzer test equipment. These procedures assume the use of a 601PROXL International Safety Analyzer or equivalent safety analyzer. Other popular testers complying with IEC 60601-1 used in Europe such as Fluke, Metron, or Gerb may require modifications to the procedure. Follow the instructions of the analyzer manufacturer.

**The electrical safety inspection should be periodically performed every two years.** The safety analyzer also proves to be an excellent troubleshooting tool to detect abnormalities of line voltage and grounding, as well as total current loads.

### E.1 Power Cord Plug

#### E.1.1 The Power Plug

Test Item		Acceptance Criteria
The power plug	The power plug pins	No broken or bent pin. No discolored pins.
	The plug body	No physical damage to the plug body.
	The strain relief	No physical damage to the strain relief. No plug warmth for device in use.
	The power plug	No loose connections.
The power cord		No physical damage to the cord. No deterioration to the cord.
		For devices with detachable power cords, inspect the connection at the device.
		For devices with non-detachable power cords, inspect the strain relief at the device.

## E.2 Device Enclosure and Accessories

### E.2.1 Visual Inspection

Test Item	Acceptance Criteria
The enclosure and accessories	No physical damage to the enclosure and accessories.
	No physical damage to meters, switches, connectors, etc.
	No residue of fluid spillage (e.g., water, coffee, chemicals, etc.).
	No loose or missing parts (e.g., knobs, dials, terminals, etc.).

### E.2.2 Contextual Inspection

Test Item	Acceptance Criteria
The enclosure and accessories	No unusual noises (e.g., a rattle inside the case).
	No unusual smells (e.g., burning or smoky smells, particularly from ventilation holes).
	No taped notes that may suggest device deficiencies or operator concerns.

## E.3 Device Labeling

Check the labels provided by the manufacturer or the healthcare facility are present and legible.

- Main unit label
- Integrated warning labels

## E.4 Protective Earth Resistance

- Plug the probes of the analyzer into the device's protective earth terminal and protective earth terminal of the AC power cord.
- Test the earth resistance with a current of 25 A.
- Verify the resistance is less than limits.

### ■ LIMITS

ALL COUNTRIES R = 0.2  $\Omega$  Maximum

## E.5 Earth Leakage Test

Run an Earth Leakage test on the device being tested before performing any other leakage tests.

The following outlet conditions apply when performing the Earth Leakage test.

- normal polarity( Normal Condition);
- reverse polarity( Normal Condition);
- normal polarity with open neutral(Single Fault Condition);
- reverse polarity with open neutral(Single Fault Condition).

### ■ LIMITS

For UL60601-1,

- 300  $\mu$ A in Normal Condition.
- 1000  $\mu$ A in Single Fault Condition.

For IEC60601-1,

- 500  $\mu$ A in Normal Condition.
- 1000  $\mu$ A in Single Fault Condition.

## E.6 Enclosure Leakage Test

The following outlet conditions apply when performing the Enclosure Leakage test.

- normal polarity( Normal Condition);
- reverse polarity( Normal Condition);
- normal polarity with open neutral(Single Fault Condition);
- reverse polarity with open neutral(Single Fault Condition);
- normal polarity with open earth(Single Fault Condition);
- reverse polarity with open earth(Single Fault Condition).

### ■ LIMITS

For UL60601-1,

- 100 $\mu$ A in Normal Condition.
- 300  $\mu$ A in Single Fault Condition.

For IEC60601-1:

- 100 $\mu$ A in Normal Condition.
- 500  $\mu$ A in Single Fault Condition.

## E.7 Patient Leakage Current

Patient leakage currents are measured between a selected applied part and mains earth. All measurements have a true RMS only.

The following outlet conditions apply when performing the Patient Leakage Current test.

- normal polarity( Normal Condition);
- reverse polarity( Normal Condition);
- normal polarity with open neutral(Single Fault Condition);
- reverse polarity with open neutral(Single Fault Condition);
- normal polarity with open earth(Single Fault Condition);
- reverse polarity with open earth(Single Fault Condition).

■ LIMITS

For BF  applied parts,

- 100µA in Normal Condition.
- 500µA in Single Fault Condition.

## E.8 Mains on Applied Part Leakage

The Mains on Applied Part test applies a test voltage, which is 110% of the mains voltage, through a limiting resistance, to selected applied part terminals. Current measurements are then taken between the selected applied part and earth. Measurements are taken with the test voltage (110% of mains) to applied parts in the normal and reverse polarity conditions.

The following outlet conditions apply when performing the Mains on Applied Part test.

- Normal Polarity;
- Reversed Polarity.

■ LIMITS

- For BF  applied parts: 5000 µA.

## E.9 Patient Auxiliary Current

Patient Auxiliary currents are measured between any selected Applied Part connector and the remaining Applied Part connectors. All measurements may have a true RMS only response.

The following outlet conditions apply when performing the Patient Auxiliary Current test.

- normal polarity( Normal Condition);
- reverse polarity( Normal Condition);
- normal polarity with open neutral(Single Fault Condition);
- reverse polarity with open neutral(Single Fault Condition);
- normal polarity with open earth(Single Fault Condition);
- reverse polarity with open earth(Single Fault Condition).

■ LIMITS

For BF  applied parts,

- 100µA in Normal Condition.
- 500µA in Single Fault Condition.

**Note:** Make sure the safety analyzer is authorized comply with requirement of IEC61010-1.  
Follow the instructions of the analyzer manufacturer.





