

BeneVision

TMS60 Telemetry Monitoring System/ TM80 Telemetry Monitor

Operator's Manual

© Copyright 2017 -2019 Shenzhen Mindray Bio-Medical Electronics Co., Ltd. All rights reserved.

- Release time: January 2019
- Revision: 5.0

WARNING

- **Federal Law (USA) restricts this device to sale by or on the order of a physician or other practitioner licensed by U.S. state law to use or order the use of this device.**
-
-

Intellectual Property Statement

SHENZHEN MINDRAY BIO-MEDICAL ELECTRONICS CO., LTD. (hereinafter called Mindray) owns the intellectual property rights to this Mindray product and this manual. This manual may refer to information protected by copyrights or patents and does not convey any license under the patent rights of Mindray, nor the rights of others.

Mindray intends to maintain the contents of this manual as confidential information. Disclosure of the information in this manual in any manner whatsoever without the written permission of Mindray is strictly forbidden.

Release, amendment, reproduction, distribution, rental, adaption and translation of this manual in any manner whatsoever without the written permission of Mindray is strictly forbidden.

 **mindray**, **MINDRAY**, and **MINDRAY** are the registered trademarks or trademarks owned by Mindray in China and other countries. All other trademarks that appear in this manual are used only for editorial purposes without the intention of improperly using them. They are the property of their respective owners.

This posting serves as notice under 35 U.S.C.\$287(a) for Mindray patents:
<http://www.mindrayna.com/patents>.

Manufacturer's Responsibility

Contents of this manual are subject to changes without prior notice.

All information contained in this manual is believed to be correct. Mindray shall not be liable for errors contained herein nor for incidental or consequential damages in connection with the furnishing, performance, or use of this manual.

Mindray is responsible for the effects on safety, reliability and performance of this product, only if:

- All installation operations, expansions, changes, modifications and repairs of this product are conducted by Mindray authorized personnel;
- The electrical installation of the relevant room complies with the applicable national and local requirements;
- The product is used in accordance with the instructions for use.

WARNING

- **Only skilled/trained clinical professionals should operate this equipment.**
 - **It is important for the hospital or organization that employs this equipment to carry out a reasonable service/maintenance plan. Neglect of this may result in machine breakdown or personal injury.**
-
-

Company Contact

Manufacturer: Shenzhen Mindray Bio-Medical Electronics Co., Ltd.
Address: Mindray Building, Keji 12th Road South, High-tech Industrial park, Nanshan, Shenzhen 518057, P.R.China
Website: www.mindray.com
E-mail Address: service@mindray.com
Tel: +86 755 81888998
Fax: +86 755 26582680

Distributor: Mindray DS USA, Inc.
Address: 800 MacArthur Boulevard, Mahwah, New Jersey 07430 USA
Tel: 1.800.288.2121, 1.201.995.8000
Website: www.mindray.com

EC-Representative: Shanghai International Holding Corp. GmbH (Europe)
Address: Eiffestraße 80, 20537 Hamburg, Germany
Tel: 0049-40-2513175
Fax: 0049-40-255726

Preface

Manual Purpose

This manual contains the instructions necessary to operate the product safely and in accordance with its function and intended use. Observance of this manual is a prerequisite for proper product performance and correct operation and ensures patient and operator safety.

This manual is based on the maximum configuration and therefore some contents may not apply to your product. If you have any questions, please contact Mindray.

This manual is an integral part of the product. It should always be kept close to the equipment so that it can be obtained conveniently when needed.

Intended Audience

This manual is geared for clinical professionals who are expected to have a working knowledge of medical procedures, practices and terminology as required for monitoring of critically ill patients.

Illustrations

All illustrations in this manual serve as examples only. They may not necessarily reflect the setup or data displayed on your equipment.

Conventions

- *Italic text* is used in this manual to quote the referenced chapters or sections.
- **Bold text** is used to indicate the screen texts and names of hard keys.
- → is used to indicate operational procedures.

Contents

1 Safety	1 - 1
1.1 Safety Information	1 - 2
1.1.1 Warnings	1 - 3
1.1.2 Cautions	1 - 5
1.1.3 Notes	1 - 6
1.2 Equipment Symbols	1 - 7
2 General Product Description	2 - 1
2.1 Intended Use	2 - 2
2.2 Applied Parts	2 - 3
2.3 Key Features	2 - 3
2.4 System Components	2 - 3
2.4.1 System Components for the TMS60	2 - 3
2.4.2 System Components for the TM80	2 - 5
2.5 Physical View	2 - 5
2.6 Touch Screen Display	2 - 7
2.6.1 Display Screen	2 - 7
2.6.2 On-Screen Keyboard	2 - 9
3 Getting Started	3 - 1
3.1 Unpacking and Checking	3 - 3
3.2 Environmental Requirements	3 - 4
3.3 Connecting the ECG Leadwire	3 - 5
3.4 Installing the Batteries	3 - 6
3.4.1 Installing the Lithium-ion Rechargeable Battery Pack	3 - 7
3.4.2 Installing the AA Batteries	3 - 8
3.5 Powering On the Unit	3 - 9
3.6 Understanding Touch Gestures	3 - 10
3.7 Basic Operations	3 - 10
3.7.1 Understanding the Screen Display Orientation	3 - 11
3.7.2 Browsing the Screen Display	3 - 11
3.7.3 Switching the Screen Display Orientation	3 - 11
3.7.4 Flipping the Landscape Display	3 - 12
3.7.5 Displaying the Quick Keys Area	3 - 12
3.7.6 Entering the Main Menu	3 - 13
3.7.7 Turning the Display Off	3 - 14
3.7.8 Turning the Display On	3 - 14
3.7.9 Unlocking the Screen in Locked Mode	3 - 14
3.7.10 Unlocking the Screen in View Only Mode	3 - 15
3.7.11 Acknowledging the Nurse Call	3 - 15
3.8 Using the Pouch	3 - 15

3.8.1 Securing the Pouch for the TD60/TM80	3 - 16
3.8.2 Securing Pouches for the TD60/TM80 and BP10	3 - 18
4 User Configurations	4 - 1
4.1 Introduction	4 - 2
4.2 Configuring the Display	4 - 2
4.2.1 Setting the Default Display Orientation	4 - 2
4.2.2 Understanding Portrait Orientation Display Rules	4 - 2
4.2.3 Setting the Portrait Display	4 - 2
4.2.4 Understanding Landscape Orientation Display Rules	4 - 3
4.2.5 Setting the Landscape Display	4 - 3
4.2.6 Setting the Display Brightness	4 - 4
4.3 Configuring the Audio Volume	4 - 4
5 Patient Management	5 - 1
5.1 Introduction	5 - 2
5.2 Admitting a Patient	5 - 2
5.2.1 Admitting a Patient at the TD60	5 - 2
5.2.2 Admitting a Patient at the TM80	5 - 2
5.3 Changing the Patient Category	5 - 2
5.4 Placing a Device in Standby	5 - 3
5.5 Exiting the Standby Mode	5 - 4
5.6 Discharging the Patient	5 - 4
5.6.1 Selecting the Discharge Patient menu	5 - 4
5.6.2 Restarting the TD60/TM80	5 - 5
6 Alarms	6 - 1
6.1 Introduction	6 - 2
6.2 Alarm Categories	6 - 2
6.3 Alarm Levels	6 - 2
6.4 Alarm Indicators	6 - 3
6.4.1 Alarm Light	6 - 3
6.4.2 Alarm Tones	6 - 3
6.4.3 Alarm Messages	6 - 4
6.4.4 Alarm Status Symbols	6 - 4
6.5 Configuring Alarms	6 - 5
6.6 Resetting Alarms	6 - 5
7 Monitoring ECG	7 - 1
7.1 Introduction	7 - 2
7.2 Safety	7 - 2
7.3 Preparation for Monitoring ECG	7 - 3
7.3.1 Preparing the Patient's Skin	7 - 3
7.3.2 Positioning the Electrodes	7 - 3
7.3.3 Setting ECG Lead Labeling	7 - 5

7.3.4 Placing the Electrodes	7 - 5
7.3.5 Checking the Lead Placement	7 - 11
7.3.6 Setting the Paced Status	7 - 12
7.3.7 Maintaining Quality ECG Signal	7 - 13
7.4 Changing the ECG Settings	7 - 14
7.4.1 Configuring the ECG Setup	7 - 14
7.4.2 ECG Leadwire Types	7 - 15
7.4.3 Configuring the ECG Waveforms	7 - 15
7.4.4 Configuring the Pacer	7 - 16
7.4.5 Configuring the ECG Waveform Size	7 - 16
7.4.6 Setting the Notch Filter	7 - 17
7.5 Understanding the ECG Display	7 - 17
7.5.1 HR Digital Area	7 - 17
7.5.2 About the HR Digital Area	7 - 17
7.5.3 ECG Waveform Area	7 - 18
7.5.4 About the ECG Waveform Area	7 - 18

8 Monitoring Respiration (Resp) (Optional) 8 - 1

8.1 Introduction	8 - 2
8.2 Safety	8 - 2
8.3 Preparation for Monitoring Resp	8 - 3
8.3.1 Preparing the Patient's Skin	8 - 3
8.3.2 Positioning the Electrodes	8 - 3
8.4 Changing the Resp Settings	8 - 4
8.4.1 Configuring the Resp Setup	8 - 4
8.4.2 Configuring the Resp Waveform	8 - 5
8.5 Understanding the Resp Display	8 - 6
8.5.1 Resp Digital Area	8 - 6
8.5.2 About the Resp Digital Area	8 - 6
8.5.3 Resp Waveform Area	8 - 6
8.5.4 About the Resp Waveform Area	8 - 7

9 Monitoring SpO2 (Optional) 9 - 1

9.1 Introduction	9 - 2
9.2 Measurement Limitations	9 - 3
9.3 Safety	9 - 3
9.4 Connecting the SpO2 Module	9 - 5
9.5 Changing the SpO2 Settings	9 - 7
9.5.1 Configuring the SpO2 Setup	9 - 7
9.5.2 Configuring the SpO2 Waveform	9 - 9
9.6 SpO2 Measurement	9 - 9
9.6.1 Identifying SpO2 Modules	9 - 9
9.6.2 Applying the Sensor	9 - 10
9.7 Understanding the SpO2 Display	9 - 11
9.7.1 SpO2 Digital Area	9 - 11

9.7.2 About the SpO2 Digital Area	9 - 12
9.7.3 SpO2 Waveform Area	9 - 12
9.7.4 About the SpO2 Waveform Area	9 - 12
9.8 Masimo Information	9 - 13
10 Monitoring NIBP (Optional)	10 - 1
10.1 Introduction	10 - 2
10.2 Pairing the TD60/TM80 with the BP10	10 - 2
10.2.1 Pairing Procedure	10 - 2
10.2.2 System Responses after Successfully Pairing	10 - 3
10.3 Unpairing the TD60/TM80 with the BP10	10 - 4
10.3.1 Unpairing via the TD60/TM80	10 - 4
10.3.2 Unpairing via BP10	10 - 5
10.3.3 System Responses after Successfully Unpairing	10 - 5
10.4 Screen Display after Pairing a TD60/TM80 with a BP10	10 - 6
10.5 Interactions after Pairing a TD60/TM80 with a BP10	10 - 7
10.5.1 Overview of Interactions	10 - 7
10.5.2 Operating the BP10 via the TD60/TM80	10 - 8
10.5.3 NIBP Operations at the TD60/TM80	10 - 8
11 Configuring the TD60/TM80	11 - 1
11.1 Introduction	11 - 2
11.2 Entering the Maintenance menu	11 - 2
11.3 Configuring the General Menu	11 - 2
11.4 Configuring the Alarms Menu	11 - 3
11.5 Quick Keys Menu	11 - 5
11.5.1 Changing the Quick Keys	11 - 5
11.5.2 Deleting a Quick Key	11 - 6
11.6 Configuring the Network Menu (for TM80 only)	11 - 6
11.6.1 Configuring IP Settings	11 - 7
11.6.2 Configuring WLAN Settings	11 - 8
11.6.3 Configuring Central Monitoring System Connection	11 - 9
11.6.4 Selecting a Central Monitoring System	11 - 10
11.6.5 Selecting WiFi Bands and Channels	11 - 10
11.6.6 EAP Certificate Management	11 - 11
11.7 Configuring the Defaults Menu	11 - 13
11.7.1 Transferring a Configuration	11 - 13
11.8 Screen Lock Menu	11 - 14
11.8.1 Understanding the Screen Lock Mode	11 - 14
11.8.2 Setting the Screen Lock	11 - 15
11.8.3 Changing the Current Screen Lock Passcode	11 - 15
11.8.4 Changing the Screen Lock Mode	11 - 15
11.9 Changing the Passwords	11 - 15
11.10 Changing the Device Name	11 - 16
11.11 Setting CMS Disconnect Alarm (For the TM80 Only)	11 - 16

11.12 Demo Mode	11 - 17
11.13 Service Menu	11 - 17
12 Monitoring with the TMS60/TM80 at the CMS	12 - 1
12.1 Introduction	12 - 2
12.2 Monitoring at the CMS (Version Earlier than 03.00)	12 - 2
12.2.1 Physiological Alarms	12 - 2
12.2.2 ECG Monitoring	12 - 11
12.2.3 QT Monitoring	12 - 17
12.2.4 ST Monitoring	12 - 21
12.2.5 Arrhythmia Monitoring	12 - 25
12.2.6 SpO2 Monitoring	12 - 31
12.2.7 Measurement Limitations	12 - 31
12.2.8 SpO2 Settings	12 - 31
12.2.9 SpO2 Display	12 - 32
12.3 Monitoring at the CMS (Version 03.00 or Above)	12 - 34
12.3.1 Physiological Alarms	12 - 34
12.3.2 ECG Monitoring	12 - 41
12.3.3 QT Monitoring	12 - 45
12.3.4 ST Monitoring	12 - 48
12.3.5 Arrhythmia Monitoring	12 - 52
12.3.6 Resp Monitoring	12 - 54
12.3.7 SpO2 Monitoring	12 - 57
12.3.8 NIBP Monitoring	12 - 59
12.3.9 Locating the TM80	12 - 61
13 Battery	13 - 1
13.1 Introduction	13 - 2
13.2 Safety	13 - 2
13.3 Installing the Battery	13 - 4
13.4 Checking the Battery Charge Status	13 - 4
13.5 Removing the Battery	13 - 4
13.6 Charging the Rechargeable Lithium-ion Battery	13 - 5
13.7 Storing the Batteries	13 - 6
13.7.1 Storing Rechargeable Lithium-ion Battery	13 - 6
13.7.2 Storing AA Batteries	13 - 7
13.8 Maintaining the Rechargeable Lithium-ion Battery	13 - 7
13.9 Disposing of the Batteries	13 - 8
13.9.1 Disposing of the Rechargeable Lithium-ion Battery	13 - 8
13.9.2 Disposing of the AA Batteries	13 - 8
14 Troubleshooting	14 - 1
14.1 General Problems	14 - 2
14.2 Physiological Alarm Messages at the CMS	14 - 4
14.3 Technical Alarm Messages at the TD60/TM80	14 - 7

15 Cleaning and Disinfecting	15 - 1
15.1 Introduction	15 - 2
15.2 Safety Information	15 - 2
15.3 Cleaning and Disinfecting the Equipment	15 - 3
15.3.1 Approved Cleaning and Disinfecting Agents	15 - 3
15.3.2 Cleaning the Equipment	15 - 5
15.3.3 Disinfecting the Equipment	15 - 7
15.4 Cleaning and Disinfecting ECG Leadwires and SpO2 Sensors	15 - 7
15.5 Cleaning and Disinfecting Other Parts	15 - 8
15.6 Sterilization	15 - 9
15.7 Impact of Improper Cleaning or Disinfection	15 - 9
16 Maintenance	16 - 1
16.1 Introduction	16 - 2
16.2 Safety	16 - 2
16.3 Regular Check	16 - 3
16.4 Maintenance and Testing Schedule	16 - 4
16.5 Power-on Test	16 - 5
16.6 Verifying the ECG at the TD60/TM80	16 - 5
16.7 NIBP Accuracy Test	16 - 5
16.8 NIBP Leakage Test	16 - 5
16.9 Nurse Call Test	16 - 5
16.10 Electrical Safety Tests	16 - 6
16.11 Battery Check	16 - 6
16.12 Viewing System Information	16 - 6
17 Accessories	17 - 1
17.1 ECG Accessories	17 - 2
17.1.1 ECG Electrodes	17 - 2
17.1.2 ECG Leadsets	17 - 3
17.2 SpO2 Accessories	17 - 4
17.2.1 Masimo SpO2 Module	17 - 4
17.2.2 Masimo SpO2 Sensor	17 - 4
17.2.3 Nonin SpO2 Module	17 - 5
17.2.4 Nonin SpO2 Sensor	17 - 5
17.3 NIBP Accessories	17 - 5
17.4 Miscellaneous	17 - 5
A Product Specifications	A - 1
A.1 Classifications	A - 2
A.2 Environmental Specifications	A - 3
A.3 Power Supply Specifications	A - 3
A.3.1 TD60/TM80	A - 3

A.3.2 RC60	A - 4
A.3.3 Central Charger	A - 4
A.4 Physical Specifications	A - 5
A.5 Hardware Specifications	A - 5
A.5.1 TD60/TM80	A - 5
A.5.2 RC60	A - 6
A.5.3 Central Charger	A - 7
A.6 Wireless Specification	A - 7
A.6.1 WMTS Specification for the TD60	A - 7
A.6.2 Mindray Patient Area Network (MPAN) Specification (For the TD60/TM80)	A - 9
A.6.3 Wi-Fi Specifications (For the TM80 Only)	A - 10
A.7 Measurement Specifications	A - 12
A.7.1 ECG	A - 12
A.7.2 Resp	A - 16
A.7.3 SpO2	A - 17
B EMC	B - 1
C FCC Compliance	C - 1
D Symbols and Abbreviations	D - 1
D.1 Units	D - 2
D.2 Symbols	D - 3
D.3 Abbreviations	D - 3

This page intentionally left blank.

1

Safety

Safety Information	1-2
Equipment Symbols.....	1-7

1.1 Safety Information

WARNING

- **Indicates a potential hazard or unsafe practice that, if not avoided, could result in death or serious injury.**
-
-

CAUTION

- **Indicates a potential hazard or unsafe practice that, if not avoided, could result in minor personal injury or product/property damage.**
-

NOTE

- **Provides application tips or other useful information to ensure that you get the most from your product.**
-

1.1.1 Warnings

WARNING

- **The TD60/TM80 is intended to be used for a single patient at a time.**
 - **The TMS60/TM80 must be operated by medical personnel in hospitals.**
 - **For continued safe use of the TMS60/TM80, the instructions given in this manual must be followed. But instructions in this manual in no way supersede established medical procedures.**
 - **To avoid explosion hazard, do not use the TMS60/TM80 in the presence of oxygen-rich atmospheres, flammable anesthetics, or other flammable agents.**
 - **Do not use the TMS60/TM80 in conjunction with Electro Surgical Unit (ESU).**
 - **Do not expose the TMS60/TM80 to a Magnetic Resonance (MR) environment.**
 - ◆ **Thermal injury and burns may occur due to the metal components of the equipment which can heat during MR scanning.**
 - ◆ **The equipment may present a risk of projectile injury due to the presence of ferromagnetic materials which can be attracted by the MR magnet core.**
 - ◆ **The leadwires and electrodes will generate artifacts in the MR image.**
 - ◆ **The equipment will not function properly due to the strong magnetic and radio frequency fields generated by the MR scanner.**
 - **Before putting the system into operation, the operator must verify that the TMS60/TM80, connecting cables and accessories are in correct working order and operating condition.**
 - **Do not use patient cables or accessory cables and sensors if prior visual inspection reveals cable damage or the presence of liquid, lint or dust inside.**
 - **Do not come into contact with the patient during defibrillation. Otherwise serious injury or death could result.**
 - **Do not touch the patient and live parts simultaneously.**
-

WARNING

- **Do not open the equipment housings. All servicing and future upgrades must be carried out by trained and authorized personnel.**
 - **Do not rely exclusively on the audible alarm system for monitoring. Adjustment of alarm volume to a low level may result in a hazard to the patient. Always keep the patient under close surveillance.**
 - **The physiological data and alarm messages displayed on the system are for reference only and cannot be directly used for diagnostic interpretation.**
 - **PATIENTS WITH A PACEMAKER – On ventricular paced patients, episodes of ventricular tachycardia may not always be detected. Do not rely entirely upon the system's automated arrhythmia detection algorithm. Keep pacemaker patients under close surveillance.**
 - **Do not operate the touch screen with wet hands.**
 - **Only use parts and accessories specified in this manual.**
 - **Route, wrap and secure the cables to avoid inadvertent disconnection, stumbling and entanglement.**
 - **To avoid risk of electric shock, RC60 and central charger must only be connected to a supply mains with protective earth.**
 - **Instruct patients not to interact with the display of the TD60/TM80 and not to open the battery compartment while the TD60/TM80 is in use.**
 - **Auditory alarm signal sound pressure levels that are less than ambient levels can impede operator recognition of alarm conditions.**
-
-

1.1.2 Cautions

CAUTION

- **Do not let the display of the TD60/TM80 directly touch the patient when the display is on.**
 - **When the Central Monitoring System presents the alarm “RF No Signal” for the TMS60 or “Offline” for TM80, the settings being performed on the TD60/TM80 may not be transferred to the central monitoring system. Check the patient condition and the settings on the Central Monitoring System.**
 - **When disposing of the packaging material, be sure to observe the applicable waste control regulations and keep it out of children’s reach.**
 - **After the configurations, such as the patient category, paced status, are changed at the TD60/TM80, the medical personnel should check those configurations at the Central Monitoring System to make sure both of the configurations are consistent.**
 - **The patient should remain in the specified coverage area. If the patient is at the edge of or outside the coverage area, an unstable network connection may compromise the monitoring performance. The patient’s location is of vital importance for the TM80. If a life-threatening situation occurs for a patient, this patient must be located and found by medical staff immediately.**
 - **Mindray takes no responsibility for controlling the radio frequency environment in a hospital. If interference for the operating frequency of telemetry equipment exists, the telemetry equipment performance will be affected. Exercise caution when selecting the operating frequency of all the wireless equipment in a hospital as this is very important to avoid mutual interference among them.**
 - **Magnetic and electrical fields are capable of interfering with the proper performance of the equipment. For this reason make sure that all external equipment operated in the vicinity of the equipment comply with the relevant EMC requirements. Mobile phone, X-ray equipment or MRI equipment are a possible source of interference as they may emit higher levels of electromagnetic radiation.**
 - **Always install or carry the TD60/TM80 properly to avoid damage caused by drop, impact, strong vibration or other mechanical force.**
-

CAUTION





















- **Dry the TD60/TM80 immediately in case of rain or water spray.**
 - **The TMS60/TM80 generates and uses the Radio Frequency (RF) energy. If it is not installed correctly or not used as per the manual, RF interference to other equipment could result.**
 - **When the patient carrying a TD60/TM80 moves in a hospital, signal quality can be impacted on an ambulatory patient by the construction materials used within the hospital..**
 - **At the end of its service life, the equipment and its accessories must be disposed of in compliance with the guidelines regulating the disposal of such products. If you have any questions concerning disposal of the equipment, please contact Mindray.**
 - **When programming the frequency for a transmitter, the frequencies allocated to all other transmitters need to be considered to ensure that no two transmitters are programmed with the same frequency.**
-

1.1.3 Notes

NOTE

- **Put the equipment in a location where you can easily view and operate the equipment.**
 - **In normal use, the operator shall stand in front of the equipment.**
 - **The software was developed in compliance with IEC60601-1-4. The possibility of hazards arising from software errors is minimized.**
 - **This manual describes all features and options. Your equipment may not have all of them.**
 - **Keep this manual in the vicinity of the equipment so that it can be obtained conveniently when needed.**
-

1.2 Equipment Symbols

Symbol	Description	Symbol	Description
	Power On/Off key		Main menu key
	Nurse call key		Symbol for aligning the SpO ₂ connector
	Charge indicator		Alternating current
	DEFIBRILLATION-PROOF TYPE CF APPLIED PART		Serial number
	Date of Manufacture		Manufacturer
	MR Unsafe – do not subject to magnetic resonance imaging (MRI)		Protection against fluid ingress
	Non-ionizing radiation		General warning sign
	Refer to instruction manual/booklet		Stand-by
	Humidity limitation		Atmospheric pressure limitation
	Temperature limitation		Plastics identification symbol
<p>ETL CLASSIFIED</p>  <p>Intertek 3179617</p>	<p>The presence of this label indicates the machine was certified by ETL with the statement:</p> <p>Conforms to AAMI Std ES 60601-1, IEC Std 60601-1-6, IEC Std 60601-1-8, IEC Std 60601-2-27, IEC Std 60601-2-49, ISO Std 80601-2-61, IEC Std. 80601-2-30</p> <p>Certified to CSA Std C22.2 NO. 60601-1, NO. 60601-1-6, NO. 60601-1-8, NO.60601-2-27, NO. 60601-2-49, NO.80601-2-61, NO.80601-2-30</p>		

NOTE

- **Some symbols may not appear on your equipment.**
-

2

General Product Description

Intended Use	2-2
Applied Parts	2-3
Key Features	2-3
System Components	2-3
Physical View	2-5
Touch Screen Display.....	2-7

2.1 Intended Use

The telemetry monitoring systems are designed to acquire and monitor physiological data for ambulating patients within a defined coverage area.

The TMS60 transmitter is intended for use on Adult and Pediatric patients over three years old to monitor ECG, SpO₂, NIBP and Resp physiological data. The physiological data can be reviewed locally on the display of the transmitter. The CentralStation will support ECG, Heart Rate, SpO₂, NIBP, Resp, Pulse Rate, Arrhythmia analysis, QT monitoring, and ST Segment Analysis for the TMS60.

The TM80 telemetry monitor is intended for use on Adult and Pediatric patients over three years old to monitor ECG, SpO₂, NIBP and Resp physiological data. The physiological data can be reviewed locally on the display of the monitor. The CentralStation will support ECG, Heart Rate, SpO₂, NIBP, Resp, Pulse Rate, Arrhythmia analysis, QT monitoring, and ST Segment Analysis for the TM80.

The telemetry monitoring systems are intended for use in professional healthcare facilities under the direct supervision of a licensed healthcare practitioner.

WARNING

- **Only skilled/trained clinical professionals should operate the TMS60/TM80.**
 - **The TMS60/TM80 is not designed for monitoring critically ill patients.**
 - **If the accuracy of any value displayed at the Central Monitoring System or the TD60/TM80 is questionable, determine the patient's vital signs by alternative means and verify that the telemetry device is working correctly.**
 - **The TMS60/TM80 transmits the data through the wireless connection. There might be a risk of data loss.**
-
-

2.2 Applied Parts

The TMS60/TM80 has the following applied parts:

- ECG leadwires
- SpO₂ cables
- SpO₂ sensors
- NIBP tubes and cuffs

2.3 Key Features

- 3.5" color PTC touch screen display is easy for clinicians to use.
- Small, portable, and lightweight for patients to wear.
- The TMS60 supports 3/5 lead ECG and the TM80 supports 3/5/6-lead ECG.
- Support Masimo and Nonin SpO₂ modules.
- Communication to the Central Monitoring System (hereinafter abbreviated as CMS) utilizes the protected WMTS 608-614 band for the TMS60 and utilizes Dual Band 802.11b/g/n for the TM80.
- Display the battery status and supports the multiple levels of battery alarms.
- Display Heart Rate (HR) , Resp, SpO₂, NIBP parameter numerics and ECG, SpO₂, and Resp waveforms.
- Battery options of two AA, three AA, or lithium-ion battery pack are available.
- Display supports parameter auto-sizing.

2.4 System Components

2.4.1 System Components for the TMS60

The telemetry monitoring system (TMS60) includes the following components:

- Telemetry transmitter (TD60)
- Telemetry antenna array
- Telemetry receiver (RC60)
- NIBP module (BP10)
- Central charger
- Accessories

NOTE

- For information about the BP10 and the central charger, refer to ***BP10 NIBP Module Operator's Manual (P/N 046-011008-00)*** and ***BeneVison Central Charger Operator's Manual (P/N 046-007059-00)*** respectively.
-

2.4.1.1 TD60 Telemetry Transmitter

For information about the TD60 telemetry transmitter, refer to ***"Physical View" on page 2 - 5.***

2.4.1.2 Antenna Array

The antenna array must be installed and configured by Mindray authorized personnel. For more details about the antenna array, refer to ***Telemetry Monitoring System Installation Guide (P/N 046-007624-00).***

WARNING

- **Authorized Mindray personnel are required to confirm the coverage area of the antenna array in the following situations:**
 - ◆ **When the antenna array is initially installed.**
 - ◆ **When the antenna array is modified.**
 - ◆ **When the building construction is modified.**
-
-

2.4.1.3 Telemetry Receiver (RC60)

The RC60 receives the data from the TD60 via the antenna array, and sends the data to the CMS to analyze and display.

For details about the general wireless communication problems, refer to ***"General Problems" on page 14 - 2'.***

For details about the frequency allocation and receiver connection, refer to ***Telemetry Monitoring System Installation Guide (P/N 046-007624-00).***

For details about the RC60, refer to ***TMS60 Service Manual (P/N 046-007057-00).***

2.4.2 System Components for the TM80

The TM80 Telemetry Monitor includes the following components:

- TM80 Telemetry Monitor main unit
- NIBP module (BP10)
- Central charger
- Accessories

NOTE

- **This manual only describes the TM80 Telemetry Monitor main unit (hereinafter called the TM80). For information about the BP10 and the central charger, refer to *BP10 NIBP Module Operator's Manual (P/N 046-011008-00)* and *BeneVison Central Charger Operator's Manual (P/N 046-007059-00)* respectively.**

2.5 Physical View

The TD60 and TM80 have a similar physical view.

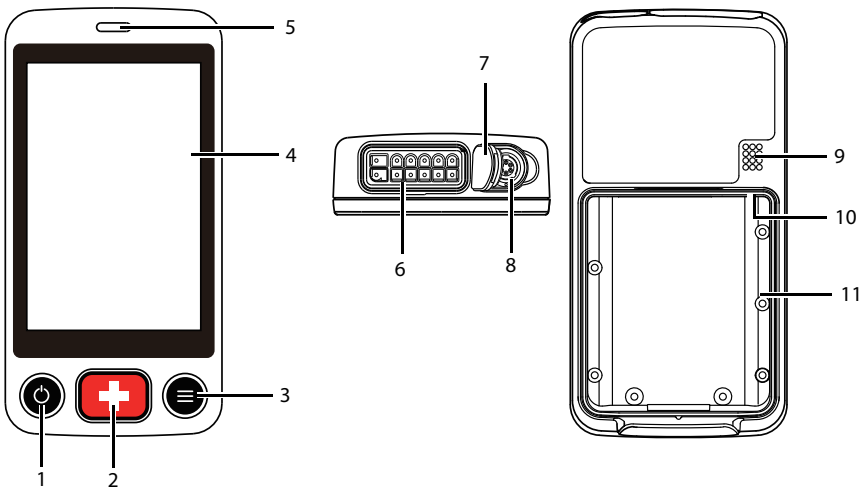

1. Activation (Power On/Off) key
 - When the device is powered off
 - ◆ Pressing this key will turn the device on.
 - When the device is powered on
 - ◆ And the screen display is on, pressing this key will turn the display off.
 - ◆ And the screen display is off, pressing this key will turn the display on.
 - ◆ Press and hold this key for two seconds to display the power off confirmation menu.
2. Nurse Call key
 - Pressing this key will send a nurse call request to the CMS. The alarm light/indicator will illuminate cyan, and a "Nurse Call Initiated" message will display in the message area if the display is on.
3. Main Menu key
 - ◆ Pressing this key when on the main screen will open the main menu.
 - ◆ Pressing this key when a menu is open will return to the main screen.
 - ◆ Pressing this key when the display is off will turn the display on.
 - ◆ Pressing this key when the screen lock mode is configured for View Only will display the **Screen Locked** menu.
4. Display
 - The touch screen is the primary user interface for operating the device and viewing information (or patient data).
5. Alarm light/indicator
 - Flashes in different colors and at different frequencies corresponding to the alarm level.
6. ECG connector
 - Connects the ECG leadset.
7. SpO₂ cap
 - Covers SpO₂ connector when SpO₂ is not in use.
8. SpO₂ connector
 - Connects the SpO₂ module.
9. Speaker
10. USB connector
 - It is only available for authorized service personnel.
11. Battery compartment
 - Contains the lithium-ion battery pack or AA battery tray.

2.6 Touch Screen Display

WARNING



- **Do not operate the touch screen with wet hands.**

Move your finger on the touch screen display to operate the TD60/TM80. For details about the supported touch gestures, refer to **"Understanding the Screen Display Orientation" on page 3 - 11.**



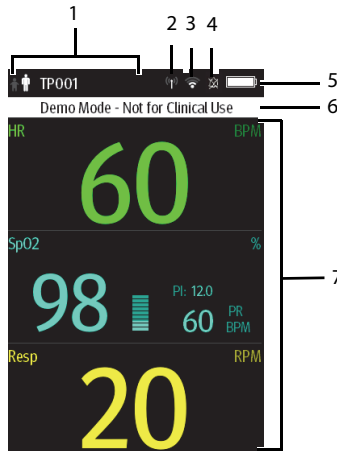

2.6.1 Display Screen

The main screen displays patient parameters and waveforms. A typical display screen is shown below.





1. Patient information area
This area shows the patient information such as patient size, device name, and department. Tapping this area displays the **Patient Info** menu.
2. Mindray Patient Area Network (MPAN) indicator
 - ◆  indicates that the TD60/TM80 is not paired with a BP10 or one TD60/TM80 is not connected to another TD60/TM80 for configuration transfer.
 - ◆  indicates that the TD60/TM80 is paired with the BP10 successfully or configuration transfer of the TD60/TM80 is in progress.

3. Wi-Fi symbol: This symbol is for the TM80 only.

- ◆  indicates that the TM80 has been connected to the Wi-Fi access point and the signal coverage is very good. Stable data transmission via Wi-Fi network can be guaranteed.
- ◆  indicates that the TM80 has been connected to the Wi-Fi access point and the signal coverage is good. Stable data transmission via Wi-Fi network can be guaranteed.
- ◆  indicates that the TM80 has been connected to the Wi-Fi access point and the signal coverage can meet the requirements. Stable data transmission via Wi-Fi network can be guaranteed.
- ◆  indicates that the TM80 has been connected to the Wi-Fi access point and the signal coverage is weak. Wi-Fi offline may occur.
- ◆  indicates that the TM80 is not connected to the Wi-Fi access point.

4. Alarm symbols

- ◆  indicates that the alarm system is reset.
- ◆  indicates that the technical alarm audio is turned off.

5. Battery symbol

This symbol indicates the battery charge status. For details about the battery status symbols, refer to "**Checking the Battery Charge Status**" on page 13 - 4. Tapping the battery symbol opens the **System Info** menu to the battery section.

6. Prompt message area

This area shows technical alarm messages and informational messages, where there are multiple messages, the messages scroll.

7. Patient data area

This user configurable area can display parameter/waveform data. The parameter/waveform is labeled in the upper left corner. You may also tap this area to display the Setup menu for the corresponding parameter/waveform.

For details about the touch screen operations, refer to "**Basic Operations**" on page 3 - 10.

2.6.2 On-Screen Keyboard

The TD60/TM80 uses an on-screen keyboard to enter alphanumeric information, such as the device name and passwords.

2.6.2.1 Alphabetic Keyboard



1. Alphabetic buttons: tap to input the desired alphabetic text.
2. Delete button: tap to erase the text to the left of the cursor.
3. Accept button: tap to save the settings and exit the keyboard.
4. Space button: tap to input a space.
5. Numeric switch button: tap to switch to the numeric layout.
6. Case shift button: tap to switch the case of the letter.
This switch is active for one character entry.

2.6.2.2 Numeric Keyboard

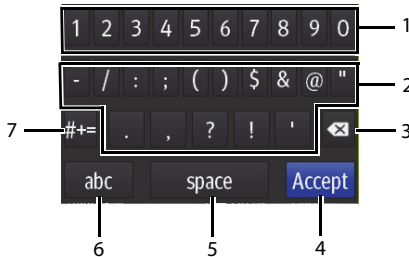

1. Numeric buttons: tap to input the desired numbers.
2. Punctuation buttons: tap to input the desired punctuation mark or symbol.
3. Delete button: tap to erase the text to the left of the cursor.
4. Accept button: tap to save the settings and exit the keyboard.

5. Space button: tap to input a space.
6. Alphabetic switch button: tap to switch to the alphabetic layout.
7. More punctuation buttons: tap to display the punctuation keyboard, as shown below:

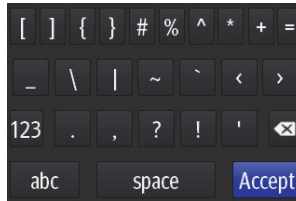

3

Getting Started

Unpacking and Checking.....	3-3
Environmental Requirements	3-4
Connecting the ECG Leadwire	3-5
Installing the Batteries	3-6
Powering On the Unit.....	3-9
Understanding Touch Gestures	3-10
Basic Operations.....	3-10
Using the Pouch	3-15

WARNING

- **The TMS60/TM80 shall be installed by Mindray authorized personnel.**
 - **The software equipment copyright is solely owned by Mindray. No organization or individual shall resort to altering, copying, or exchanging it or to any other infringement on it in any form or by any means without due permission.**
 - **Connect only approved devices to this system. Devices connected to the equipment must meet the requirements of the applicable IEC standards (e.g. IEC 60950 safety standards for information technology equipment and IEC 60601-1 safety standards for medical electrical equipment). The system configuration must meet the requirements of the IEC 60601-1 medical electrical systems standard. Any personnel who connect devices to the equipment's signal input/output port is responsible for providing evidence that the safety certification of the devices has been performed in accordance to the IEC 60601-1. If you have any questions, please contact Mindray.**
 - **If it is not evident from the equipment specifications whether a particular combination with other devices is hazardous, for example, due to summation of leakage currents, please consult the manufacturers or else an expert in the field, to ensure the necessary safety of patients and all devices concerned will not be impaired by the proposed combination.**
 - **Contact Mindray to relocate the TMS60/TM80.**
 - **Only Mindray authorized personnel can update the TMS60/TM80.**
-
-

CAUTION

- **Many settings in the TMS60/TM80 are password protected. It is recommended to change the default passwords and keep the passwords safe. Passwords should only be changed by authorized personnel. Contact your department manager or biomedical engineering department for the passwords used at your facility.**
-

3.1 Unpacking and Checking

Before unpacking, examine the packing case carefully for signs of damage. If any damage is detected, contact the carrier or Mindray.

If the packing case is intact, open the package and remove the device and accessories carefully. Check all materials against the packing list and check for any mechanical damage. Contact Mindray in case of any problem.

WARNING

- **Before use, please verify whether the packages are intact, especially the packages of single use accessories. In case of any damage, do not apply it to patients.**
 - **The TMS60 generates and uses the Radio Frequency (RF) energy. If it is not installed correctly or not used as per the manual, RF interference to other equipment could result.**
-
-

NOTE

- **Save the packing case and packaging material as they can be used if the device must be reshipped.**
-

3.2 Environmental Requirements

The operating environment of the system must meet the requirements specified in this manual.

The equipment operating environment should be reasonably free from noises, vibration, dust, corrosive, flammable and explosive substances.

When the device is moved from one place to another, condensation may occur as a result of temperature or humidity difference. In this case, never start the system before the condensation disappears.

WARNING

- **Make sure that the device operating environment meets the specifications. Otherwise unexpected consequences, e.g. damage to the device, could result.**
-

NOTE

- **The system transmits data through a wireless connection. External radio frequency interference may result in occasionally data dropout. Contact Mindray for any questions regarding the electromagnetic environment.**
-

3.3 Connecting the ECG Leadwire

1. Align the ECG leadwire plug with the ECG connector as indicated by the arrow in the following figure.

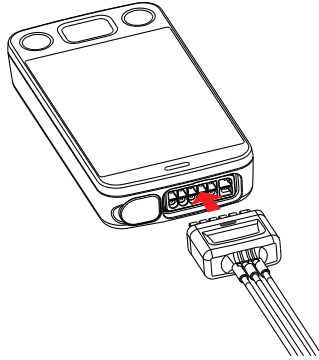

2. Insert the ECG leadwire plug into the ECG connector as shown in the enlarged figure below.

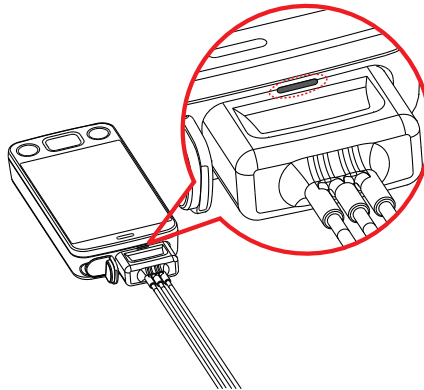

WARNING

- **Insert the ECG lead set into the ECG connector. The following performance may be affected by a weak connection:**
 - ◆ **ECG signal quality**
 - ◆ **Wireless signal strength**
 - ◆ **Water resistance**
 - **Do not use the ECG leadwire to move or lift the TD60/TM80. This may cause the device to fall, which may damage the equipment or injure the patient.**
-
-

NOTE

- **ECG leadwires are used as the antenna for the TD60. To ensure good radio performance, always connect the ECG leadwires to the ECG connector while monitoring the patient.**
 - **Insert the SpO₂ cap in the SpO₂ connector when SpO₂ is not in use.**
-

3.4 Installing the Batteries

You can use two AA, three AA batteries or a lithium-ion rechargeable battery pack to power the TD60 and use three AA batteries or a lithium-ion rechargeable battery pack to power the TM80.

The runtime is dependent on the battery configuration chosen. A lithium-ion battery pack will provide the longest runtime. For details about the recommended AA batteries, refer to *"Miscellaneous" on page 17 - 5*.

NOTE

- **Always keep the battery compartment dry.**
 - **The lithium-ion battery pack or AA battery tray should be placed in the correct direction and should not be installed in reverse.**
 - **Never use brute force to install the lithium-ion battery pack or AA battery tray. Otherwise the waterproof ring surrounding the battery frame edge may be broken to affect the waterproof performance.**
-

3.4.1 Installing the Lithium-ion Rechargeable Battery Pack

WARNING

- **Only use specified lithium-ion rechargeable batteries. Use of other lithium-ion batteries will adversely affect the batteries:**
 - ◆ **Level reporting**
 - ◆ **Low battery alarms**
 - ◆ **Life performance**
-

NOTE

- **The lithium-ion rechargeable battery pack should be fully charged prior to first use.**
-

1. Make sure that the battery compartment is empty.
2. Align the hook on the upper part of the lithium-ion battery pack with the slot on the battery compartment, as indicated by the enlarged figure below.

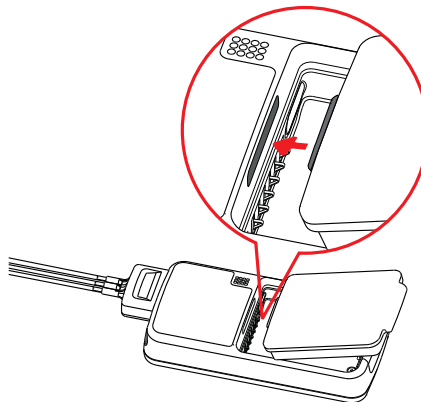

3. Press down the battery pack until it is installed firmly, as indicated by the arrow in the following figure.

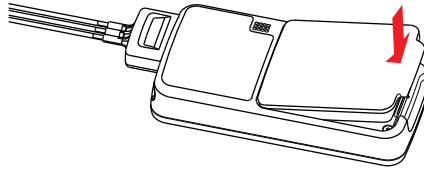

3.4.2 Installing the AA Batteries

There are two types of AA battery trays, which are used for holding AA batteries:

- TP-2AA battery tray (for the TD60 only) can hold two AA batteries.
- TP-3AA battery tray (for both the TD60 and the TM80) can hold three AA batteries.

To install the AA batteries:

1. Make sure the battery compartment is empty.
2. Insert two or three 1.5V alkaline AA batteries according to the diagram in the bottom of the battery tray as shown in the images below.

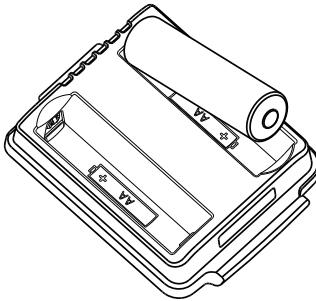

Installing two AA batteries

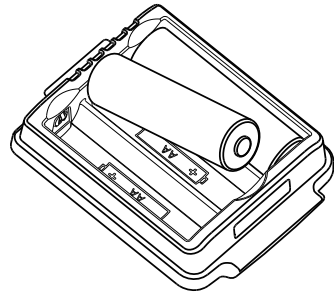

Installing three AA batteries

3. Align the hook on the upper part of the battery tray with the slot on the battery compartment, as indicated by the enlarged part in the following figure.

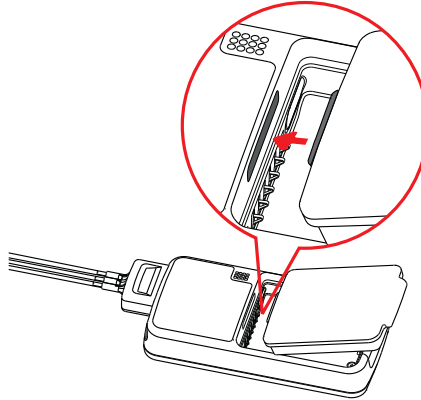

4. Press down the battery tray until it closes firmly, as indicated by the arrow in the following figure:

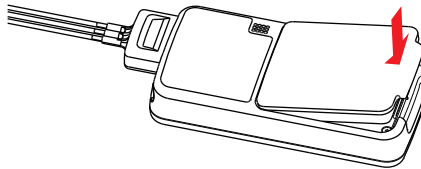

3.5 Powering On the Unit

When the rechargeable lithium-ion pack or AA battery tray is properly installed into the compartment door, the TD60/TM80 will be powered on automatically.

When the TD60/TM80 is powered off, press the  key to turn on the TD60/TM80. The cyan alarm light will momentarily turn on to indicate that the device is starting. The device performs a self-test during startup. The device sounds a beep, and the alarm light serially turns red, yellow, cyan, and then off. This indicates that the alarm system functions correctly.

Upon powering up, there are two situations:





- When the TD60/TM80 is turned on for the first time, the device will request you to configure first time startup. Please make your desired configurations as prompted.
- When the TD60/TM80 is turned on the next time, the device will prompt whether it is a new patient. Select **Yes** or **No** as desired. If the device is a lock mode, a pass-code is required.

WARNING

- **Check that visual and auditory alarm signals are presented correctly when the equipment is powered on. Do not use the equipment for any monitoring procedure on a patient if you suspect the equipment is not working properly or if the equipment is mechanically damaged. Contact your service personnel or Mindray.**

3.6 Understanding Touch Gestures

Before using the TD60/TM80, understand the supported touch screen gestures:

Gesture	Description
 Tap	Briefly touch the surface with your fingertip to select a target.
 Press and hold	Touch the surface for extended period of time.
 Drag	Move your fingertip over the surface without losing contact.
 Swipe	Quickly brush the surface with your fingertip.

3.7 Basic Operations

This section describes the basic operations for the TD60/TM80.

WARNING

- **Patients should be instructed not to interact with the display of the device and to not open the battery compartment while the TD60/TM80 is in use.**

3.7.1 Understanding the Screen Display Orientation

The TD60/TM80 supports both the portrait and landscape display orientations.



Example of portrait display

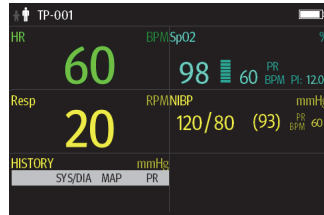

Example of landscape display

- Portrait: both digital and waveform tiles take up the entire width of the screen.
- Landscape: the digital tile takes up one half of the width of the screen; the waveform tile takes up the entire width of the screen.

3.7.2 Browsing the Screen Display

- To scroll the screen display, drag your finger up or down on the screen.
- To quickly move through the parameters, Swipe your finger up or down on the screen.

3.7.3 Switching the Screen Display Orientation

1. Swipe your finger down from the top of the main screen to display the drop-down menu.
2. Tap the desired option to switch the screen display orientation.

For example, to switch from portrait display to landscape display:

1. Swipe your finger down from the top of the main screen to display the drop-down menu.
2. Tap **Landscape** to switch to landscape display.

3.7.4 Flipping the Landscape Display

1. Swipe your finger down from the top of the main screen to display the drop-down menu.
2. Tap **Flip Display** to horizontally flip the landscape display.

3.7.5 Displaying the Quick Keys Area

Swipe your finger up from the bottom of the main screen to display the quick keys area.

The following table lists the six default quick keys:

Quick keys	Description
Discharge Patient	Tap the button to enter the Discharge Patient menu. Refer to <i>"Discharging the Patient" on page 5 - 4</i> for details.
Standby	Tap the button to enter the Standby Mode menu. Refer to <i>"Placing a Device in Standby" on page 5 - 3</i> for details.
Change Lead	Tap the button to change the current first ECG lead waveform to the next ECG lead waveform that is available in sequential order. For example, if the current first ECG lead waveform is I lead, tap the button, the I lead waveform is changed to II lead waveform.
Print	Tap the button to notify the CMS to start real-time print. The "Print Initiated" message displays on the screen.
Manual Event	Tap the button to notify the CMS to save the event to the event database. The "Manual Event" message displays on the screen.
Alarm Reset	Tap the button to reset the alarm system. Refer to <i>"Resetting Alarms" on page 6 - 5</i> for details.

You can customize the most frequently used functions to the quick keys. For details about setting the quick keys, refer to *"Quick Keys Menu" on page 11 - 5*.

3.7.6 Entering the Main Menu

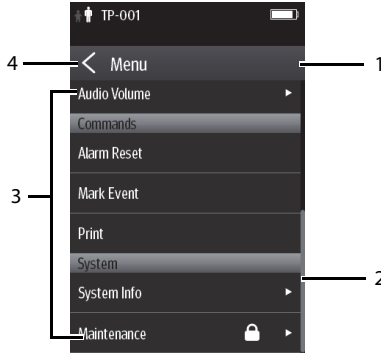

Press the  key to enter the main menu.

The main menu allows access to most of the system functions and settings.



All menus contain the following parts:

1. Heading: displays the current menu title.
2. Scroll bar: drag the bar to scroll the menu.
3. Main body: contains menus, buttons, and other controls to configure and operate the device.

Controls	Description
	Accesses a submenu to reveal more options or information.
	Indicates that a password is required for access.
Submenus	Contains more operations or information related to the corresponding menu.
Buttons	Provides an option to operate a function.
Switch 	Drag to right to enable the switch; drag to left to disable the switch.

4.  exits the current menu and return to the previous menu or the main screen, and saves any modified settings.

3.7.7 Turning the Display Off

You can manually turn the display off, or let the display automatically turn off based on the configured timeout.

- Press the  key to manually turn the display off.
- If the touch screen is not touched for the configured **Display Auto Off** time, then the screen will turn off after the configured **Display Auto Off** time has elapsed.

For details about configuring the time for **Display Auto Off**, refer to "**Configuring the General Menu**" on page 11 - 2.

NOTE

-
- **While the display is off, the TD60/TM80 enters the power saving mode, and does not provide audio and visual alarms.**
-

3.7.8 Turning the Display On



If the screen is off, press the  or  key to turn the display on.

CAUTION

- **Do not let the display directly touch the patient when the display is on.**
-



3.7.9 Unlocking the Screen in Locked Mode

If you set the screen lock, you need to input the correct passcode to unlock the screen after the display turns off.

1. If the screen is off, press the  or  key to turn the display on and access the **Screen Locked** menu.
2. Input the passcode to unlock the screen.

Once the passcode is entered the screen is temporarily unlocked. If the  is pressed or the device times out, the screen will lock again and a passcode must be entered.

3.7.10 Unlocking the Screen in View Only Mode

1. If the screen is off, press the  or  key to turn the display on.
2. Press the  key to display the **Screen Locked** menu.
3. Input the passcode to unlock the screen.

Once the passcode is entered the screen is temporarily unlocked. If the  is pressed or the device times out, the screen will lock again and a passcode must be entered.

For details about setting the screen lock, refer to **"Screen Lock Menu" on page 11 - 14**.

3.7.11 Acknowledging the Nurse Call

To acknowledge the triggered nurse call, tap **Attendant Present** in the main menu. The "Nurse Call Cancelled" message will display in the message area.

For details about how to trigger a nurse call, refer to **"Physical View" on "page 5"**.

WARNING

- **Do not only rely on the nurse call function, the medical personnel should also pay close attention to the patient's condition.**
-
-

3.8 Using the Pouch

The TD60/TM80 is not intended for direct contact with the patient's skin. During normal use, the TD60/TM80 should be worn over clothing, in a pocket, or in a pouch. The waterproof pouch with a clear window front is an appropriate means for holding the TD60/TM80. Disposable pouches specified in this manual can be used for the TD60/TM80. For details about the pouch, refer to **"Miscellaneous" on page 17 - 5**.

For how to use the pouch for BP10, refer to **BP10 Operator's Manual**.

CAUTION

- **If a patient needs to take a shower, check the TD60/TM80 as described in *Regular Check* on *Page 16-3* before showering, use the specified disposable pouch only, and secure the pouch on the patient as described in this section.**
 - **During showering, do not let water enter or accumulate in the pouch. Besides, do not perform SpO₂ or NIBP measurement.**
 - **When the patient is showering, signal quality and leads off detection may be compromised due to significant movement. Appropriate clinical precautions must be taken.**
-

3.8.1 Securing the Pouch for the TD60/TM80

To secure the pouch:

1. Place the TD60/TM80 into the pouch with the ECG leadwires and the SpO₂ sensor cable, if used, exiting from the pouch opening, as shown in the following figures.

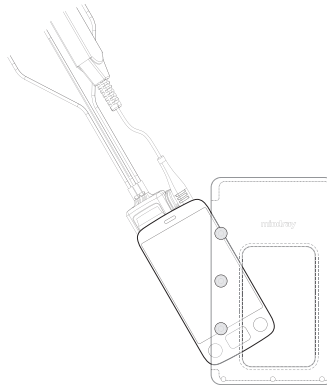

For disposable pouch

2. Pinch the snap-fastener to close the pouch.
3. Secure the pouch on the patient with ties around the patient's shoulder and under the arm, as shown in the following figure.

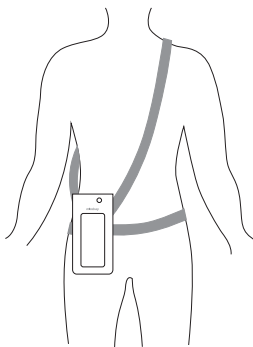

Wearing the disposable pouch

WARNING

- **While using a pouch with the TD60/TM80 on the patient, consider the patient's condition. Be careful about the placement of the straps, as the straps could present a strangulation hazard.**
-
-

NOTE

- **The pouch is used only for the TD60/TM80. The pouch cannot be used for carrying other personal devices, such as a mobile phone.**
-

3.8.2 Securing Pouches for the TD60/TM80 and BP10

When a patient wears the pouches for the TD60/TM80 and BP10 simultaneously, follow steps in **3.8.1 Securing the Pouch for the TD60/TM80** to secure the pouch for the TD60/TM80 on the left or right side of the patient's body and follow steps in **BP10 Operator's Manual** to secure the pouch for the BP10 on the right or left side of the patient's body, as shown in the following figures.

NOTE

- **Do not secure the pouches for the TD60/TM80 and BP10 on the same side of the patient's body.**
-

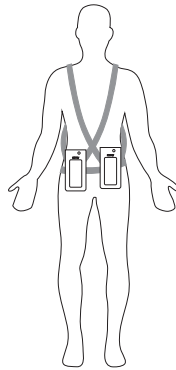

Wearing the disposable pouches

4

User Configurations

Introduction	4-2
Configuring the Display	4-2
Configuring the Audio Volume	4-4

4.1 Introduction

This chapter gives you an overview of basic operations related to the TD60/TM80, such as configuring the Display Setup, and Audio Volume.

4.2 Configuring the Display

You can configure the display by setting the display layout, display orientation, and screen brightness.

In the main menu, tap **Display Setup** to enter the **Display Setup** menu.

4.2.1 Setting the Default Display Orientation

For details about the display orientation, refer to *"Understanding the Screen Display Orientation" on page 3 - 11*.

1. In the **Setup** section of the **Display Setup** menu, tap **Default Orientation**.
Two buttons display: **Portrait** and **Landscape**.
2. Tap a button to set the default orientation.
The selected orientation displays to the right of **Default Orientation**.
3. Restart the TD60/TM80 to apply the setting.

4.2.2 Understanding Portrait Orientation Display Rules

In portrait orientation, both digital and waveform areas take up the entire width of the screen. Therefore, these parameters will be displayed in the exact order of the **Display Setup** menu, provided the sensor is attached and monitoring data.

4.2.3 Setting the Portrait Display

1. In the **Portrait** section of the **Display Setup** menu, tap **Rows**.
Three options display: **2**, **3**, and **4**.
2. Tap an option to set the row numbers.
The selected option displays to the right of **Rows**.
3. Tap **Portrait Order** to enter the **Portrait Order** menu.
4. Tap a parameter or waveform to select it.
The  icon displays to the right of the selected parameter or waveform.



5. Drag the selected parameter or waveform to the desired position, and then release it.
6. Repeat steps 4 and 5 until the desired order is configured.
7. Tap the  icon to exit the **Portrait Order** menu.

4.2.4 Understanding Landscape Orientation Display Rules

In landscape orientation, waveform areas take up the entire width of the screen. Digital areas only take up one half of the width of the screen. The following rules define how the tiles will be laid out:

1. The areas shall be displayed in the order of the **Display Setup** menu except the digital area locations shall be optimized to reduce blank tiles.
2. A waveform area always takes up the entire width of the screen.
3. A digital area always takes up one half of the width of the screen. Therefore, a row with a digital tile in it shall be split into two half tiles.
4. A digital area shall not be the only parameter in a row unless an odd number of digital areas exist. In this case, the last digital parameter area shall have one tile on the left side and the right half will be blank.
5. Digital areas shall be paired with the next available digital area to satisfy rule 4. This means that a digital area may be moved ahead of a waveform area if a half of a row needs to be filled.

4.2.5 Setting the Landscape Display

1. In the **Landscape** section of the **Display Setup** menu, tap **Rows**.
Three options display: **2**, **3**, and **4**.
2. Tap an option to set the row numbers.
The selected option displays to the right of **Rows**.
3. Tap **Landscape Order** to enter the **Landscape Order** menu.
4. Tap a parameter or waveform option to select it.
The  icon displays to the right side of the selected parameter or waveform.
5. Drag the selected parameter or waveform to the desired position, and then release it.
6. Repeat steps 4 and 5 until the desired order is configured.
7. Tap the  icon to exit the **Landscape Order** menu.

4.2.6 Setting the Display Brightness

1. In the **Setup** section of the **Display Setup** menu, tap **Display Brightness**.
The **Display Brightness** menu displays.
2. Drag the slider to left or right to adjust the brightness.
3. Tap the  icon to exit the **Display Brightness** menu.

4.3 Configuring the Audio Volume

You can independently set the technical alarm volume, touch screen click, and systole beep volume. The method for setting the three volumes are the same.

To change the volume settings:

1. In the main menu, tap **Audio Volume**.
2. In the **Technical Alarm**, **Touch Screen Click**, or **Systole Beep** section, drag the slider to the left or right to adjust the volume.
3. Tap the  icon to exit the **Audio Volume** menu.

NOTE

-
- The  icon indicates that the audio volume is turned off.
 - The minimum value for the technical alarm volume depends on the minimum technical alarm volume, refer to "Configuring the Alarms Menu" on page 11 - 3 for details.
-

5

Patient Management

Introduction	5-2
Admitting a Patient	5-2
Changing the Patient Category	5-2
Placing a Device in Standby	5-3
Exiting the Standby Mode	5-4
Discharging the Patient	5-4

5.1 Introduction

The chapter describes how to admit a patient, change the patient category, enter and exit the Standby mode, and discharge the patient.

5.2 Admitting a Patient

5.2.1 Admitting a Patient at the TD60

When using the TD60 for the first time, you should admit a patient at the Central Monitoring System (CMS). For details about admitting a patient through the CMS, refer to the *BeneVision Central Monitoring System Operator's Manual*.

After first admitting the patient at the CMS, you can directly admit next new patient at the TD60 by discharging the current patient. Refer to *"Discharging the Patient" on page 5 - 4* for details.

5.2.2 Admitting a Patient at the TM80

For the TM80, after discharging the current patient, you can admit a new patient by pressing the  button. For how to discharge a patient, refer to *"Discharging the Patient" on page 5 - 4*. After admitting a patient, please check the patient category and make changes appropriately.

5.3 Changing the Patient Category

NOTE

- **Select a correct patient category according to the patient's condition before monitoring begins.**
-

1. In the main menu, tap **Patient Info**.
2. In the **Patient Info** menu, tap **Patient Category** to select the desired patient category.
The screen displays the "Are you sure you want to change patient category?" message.
3. Select **Yes** to confirm the changing.
The selected patient category displays to the right of **Patient Category**.

4. Tap the  icon to save the settings and exit the **Patient Info** menu.

NOTE

- **When the device is connected to the CMS, the patient category at the CMS is updated if the patient category is changed at the TD60/TM80. Refer to the *BeneVision Central Monitoring System Operator's Manual* for details.**
-

5.4 Placing a Device in Standby

NOTE

- **When connected to the CMS, and a device enters or exits Standby mode, the CMS is also notified to enter or exit Standby mode. Refer to the *BeneVision Central Monitoring System Operator's Manual* for details.**
-

To enter the Standby mode:



1. In the main menu, tap **Standby**.
2. In the **Standby** confirmation menu, tap **Yes**.

Placing a device into Standby mode does the following:

- Suspends patient monitoring
- Alarm system is suspended
- Removes all patient data from the screen and displays **Standby Mode** on the screen.
- The screen display automatically turns off after the device enters the Standby mode for 30 seconds.
- Notifies the CMS of the standby mode

5.5 Exiting the Standby Mode

There are two ways to exit the standby mode:

- Press  once to turn off the display and press it twice to exit the standby mode.
- Press  to exit the standby mode.

After exiting the Standby mode, the system responds as follows:

- Restores parameter measurement as previously configured.
- Alarm system is activated.
- Notifies the CMS of returning to normal monitoring.

5.6 Discharging the Patient

Discharging the patient will stop monitoring at the TD60/TM80 and CMS. After discharging the patient, the patient's configuration is cleared at the TD60/TM80. The TD60/TM80 can admit next new patient by applying the user configuration. If the TD60/TM80 does not save the user configuration, the TD60/TM80 will apply the default departmental settings for the new patient.

You can discharge the patient by selecting the **Discharge Patient** menu or restarting the TD60or TM80.

NOTE

-
- **When the TD60/TM80 is connected to a CMS, the patient being discharged from the TD60/TM80 is also discharged from the CMS. Refer to the *BeneVision Central Monitoring System Operator's Manual* for details.**
-

5.6.1 Selecting the Discharge Patient menu

1. In the main menu, tap **Discharge Patient**.
2. In the **Discharge Patient** confirmation menu, select **Yes**.
 - ◆ The patient is discharged from both the TD60/TM80 and the CMS.
 - ◆ The patient's configuration is cleared and the default departmental settings are restored.
 - ◆ The discharged patient window of the CMS adds a record of the patient's history data.

3. Press the  key to start monitoring by applying the default departmental settings.

5.6.2 Restarting the TD60/TM80

1. If the TD60/TM80 is powered off, press the  key to turn on the device.
The device prompts whether this is a new patient or not.
2. Select **Yes** to enter the **Discharge Patient** confirmation menu.
3. Select **Yes** to clear the current patient's configuration and start monitoring by applying the user configuration.

If the TD60/TM80 does not save the user configuration, the TD60/TM80 will apply the default departmental settings for the new patient.

This page intentionally left blank.

6

Alarms

Introduction	6-2
Alarm Categories.....	6-2
Alarm Levels.....	6-2
Alarm Indicators	6-3
Configuring Alarms.....	6-5
Resetting Alarms.....	6-5

6.1 Introduction

Alarms, triggered by technical problems, are visually and audibly indicated to the user when the display is on.

The TD60/TM80 provides a subset of the technical alarms, this chapter describes the technical alarms presented at the TD60/TM80 only. For details regarding full list of the technical alarms as well as the physiological alarms displayed at the Central Monitoring System (CMS), refer to **"Physiological Alarms" on page 12 - 2**.

WARNING

- **The reception failure of alarm signals may occur in the distributed alarm system.**
-
-

6.2 Alarm Categories

The TD60/TM80's alarm system only supports technical alarms and does not provide visual or audible physiological alarms at the Device. These physiological alarms can only be viewed at the CMS. See ***BeneVision Central Monitoring System Operator's Manual*** for details on physiological alarms.

Technical alarms are triggered by system status, patient status, a device malfunction or a patient data distortion due to improper operation or mechanical problems. Technical alarms are available both at the TD60/TM80 and the CMS.

In addition to the technical alarms, the TD60/TM80 also displays informational message to inform the user of patient/system status. The TD60/TM80 will display informational messages in the message area at the top of the display.

6.3 Alarm Levels

The alarms can be classified into three severity levels: high level, medium level and low level.

Alarm Levels	Technical alarms
High level	Indicates a severe device malfunction or an improper operation, which could make it possible that the monitor cannot detect critical patient status and thus threaten the patient's life, such as low battery.
Medium level	Indicates a device malfunction or an improper operation, which may not threaten the patient's life but may compromise the monitoring of vital physiological parameters.

Alarm Levels	Technical alarms
Low level	Indicates a device malfunction or an improper operation, which may compromise a certain monitoring function but will not threaten the patient's life.

6.4 Alarm Indicators

When a technical alarm occurs, the TD60/TM80 notifies the user through visual or audible alarm indications.

- Alarm light
- Audible alarm tones
- Alarm message

NOTE

- **When the TD60/TM80 display is off, the user must activate the screen to view any local alarms.**

6.4.1 Alarm Light

If a technical alarm occurs, the alarm light on the TD60/TM80 flashes. The color and flashing frequency correspond to the alarm level as follows:

- High level alarms: the lamp quickly flashes red.
- Medium level alarms: the lamp slowly flashes yellow.
- Low level alarms: the lamp lights cyan without flashing.

6.4.2 Alarm Tones

The TD60/TM80 has three alarm tone configurations: ISO, Mode 1 and Mode 2. For each configuration, the alarm tones enunciate the alarm levels as follows:

- ISO pattern:
 - ◆ High level alarms: triple+double+triple+double beep
 - ◆ Medium level alarms: triple beep
 - ◆ Low level alarms: single beep
- Mode 1:

- ◆ High level alarms: high-pitched single beep
- ◆ Medium level alarms: double beep
- ◆ Low level alarms: low-pitched single beep
- Mode 2:
 - ◆ High level alarms: high-pitched triple beep
 - ◆ Medium level alarms: double beep
 - ◆ Low level alarms: low-pitched single beep

NOTE

- **When multiple technical alarms of different levels occur simultaneously, the TD60/TM80 selects the alarm of the highest level to light the alarm light and sound alarms accordingly, while all the alarm messages scroll in the message area on the top of the screen.**



6.4.3 Alarm Messages

When a technical alarm occurs on the TD60/TM80 screen, the alarm message appears in the message area. The background color of the alarm message and the asterisk symbols (*) before the alarm message are designed to indicate the alarm level.

Alarms	Background color	Asterisk symbols (*)
High level alarms	red	***
Medium level alarms	yellow	**
Low level alarms	cyan	*

6.4.4 Alarm Status Symbols

The TD60/TM80 still uses the following symbols indicating the alarm status:

- : indicates the technical alarm audio is turned off.
- : indicates the alarm system is reset.

6.5 Configuring Alarms

- For details on configuring the technical alarm volume, refer to "Configuring the Audio Volume" on page 4 - 4.
- For details on configuring the technical alarm settings, refer to "**Configuring the Alarms Menu**" on page 11 - 3.
- For the CMS alarm configurations, refer to the **BeneVision Central Monitoring System Operator's Manual**.

6.6 Resetting Alarms

You can acknowledge the on-going alarms by resetting the alarms. After being reset the alarm system can respond to a subsequent alarm condition.

When a technical alarm occurs, follow this procedure to reset the TD60/TM80's alarm system.

- Press the  key to enter the main menu, and then tap **Alarm Reset** from the **Commands** section.

OR

1. Swipe your finger up at the bottom of the main screen to display the quick keys area.
2. Tap the **Alarm Reset** quick key to reset the alarm system.

When the alarm system is reset, depending upon the technical alarm there are several ways the alarm system may respond as follows:

- The alarm sound will be silenced, the alarm light will continue to indicate the alarm, a ✓ will appear before the alarm message. The  symbol appears on the top of the main screen.
- The technical alarm will be changed to the prompt message, it will not longer make sound or be indicated by the alarm light.
- The technical alarms are cleared, there will be no alarm indications.

For details about the indications of technical alarms when the alarm system is reset, refer to "**Technical Alarm Messages at the TD60/TM80**" on page 14 - 7.

This page intentionally left blank.

7

Monitoring ECG

Introduction	7-2
Safety.....	7-2
Preparation for Monitoring ECG	7-3
Maintaining Quality ECG Signal.....	7-13
Understanding the ECG Display	7-17

7.1 Introduction

The chapter describes the ECG monitoring function of the TD60/TM80, including skin preparation and lead placement, ECG Setup, ECG Waveform, and Pacer.

The TD60 can obtain an ECG value by using a 3/5 lead ECG leadwires in conjunction with the matching skin electrodes.

The TM80 can obtain an ECG value by using a 3/5/6 lead ECG leadwires in conjunction with the matching skin electrodes.

For details about CMS configuration of the ECG parameters, QT analysis, ST analysis, and Arrhythmia analysis, refer to **Chapter 12 Monitoring with the TMS60/TM80 at the CMS**.

7.2 Safety

WARNING

- **This equipment is not suitable for direct cardiac application.**
 - **Use manufacturer specified electrodes and lead wires.**
 - **Make sure the conductive parts of electrodes and associated connectors for applied parts, including the neutral electrode, do not contact any other conductive parts including earth.**
 - **Periodically inspect the electrode application site to ensure skin quality. If the skin quality changes, replace the electrodes or change the application site.**
 - **Do not touch the patient or any device connected to the patient, including the bed and gurney, during defibrillation. Otherwise serious injury or death could result.**
 - **False low heart rate indicators or false Asystole calls may result with certain pacemakers because of pacemaker artifact such as electrical overshoot of the pacemaker overlapping the true QRS complexes.**
-
-

CAUTION

- **Interference from a non-grounded instrument near the patient and electro-surgery interference can cause problems with the waveform.**
-
-

NOTE

- **After defibrillation, the waveform recovers within 10 seconds applied in accordance with the manufacturer's instructions for use.**
-

7.3 Preparation for Monitoring ECG

7.3.1 Preparing the Patient's Skin

Proper skin preparation is essential in obtaining an accurate ECG reading. Electrode sites should be clean and dry and should provide a smooth flat surface. Incidental electrical activity and inaccurate readings may arise from incorrect skin preparation.

The following procedure is recommended for secure electrode application:

1. Shave the chest hair from the electrode sites in a circular area with a diameter of 2 to 4 inches.
2. Use a dry gauze pad to remove excess skin oils, skin cells and residue from the electrode sites. Never rub the skin until it is raw or bleeding.

NOTE

- **Prepare the electrode site with alcohol only if the skin is extremely greasy. If alcohol is used as a drying agent, always allow the skin to dry before placing the electrode on the skin.**
-

7.3.2 Positioning the Electrodes

NOTE

- **Store electrodes at room temperature and open just prior to use.**
 - **Avoid more than one type of electrode on a patient because of variations in electrical resistance.**
 - **Avoid placing electrodes directly over bone prominences or over any high activity movement areas such as shoulders or arms because muscle motion produces electrical activity. If an electrode is placed over a large muscle such as the pectorals, the device may detect this additional muscle activity and could lead to false arrhythmia calls.**
-

NOTE

- **Using a Transcutaneous Electrical Nerve Stimulator (TENS): Since a TENS unit transmits electrical impulses, avoid placing ECG electrode near the TENS electrodes. ECG electrodes may need to be repositioned and the ECG lead viewed may need to be adjusted until the optimum ECG tracing is obtained.**
-

1. Peel the backing off of the electrode. Visually inspect the contact gel medium for moistness. If the gel medium is not moist, do not use the electrode patch. Dry electrode patches are not conductive.

NOTE

- **To prevent evaporation of the contact gel medium, peel the backing off of the electrode patch only when it is ready for use.**
 - **If using the snap type lead wires, attach the electrode to the lead wire before placing the electrode on the patient.**
-

2. Attach the electrode patch to the skin at the prepared site. Smooth the electrode patch down in a circular motion to ensure proper skin contact. If using soft gel electrodes, never push down directly over the contact gel medium as this may displace the gel and cause monitoring artifact. If using hard gel electrodes, it is recommended that during application, the center of the electrode should be slightly pressed onto the skin to ensure direct contact. Consult the electrode manufacturer's instructions for specific use.
 3. Secure the lead wires to the patient according to hospital practice.
-

CAUTION

- **Route leadwires neatly. Ensure leadwires are kept away from patient's neck to avoid strangulation. Keep floors and walkways free of cables to reduce risk to hospital personnel, patients and visitors.**
-

NOTE

- **It is recommended that the electrodes be changed at least every 24 to 36 hours to maintain proper contact with the skin, although some patients may require more frequent changing. Do not reapply disposable electrode. Try to avoid reusing the exact same electrode site during reapplication. If an electrode becomes wet with fluid, change the electrode.**
-

7.3.3 Setting ECG Lead Labeling

7.3.3.1 Lead Naming Standards

This manual presents lead placement according to the guidelines of the American Heart Association (AHA) and the International Electro-Technical Commission (IEC).

Lead position	AHA		IEC	
	Label	Color	Label	Color
Chest	V	Brown	C	White
Left Leg	LL	Red	F	Green
Right Leg	RL	Green	N	Black
Left Arm	LA	Black	L	Yellow
Right Arm	RA	White	R	Red

7.3.3.2 Choosing Lead Labeling

For details on choosing the lead labeling, refer to **"Configuring the General Menu" on page 11 - 2.**

7.3.4 Placing the Electrodes

For lead placement, the ECG algorithm works best when the patient's R wave is significantly larger than the P wave or the T wave. If the R wave is not significantly larger than other lower voltage waves on the ECG tracing, the monitor may have some difficulty in identifying the appropriate waves. On some patients, electrode placement and/or the viewed ECG lead may need to be adjusted in order to obtain a significant R wave.

7.3.4.1 Standard 3-Leadwire Electrode Placement

A 3-wire lead set can monitor one of three ECG vectors (I, II, or III). The recommended 3-wire lead placement is as follows:

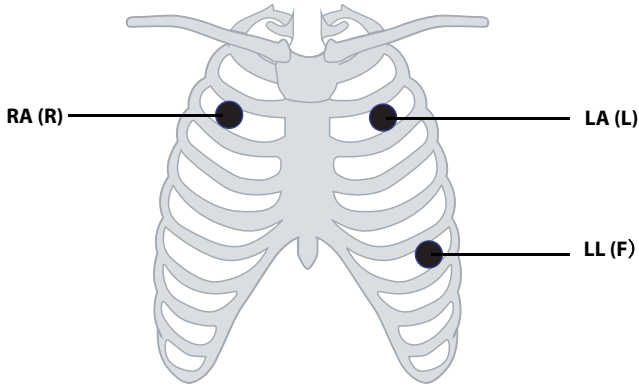

AHA	IEC	Electrode Placement
RA (white)	R (red)	At the patient's 2nd ICS midclavicular line to the right of the sternum.
LA (black)	L (yellow)	At the patient's 2nd ICS midclavicular line to the left of the sternum.
LL (red)	F (green)	On the patient's lower left chest wall within the ribcage frame.

7.3.4.2 Standard 5-Leadwire Electrode Placement

A 5-wire lead set can monitor seven ECG vectors (I, II, III, aVR, aVL, aVF, and V) simultaneously. The recommended 5-wire lead placement is as follows:

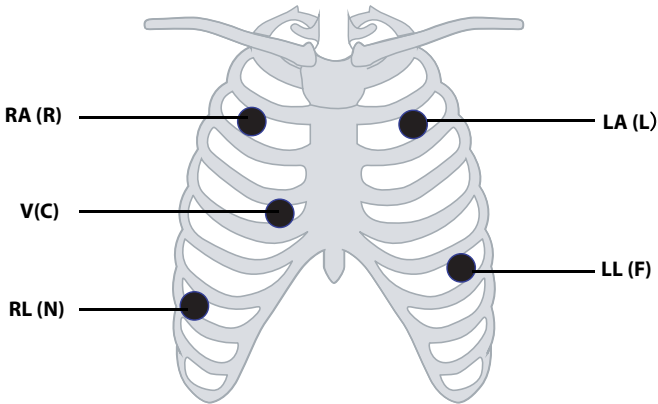

AHA	IEC	Electrode Placement
RA (white)	R (red)	At the patient's 2nd ICS mid-clavicular line to the right of the sternum.
LA (black)	L (yellow)	At the patient's 2nd ICS midclavicular line to the left of the sternum.
LL (red)	F (green)	On the patient's lower left chest wall within the ribcage frame.
RL (green)	N (black)	On the patient's lower right chest wall within the ribcage frame.
V (brown)	C (white)	V-lead (C-lead) position depicted in the figure above, or the V (C) electrode should be placed by a clinician.

7.3.4.3 Standard 6-Leadwire Electrode Placement (For the TM80 Only)

For a 6-lead placement, use the positions from the 5-lead diagram above but with two chest leads. The two chest leads are Va and Vb per AHA standard, and are Ca and Cb per IEC standard. Va (Ca) and Vb (Cb) can be positioned at any two of the V1 (C1) to V6 (C6) positions shown in the chest electrode diagram below. The default position of Va and Ca is V1 and C1 respectively. The default position of Vb and Cb is V2 and C2 respectively

The positions of Va (Ca) and Vb (Cb) can also be placed at a proper position according to the clinician's needs.

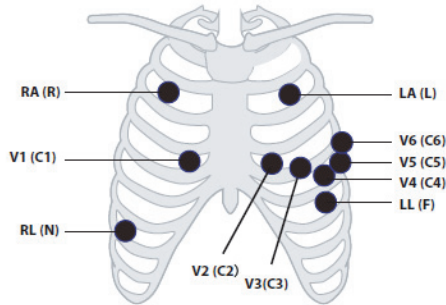

AHA	IEC	Electrode Placement
RA (white)	R (red)	At the patient's 2nd ICS mid-clavicular line to the right of the sternum.
LA (black)	L (yellow)	At the patient's 2nd ICS midclavicular line to the left of the sternum.
LL (red)	F (green)	On the patient's lower left chest wall within the ribcage frame.
RL (green)	N (black)	On the patient's lower right chest wall within the ribcage frame.
Va (brown)	Ca (white)	The Va (Ca) electrode is placed in any one of the positions from V1(C1)- V6(C6) positions. By default Va/Ca electrode is placed at V1(C1) and the Vb(Cb) electrode is placed at V2(C2).
V1 (brown)	C1 (white)	In the fourth intercostal space, right sternal border.

AHA	IEC	Electrode Placement
V2 (brown)	C2 (white)	In the fourth intercostal space, left sternal border.
V3 (brown)	C3 (white)	In the midway between V2 and V4 on a straight line.
V4 (brown)	C4 (white)	In the fifth intercostal space, mid-clavicular line.
V5 (brown)	C5 (white)	In the fifth intercostal space, anterior axillary line.
V6 (brown)	C6 (white)	In the fifth intercostal space, mid-axillary line.

7.3.4.4 Lead Placement: Pacemaker Patients

The recommended lead placement for monitoring a pacemaker patient is as follows.

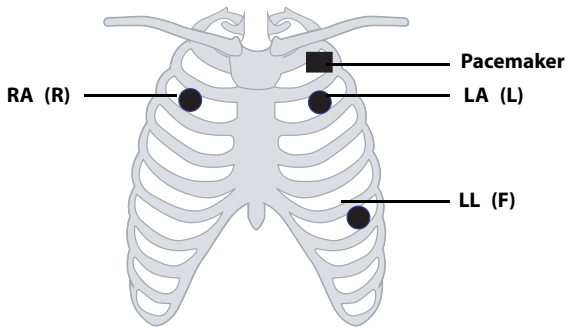

3-wire lead placement for a pacemaker patient (AHA)/(IEC)

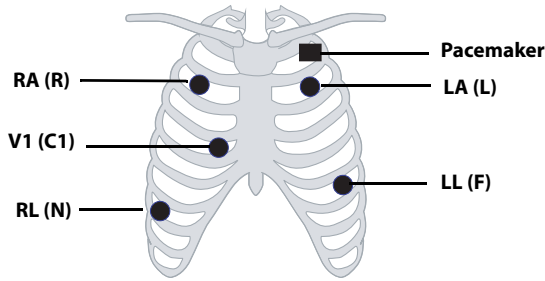

5-wire Lead Placement for a Pacemaker Patient (AHA)/(IEC)

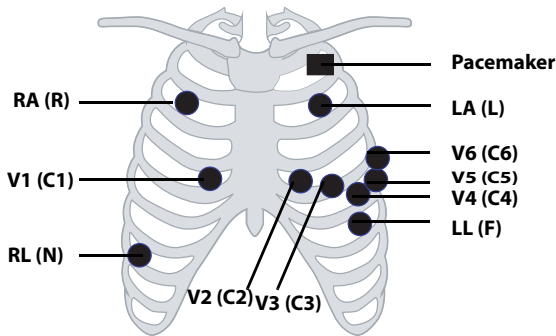

6-wire Lead Placement for a Pacemaker Patient (AHA)/(IEC) (For the TM80 Only)

A pacemaker patient usually requires a different electrode patch placement configuration than a non-pacemaker patient.

Do not place an ECG electrode directly over the pacemaker generator. Place the electrode patches 2 to 3 inches away from the pacemaker generator area. For example, if the pacemaker generator is located in the right subclavian area, relocate the Right Arm electrode closer in towards the center of the chest.

7.3.5 Checking the Lead Placement

With the Lead Placement function, you can check the lead status, information, and lead off messages.

7.3.5.1 Entering the Lead Placement Menu

Enter the **Lead Placement** menu in either of the following ways:

- Tap the lead fault message in the message area of the main screen.
- In the main menu, tap **Lead Placement**.

7.3.5.2 Understanding the Lead Placement Instructions

The **Lead Placement** window indicates the lead status.

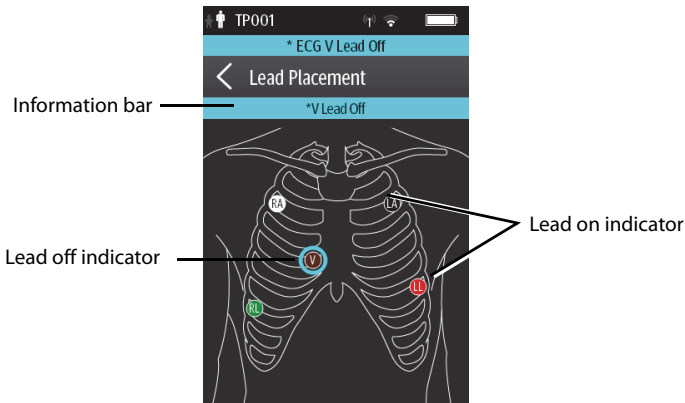

Example lead placement window





When any of the leads are off, the indications are as follows:

- The lead off message displays on the information bar.
The background color of the information bar corresponds to the alarm level.
- A flashing circle indicates the disconnected lead.
The color of the flashing circle is based on the alarm level.

7.3.6 Setting the Paced Status

It is important to correctly set the patient's paced status before you start monitoring ECG.

To set the paced status, follow this procedure:

1. Enter the ECG menu in either of the following ways:
 - ◆ On the main screen, tap the HR digital area or ECG waveform area to enter the **ECG** menu.
 - ◆ Press the  button to enter the main menu, tap **Parameter Setup**, and then tap **ECG**.
2. In the Paced section, tap **Paced** and select the correct paced status.
 - ◆ When **Paced** is set to **Yes** at the TD60/TM80, the  symbol displays in the waveform area of the Central Monitoring System's screen, and the pace pulse marks will display on the ECG waveform both at the TD60 and CMS.
 - ◆ When **Paced** is set to **No** at the TD60/TM80, the  symbol displays in the waveform area of the Central Monitoring System's screen.
 - ◆ When **Paced** is not set at the TD60/TM80, the  symbol displays in the waveform area of the Central Monitoring System's screen.

WARNING

- **For paced patients, you must set Paced to Yes. If it is incorrectly set to No, the CMS could mistake a pace pulse for a QRS and fail to alarm when the ECG signal is too weak. Do not rely entirely on rate meter alarms when monitoring patients with pacemakers. Always keep these patients under close surveillance.**
 - **The pacer pulses may be counted as QRS complexes, hence leading to wrong HR readings or failure to diagnose certain arrhythmia symptoms. Be sure to keep a close eye on patient's with pacemaker devices.**
 - **For non-paced patients, you must set Paced to No.**
 - **False low heart rate indicators or false asystole calls may result with certain pacemakers because of pacemaker artifact such as electrical overshoot of the pacemaker overlapping the true QRS complexes.**
 - **The auto pacer recognition function is not applicable to pediatric patients.**
-
-

WARNING

- **The radio frequency energy of the transmitter or other radio frequency sources, when used in close proximity to a pacemaker, may interfere with pacemaker performance. Internal pacemakers are less vulnerable than external pacemakers due to the shielding effects of the body. However, caution should be exercised when monitoring any paced patient.**
 - **In order to minimize the possibility of interference, place electrodes, leadwires and TD60/TM80 as far away from the pacemaker as possible.**
-
-

NOTE

- **When Paced is set to Yes, the system does not detect PVC-related arrhythmia (including PVCs) resulting from pacemaker but still analyzes the normal QRS complex.**
-

7.3.7 Maintaining Quality ECG Signal

Regardless of patient age, electrodes should be replaced at least every 24 hours to maintain quality signals during long-term monitoring. Over the course of 24 hours, the electrode gel will start to dry out and the adhesive will age. After a long period of time, the patient's sensitive skin also may be irritated by the gel or adhesive causing discomfort.

Stabilize the electrode and leadwire with a leadwire stress loop near the electrode. Tape the stress loop to the patient. A secured stress loop prevents leadwire rotation about the electrode snap, leadwire tugging at the electrode, and ECG artifact.

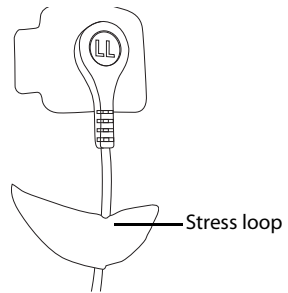

7.4 Changing the ECG Settings

You can change the ECG settings from the ECG menu.

7.4.1 Configuring the ECG Setup

Enter the ECG menu in either of the following ways:

- On the main screen, tap the HR digital area or ECG waveform area to enter the **ECG** menu.
 - In the main menu, tap **Parameter Setup** → **ECG** to enter the **ECG** menu.
1. In the **Setup** section of the **ECG** menu, select the options described in the following table.

Options	Description	Settings*
Lead Placement	Enters the Lead Placement window.	Refer to " Checking the Lead Placement " on page 7 - 11 for details.
Cable Type	Selects the current ECG leadwire type.	Auto , 3 Lead, 5 Lead Refer to " ECG Leadwire Types " on page 7 - 15 for details.
Smart Lead (Monitored Lead)	When Cable Type is set to Auto , the option displays Smart Lead . Drag the switch to right or left to enable or disable the Smart Lead function. When Cable Type is set to 3 Lead , the option displays Monitored Lead . Refer to " ECG Leadwire Types " on page 7 - 15 for details.	
Filter	Selects the ECG filter. Monitor Use under normal measurement conditions. ST Use when ST monitoring is applied.	Monitor , ST
Color	Selects the ECG waveform color.	16 colors The default color is green.

* The factory default settings are in bold.

2. Tap  to exit the **ECG** menu.

7.4.2 ECG Leadwire Types

ECG leadwire type has three options as follows:

- **Auto:** the device automatically sets the leadwire type according to the leads connected.
- **3 Lead:** the leadwire type is set to 3-lead.
If the leadwire type is set to 3-lead, the **Smart Lead** option becomes **Monitored Lead**. You can select the desired lead from the **Monitored Lead** option to set the first ECG waveform displayed on the main screen.
- **5 Lead:** the leadwire type is set to 5-lead.
All waveform leads display on the main screen.
- **6 Lead:** the leadwire types is set to 6 lead. This option is available for the TM80 only.
If the leadwire type is set to 6 lead, there will be two options **Va** and **Vb** displayed under **Cable Type**.
 - ◆ **Va** options: Va, V1, V2, V3, V4, V5, V6. Va is the default.
 - ◆ **Vb** options: Vb, V1, V2, V3, V4, V5, V6. Vb is the default.

7.4.3 Configuring the ECG Waveforms

1. In the **Waveform** section of the **ECG** menu, select the options described in the following table.

Options	Description	Settings*
All Lead Size	Selects the waveform size for all the leads. To set the waveform size for a specific lead, select that lead from the Waveform Size field.	1.25 mm/mV, 2.5 mm/mV, 5 mm/mV, 10 mm/mV , 20 mm/mV, 40 mm/mV, Auto
	This configuration will be applied for all ECG waveform size.	
Speed	Selects the waveform sweep speed.	6.25 mm/s, 12.5 mm/s , 25 mm/s

* The factory default settings are in bold.

2. Tap  to exit the **ECG** menu.

7.4.4 Configuring the Pacer

1. In the **Pacer** section of the **ECG** menu, tap the options described in the following table.

Options	Description	Settings*
Paced	Selects the paced status.	Unspecified , No, Yes Unspecified is only available for the first time you set the paced status. Refer to " Setting the Paced Status " on page 7 - 12 for details.
Markers	Selects the pacer indicator. Line A 1 cm line shows above each ECG waveform each time the pace pulse is detected. Dot A 2 mm dot shows above each ECG waveform each time the pace pulse is detected.	Line , Dot, Off
Pacer Reject	Selects whether or not to reject the pace pulses.	On, Off

* The factory default settings are in bold.

2. Tap  to exit the **ECG** menu.

NOTE

- **When Paced is set to Yes, the Makers and Pacer Rejection options can be available.**

7.4.5 Configuring the ECG Waveform Size

The **Waveform Size** field of the **ECG** menu lists all available leads. You can select the desired ECG lead to set the waveform size. For details about the waveform size setting, refer to "**Configuring the ECG Waveforms**" on page 7 - 15.

7.4.6 Setting the Notch Filter

Notch filter filters out AC line noise from the ECG waveform. Refer to "**Configuring the General Menu**" on page 11 - 2 for details.

7.5 Understanding the ECG Display

7.5.1 HR Digital Area

The HR digital area displays:

1. Parameter name
2. Measurement unit
3. Heart rate value

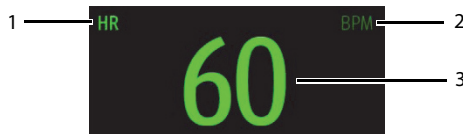

NOTE

- **Both the HR value displayed on the TM80's main screen and that at the Central Monitoring System can meet relevant standards and are reliable. HR trended, alarm checking, and arrhythmia are based on the HR calculated at the Central Monitoring System.**
- **Please be noted that in case of weak wireless signals, the Central Monitoring System faces the risk of data loss and the HR value calculated by the ECG algorithm for the Central Monitoring System may have certain deviation.**

7.5.2 About the HR Digital Area

- The HR area displays heart rate in the unit of bpm with a resolution of 1 bpm.
- If the HR measurement is invalid, "--" displays in place of the HR value.
- The HR value displays "0", when the HR value is less than 15 bpm.

7.5.3 ECG Waveform Area

The ECG waveform area displays:

1. ECG Lead
2. ECG scale bar
3. ECG waveform
4. ECG filter setting
5. ECG scale

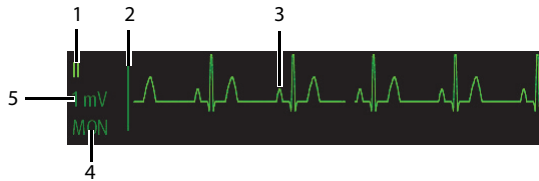

7.5.4 About the ECG Waveform Area

- The ECG waveform, scale indicator, lead, and filter settings display in the configured ECG color.
- The ECG waveform area provides scrolling, real-time waveform data and an erase bar to provide a time indicator of oldest and new data.
- The ECG waveform area scrolls the waveform in the configured sweep speed.
- The ECG waveform area rails the top most value when the waveform exceeds the upper scale limit for real-time waveforms.
- The ECG waveform area rails the bottom most value when the waveform exceeds the lower scale limit for real-time waveforms.
- The ECG waveform area indicates a Pacer indicator when a pace pulse is detected and Paced is enabled.

8

Monitoring Respiration (Resp) (Optional)

Introduction	8-2
Safety.....	8-2
Preparation for Monitoring Resp.....	8-3
Changing the Resp Settings.....	8-4
Understanding the Resp Display.....	8-6

8.1 Introduction

Impedance respiration is measured across the thorax. When the patient is breathing or ventilated, the volume of air changes in the lungs, resulting in impedance changes between the electrodes. Respiration rate (RR) is calculated from these impedance changes, and a respiration waveform appears on the patient monitor screen.

Resp monitoring is intended for adult and pediatric patients.

8.2 Safety

WARNING

- **If you do not set the detection level for the respiration correctly in manual detection mode, it may not be possible for the monitor to detect apnea. If you set the detection level too low, the monitor is more likely to detect cardiac activity, and to falsely interpret cardiac activity as respiratory activity in the case of apnea.**
 - **If operating under conditions according to the EMC Standard IEC 60601-1-2 (Radiated Immunity 3V/m), field strengths above 3V/m may cause erroneous measurements at various frequencies. Therefore, it is recommended to avoid the use of electrically radiating equipment in close proximity to the respiration measurement unit.**
 - **The impedance respiration measurement may cause rate changes in Minute Ventilation Rate Responsive Pacemakers. Set the pacemaker rate responsive mode off or disable the impedance respiration measurement on the monitor.**
-

CAUTION

- **Only use parts and accessories specified in this manual.**
 - **Respiration monitoring is not for use on the patients who are very active, as this will cause false alarms.**
-

8.3 Preparation for Monitoring Resp

8.3.1 Preparing the Patient's Skin

Follow this procedure to prepare the patient's skin:

1. Shave the chest hair from the electrode sites in a circular area with a diameter of 2 to 4 inches.
2. Use a dry gauze pad to remove excess skin oils, skin cells and residue from the electrode sites. Never rub the skin until it is raw or bleeding.

NOTE

-
- **Proper skin preparation is necessary for good signal quality at the electrode site, as the skin is a poor conductor of electricity.**
-

8.3.2 Positioning the Electrodes

As the Respiration measurement adopts the standard ECG electrode placement, you can use different ECG cables. Since the respiration signal is measured between two ECG electrodes, if a standard ECG electrode placement is applied, the two electrodes should be RA and LL of ECG Lead II.

For more information, see **.7.3.4** Placing the Electrodes.

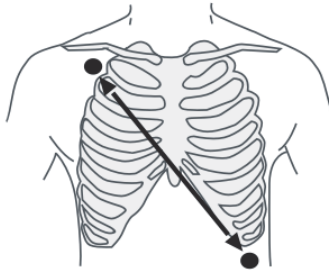

Lead II

CAUTION

- **Correct electrodes placement can help to reduce cardiac overlay: avoid the liver area and the ventricles of the heart in the line between the respiratory electrodes. This is particularly important for neonates.**
 - **Some patients with restricted movements breathe mainly abdominally. In these cases, you may need to place the left leg electrode on the left abdomen at the point of maximum abdominal expansion to optimize the respiratory wave.**
 - **In clinical applications, some patients expand their chests laterally, causing a negative intrathoracic pressure. In these cases, it is better to place the two respiration electrodes in the right midaxillary and the left lateral chest areas at the patient's maximum point of the breathing movement to optimize the respiratory waveform.**
 - **Periodically inspect the electrode application site to ensure skin quality. If the skin quality changes, replace the electrodes or change the application site.**
-

NOTE

- **Store the electrodes at room temperature. Open the electrode package immediately prior to use.**
 - **Check that the electrode packages are intact and not expired. Make sure the electrode gel is moist.**
-

8.4 Changing the Resp Settings

You can change the Resp settings from the **Resp** menu.

8.4.1 Configuring the Resp Setup

Enter the **Resp** menu in either of the following ways:

- On the main screen, tap the Resp digital area or waveform area to enter the **Resp** menu.
 - In the main menu, tap **Parameter Setup** → **Resp** to enter the **Resp** menu.
1. In the **Setup** section of the **Resp** menu, select the options described in the following table.

Options	Description	Settings*
NCM Alarm Delay	The TM80 will trigger the “No Chest Movement” alarm if the patient has stopped breathing for longer than the set apnea time. This alarm is displayed on the central monitoring system only.	10s, 15s, 20s , 25s, 30s, 35s, 40s
Color	Selects the Resp waveform color.	16 colors The default color is yellow.

* The factory default settings are in bold.

2. Press  to return to the main screen.

8.4.2 Configuring the Resp Waveform

1. In the **Waveform** section of the **Resp** menu, select the options described in the following table.

Options	Description	Settings*
Gain	Selects the waveform size.	x0.25, x 0.5, x 1, x2 , x3, x4, x5
Speed	Selects the waveform sweep speed.	3mm/s, 6.25 mm/s , 12.5 mm/s, 25 mm/s

* The factory default settings are in bold.

2. Press  to return to the main screen..

8.5 Understanding the Resp Display

8.5.1 Resp Digital Area

The Resp digital area displays:

1. Parameter name
2. Measurement unit
3. Respiration rate (RR)



8.5.2 About the Resp Digital Area

- The Resp digital area displays the respiration rate in the unit of RPM with a resolution of 1 RPM.
- If the Resp measurement is invalid, "--" displays in place of the RR value.

8.5.3 Resp Waveform Area

The Resp waveform area displays:

1. Resp lead label
2. Resp waveform
3. Resp waveform gain

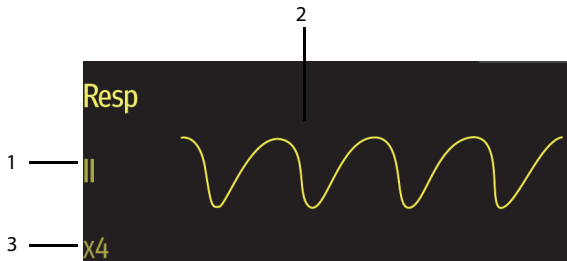

8.5.4 About the Resp Waveform Area

- The Resp waveform, lead label, and waveform gain display in the configured Resp color.
- The Resp waveform area scrolls the waveform at the configured sweep speed.

This page intentionally left blank.

9

Monitoring SpO₂ (Optional)

Introduction	9-2
Measurement Limitations.....	9-3
Safety.....	9-3
Connecting the SpO2 Module	9-5
Changing the SpO2 Settings	9-7
SpO2 Measurement	9-9
Understanding the SpO2 Display	9-11

9.1 Introduction

The chapter describes the SpO₂ monitoring function at the TD60/TM80 in detail, including connecting the SpO₂ module, configuring the SpO₂, and monitoring the SpO₂. For details about the SpO₂ parameter setup at the CMS, refer to **Chapter 12 Monitoring with the TMS60/TM80 at the CMS**.

SpO₂ monitoring is a non-invasive technique used to measure the amount of oxygenated hemoglobin and pulse rate by measuring the absorption of selected wavelengths of light. The light generated in the probe passes through the tissue and is converted into electrical signals by the photo detector in the probe. The SpO₂ module processes the electrical signal and displays a waveform and digital values for SpO₂ and pulse rate.

The TD60/TM80 can be configured with Masimo SpO₂ or Nonin SpO₂.

NOTE

- **A functional tester or SpO₂ simulator cannot be used to assess the accuracy of a SpO₂ module or a SpO₂ sensor.**
 - **This device is calibrated to display functional oxygen saturation.**
 - **A pulse oximeter should not be used as an apnea monitor.**
 - **Pulse rate measurement is based on the optical detection of a peripheral flow pulse and therefore may not detect certain arrhythmias. The pulse oximeter should not be used as a replacement or substitute for ECG based arrhythmia analysis.**
 - **The MS board pulse oximeter can be used during defibrillation, but the readings may be inaccurate for a short time.**
-

9.2 Measurement Limitations

If the SpO₂ measurement seems out of range or inaccurate, check the patient's vital signs. Then check the equipment and SpO₂ sensor. The following factors may influence the accuracy of measurement:

- Ambient light
- Physical movement
- Low perfusion
- Electromagnetic interference
- Dysfunctional hemoglobin, such as carboxyhemoglobin (COHb) and methemoglobin (MetHb)
- Presence of certain dyes, such as methylene and indigo carmine
- Inappropriate positioning of the SpO₂ sensor, or use of incorrect SpO₂ sensor
- Drop of arterial blood flow to immeasurable level caused by shock, anemia, low temperature or vasoconstrictor.

9.3 Safety

WARNING

- **Only use SpO₂ sensors specified in this manual. Follow the SpO₂ sensor's instructions for use and adhere to all warnings and cautions.**
 - **The operator is responsible for checking the compatibility of the pulse oximetry monitor, sensor, and patient cable prior to use. Incompatible components can result in degraded performance and/or device malfunction.**
 - **When a trend toward patient deoxygenation is indicated, blood samples should be analyzed by a laboratory co-oximeter to completely understand the patient's condition.**
 - **Do not use SpO₂ sensors during magnetic resonance imaging (MRI). Induced current could potentially cause burns. The sensor may affect the MRI image, and the MRI unit may affect the accuracy of the oximetry measurements.**
-
-

WARNING

- **Prolonged and continuous monitoring may increase the temperature of the sensor and cause the patient discomfort. It is especially important to check the sensor placement, and ensure proper attachment on patients suffering from poor perfusion or skin sensitivity. Check the sensor location every two to three hours and move to another location if the skin deteriorates. More frequent examinations may be required for different patients.**
 - **Check accessory compatibility prior to use. Incompatible accessories may degrade the device's performance and may cause harm to the patient.**
 - **Do not use disposable SpO2 sensor for multiple times. Otherwise, inaccurate SpO2 measurement may occur.**
-
-

9.4 Connecting the SpO₂ Module

Connect the SpO₂ module to the TD60/TM80. The TD60/TM80 can auto detect the SpO₂ module type when the SpO₂ module is connected.

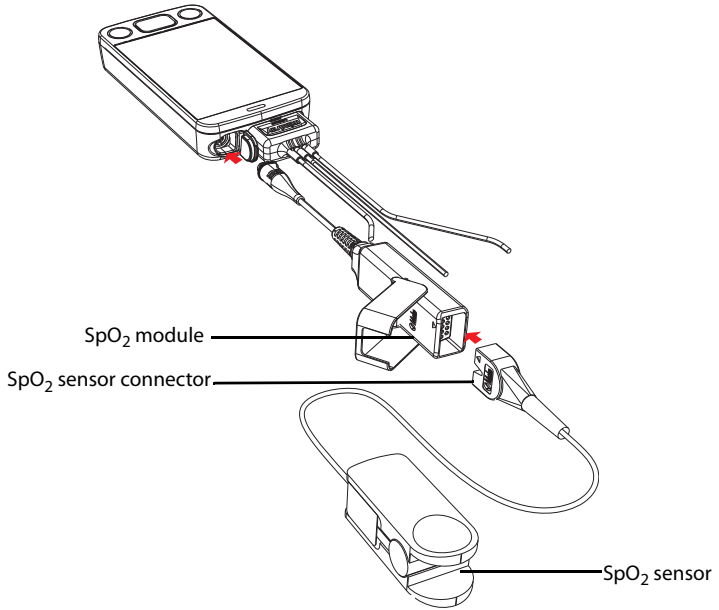

Connecting the Masimo SpO₂ module

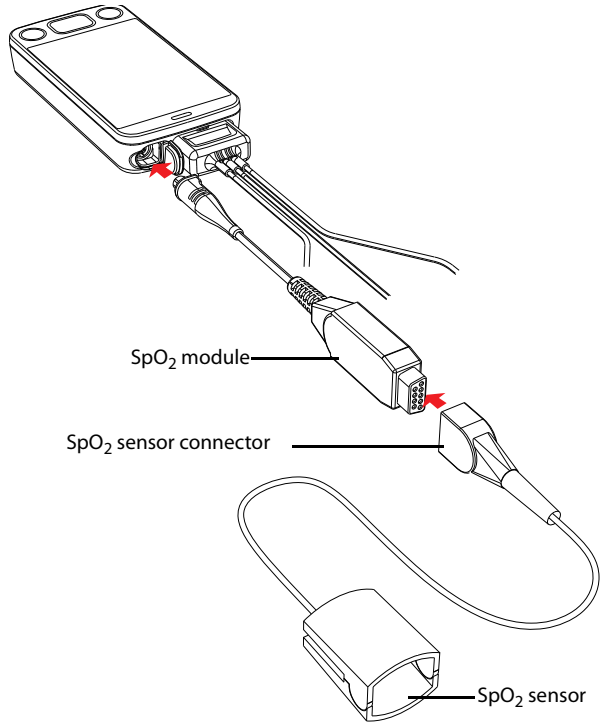

Connecting the Nonin SpO₂ module

9.5 Changing the SpO₂ Settings

You can change the SpO₂ settings from the SpO₂ menu.

9.5.1 Configuring the SpO₂ Setup

Enter the SpO₂ menu in either of the following ways:

- On the main screen, tap the SpO₂ digital area or Pleth waveform area to enter the **SpO₂** menu.
 - In the main menu, tap **Parameter Setup** → **SpO₂** to enter the **SpO₂** menu.
1. In the **Setup** section of the **SpO₂** menu, select the options described in the following table.

Options	Description	Settings*
Display PI (Masimo only)	Configures whether or not to show the perfusion index (PI) value in the digital area. The perfusion index allows clinicians to assess the pulse strength at the monitoring site for optimal sensor placement. PI gives the numerical value for the pulsatile portion of the measured signal caused by arterial pulsation. PI is an indicator of the pulsatile strength.	On, Off

* *The factory default settings are in bold.*

Options	Description	Settings*
<p>Sensitivity (Masimo only)</p>	<p>Selects the sensitivity mode depending upon signal quality and patient motion.</p> <p>High: This mode should be used for the sickest patients, where obtaining a reading is most difficult. High Sensitivity is designed to interpret and display data for even the weakest of signals. This mode is recommended during procedures and when clinician and patient contact is continuous.</p> <p>Normal: This mode provides the best combination of sensitivity and probe off detection performance. This mode is recommended for the majority of patients.</p> <p>APOD (Adaptive Probe Off Detection): This mode is the least sensitive in picking up a reading on patients with low perfusion but has the best detection for probe-off conditions. This mode is useful for patients that are at particular risk of the sensor becoming detached (pediatric, combative, etc.)</p>	<p>High, Normal, and APOD</p>
<p>Averaging (Masimo only)</p>	<p>The user-selectable averaging feature allows the clinician to select the desired level of visibility to subtle variations in the measured value. Depending on the patient acuity and area of care, shorter averaging times are sometimes preferred (sleep testing) over longer averaging times (telemetry) and vice-versa.</p> <p>8-second averaging is generally considered the most common averaging interval and recommended for most patients since it is short enough to provide visibility to subtle desaturations while also being long enough to minimize major changes in SpO₂ due to quick, transitory desaturations. Although averaging times greater than 10 seconds are more likely to reduce visibility to rapid, brief desaturations, this may be desirable in care areas where brief desaturations that do not require clinician intervention occur more often (such as NICU). It is also recommended that this be enabled as a "sticky" configuration so as to hold the setting after power cycles.</p>	<p>2-4 sec, 4-6 sec, 8 sec, 10 sec, 12 sec, 14 sec, 16 sec</p>
<p>Fast SAT (Masimo only)</p>	<p>Selects whether or not to enable FastSat. FastSat enables rapid tracking of arterial oxygen saturation changes.</p>	<p>On, Off</p>

* *The factory default settings are in bold.*

Options	Description	Settings*
Color	Selects the SpO ₂ waveform color.	16 colors The default color is cyan.

* The factory default settings are in bold.

2. Tap  to exit the **SpO₂** menu.

9.5.2 Configuring the SpO₂ Waveform

1. In the **Waveform** field of the **SpO2** menu, select the options described in the following table.

Options	Description	Settings*
Speed	Selects the SpO ₂ pleth waveform speed.	6.25 mm/s, 12.5 mm/s , 25 mm/s
Display SIQ (Masimo only)	Selects whether or nor to show the Signal Index Quality (SIQ) in the SpO ₂ waveform area. The SIQ wave indicates the confidence associated with the saturation measurement and timing of the pulse. Higher pulse is a better signal.	On , Off

* The factory default settings are in bold.

2. Tap  to exit the **SpO2** menu.

9.6 SpO₂ Measurement

9.6.1 Identifying SpO₂ Modules

To identify which SpO₂ module you are using, see the company logo on the SpO₂ module.

- Masimo SpO₂ module: white, with a logo of Masimo SET.
- Nonin SpO₂ module: blue, with a logo of Nonin.

9.6.2 Applying the Sensor

1. Select an appropriate sensor according to the module type, patient size, and weight.
2. Remove colored nail polish from the application site.
3. Apply the sensor to the patient.
4. Connect the sensor to the SpO₂ module and the SpO₂ module to the TD60/TM80.

The SpO₂ measurement displays when the TD60/TM80 detects that a sensor is connected to the patient.

WARNING

- **When equipped with Masimo SpO₂ module, use only Masimo SpO₂ sensors specified in this manual. Use of other SpO₂ sensors may cause improper oximeter performance.**
- **When equipped with Nonin SpO₂ module, use only Nonin SpO₂ sensors specified in this manual. Use of other SpO₂ sensors may cause improper oximeter performance.**
- **Do not disconnect the Nonin SpO₂ sensor connector from the Nonin SpO₂ module during defibrillation.**
- **If the sensor is too tight because the application site is too large or becomes too large due to edema, excessive pressure for prolonged periods may result in venous congestion distal from the application site, leading to interstitial edema and tissue ischemia.**

CAUTION

- **Many patients suffer from poor peripheral perfusion due to hypothermia, hypovolemia, severe vasoconstriction, reduced cardiac output, etc. These symptoms may cause a loss in vital sign readings.**
-

9.7 Understanding the SpO₂ Display

9.7.1 SpO₂ Digital Area

The SpO₂ digital area displays:

1. Parameter name
2. SpO₂ value
3. Perfusion indicator
4. Perfusion index (PI) label
5. Perfusion index value
6. SpO₂ unit of measure
7. Pulse rate (PR) label
8. PR measurement unit
9. PR value

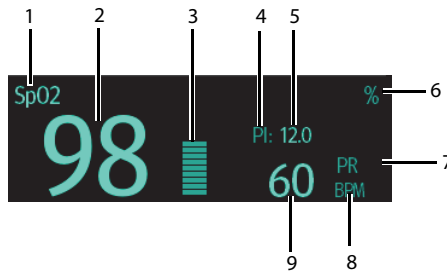

Masimo SpO₂ digital area (for portrait display)



Masimo SpO₂ digital area (for landscape display)



Nonin SpO₂ digital area

9.7.2 About the SpO₂ Digital Area

- The SpO₂ digital area displays in units of % with a resolution of 1%.
- The SpO₂ PR value displays in units of bpm with a resolution of 1 bpm.
- Displays Masimo PI resolution as 0.01 when the PI value is smaller than 10%.
- Displays Masimo PI resolution as 0.1 when the PI value is greater than or equal to 10%.
- If the SpO₂ measurement or PR is invalid, "--" displays in place of digits.

9.7.3 SpO₂ Waveform Area

The SpO₂ waveform area displays:

1. Signal Index Quality (SIQ)
2. Area name
3. Pleth waveform

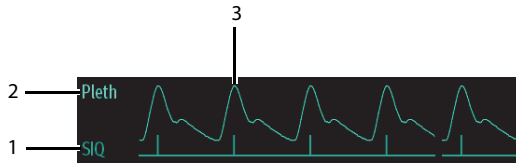

Masimo SpO₂ waveform area (SIQ enabled)



Nonin SpO₂ waveform area

9.7.4 About the SpO₂ Waveform Area

- Displays in the configured SpO₂ color.
- Provides scrolling, real-time waveform data.
- Scrolls the waveform in the configured sweep speed.
- Automatically scales the SpO₂ waveform data area to maximize the vertical height of the Pleth waveform for the data range.

If using Masimo SpO₂, the Signal Quality Index (SIQ) will display below the waveform if enabled.

9.8 Masimo Information



- **Masimo Patents**

This posting serves as notice under 35 U.S.C.§287(a). For a listing of Masimo patents applicable to this device and its accessories, please refer to <http://www.masimo.com/patents.htm>.

- **No Implied License**

Possession or purchase of this device does not convey any express or implied license to use the device with unauthorized sensors or cables which would, alone, or in combination with this device, fall within the scope of one or more of the patents relating to this device.

This page intentionally left blank.

10 **Monitoring NIBP (Optional)**

Introduction	10-2
Pairing the TD60/TM80 with the BP10	10-2
Unpairing the TD60/TM80 with the BP10	10-4
Screen Display after Pairing a TD60/TM80 with a BP10	10-5
Interactions after Pairing a TD60/TM80 with a BP10.....	10-7

10.1 Introduction

NIBP (non-invasive blood pressure) data is measured by BP10 using the oscillometric method. This measurement can be used for adult and pediatric patients over three years old. NIBP data is transferred from the BP10 to the TD60/TM80.

You can pair and unpair a TD60/TM80 with a BP10 via the Mindray Patient Area Network (MPAN) functionality.

Once a TD60/TM80 is paired successfully with a BP10, measured NIBP data and NIBP-related technical alarms will be displayed on the TD60/TM80 main screen. Besides, the TD60/TM80 allows you to perform some operations on the BP10.

For the functionalities and operations of the BP10, refer to **BP10 NIBP Module Operator's Manual (P/N 046-011008-00)**.

10.2 Pairing the TD60/TM80 with the BP10

10.2.1 Pairing Procedure

Before pairing the TD60/TM80 with a new BP10, first unpair the already connected BP10 by following steps in **10.3.1 Unpairing via the TD60/TM80**.

To pair a TD60/TM80 with a BP10, follow this procedure:

1. Press the MPAN key on the right panel of the BP10. The "Pairing..." message will display in the message area of the BP10.
2. Press  to enter the main menu of the TD60/TM80.
3. Tap **Wireless Modules**.
4. For the TM80, tap **MPAN**, and then select **Monitor/Sensor**.

For the TD60, switch on **MPAN**.

The TD60/TM80 starts searching the BP10 devices in the vicinity and displays the devices that can be connected under **Devices**. Make sure that the device you wish to connect appears in the list of devices. If not, repeat Steps 1 to 4.

5. In the list of devices, select your desired device and tap **Connect**. Once the device is connected successfully, the status will be changed from **Disconnect** to **Connected**.
6. Start an NIBP measurement from TD60/TM80 to verify that desired BP10 module is paired, and the NIBP measurement displayed on the BP10 are consistent with that displayed on the TD60/TM80.

WARNING



- **Before pairing a BP10 with a new TD60/TM80, unpair it with the current TD60/TM80 first.**
 - **Do not pair a TD60/TM80 with an undesired BP10. If a TD60/TM80 is paired with an undesired BP10, the patient category may be not applicable for the patient and the measured NIBP data may be incorrect.**
-
-

NOTE

- **Make sure that you have selected the correct BP10 to pair it with the TD60/TM80.**
 - **If you pair a TD60/TM80 with a BP10 when NIBP measurement mode is set to ABPM at BP10, the system responses after successful pairing are slightly different from that when the NIBP measurement mode is set to Manual, Auto, or Sequence. For the differences, see 10.2.2 System Responses after Successfully Pairing on page 10 - 3.**
-

10.2.2 System Responses after Successfully Pairing

Once a TD60/TM80 is paired successfully with a BP10, the following system responses occur:

- The  icon will be changed to  in the top-right corner of the TD60/TM80's screen. Besides, the  appears in the top-right corner of the BP10.
- The status of the BP10 which is paired successfully with the TD60/TM80 is displayed as **Connected**. Besides, the "Pairing Successful" displays in the BP10's message area for about 10 seconds.
- When NIBP measurement mode is set to **[ABPM]** at BP10 and the BP10 is paired successfully with the TD60/TM80, the wireless setup confirmation message "Select Yes to continue Patient in BP10. Select No to continue Patient in Telemetry." will display on the main screen of the TD60/TM80.
 - ◆ **[Yes]:** Patient-related settings comes from BP10 and ongoing NIBP measurement for current patient will not stop.
 - ◆ **[No]:** Patient-related settings at BP10 comes from the TD60/TM80. Besides, NIBP measurement for the patient monitored by BP10 will stop and the data history related to this patient will be cleared at BP10. When a BP10 in ABPM mode is not unpaired with a TD60/TM80 and needs to be paired with a new

TD60/TM80, you must select **[No]**. Otherwise, chaotic patient data may occur.

- ◆ If neither **[Yes]** nor **[No]** is selected, the wireless setup confirmation message will disappear in three minutes. Besides, the “Pairing failure” message will be displayed in the prompt message area of the TD60/TM80. The “MPAN Disconnected” message is displayed in the message area of the BP10. In this case, follow steps in **10.2** Pairing the TD60/TM80 with the BP10 on page 10 - 2 to pair the TD60/TM80 with the BP10 again.

- When NIBP measurement mode is set to **Manual**, **Auto**, or **Sequence** and the BP10 is paired successfully with the TD60/TM80, the wireless setup confirmation message “Select Yes to continue Patient in BP10. Select No to continue Patient in Telemetry.” will not be displayed. Patient-related settings from the TD60/TM80 will be transferred to the BP10. But NIBP-related settings displayed on the main screen of the TD60/TM80 will come from the BP10. The patient monitored by BP10 will be discharged automatically and the data history related to this patient will be cleared.

- Patient Category can be changed at the TD60/TM80 only.

A patient cannot be discharged from the BP10 and NIBP-related settings are grayed out at BP10. To discharge a patient from BP10, you need to unpair the BP10 from the TD60/TM80, refer to **10.3 Unpairing the TD60/TM80 with the BP10 on page 10 - 4**.

10.3 Unpairing the TD60/TM80 with the BP10

You can unpair the TD60/TM80 with the BP10 either via the TD60/TM80 or via the BP10.

10.3.1 Unpairing via the TD60/TM80

You can choose either of the two methods to unpair the TD60/TM80 with the BP10 via the TD60/TM80.

Option 1:

1. Press  to enter the main menu of the TD60/TM80.
2. Tap **Wireless Modules**.
3. Select the device you wish to disconnect from the TD60/TM80 from the devices list under **Devices** and tap **Disconnect**. The connected device is disconnected from the TD60/TM80.

Option 2:

For TD60, you can also follow this procedure to unpair it with the BP10.

1. Press the  key to enter the main menu of the TM80.
2. Tap **Wireless Modules**.
3. Disable **MPAN**.

For TM80, you can also follow this procedure to unpair it with the BP10.

1. Press the  key to enter the main menu of the TM80.
2. Tap **Wireless Modules**.
3. Tap **MPAN**.
4. Select **Off** or **Sensor**.

10.3.2 Unpairing via BP10



1. Press the MPAN key on the BP10.
2. Select **Yes** when the prompt message “Are you sure you want to close MPAN and unpair BP10?” appears.

CAUTION

- **Before moving a TD60/TM80 or BP10 to another area, unpair them first.**
 - **Before admitting a new patient at a BP10, you need to unpair it with a TD60/TM80 first.**
-
-

10.3.3 System Responses after Successfully Unpairing

When the TD60/TM80 is unpaired with the BP10 successfully:

- The status of the BP10 connected previously will be changed to **Disconnect** under **Devices** on the TM80.
- The  icon will be changed to  in the top-right corner of the TD60/TM80's screen and of the BP10.
- Measured NIBP values on the main screen of the TD60/TM80 is displayed as “---” indicating invalid values.

10.4 Screen Display after Pairing a TD60/TM80 with a BP10

When a TM80 is paired with a BP10 successfully, measured NIBP values will be displayed on the main screen of the TM80 as shown in the following figure.

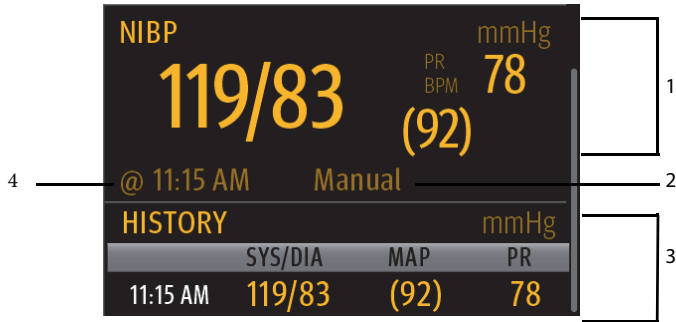

1. Current NIBP measurement result area
Displays NIBP real-time measurement results such as measured systolic pressure, diastolic pressure, and pulse rate.
2. NIBP measurement mode
There are four options: Manual, Auto, Seq., ABPM.
3. NIBP measurement history area
Displays NIBP measurement history information.
4. NIBP measurement time
Displays the time when NIBP measurement starts.

10.5 Interactions after Pairing a TD60/TM80 with a BP10

10.5.1 Overview of Interactions

Once a TD60/TM80 is paired successfully with a BP10, the interactions proceed as shown below.

Action	At the TM80	At the BP10
Start NIBP measurement	Yes	Yes
Stop NIBP measurement	Yes	Yes
Stop All NIBP measurements	Yes	Yes
NIBP STAT	Yes	Yes
Set initial pressure	Yes	No
Set NIBP measurement mode	Yes	No
Configure settings related to Auto measurement mode	Yes	No
Configure settings related to NIBP Sequence measurement mode	Yes	No
Set NIBP settings related to NIBP ABPM measurement mode	Yes	No
Set venipuncture	No	Yes
Set the cuff pressure for venipuncture	No	Yes

10.5.2 Operating the BP10 via the TD60/TM80

When the TD60/TM80 is paired successfully with the BP10, you can tap anywhere in the NIBP parameter area on the main screen of the TD60/TM80 to access the **NIBP** menu.

In the **Actions** section of the **NIBP** menu, you can:

- Tap **Start** to start NIBP measurement at the BP10.
- Tap **Stop** to stop an ongoing NIBP measurement at the BP10.
- Tap **NIBP STAT** to start the series measurement in continuous mode at the BP10.
- Tap **Stop All** to cancel the series measurement in Auto, Sequence, or ABPM mode at the BP10.

10.5.3 NIBP Operations at the TD60/TM80

In the **Setup** section of the **NIBP** menu at the TD60/TM80, you can:

- Tap **Mode** to set NIBP measurement mode to one of the following: Manual, Auto, Seq. ABPM.
- Tap **ABPM** to configure ABPM-related settings: Day, Night, Start, Interval.
- Tap **Auto** to set NIBP measurement interval to one of the following: 1 min, 2 min, 2.5 min, 3 min, 5 min, 10 min, 15 min, 20 min, 30 min, 1h, 1.5h, 2h, 3h, 4h, 8h.
- Tap **Seq.** to configure sequence-related settings: P1, P2, P3, P4, P5
- Tap **Initial Pressure** to set the initial cuff pressure.
- Tap **Color** to select your desired color in which NIBP measurement results will be displayed on the main screen of the TM80. 16 color options are available. Tap your desired color and this color will be displayed on the right of **Color**.

For detailed description of NIBP-related operations and settings, refer to **BP10 NIBP Module Operator's Manual (P/N 046-011008-00)**.

11

Configuring the TD60/TM80

Introduction	11-2
Entering the Maintenance menu	11-2

11.1 Introduction

This Maintenance menu at the TD60/TM80 provides access to the system settings such as location, device name, alarm settings, quick keys, screen lock, and password updates. Entering this menu **requires** a passcode.

11.2 Entering the Maintenance menu

1. In the main menu, tap **Maintenance**.
2. Input the maintenance passcode.
3. Tap **Accept** to enter the **Maintenance** menu.

11.3 Configuring the General Menu

Select **General** to configure the display auto off, language, location, notch filter, ECG lead labeling, SpO2 module, SpO2 tone, and enable or disable ECG calibration.

1. In the **Maintenance** menu, tap **General**.
The current setting displays to the right of the option.
2. Select the options described in the following table.

Options	Description	Settings*
Display Auto Off	Configures the time for display auto off.	1 min , 2 min, 5 min, 15 min 30 min, Off
Language	Configures the system language.	ENGLISH , FRENCH
Location	Changes the hospital and department names	N/A
Notch Filter	Configures the ECG Notch filter. This option is used to filter out AC line noise from the ECG waveform.	50 Hz, 60 Hz , Off The default is 50 Hz when the monitor is not configured for the US.
ECG Lead Labeling	Changes the ECG lead labeling.	AHA , IEC
Calibrate ECG	Enables or disables the ECG verification.	On, Off Refer to " Verifying the ECG at the TD60/TM80 " on page 16 - 5 for details.
SpO2 Module	Changes the SpO2 module.	Masimo , Nonin

* *The factory default settings are in bold.*

Options	Description	Settings*
SpO2 Tone	Configures the SpO2 tone.	Mode 1 , Mode 2
Resp	Displays Resp digital area and waveform area on the main screen.	On, Off This option is available only when your TD60/TM80 supports the Resp functionality.

* *The factory default settings are in bold.*

3. Tap  to exit the **General** menu.

NOTE

- **Mindray recommends the same SpO₂ tone mode be used for the device within a monitoring area.**



11.4 Configuring the Alarms Menu

Select **Alarms** to configure the alarm tone, reminder tone, reminder interval, minimum alarm volume, and technical alarm priority.

1. In the **Maintenance** menu, tap **Alarms**.
The current setting displays to the right of the option.
2. Select the options described in the following table.

Section & Options	Description	Settings*
Sounds		
Style	Allows an authorized user to set the alarm tone pattern.	ISO , Mode 1, Mode 2
Timeout		
Reminder Tone	Allows an authorized user to enable or disable the reminder tone. If the alarm tone is turned off, enabling this setting can issue a periodic reminder tone.	On, Off
Reminder Interval	Allows an authorized user to configure the intervals between the alarm tones.	1 min, 2 min, 3 min, 5 min , 10 min

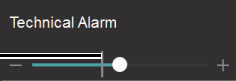
* *The factory default settings are in bold.*

Section & Options	Description	Settings*
Minimum Alarm Volume		
Technical	<p>Allows an authorized user to set the minimum technical alarm volume.</p> <p>The minimum technical alarm volume defines the minimum value you can set for the technical alarm volume.</p> <p>For example:</p> <p>If the minimum technical alarm volume is set to 5, the minimum value you can set for the technical alarm volume in the Audio Volume menu is 5 (as shown in the following figure).</p>  <p>If the minimum technical alarm volume is set to Off, and the technical alarm volume can be set to 0, the alarm sound is turned off and the  symbol appears on the screen.</p>	Off, 1, 2, 3, 4, 5, 6, 7, 8, 9, 10
Technical Alarm Priority		
ECG Lead Off	Allows an authorized user to configure the alarm level.	Low, Medium, High
SpO2 Sensor Off	Allows an authorized user to configure the alarm level.	Low, Medium, High

* *The factory default settings are in bold.*

- Tap  to exit the **Alarm** menu.

WARNING

- **When the technical alarm audio volume is set to alarm sound and the alarm sound is turned off, the TD60/TM80 will not enunciate technical alarms when they occur. Be careful when turning off the alarm volume.**
 - **Do not rely exclusively on the audible alarm system for monitoring. Adjustment of alarm volume to a low level may result in a hazard to the patient. Always keep the patient under close surveillance.**
-
-

11.5 Quick Keys Menu

11.5.1 Changing the Quick Keys

1. In the **Maintenance** menu, tap **Quick Keys**.
The **Quick Keys** configuration menu displays.

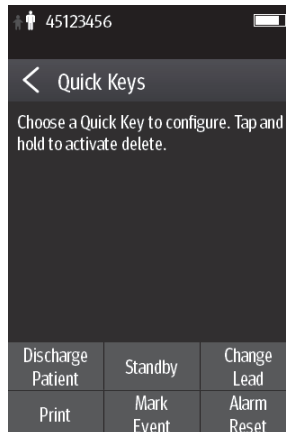

2. From the quick keys area at the bottom of the screen, tap a quick key you want to configure.
A list of option displays.

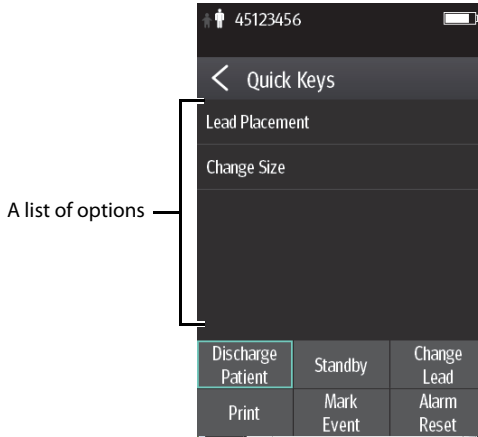

3. Tap the desired option from the list of options to configure the selected quick key.
4. Repeat steps 2 to 3 to configure other quick keys, if needed.
5. Tap  to exit the **Quick Keys** menu.

11.5.2 Deleting a Quick Key

1. From the quick keys area at the bottom of the **Quick Keys** menu, press and hold the desired quick key for two seconds, and then release it.
The quick key background turns to red and displays **Delete**.
2. Tap **Delete**.
The quick key is removed from the quick keys area, and the area displays **Not Used**.
3. Tap  to exit the **Quick Keys** menu.

11.6 Configuring the Network Menu (for TM80 only)

In the **Network** menu, you can configure the TM80 and connect it to the BeneVision Central Monitoring System via the wireless network.

1. In the **Maintenance** menu, tap **Network**.
2. Select the options described in the following table.

Options	Action	Description
IP Address Setup	Select to access the IP Setting menu.	Refer to Configuring IP Settings on Page 11-7 for details.
WLAN Setup	Select to access the WLAN Setting menu.	Refer to Configuring WLAN Settings on Page 11-8 for details.
Connect CMS	Select to access the Connect CMS menu.	
Wireless Setup	Select the desired wi-fi band.	Refer to on Page 11-10 for details.
EAP Certificate	Import desired certificates and delete certificates from the TM80.	Refer to EAP Certificate Management on Page 11-11 for details.

- Press  to return to the main screen.

NOTE

- **The design, installation, reconstruction and maintenance of the wireless network's distribution shall be performed by authorized service personnel of Mindray.**
- **If a wireless network is provided by a hospital, it needs to be confirmed by authorized service personnel of Mindray.**
- **The existence of obstacles (such as walls) will impact data transferring or possibly cause network interruption.**
-

11.6.1 Configuring IP Settings

The TM80 provides two ways to be assigned an IP address: Dynamic Host Configuration Protocol (DHCP) and Static IP address.

To configure IP settings:

- In the **Network** menu, tap **IP Address Setup**.
- Select the options described in the following table.

Options	Description	Settings*
DHCP	Allows an authorized user to select the way to get the IP address. When enabled, the IP address is automatically assigned.	On, Off
Following three options are only enabled when DHCP is set to Off.		
IP Address	Select to input the IP address.	Range: 1 to 255 Factory default: 192.168.0.100
Subnet Mask	Select to input the subnet mask.	Range: 1 to 255 Factory default: 255.255.255.0
IP Gateway	Select to input the IP gateway address.	Range: 1 to 255 Factory default: 192.168.0.254

* *The factory default settings are in bold.*

3. Tap **Confirm** to apply the settings and exit the **IP Address Setup** menu.

11.6.2 Configuring WLAN Settings

1. In the **Network** menu, tap **WLAN Setup**.
2. Select the options described in the following table.

Options	Description	Settings*
Network Name	Select to input the name for the desired wireless network.	N/A
Security Type	Configure the wireless network security type. If WPA2-PSK is selected, you need to configure Network Password . If WPA2 EAP or WPA2 CCKM is selected, you need to configure Network Password and additional items such as EAP Method and Authentication . You also need to import the desired certificate into the TM80 before you can select a certificate. For how to manage certificates, see EAP Certificate Management on Page 11-11 .	WPA2-PSK , WPA2 EAP, WPA2 CCKM

* *The factory default settings are in bold.*

3. Tap **Confirm** to apply the settings and exit the **WLAN Setup** menu.

NOTE

- **We recommend that the WPA2-PSK or WPA2 CCKM security mode be used when the TM80 is in use. It provides a strong method of security when used with rotating strong passwords. Besides, it can provide optimal mobility and connectivity performance.**
- **WPA2 EAP may be used, but should be carefully considered. As WPA2 EAP takes longer time to roam, network offline events may occur during roaming.**

11.6.3 Configuring Central Monitoring System Connection

You can connect a TM80 to a central monitoring system in unicast or multicast mode.

11.6.3.1 Connecting a Central Monitoring System in Multicast Mode

1. In the **Network** menu, tap **Connect CMS**.
2. Tap **Connection Mode**.
3. Select **Multicast**.
4. Configure the desired options.

Options	Description	Settings*
Multicast Address	Select to input the multicast address.	Range: 1 to 255 Factory default: 225.0.0.8
Port	It is a public port to communicate with the Central Monitoring System	6678, grayed and unchangeable
	This option is not configurable.	
Multicast TTL	Select to input the Multicast Time to Live (TTL).	Range: 1 to 255 Factory default: 1
QOS	Configure the quality of service mode for the wireless network.	High , Normal

* *The factory default settings are in bold.*

5. Tap **Confirm** to apply the settings and exit the **Connect CMS** menu.

11.6.3.2 Connecting a Central Monitoring System in Unicast Mode

1. In the **Network** menu, tap **Connect CMS**.
2. Tap **Connection Mode**.
3. Select **Unicast**.
4. Configure the desired options.

Options	Description	Settings*
Edit CMS	Configure the name and IP of the CMS you want to connect.	/
Select CMS	Select the CMS you want to connect.	/
QOS	Configure the quality of service mode for the wireless network.	High , Normal

* *The factory default settings are in bold.*

Tap **Confirm** to apply the settings and exit the **Connect CMS** menu.

11.6.4 Selecting a Central Monitoring System

When you connect a TM80 to a CMS in unicast mode, you can select a CMS by one of the following ways:

- Select **Select CMS** from the **Connect CMS** menu. For details, refer to **Connecting a Central Monitoring System in Unicast Mode** on **Page 11-10**.
- Press  to enter the main menu → in the **Central Monitoring System** section, tap **Select CMS** → select the desired CMS.

11.6.5 Selecting WiFi Bands and Channels

The TM80 supports both 2.4G and 5G WiFi bands.

To select a WiFi band rate and channels, follow this procedure:

1. In the **Network** menu, tap **Wireless Setup**.
2. Tap **WiFi Band**.
3. Select **2.4G** or **5G** according to the band you are using. 5G is recommended, if available. Because there is much more wireless interference in the 2.4GHz band.
4. Tap **BGN Channels** or **AN Channels** according to the WiFi band selected.
 - ◆ When **2.4G** is selected, tap **BGN Channels**.
 - ◆ When **5G** is selected, tap **AN Channels**.

5. Select the desired channels.

NOTE

- **BGN Channels and AN Channels default to be blank. Channels need to be selected to improve roaming performance.**
-

11.6.6 EAP Certificate Management

You can import up to 10 certificates from a USB drive or delete certificates from the TM80.

The TM80 only supports certificates in PEM format. If you need to use certificates in other formats, you need to convert the certificates before importing them into the TM80. The openssl tool (version 1.0.2c or later) is recommended for the conversion, and you can get the setup file on internet conveniently.

11.6.6.1 Importing Certificates

Up to 10 certificates can be imported from a USB drive. Only authorized personnel can import certificates.

Required tools:

- An empty USB drive (FAT data format and at least 256 MB space)
- One USB upgrade cable (P/N: 009-005409-00)
- One computer used to prepare USB drive tools
- One power module with USB port (output voltage: 5 V, output current not less than 1 A)

Follow this procedure to import certificates:

1. Insert a USB drive to the USB port of your computer
2. Create the folder named "Cert" in the USB drive.
3. Copy the desired certificates to the "Cert" folder.
4. Remove the battery from the battery compartment and find the MicroUSB socket inside the battery compartment. Connect the MicroUSB end of the USB upgrade cable to the MicroUSB socket, insert the prepared upgrade USB drive on the USB female connector of the upgrade cable, and connect the USB male connector of the upgrade cable to the USB power adapter as shown below.

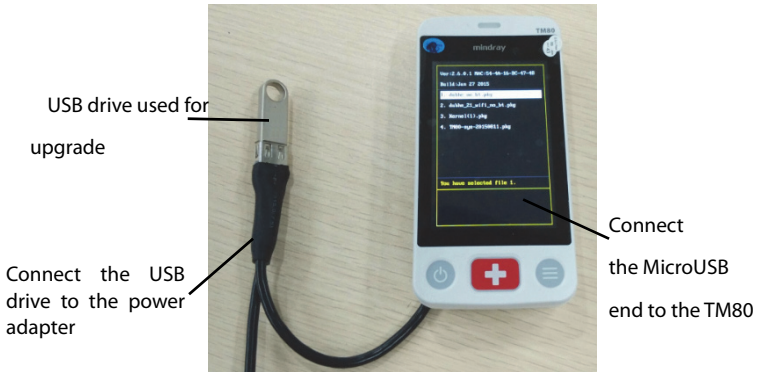

5. Power on the TM80.
6. Press  to enter the main menu → tap **Maintenance** → enter the required password → tap **Network** → tap **EAP Certificate** → tap **USB** and then select the desired certificate.
7. Tap **Import**.

11.6.6.2 Deleting Certificates

1. Press  to enter the main menu → tap **Maintenance** → enter the required password → tap **Network** → tap **EAP Certificate**.
2. Tap **Local**.
3. Select the desired certificate.
4. Tap **Delete**.

11.7 Configuring the Defaults Menu

The **Defaults** menu allows an authorized user to manage the system configurations.

1. In the **Maintenance** menu, tap **Defaults**.
2. Select the options described in the following table.

Options	Description
Save Departmental Defaults	Allows an authorized user to save the current device settings for the selected patient category.
Export Device Settings	Copies the current settings to the external device.
Import Device Settings	Copies the settings from the external device to the TD60/TM80 unit. Refer to "Transferring a Configuration" on page 11 - 13 for details.
Restore Factory Defaults	Allows an authorized user to reestablish the original database power up settings to factory default values.

* *The factory default settings are in bold.*

3. Tap  to exit the **Defaults** menu.

11.7.1 Transferring a Configuration

You can copy some configurations of one TD60/TM80 to another TD60/TM80 via the MPAN functionality.

The following takes the example of transferring the configurations from TM80 A to TM80 B.

To transfer the configuration from the TM80 A to TM80 B:

1. In the **Maintenance** menu of TM80 B, select **Defaults** → **Import Device Settings** to enter the settings import mode.
2. In the **Maintenance** menu of the TM80 A, select **Defaults** → **Export Device Settings** to enter the **Export Device Settings** menu.

The external device (TM80 B in this example) found is listed in the **Export Device Settings** menu.

3. Select the desired external device (TM80 B in this example) by tapping the check box.
4. Tap **Export** to start exporting the TM80A's configurations.

The "Downloading device settings" message will be shortly displayed on the TM80 B's screen.

WARNING

- **Do not power off the devices during the download process.**
 - **The  symbol displays at the top of the screen while transferring a configuration.**
-
-

- If an import is successful, the “Download complete.” message will be displayed on the TM80 B’s screen. The screen returns to the **Defaults** menu in 10 seconds. The “Complete” message will be displayed on the TM80 A’s screen.
- If the import fails, the “Import attempt failed.” message will be displayed on the TM80 B’s screen. The “Failure” message will be displayed in the prompt message list of TM80 A’s screen.

You have two options when a failure occurs:

- ◆ To stop the import from TM80 A, tap  at TM80 B to exit the **Import Device Settings**.
- ◆ To retry the import from the TD60 A, tap the external devices where the “**Failure**” message is displayed and tap the **Retry** button to restart the transfer.

You may need to repeat the retry operation several times until the transfer is successful.

11.8 Screen Lock Menu

11.8.1 Understanding the Screen Lock Mode

There are two modes of being able to lock the screen to assist in preventing unauthorized use. Each mode allows the user access to certain features of the product without entering a passcode. When the correct passcode is entered, all features are available.

- Locked Mode Features:
 - ◆ Main screen and main menu are not accessible without passcode entry.
 - ◆ The message area is still viewable.
 - ◆ Hardkeys are enabled.
- View Only Features:
 - ◆ Upon powering up, the main screen will be displayed after the new patient choice is made.
 - ◆ Main Screen is accessible without passcode entry.

- ◆ The **System Info** menu is accessible by tapping the battery symbol on the main screen.
- ◆ The **Lead Placement** menu is accessible by tapping an "ECG Sensor Off" message in the alarm area.
- ◆ Ability to change display orientation.
- ◆ Hardkeys are enabled.

11.8.2 Setting the Screen Lock

The initial enabling of screen lock mode requires a passcode to be entered immediately as follows:

1. In the **Maintenance** menu, tap **Screen Lock** to select a screen lock mode.
2. Enter a new passcode for the screen lock.

After the passcode is entered, the screen exits the passcode setup menu. The selected lock mode displays to the right of **Screen Lock**.

11.8.3 Changing the Current Screen Lock Passcode

1. In the **Maintenance** menu, tap **Screen Lock**.
2. Tap **Screen Lock Passcode**.
3. Input the current password.
4. Input and verify the new password

11.8.4 Changing the Screen Lock Mode

Follow this procedure to change the screen lock:

1. In the **Maintenance** menu, tap **Screen Lock** to choose a screen lock mode.
2. Select your desired screen lock mode and then enter a passcode.

11.9 Changing the Passwords

1. In the **Maintenance** menu, tap **Edit Passwords**.
 - ◆ Tap **Maintenance Password** and follow the on-screen instructions to change the maintenance password.
 - ◆ Tap **Service Password** and follow the on-screen instructions to change the service password.

2. Tap the  icon to exit the **Edit Passwords** menu.

11.10 Changing the Device Name

1. In the **Maintenance** menu, tap **Device Name**.
2. Use the on-screen keyboard to input the device name.
3. Tap **Accept** to save the setting and exit the **Device Name** menu.

NOTE

- **Do not set the same device name for the TD60s.**

11.11 Setting CMS Disconnect Alarm (For the TM80 Only)

In the **Maintenance** menu, you can set whether to enable **CMS Disconnect Alarm**. This option is enabled by default.

- When it is enabled, after the TM80 is disconnected from the CMS:
 - ◆ The TM80's display is turned on automatically.
 - ◆ The TM80 issues a low-pitched beep, its alarm light indicator flashes in cyan, and the "No CMS" message is displayed in the prompt message area of the TM80.
- When it is disabled, after the TM80 is disconnected from the CMS:
 - ◆ The TM80's display is not turned on automatically. But you can turn on the display manually.
 - ◆ The TM80 does not issue a low-pitched beep and its alarm light indicator does not flash. But the "No CMS" message is still displayed in the prompt message area of the TM80.

WARNING

- **When CMS Disconnect Alarm is disabled, the medical staff should pay more attention to the patient's status and check the TM80's network connection status at the CMS. When the offline alarm is displayed on the CMS, medical staff should check the patient's status immediately.**

11.12 Demo Mode

Allows an authorized user to choose a demonstration mode for in-servicing staff or testing product features.

11.13 Service Menu

Allows an authorized user access to the passcode protected Service menu.

This page intentionally left blank.

12

Monitoring with the TMS60/TM80 at the CMS

Introduction	12-2
Monitoring at the CMS (Version Earlier than 03.00)	12-2
Monitoring at the CMS (Version 03.00 or Above)	12-34

12.1 Introduction

The chapter describes detailed configurations and data displayed on the CMS once the TMS60 telemetry monitoring system and the TM80 are connected to the CMS.

The TMS60 telemetry monitoring system can be connected to the CMS whose version is earlier than 03.00 and to the CMS whose version is 03.00 or above. But the Resp and NIBP functionalities for the TMS60 telemetry monitoring system are only supported by the CMS whose version is 03.00 or above.

The TM80 can be connected to the CMS whose version is 03.00 or above only.

12.2 Monitoring at the CMS (Version Earlier than 03.00)

Once the TMS60 telemetry monitoring system is connected to the CMS whose version is earlier than 03.00, you can view physiological alarms for ECG and SpO₂ parameters, change settings in the **ECG** tab and **SpO₂** tab of the **Parameter Setup** menu.

12.2.1 Physiological Alarms

At the CMS, you can view and change the physiological alarm limits and alarm levels in the **Alarm Setup** menu. The **Alarm Setup** menu has three tabs:

- **Parameter Alarm Settings:** view and change the parameter alarm limits, alarm levels and alarm responses.
- **Arrhythmia Alarms:** view and change the arrhythmia alarms levels, and alarm responses.
- **Arrh. Threshold Setup:** view and change the arrhythmia threshold settings for some arrhythmia alarms.

For details about the **Alarm Setup** menu, See the *BeneVision Central Monitoring System Operator's Manual (P/N 046-007960-00)*.

WARNING

- **Be aware that the devices in your care area may each have different alarm settings to suit different patients. Always check that the alarm settings are appropriate for your patient before you start monitoring.**
 - **A potential hazard can exist if different alarm presets are used for the same or similar equipment in any single area, such as an intensive care unit or cardiac operating room.**
 - **Make sure that the alarm limits settings are appropriate for your patient before monitoring.**
 - **When monitoring patients that are not continuously attended by a clinical operator, properly configure the alarm system and adjust alarm settings as per the patient's condition.**
 - **Setting alarm limits to extreme values may cause the alarm system to become ineffective. For example, high oxygen levels may predispose a premature infant to retrolental fibroplasia. If this is a consideration do NOT set the high alarm limit to 100%, which is equivalent to switching the alarm off.**
 - **If you switch off all arrhythmia alarms, the CMS cannot give any arrhythmia alarms. Always keep the patient under close surveillance.**
-
-

12.2.1.1 Factory Default Parameter Alarm Settings

The following table lists the factory default alarm settings for all parameters.

Parameters	Activati on State	Alarm High Limit	Alarm Low Limit	Alarm Priority	Alarm Response		
					Record on Alarm	Print on Alarm	Paging Switch
HR/PR Unit of mea- sure: bpm Invalid data: "_"	On, Off	For adult: (Low limit + 2) to 300 Default: 120 For pediatric: (Low limit + 2) to 350) Default: 160	For adult: 15 to (high limit - 2) Default: 50 For pediat- ric: 15 to (high limit - 2) Default: 75	High, Med	On, Off	On, Off	On, Off
ST Single Unit of mea- sure: mV Invalid data: "_"	On, Off	For adult and pediatric: (Low limit + 0.2) to 2.00 Default: 0.1	For adult and pediat- ric: -2.00 to (high limit - 0.2) Default: -0.1	High, Med , Low			
ST Dual Unit of mea- sure: mV Invalid data: "_"							
QTc Unit of mea- sure: ms Invalid data: "_"		For adult: 200 to 800 Default: 500 For pediatric: 200 to 800 Default: 480	For adult and pediat- ric: None				
Δ QTc* Unit of mea- sure: ms Invalid data: "_"		For adult and pediatric: 30 to 200 Default: 60	For adult and pediat- ric: None				

Notes:

Δ QTc is only available for Advanced ECG Algorithm.

The factory default settings are in bold.

Parameters	Activati on State	Alarm High Limit	Alarm Low Limit	Alarm Priority	Alarm Response		
					Record on Alarm	Print on Alarm	Paging Switch
SpO ₂ Unit of mea- sure: % Invalid data: "..."	On, Off	For adult and pediatric: (Low limit + 2) to 100 Default: 100	For adult and pediat- ric: 0 to (high limit - 2) Default: 90	High, Med	On, Off	On, Off	On, Off
SpO ₂ Desat Unit of mea- sure: % Invalid data: "..."	On, Off	For adult and pediatric: None	For adult and pediat- ric: 0 to 100 Default: 80	High			

Notes:

ΔQTC is only available for Advanced ECG Algorithm.

The factory default settings are in bold.

NOTE

- **The SpO₂ Desat alarm limit is restricted such that the alarm limit can not be higher than the SpO₂ low limit.**

12.2.1.2 Factory Default Arrhythmia Alarm Settings

■ Advanced ECG Algorithm

Name	Activation State	Alarm Priority	Alarm Response			
			Record on Alarm	Print on Alarm	Paging Switch	
Asystole	On, Off	High	On, Off	On, Off	On, Off	
VFib/VTac						
VTac						
Vent. Brady						
Extreme Tachy						
Extreme Brady						
PVCs/min	On, Off	High, Med , Low, Message				
R on T						
Run PVCs		High, Med, Low , Message				
Couplet		High, Med, Low, Message				
PVC						
Vent. Rhythm	On, Off	High, Med , Low, Message				
Bigeminy	On, Off					
Trigeminy						
Tachy						
Brady						
Pacer Not Pac- ing						High, Med, Low, Message
Pacer Not Cap- ture						
<p><i>Notes</i> The factory default settings are in bold.</p>						

Name	Activation State	Alarm Priority	Alarm Response		
			Record on Alarm	Print on Alarm	Paging Switch
Missed Beat	On, Off	High, Med, Low, Message	On, Off	On, Off	On, Off
Multif. PVC		High, Med , Low, Message			
Nonsus. Vtac					
Pause		High, Med, Low, Message			
AFib		High, Med, Low, Message			
Irr.Rhythm		Low, Message			
Pauses/min		High, Med , Low, Message			
<p>Notes</p> <p>The factory default settings are in bold.</p>					

NOTE

- **When Paced is set to Yes, the Missed Beat (MIS) alarm is reported as the Pacer Not Capture (PNC) or Pacer Not Pacing (PNP) alarm.**

■ Standard ECG Algorithm

Parameters	Activation State	Alarm Priority	Alarm Outputs					
			Record on Alarm	Print on Alarm	Paging Switch			
Asystole	On, Off	High	On, Off	On, Off	On, Off			
VFib								
VTac								
Extreme Tachy								
Extreme Brady								
PVCs/min	On, Off	High, Med , Low, Message						
R on T								
Run PVCs		High, Med, Low , Message						
Couplet		High, Med, Low, Mes- sage						
Vent. Rhythm	On, Off	High, Med , Low, Message						
Bigeminy	On, Off							
Trigeminy								
Tachy								
Brady								
Pacer Not Pac- ing		High, Med, Low, Mes- sage						
Pacer Not Cap- ture								
Multif. PVC								
Pause								
Irr.Rhythm								
Pauses/min								
<p>Note</p> <p>The factory default settings are in bold.</p>								

NOTE

- **The priority of lethal arrhythmia alarms is always high. It is unchangeable.**

In addition, the activation state of some arrhythmias can be set as a whole with the following buttons that are at the bottom of the **Arrhythmia Alarms** tab.

Button	Description
Lethals Only	Sets the lethal arrhythmia alarms to on and all non-lethal arrhythmia alarms to off.
All Alarms On	Sets all arrhythmia alarms to on.
All Alarms Off	Sets all arrhythmia alarms to off.

12.2.1.3 Arrhythmia Threshold Settings

When an arrhythmia violates its threshold, an alarm is triggered. For the Standard ECG algorithm, the setting of asystole delay is related to arrhythmia relearn. When HR is less than 30 bpm, it is recommended to set asystole delay to 10 s.

■ Advanced ECG Algorithm

Arrh. event	Range or Option	Default	Step	Unit of measure
PVCs High	1 to 100	10	1	minute
Pauses/min	1 to 15	8	1	None
Asys. Delay	3 to 10	4	1	second
Tachy High	60 to 300	Adult: 120 Pediatric: 160	5	bpm
Brady Low	15 to 120	Adult: 50 Pediatric: 75	5	bpm
Extreme Tachy	60 to 300	Adult: 160 Pediatric: 180	5	bpm
Extreme Brady	15 to 120	Adult: 35 Pediatric: 50	5	bpm
Multif. PVC's Window	3 to 31	15	1	/min

Arrh. event	Range or Option	Default	Step	Unit of measure
VTac Rate	100 to 200	130	5	bpm
VTac PVC	3 to 99	6	1	beat
Pause Time	1.5, 2, and 2.5	2	None	second
VBrd Rate	15 to 60	40	5	bpm
VBrd PVCs	3 to 99	5	1	beat

■ Standard ECG Algorithm

Arrh. event	Range or Option	Default	Step	Unit
PVCs High	1 to 100	10	1	minute
Pauses/min	1 to 15	8	1	None
Asys. Delay	2 to 10	4	1	seconds
VTac Rate	100 to 200	130	5	bpm
VTac PVC	3 to 12	6	1	beat
Extreme Tachy	Adult: 100 to 300 Pediatric: 160 to 300	Adult: 160 Pediatric: 180	5	bpm
Extreme Brady	Adult: 15 to 60 Pediatric: 15 to 80	Adult: 35 Pediatric: 50	5	bpm
Multif. PVC's Window	3 to 31	15	1	/min
Tachy High	Adult: 100 to 300 Pediatric: 160 to 300	Adult: 120 Pediatric: 160	5	bpm
Brady Low	Adult: 15 to 60 Pediatric: 15 to 80	Adult: 50 Pediatric: 75	5	bpm
Pause Threshold RR	1.2, 1.3, 1.4, 1.5, 1.6, 1.7, 1.8, 1.9, and 2.0	2.0	None	s

12.2.2 ECG Monitoring

At the CMS, you can view and change the heart rate (HR), QT, ST, and arrhythmia settings in the **ECG** tab of the **Parameter Setup** menu.

For details about the **Parameter Setup** menu, See the ***BeneVision Central Monitoring System Operator's Manual***.

At the CMS, you can view and change the ECG settings in the **ECG** tab. To enter the ECG tab, follow this procedure:

1. Select the ECG digital area or waveform area to enter the **Parameter Setup** menu.
2. Select the **ECG** tab.

12.2.2.1 HR Settings

The following table lists the HR settings in the **HR** section of the **ECG** tab.

Options or Buttons	Description	Settings*
HR Activation State	Configures whether or not to enable the HR alarm.	See "Factory Default Parameter Alarm Settings" on page 12 - 4 for details.
HR Alarm Priority	Configures the HR alarm levels.	
HR High Limit (bpm)	Configures the HR high alarm limit.	
HR Low Limit (bpm)	Configures the HR low alarm limit.	
Pacer Rate (bpm) (only Standard ECG Algorithm)	When some pacemaker pulses are difficult to reject, the pulses are counted as a QRS complex and could result in an incorrect HR and failure to detect some arrhythmias. Configures the pacemaker rate, the system can calculate HR and detect arrhythmias more accurately.	40 to 100 The default is 60 .
	The option is unavailable when Paced is set to No at the TD60. For details about the paced status, See " Setting the Paced Status " on page 7 - 12.	
Sweep Speed	Configures the ECG wave speed.	6.25 mm/s, 12.5 mm/s, 25 mm/s , 50 mm/s
HR Source	Configures the HR source.	ECG , SpO ₂ , Auto, Both
HR Record on Alarm	Select whether or not to activate the option to direct the CMS to send the HR alarm data to the configured recorder.	On, Off
Waveform Setup	Select to display the Waveform Setup menu.	See " Waveform Setup " on page 12 - 12 for details.

* *The factory default settings are in bold.*

Options or Buttons	Description	Settings*
Other Settings	Select to display the Other Settings menu.	See " Other Settings " on page 12 - 14 for details.

* *The factory default settings are in bold.*

12.2.2.2 Waveform Setup

The ECG leads waveforms displayed in the waveform area are defined as the displayed lead.

The CMS uses information from two leads to detect beats and to compute HR. These two leads are referred to as the primary and secondary leads. In addition, for Standard ECG Algorithm, information from an additional lead (analysis lead) is made use of to classify the beats (normal, abnormal etc). The user can select any of the available leads (depending on whether a 3 or 5 lead cable is used) as primary, secondary or other analysis leads.

For best results, the following guidelines should be used:

- The QRS complex should be tall, narrow and preferably either completely above or below the baseline. If at all possible, avoid selecting a lead where the QRS complex is biphasic.
- The P-waves and T-waves should be small compared to the QRS. They should be less than about 0.2 mV.

Changing the Setting for Analysis Leads and Displayed Leads

The default system setting for the analysis leads and displayed leads is **On**, which means that the analysis leads are consistent with the displayed leads. You can change the default setting as following steps, if necessary.

1. At the CMS, select **Admin Setup** → input the password → select **OK**.
2. In the **Admin Setup** menu, select the **Telemetry** tab.
3. On the left side of the **Telemetry** tab, select **Analysis Lead Setup**.
The corresponding setting displays to the right of **Telemetry**.
4. Set **Consistent with Displayed Lead** to **On** or **Off**.
 - ◆ **On**: the analysis lead is the same as the displayed lead.
 - ◆ **Off**: the analysis lead is different from the displayed lead.

Changing ECG Wave Settings

In the **Waveform Setup** menu, you can configure the displayed leads and analysis leads as desired. The lead settings are dependent on the setting of **Analysis Lead Setup**.

- When **Analysis Lead Setup** is set to **On**, the ECG waveform configurations are applied for the displayed leads and analysis leads.

Follow the steps below to configure the ECG waveform setting:

1. In the **HR** section of the **ECG** tab, select **Waveform Setup**.

The **Waveform Setup** menu displays.

2. Select the options described in the following table to configure the ECG waveforms.

Options	Description	Settings*	
		Lead	Waveform size
ECG 1	Select the desired ECG lead and set the corresponding gain for ECG 1.	I, II , III, aVR, aVL, aVF, V	× 0.125, × 0.25, × 0.5, × 1 , × 2, × 4
ECG 2	Select the desired ECG lead and set the corresponding gain for ECG 2.	I, II, III, aVR, aVL, aVF, V	× 0.125, × 0.25, × 0.5, × 1 , × 2, × 4
ECG 3	Select the desired ECG lead and set the corresponding gain for ECG 3.	I, II, III, aVR, aVL, aVF, V	× 0.125, × 0.25, × 0.5, × 1 , × 2, and × 4

* *The factory default settings are in bold.*

3. Select **Exit** to save the settings and close the **Waveform Setup** menu.

- When **Analysis Lead Setup** is set to **Off**, the displayed leads and analysis leads should be configured respectively.

Follow the steps below to configure the ECG waveform setting:

1. In the **HR** section of the **ECG** tab, select **Waveform Setup**.

The **Waveform Setup** menu displays.

2. Select the options described in the following table to configure the ECG wave forms.

Options	Description	Settings*	
		Lead	Waveform size
ECG 1	Select the desired ECG lead and set the corresponding gain for ECG 1 to display in the waveform area.	I, II , III, aVR, aVL, aVF, V	× 0.125, × 0.25, × 0.5, × 1 , × 2, × 4
ECG 2	Select the desired ECG lead and set the corresponding gain for ECG 2 to display in the waveform area.	I , II, III, aVR, aVL, aVF, V	× 0.125, × 0.25, × 0.5, × 1 , × 2, × 4
ECG 3	Select the desired ECG lead and set the corresponding gain for ECG 3 to display in the waveform area.	I, II, III, aVR, aVL, aVF, V	× 0.125, × 0.25, × 0.5, × 1 , × 2, × 4
Primary lead	Configures the primary analysis lead.	I , II , III, aVR, aVL, aVF, V	None
Secondary lead	Configures the secondary analysis lead.	I , II , III, aVR, aVL, aVF, V	None
Classification lead (only for Mortara ECG algorithm)	Configures other analysis lead.	I , II , III, aVR, aVL, aVF, V	None

* *The factory default settings are in bold.*

3. Select **Exit** to save the settings and close the **Analysis Lead Setup** menu.

Other Settings

In the **HR** section of the **ECG** tab, select **Other Settings**. The **Other Settings** menu displays.

The following table lists all settings in the **Other Settings** menu.

Options	Description	Settings*
Paced	The option is unavailable at the CMS. The paced status can be set at the TD60 only. Refer to " Setting the Paced Status " on page 7 - 12 for details.	

* *The factory default settings are in bold.*

Options	Description	Settings*
Pacer Reject	Configures whether or not to reject the pace pulses. ■ On : the pace pulses are not counted as extra QRS complexes. ■ Off : the pace pulses are not rejected.	On, Off
This Pacer Reject option is only available when Paced is set to Yes at the TD60.		
Filter	Configures the ECG filter in all operating modes. ■ Monitor : use under normal measurement conditions. ■ ST : use when the ST monitoring is applied.	Monitor, ST

* *The factory default settings are in bold.*

12.2.2.3 ECG Display

The ECG digital area displays:

1. Parameter label
2. HR value
3. High HR alarm limit
4. Low HR alarm limit
5. Pauses threshold
6. Pauses per minute value
7. Pauses per minute label
8. PVCs threshold
9. PVCs per minute value
10. PVCs per minute label

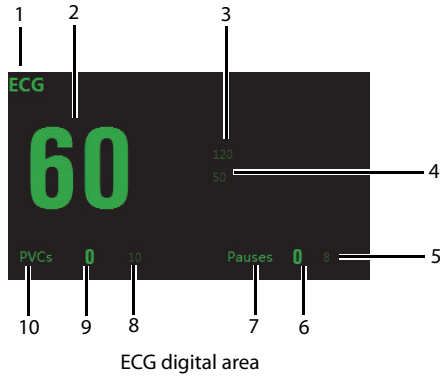

NOTE

- If the Activation State for HR, PVCs or Pauses alarm is set to Off, the  symbol displays to the right of corresponding parameter.

ECG Waveform Area

The ECG waveform area displays:

1. ECG Lead
2. ECG waveform size
3. ECG filter setting
4. Notch filter setting
5. ECG waveform
6. ECG scale

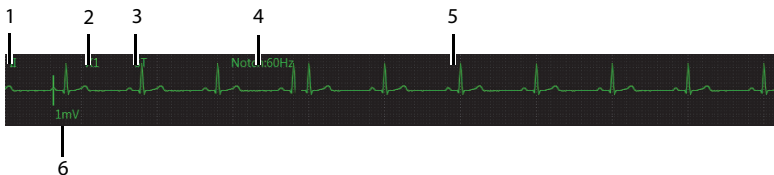

ECG waveform area

12.2.3 QT Monitoring

A normal ECG waveform (as shown in the following figure) typically includes a sharp and well defined QRS complexes with consistent spacing between R waves, and an ECG baseline that is free of noise and artifact.

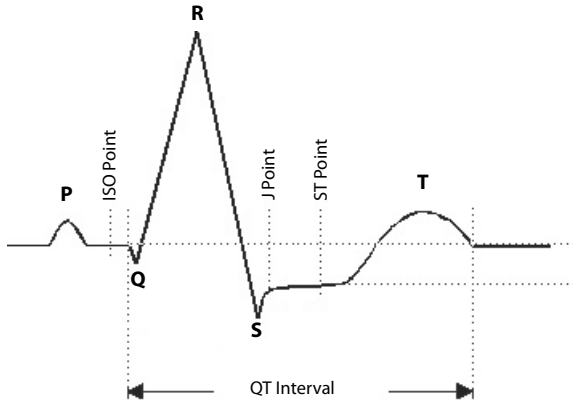

A normal ECG waveform (for QT monitoring)

The QT interval in an ECG lead is the time interval from the onset of the earliest deflection in the QRS complex to the end of the T wave. QT monitoring can assist in the detection of prolonged QT interval syndrome.

12.2.3.1 Measurement Limitations

QT/QTc values are calculated with 3-leadwire or 5-leadwire ECG cables.

12.2.3.2 QT Settings

The following table lists the QT settings in the **QT Analysis** section of the **ECG** tab.

Options	Description	Settings*
QT Analysis	Enables or disables QT analysis.	On, Off

* *The factory default settings are in bold.*

Options	Description	Settings*
QTc Formula	Configures the QTc formula used.	Bazett: $QTc = QT \times \left(\frac{QTHR}{60}\right)^{1/2}$ Fridericia: $QTc = QT \times \left(\frac{QTHR}{60}\right)^{1/3}$ Framingham: $QTc = QT + 154 \times \left(1 - \frac{60}{QTHR}\right)$ Hodges: $QTc = QT + 1.75 \times (QTHR - 60)$
QT Alarm Setup	Configures the QT alarms.	<ul style="list-style-type: none"> ■ For details about the QT alarms limits, See "Factory Default Parameter Alarm Settings" on page 12 - 4 for details. ■ For details about the QT alarms responses, See "Factory Default Parameter Alarm Settings" on page 12 - 4 for details.
	<ul style="list-style-type: none"> ■ For Mindray algorithm, you can configure the QTc and ΔQTc alarm. ■ For Standard ECG algorithm, you can configure the QTc alarms. 	
QT View	Select to display the QT View menu.	See " QT View Menu (Only for Advanced ECG Algorithm) " on page 12 - 18 for details.
	This button is only available for the Advanced ECG Algorithm.	

* The factory default settings are in bold.

12.2.3.3 QT View Menu (Only for Advanced ECG Algorithm)

In the **QT View** menu, you can view a snapshot of the real-time wave and to verify that the QT algorithm detects correct Q and T points.

The **QT View** menu displays, as shown in the following figure:

- ◆ The current waveform and parameter values display in green.
- ◆ The template waveform and parameter values display in yellow.
- ◆ The Q and T points are marked with a vertical line.
- ◆ The Δ QTc value is equal to the current QTc value minus the template QTc value.



QT View menu

Follow the steps below to configure items in the **QT View** menu:

1. In the **QT Analysis** section of the **ECG** tab, set **QT Analysis** to **On**.
2. Select **QT View**.
3. Configure the desired items.

Buttons	Description	Settings*
Lead	Select the desired lead to display on the QT View menu screen.	II, I, III, aVR, aVL, aVF, V
Set as Ref.	Replaces the template waveform and QT/QTc values with the current waveform and QT/QTc values.	None
	The QT template updated time displays at the bottom of the screen.	
Print	Prints the template and current waveforms, and QT/QTc values for all leads.	None
Exit	Closes the QT View Menu.	None

* *The factory default settings are in bold.*

12.2.3.4 QT Display

When **QT Analysis** is enabled, the QT digital area displays:

1. Parameter label
2. QTc value
3. High QTc alarm limit

4. Activation State Off symbol for QTc alarm
5. Δ QTc label
6. Δ QTc value
7. High Δ QTc alarm limit
8. Activation State Off icon for Δ QTc alarm
9. QT value
10. QT label
11. QTc label
12. QT-HR label
13. QT-HR value

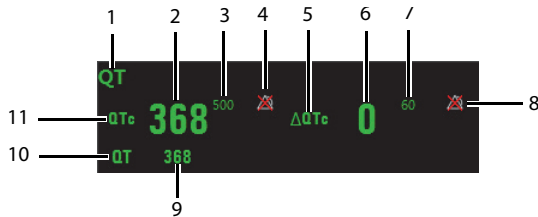

Example QT digital area (for Advanced ECG Algorithm)

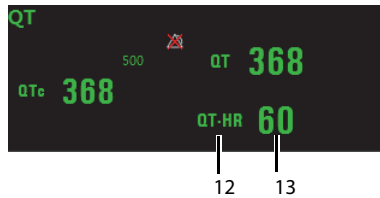

Example QT digital area (for Standard ECG Algorithm)

CAUTION

- **Updating QTc reference affects Δ QTc value and alarm.**

12.2.4 ST Monitoring

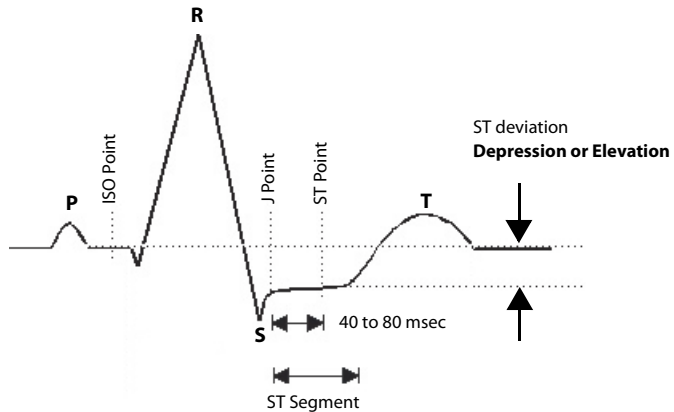

A normal ECG waveform (for ST monitoring)

The ST segment of an ECG waveform (as shown in the above figure) represents the period from the end of ventricular de-polarization, to the beginning of ventricular re-polarization, or the end of the QRS complex (the J point) and the beginning of the T-wave. ST Segment analysis is used to monitor the oxygen supply and the viability of the heart muscle.

ST deviation is the vertical distance between the isoelectric (ISO) point level and signal level at ST point.

The ISO point is located between the end of the P-wave and the onset of the QRS complex. The ISO point provides the baseline for this measurement.

The ST point is a fixed distance from the J point at the end of the QRS complex. The ST point can be configured to 40, 60, or 80 milliseconds past the J-point, independent of the heart rate. By default, the ST point is positioned as follows:

- At 80 milliseconds for heart rates less than or equal to 120 beats per minute
- At 60 milliseconds for heart rates greater than 120 beats per minute

All available ECG leads are analyzed to measure deviations in the ST segment.

Selecting leads that contain the least amount of baseline flutter will improve measurement accuracy, but accurate ST deviation measurement is dependent on the correct location of the ISO and ST points.

- ST segment analysis calculates ST segment elevations and depressions for individual leads and then displays them as numerics in the ST digital area.
- A positive value indicates ST segment elevation; a negative value indicates ST segment depression.

WARNING

- **The ST algorithm has been tested for accuracy of the ST segment data. The significance of the ST segment changes need to be determined by a clinician.**
-
-

12.2.4.1 Measurement Limitations

- ST values may be affected by such factors as some drugs or metabolic and conduction disturbances.
- Since ST is often calculated with a fixed delay from the J point, changes in heart rate may affect ST.
- The ST algorithm has been tested for accuracy of the ST segment data. The significance of the ST segment changes needs to be determined by a physician.

12.2.4.2 ST Settings

The following table lists the ST settings in the **ST Analysis** section of the **ECG** tab.

Options or Buttons	Description	Settings*
ST Analysis	Enables or disables ST analysis.	On, Off
	If ST Analysis is set to On , the Filter option from the Other Settings menu is automatically set to ST .	
Display ST Segments	Select whether or not to display the ST segments in the waveform area.	On, Off
ST Alarm Setup	Configures the ST alarm settings.	<ul style="list-style-type: none"> ■ For details about the ST alarms limits, See "Factory Default Parameter Alarm Settings" on page 12 - 4 for details. ■ For details about the ST alarms responses, See "Factory Default Parameter Alarm Settings" on page 12 - 4 for details.
Define ST Point	Select to display the Define ST Point menu.	See " Adjusting ST Measurement Points " on page 12 - 23 for details.
	This button is only available when ST Analysis is set to On .	

* *The factory default settings are in bold.*

12.2.4.3 Adjusting ST Measurement Points

The ISO and ST points need to be adjusted when you start monitoring and if the patient's heart rate or ECG morphology changes significantly. Exceptional QRS complexes are not considered for ST-segment analysis.

WARNING

- **Always make sure that the ST measurement points are appropriate for your patient.**

To adjust ST measurement points, follow this procedure.

1. In the **ST Analysis** section of the **ECG** tab, select **Define ST Point**.

The **Define ST Point** menu displays, as shown in the following figure.

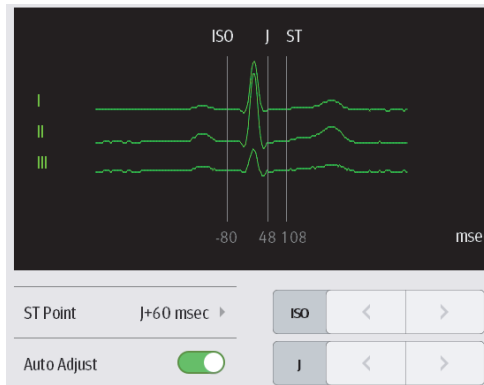

Define ST point menu

2. Adjust the parameter using the buttons described in the following table.

Buttons	Description	Settings*
Lead	Select the desired ECG lead.	I, II, III, aVR, aVL, aVF, V
ST (ms)	Based on the ms setting selected, moves the ST point further or closer to the J point in the ST template.	J+40, J+60 , J+80, J+60/80

* *The factory default settings are in bold.*

Buttons	Description	Settings*
ISO/J	Selecting Auto fixes the ISO and J/ST points. Selecting Manual allows the clinician to manually adjust ISO and J/ST points.	Auto , Manual
ISO left arrow	If ISO/J is set to manual, the button adjusts the ISO reference line to the left.	
ISO right arrow	If ISO/J is set to manual, the button adjusts the ISO reference line to the right.	
J left arrow	If ISO/J is set to manual, the button adjusts the J reference line to the left.	
J right arrow	If ISO/J is set to manual, the button adjusts the J reference line to the right.	

* The factory default settings are in bold.

3. Select the **OK** or **Cancel** button.
 - ◆ The **OK** button saves the settings and closes the menu.
 - ◆ The **Cancel** button closes the menu without saving the settings.

12.2.4.4 ST Display

When **ST Analysis** is enabled, the ST digital area displays:

1. Parameter label
2. ST alarm off symbol
3. ST values: a positive value indicates ST segment elevation, and a negative value indicates ST segment depression.
4. Units of measure
5. Lead identifier

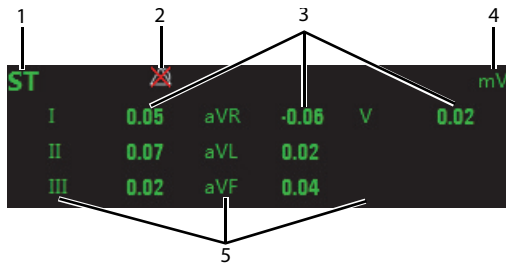

Example 5-lead ST digital area

12.2.4.5 ST Segment Display

When **Display ST Segments** is enabled, the ST segments display in the waveform area:

1. Lead identifier
2. ST markers (ISO, J/ST)
3. ST value
4. ECG scale



3-lead ST segment

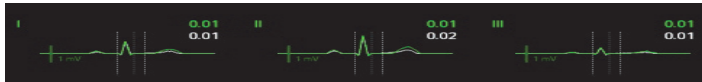

5-lead ST segments

12.2.5 Arrhythmia Monitoring

WARNING

- **The arrhythmia analysis program is intended to detect ventricular arrhythmias. It is not designed to detect atrial or supraventricular arrhythmias. It may incorrectly identify the presence or absence of an arrhythmia. Therefore, a physician must analyze the arrhythmia information with other clinical findings.**
- **Heart-rate reading may be affected by cardiac arrhythmias. Do not rely entirely on heart rate alarms when monitoring patients with arrhythmia. Always keep these patients under close surveillance.**
- **Atrial fibrillation (Afib) detection function is not intended for pediatric patients.**

12.2.5.1 Measurement Limitations

- Since the arrhythmia detection algorithm sensitivity and specificity is less than 100%, sometimes there may be some false arrhythmias detected and also some true arrhythmia events may not be detected. This is especially true when the signal is noisy.
- The ECG size and QRS width settings affect arrhythmia detection and heart rate calculation sensitivity.
- If QRS amplitude is low, the monitor might not be able to calculate HR and false asystole may occur.
- At the algorithm learning phase, arrhythmia detection may not be available. Therefore, closely monitor the patient's condition during the learning phase after the learning phase to allow the algorithm to reach optimal detection performance.

12.2.5.2 Understanding the Arrhythmia Events

- Advanced ECG Algorithm

Arrhythmia message	Description	Category
Asystole	No QRS detected within the set time threshold in absence of ventricular fibrillation or chaotic signal.	Lethal arrhythmia
VFib/VTac	A fibrillatory wave for 6 consecutive seconds. A dominant rhythm of adjacent Vs and a HR > the V-Tac HR limit.	
VTac	The consecutive PVCs \geq Vtac PVCs limit, and the HR \geq the Vtac rate limit.	
Vent. Brady	The consecutive PVCs \geq the Vbrd threshold and the ventricular HR < the Vbrd Rate threshold.	
Extreme Tachy	The heart rate is equal to or greater than the extreme tachycardia limit.	
Extreme Brady	The heart rate is equal to or less than the extreme bradycardia limit.	

Arrhythmia message	Description	Category
PVCs/min	PVCs/min exceeds high limit.	Nonlethal arrhythmia
R on T	R on T detected in normal heartbeats.	
Run PVCs	More than 2 consecutive PVCs.	
Couplet	Paired PVCs detected in normal heartbeats.	
PVC	One PVC detected in normal heartbeats.	
Vent. Rhythm	The consecutive PVCs \geq the Vbrd PVCs limit, and the HR \geq Vbrd Rate limit but $<$ the Vtac Rate limit.	
Bigeminy	A dominant rhythm of N, V, N, V, N, V.	
Trigeminy	A dominant rhythm of N, N, V, N, N, V, N, V.	
Tachy	The average heart rate is equal to or greater than the tachycardia limit.	
Brady	The average heart rate is equal to or less than the bradycardia limit.	
Pacer Not Pacing	No pace pulse detected for 1.75 x average R-to-R intervals following a QRS complex (for paced patients only).	
Pacer Not Capture	No QRS complex detected for 300 milliseconds following a pace pulse (for paced patients only).	
Missed Beat	No beat detected for 1.75 x average R-R interval for HR < 120 , or No beat for 1 second with HR > 120 (for non-paced patients only), or No beat detected for more than the set pause threshold.	
Multif. PVC	Multiform PVCs detected in Multif. PVC's Window (which is adjustable).	
Nonsus. Vtac	The consecutive PVCs $<$ the Vtac PVCs limit but > 2 , and HR \geq the Vtac Rate limit.	
Pause	No QRS detected within the set time threshold of pause.	
AFib	Continuously detect that the RR intervals of normal sinus beats irregular and no P wave of normal sinus beats.	
Irr. Rhythm	Consistently irregular rhythm.	
Pauses/min	The number of pauses detected per minute.	

■ Standard ECG Algorithm

Arrhythmia message	Description	Category
Asystole	No QRS complex detected within the set time threshold (in absence of ventricular fibrillation or chaotic signals).	Lethal arrhythmia
VFib	Ventricular fibrillation occurs and persists for 6 seconds.	
VTac	Ventricular HR is greater or equal to the preset threshold and the number of consecutive PVCs is greater than the preset threshold.	
Extreme Tachy	The heart rate is equal to or greater than the extreme tachycardia limit.	
Extreme Brady	The heart rate is equal to or less than the extreme bradycardia limit.	
PVCs/min	PVCs/min exceeds high limit.	Nonlethal arrhythmia
R on T	R on T is detected.	
Run PVCs	More than 2 consecutive PVCs.	
Couplet	Paired PVCs are detected.	
Vent. Rhythm	Ventricular HR is less than the preset threshold and the number of PVCs is greater than or equal to 3.	
Bigeminy	A dominant rhythm of N, V,N, V, N, V.	
Trigeminy	A dominant rhythm of N, N, V,N, N, V, N, N, V.	
Tachy	The HR is greater than the set tachycardia high limit.	
Brady	The HR is less than the set bradycardia low limit.	
Pacer Not Pacing	No pace pulse detected for (60×1000/pace rate +90) milliseconds following a QRS complex or a pacer pulse (for paced patients only).	
Pacer Not Capture	No QRS complex detected for 300 milliseconds following a pace pulse (for paced patients only).	
Multif. PVC	More than 2 PVCs of different forms occur in the predefined search window (3-31).	
Pause	No beat detected for 1.75x average R-R interval for HR <120, or No beat for 1 second with HR >120 (for non-paced patients only), or No beat detected for more than the set pause threshold.	
Irr. Rhythm	Consistently irregular rhythm	
Pauses/min	The number of pauses detected per minute.	

12.2.5.3 Arrhythmia Settings

The following table lists the arrhythmia settings in the **Arrhythmia Analysis** section of the **ECG** tab.

Options or Buttons	Description	Settings*
Arrhythmia Alarms	Configures the arrhythmia alarm settings.	See " Factory Default Arrhythmia Alarm Settings " on page 12 - 6 for details.
Relearn	Enables an arrhythmia relearning.	See " Relearning " on page 12 - 29 for details.
QRS Threshold Settings	Configures the QRS threshold.	See " Configuring the QRS Threshold " on page 12 - 30 for details.

12.2.5.4 Relearning

A relearn can be done for arrhythmia, ST analysis, or for both simultaneously.

NOTE

- **ST Analysis must be turned on before it will relearn.**

The TD60 initiates the learning process for ST or Arrhythmia analysis after any of the following:

- TD60 power-up
- Return to normal monitoring from the Standby mode
- Enabling ST or Arrhythmia analysis
- The lead has been changed in ECG 1 waveform (3 lead only)
- Patient size changes
- Selecting the **Relearn** button in the **Arrhythmia Analysis** section

Selecting the the **Relearn** button in the **Arrhythmia Analysis** section is recommended after one or more of the following:

- ECG electrodes have been repositioned
- Eight hours have passed since the last relearn
- Significant changes occurred to the patient QRS complex
- Significant changes occurred to the patient ECG rhythm

- A clinician has observed clinically questionable arrhythmia calls
- “Learning” occurred during a Leads Off condition

CAUTION

- **Initiate ECG relearning only during periods of normal rhythm and when the ECG signal is relatively noise-free. If ECG learning takes place during ventricular rhythm, the ectopics may be incorrectly learned as the normal QRS complex. This may result in missed detection of subsequent events of V-Tach and V-Fib.**

12.2.5.5 Configuring the QRS Threshold

The minimum detection threshold is approximately 0.16 mV. In case the P waves are very tall, one might consider moving the minimum QRS detection threshold up to be above the level of the P waves, so events like ventricular standstill are not missed.

Two horizontal lines (one below and one above the baseline) appear on the screen. These represent the current minimum detection threshold on the positive and negative sides of the baseline so manual adjustment for both positive and negative going QRS's can be made. Using the commands provided, move the minimum detection threshold up or down to ensure it is above the level of the P waves but below the peak of the R-wave. Since the P-wave height could vary a little from beat to beat, do not set the horizontal line representing the minimum detection threshold at or barely above the level of the peak of the P wave. Ensure that it is at least one or two millimeters above the peak of the P wave but below the peak of the R-wave.



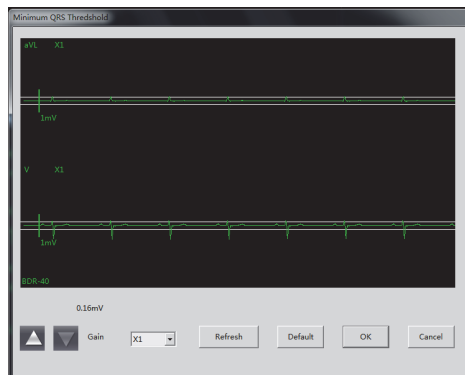

1. In the **Arrhythmia Analysis** section of the **ECG** tab, select **Minimum QRS Threshold**.

The **Minimum QRS Threshold** menu displays, as shown in the following figure.



Minimum QRS Threshold menu

The current waveform displays the data of previous eight seconds. Use the buttons described in the following table as desired.

Buttons	Description	Settings*
Gain	Select the desired ECG waveform size.	X1, X2, X4
Refresh	Displays the real-time waveform.	
Default	Automatically sets the default threshold: 0.16 mV.	
 or 	<p>Manually adjust the minimum QRS detection threshold.</p> <p>Select the  button to move the threshold line above the P wave, or select the  button to move the threshold line down closer to the P wave.</p>	

* *The factory default settings are in bold.*

2. Select the **OK** or **Cancel** button.
 - ◆ Once the threshold is in the desired position, select the **OK** button to save the settings and close the menu.
 - ◆ To quit adjusting the threshold, select the **Cancel** button to close the menu without saving the settings.

12.2.6 SpO₂ Monitoring

At the CMS, you can view and change the SpO₂ settings in the **SpO₂** tab of the **Parameter Setup** menu.

To enter the **SpO₂** tab, follow this procedure:

1. Select the SpO₂ digital area or waveform area to enter the **Parameter Setup** menu.
2. Select the **SpO₂** tab.

12.2.7 Measurement Limitations

See "Measurement Limitations" on page 9 - 3 for details.

12.2.8 SpO₂ Settings

The following table lists the SpO₂ settings in the **SpO₂** tab.

Options	Description	Settings*
Activation State	Configures whether or not to enable the SpO ₂ alarm.	On, Off
Alarm Priority	Configures the SpO ₂ alarm levels.	High, Med
Record on Alarm	Selects whether or not to activate the recorder when an SpO ₂ alarm is triggered.	On, Off
Sweep Speed	Configures the SpO ₂ waveform sweep speed.	6.25 mm/s, 12.5 mm/s, 25.0 mm/s , 50.0 mm/s
SpO ₂ Desat Limit Activation State	Configures whether or not to enable the SpO ₂ Desat alarm.	On, Off
Sensitivity (Masimo only)	The option is not configurable. The option setting is synchronous with the setting at the TD60. See "Configuring the SpO ₂ Setup" on page 9 - 7.	
SpO ₂ High Limit (%)	Configures the SpO ₂ high alarm limit.	(Low limit + 1) to 100 The default is 100 .
SpO ₂ Low Limit (%)	Configures the SpO ₂ low alarm limit.	0 to (high limit - 1) The default is 90 .
PR High Limit (bpm)	Configures the PR high alarm limit.	(Low limit + 2) to 300 The default for adult is 120 . The default for pediatric is 160 .
PR Low Limit (bpm)	Configures the PR low alarm limit.	18 to (high limit - 2) The default for adult is 50 . The default for pediatric is 75 .
SpO ₂ Desat Limit (%)	Configures the SpO ₂ Desat low limit.	0 to 100 The default is 80 .
Averaging (Masimo only)	The option is not configurable. The option setting is synchronous with the setting at the TD60. See "Configuring the SpO ₂ Setup" on page 9 - 7 for details.	

* *The factory default settings are in bold.*

12.2.9 SpO₂ Display

12.2.9.1 SpO₂ Digital Area

The SpO₂ digital area displays:

1. Parameter label
2. High SpO₂ alarm limit

3. PR label
4. PR value
5. High PR alarm limit
6. SpO₂ unit of measure
7. Low PR alarm limit
8. Masimo perfusion index value
9. PI label
10. Low SpO₂ alarm limit
11. SpO₂ value

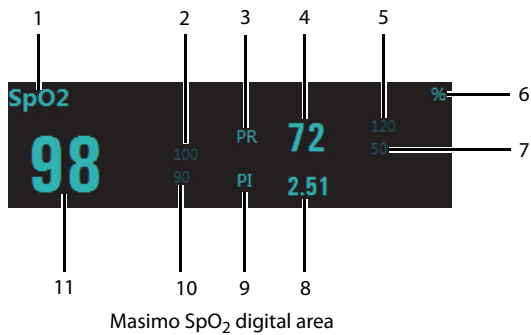

NOTE

- **When HR Source of the ECG tab is set to Both, the PR value displays on the SpO₂ digital area.**

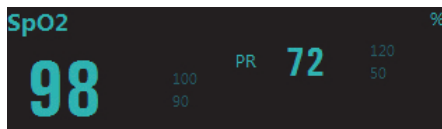

Nonin SpO₂ digital area

12.2.9.2 SpO₂ Waveform Area

The SpO₂ waveform area displays:

1. Parameter label
2. Pleth waveform

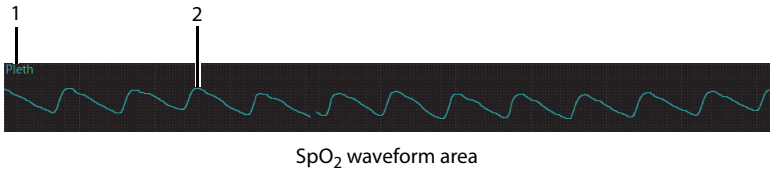

12.3 Monitoring at the CMS (Version 03.00 or Above)

Once the TMS60 telemetry monitoring system or the TM80 is connected to the CMS whose version is 03.00 or above, you can view physiological alarms for ECG, Resp, SpO₂, and NIBP parameters, change parameter settings and perform related operations.

12.3.1 Physiological Alarms

At the CMS, you can view and change the physiological alarm limits and alarm levels in the **Alarm Setup** menu. For details on how enter the **Alarm Setup** menu, see the *BeneVision Central Monitoring System Operator's Manual (P/N 046-010879-00)*.

12.3.1.1 Factory Default Parameter Alarm Settings

The following table lists the factory default alarm settings for all parameters.

Parameters	Activati on State	Alarm High Limit	Alarm Low Limit	Alarm Priority	Alarm Outputs
HR/PR Unit of mea- sure: bpm Invalid data: "..."	On, Off	For adult: (Low limit + 2) to 300 Default: 120 For pediatric: (Low limit + 2) to 350) Default: 160	For adult: 15 to (high limit - 2) Default: 50 For pediatri- c: 15 to (high limit - 2) Default: 75	High, Med	On, Off
ST Single Unit of mea- sure: mV Invalid data: "..."	On, Off	For adult and pediatric: (Low limit + 0.2) to 2.00 Default: 0.1	For adult and pediatri- c: -2.00 to (high limit – 0.2) Default: -0.1	High, Med, Low	
ST Dual Unit of mea- sure: mV Invalid data: "..."					
QTc Unit of mea- sure: ms Invalid data: "..."		For adult: 200 to 800 Default: 500 For pediatric: 200 to 800 Default: 480	For adult and pediatri- c: None		
Δ QTc* Unit of mea- sure: ms Invalid data: "..."		For adult and pediatric: 30 to 200 Default: 60	For adult and pediatri- c: None		
RR Unit of mea- sure: rpm Invalid data: "..."		On, Off	For adult and pediatric: 10 to 100 Default: 30	For adult and pediatri- c: 0 to 55 Default: 8	

Notes:

Δ QTc is only available for Advanced ECG Algorithm.

The factory default settings are in bold.

Parameters	Activati on State	Alarm High Limit	Alarm Low Limit	Alarm Priority	Alarm Outputs
SpO ₂ Unit of mea- sure: % Invalid data: "..."	On, Off	For adult and pediatric: (Low limit + 2) to 100 Default: 100	For adult and pediatri- c: 0 to (high limit - 2) Default: 90	High, Med	On, Off
SpO ₂ Desat Unit of mea- sure: % Invalid data: "..."		For adult and pediatric: None	For adult and pediatri- c: 0 to 100 Default: 80	High	
NIBP-S Unit of mea- sure: mmHg Invalid data: "..."		For adult: (Low limit + 5) to 270 Default: 160	For adult: 40 to (high limit - 5) Default: 90	High, Med	
NIBP-D Unit of mea- sure: mmHg Invalid data: "..."		For adult: (Low limit + 5) to 210 Default: 90	For adult: 10 to (high limit - 5) Default: 50		
NIBP-M Unit of mea- sure: mmHg Invalid data: "..."		For adult: (Low limit + 5) to 230 Default: 110	For adult: 20 to (high limit - 5) Default: 60		

Notes:

ΔQTC is only available for Advanced ECG Algorithm.

The factory default settings are in bold.

NOTE

- **The SpO₂ Desat alarm limit is restricted such that the alarm limit can not be higher than the SpO₂ low limit.**

12.3.1.2 Factory Default Arrhythmia Alarm Settings

The CMS (Version 03.00 or above) provides the advanced ECG algorithm for both the TM80 telemetry monitor and the TMS60 telemetry monitoring system, but only provides the standard ECG algorithm for the TMS60 telemetry monitoring system.

- Advanced ECG Algorithm (for both the TM80 and TMS60)

Name	Activation State	Alarm Priority	Alarm Outputs
Asystole	On, Off	High	On, Off
V-Fib/V-Tac			
V-Tac			
Vent Brady			
Extreme Tachy			
Extreme Brady			
PVCs/min	On, Off	High, Med , Low, Prompt	
R on T			
Run PVCs		High, Med, Low , Prompt	
Couplet		High, Med, Low, Prompt	
PVC			
Vent Rhythm	On, Off	High, Med , Low, Prompt	
Bigeminy	On, Off		
Trigeminy			
Tachy			
Brady			
Pacer Not Pacing			
Pacer Not Capture			
<p>Notes</p> <p><i>The factory default settings are in bold.</i></p>			

Name	Activation State	Alarm Priority	Alarm Outputs
Missed Beats	On, Off	High, Med, Low, Prompt	On, Off
Multiform PVC		High, Med , Low, Prompt	
Nonsus V-Tac			
Pause		High, Med, Low , Prompt	
A-Fib		High, Med, Low, Prompt	
Irr Rhythm		Low, Prompt	
Pauses/min		High, Med , Low, Message	
<p>Notes</p> <p><i>The factory default settings are in bold.</i></p>			

NOTE

- **When Paced is set to Yes, the Missed Beat (MIS) alarm is reported as the Pacer Not Capture (PNC) or Pacer Not Pacing (PNP) alarm.**

- Standard ECG Algorithm (for the TMS60 Only)

Parameters	Activation State	Alarm Priority	Alarm Outputs
Asystole	On, Off	High	On, Off
V-Fib			
V-Tac			
Extreme Tachy			
Extreme Brady			
PVCs/min	On, Off	High, Med , Low, Prompt	
R on T		High, Med, Low , Prompt	
Run PVCs			
Couplet			
Vent Rhythm	On, Off	High, Med , Low, Prompt	
Bigeminy	On, Off	High, Med, Low, Prompt	
Trigeminy			
Tachy			
Brady			
Pacer Not Pacing			
Pacer Not Capture			
Multiform PVC		High, Med, Low, Prompt	
Pause			
Irr Rhythm			
Pauses/min			
<i>Note</i> The factory default settings are in bold.			

NOTE

- **The priority of lethal arrhythmia alarms is always high. It is unchangeable.**

In addition, the activation state of some arrhythmias can be set as a whole with the following buttons that are at the bottom of the **Arrhythmia Alarms** tab.

Button	Description
Lethals Only	Sets the lethal arrhythmia alarms to on and all non-lethal arrhythmia alarms to off.
All On	Sets all arrhythmia alarms to on.
All Off	Sets all arrhythmia alarms to off.

12.3.1.3 Arrhythmia Threshold Settings

When an arrhythmia violates its threshold, an alarm is triggered. For the Standard ECG algorithm, the setting of asystole delay is related to arrhythmia relearn. When HR is less than 30 bpm, it is recommended to set asystole delay to 10 s.

- Advanced ECG Algorithm (for both the TM80 and TMS60)

Arrh. event	Range or Option	Default	Step	Unit of measure
PVCs /min	1 to 100	10	1	minute
Pauses/min	1 to 15	8	1	None
Asystole Delay	3 to 10	4	1	second
Tachy(HRHigh)	60 to 300	Adult: 120 Pediatric: 160	5	bpm
Brady(HR Low)	Adult: 15 to 115 Pediatric: 15 to 120	Adult: 50 Pediatric: 75	5	bpm
Extreme Tachy	60 to 300	Adult: 160 Pediatric: 180	5	bpm
Extreme Brady	Adult: 15 to 115 Pediatric: 15 to 120	Adult: 35 Pediatric: 50	5	bpm
Multif PVC'Window	3 to 31	15	1	beat
V-Tac Rate	100 to 200	130	5	bpm
V-Tac PVC	3 to 99	6	1	beat
Pause Threshold	1.5, 2, and 2.5	2	0.5	second
V Brady Rate	15 to 60	40	5	bpm

Arrh. event	Range or Option	Default	Step	Unit of measure
V Brady PVCs	3 to 99	5	1	beat

■ Standard ECG Algorithm (for TMS60 only)

Arrh. event	Range or Option	Default	Step	Unit
PVCs High	1 to 100	10	1	minute
Pauses/min	1 to 15	8	1	None
Asystole Delay	2 to 10	4	1	seconds
V-Tac Rate	100 to 200	130	5	bpm
V-Tac PVC	3 to 12	6	1	beat
Extreme Tachy	Adult: 100 to 300 Pediatric: 160 to 300	Adult: 160 Pediatric: 180	5	bpm
Extreme Brady	Adult: 15 to 60 Pediatric: 15 to 80	Adult: 35 Pediatric: 50	5	bpm
Multif PVC Window	3 to 31	15	1	/min
Tachy High	Adult: 100 to 300 Pediatric: 160 to 300	Adult: 120 Pediatric: 160	5	bpm
Brady Low	Adult: 15 to 60 Pediatric: 15 to 80	Adult: 50 Pediatric: 75	5	bpm
Pause Threshold RR	1.2, 1.3, 1.4, 1.5, 1.6, 1.7, 1.8, 1.9, and 2.0	2.0	None	s

12.3.2 ECG Monitoring

At the CMS, you can view and change the ECG settings in the **ECG** tab. To enter the **ECG** tab, follow this procedure:

1. Select the ECG digital area or waveform area to enter the **ECG** menu on the ViewBed screen of the CMS.
2. Select the **ECG** tab.

12.3.2.1 Setting ECG Alarm Properties

To set ECG alarm properties, follow this procedure:

1. From the **ECG** tab, select the **Alarm** section.
2. Set the desired alarm properties.

For the default alarm properties, See **“Factory Default Parameter Alarm Settings” on page 12-4.**

12.3.2.2 Changing ECG Wave Settings

To change ECG waveform related settings, follow this procedure:

1. From the **ECG** tab, select the **Setup** section.
2. Set the desired items.

Options or Buttons	Description	Default Setting
ECG 1	Select the desired ECG lead and set the corresponding gain for ECG 1. 6-lead is available for the TM80 only.	II
ECG 2 (5-lead, 6-lead)		I
Va (For 6-lead only)		Va
Vb (For 6-lead only)		Vb
ECG Gain	Configures the size of each ECG waveform.	x1
Speed	Configures the ECG wave speed.	25 mm/s
Filter	Configures the ECG filter in all operating modes. <ul style="list-style-type: none"> ■ Monitor: use under normal measurement conditions. ■ ST use when the ST monitoring is applied. 	Monitor
Notch Filter	Configures whether or not to switch on the notch filter.	On
Lead Set	3-Lead, 5-Lead, 6-Lead 6-Lead is for available at TM80 only.	

* *The factory default settings are in bold.*

12.3.2.3 Changing Pacer Settings

To change pacer related settings, follow this procedure:

1. From the **ECG** tab, select the **Pacer** section.

2. Set the desired items.

Options or Buttons	Description	Default Setting
Paced	The option is not configurable at the CMS. The paced status can be set at the TD60/TM80 only. See " Setting the Paced Status " on page 7 - 12 for details.	None
Pacer Reject	Configures whether or not to reject the pace pulses. <ul style="list-style-type: none"> ■ On: the pace pulses are not counted as extra QRS complexes. ■ Off: the pace pulses are not rejected. 	Off
	This option is only available when Paced is set to Yes at the TD60/TM80.	
Pacemaker Rate (bpm) (only Mortara ECG algorithm)	When some pacemaker pulses are difficult to reject, the pulses are counted as a QRS complex and could result in an incorrect HR and failure to detect some arrhythmias. Configures the pacemaker rate, the system can calculate HR and detect arrhythmias more accurately.	60
	The option is unavailable when Paced is set to No at the TD60. For details about the paced status, See " Setting the Paced Status " on page 7 - 12.	

12.3.2.4 Adjusting the Minimum QRS Detection Threshold

To avoid false asystole alarms when the R wave amplitude is low and missed asystole alarms during ventricular standstill (tall P waves, but no QRS), a means to manually adjust the minimum QRS detection threshold is provided.

To adjust the QRS detection threshold, follow this procedure:

1. From the **ECG** tab, select the **Setup** section.
2. From the **ECG** tab, select the **QRS Threshold** section.
3. Select the arrow buttons to adjust the QRS threshold. Selecting **Default** resets the QRS threshold to the default value (0.16 mV).

CAUTION

- **The setting of QRS threshold can affect the sensitivity of arrhythmia, ST, QT/QTc detection, and heart rate calculation.**
- **If QRS amplitude is low, the monitor might not be able to calculate heart rate and false asystole may occur.**

12.3.2.5 ECG Display

ECG Digital Area

The ECG digital area displays:

1. HR unit
2. Parameter label
3. HR value
4. Low HR alarm limit
5. High HR alarm limit

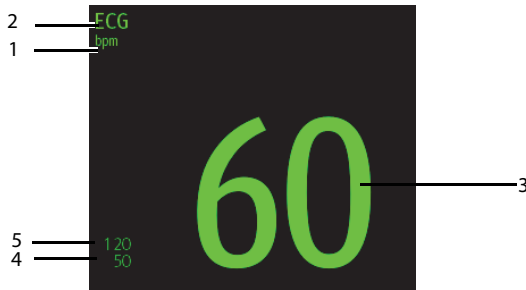

ECG digital area

NOTE

- If an alarm for a parameter is disabled, the  symbol is displayed on the right of this parameter.

ECG Waveform Area

The ECG waveform area displays:

1. ECG Lead
2. ECG waveform size
3. ECG filter setting
4. Notch filter setting
5. ECG waveform
6. ECG scale

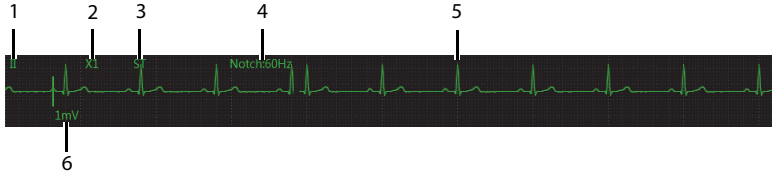

12.3.3 QT Monitoring

For description about QT monitoring, see **"QT Monitoring" on page 12 - 17.**

To enter the **QT** tab, follow this procedure:

1. Select the ECG digital area or waveform area to enter the **ECG** menu on the ViewBed screen of the CMS.
2. Select the **QT** tab.

12.3.3.1 Measurement Limitations

QT/QTc values are calculated with 3/5-leadwire ECG cables for the TMS60 and with a 3/5/6-leadwire ECG cables for the TM80.

12.3.3.2 Setting QT Alarm Properties

To set QT alarm properties, follow this procedure:

1. From the **QT** tab, select the **Alarm** section.
2. Set the desired alarm properties.

For the default alarm properties, See **"Factory Default Parameter Alarm Settings" on page 12-4.**

12.3.3.3 Changing QT Settings

To change QT related settings, follow this procedure:

1. From the **QT** tab, select the **Setup** section.
2. Set the desired items.

Options	Description	Default Setting
QT Analysis	Enables or disables QT analysis.	Off

Options	Description	Default Setting
QT View	Select to display the QT View menu.	None
	This button is only available for the advanced ECG algorithm. See " QT View Menu (Only for Advanced ECG Algorithm) " on page 12 - 18 for details.	
Set Baseline	Configures the baseline to quantify changes in the QTc value.	None

12.3.3.4 QT View Menu (Only for Advanced ECG Algorithm)

Select **QT View** at the bottom of the **QT** menu to enter the **QT View** menu.

In the **QT View** menu, you can view a snapshot of the real-time wave and to verify that the QT algorithm detects correct Q and T points.

The **QT View** menu displays, as shown in the following figure:

- The current waveform and parameter values display in green.
- The template waveform and parameter values display in yellow.
- The Q and T points are marked with a vertical line.
- The Δ QTc value is equal to the current QTc value minus the template QTc value.



QT View menu

Using the buttons described in the following table as desired.

Buttons	Description	Settings*
Left or right arrow	Select the desired lead to display on the QT View menu screen by selecting the left or right arrow.	II, I, III, aVR, aVL, aVF, V
Set Baseline	Set an ST baseline when ST values become stable.	None
	The QT template updated time displays at the bottom of the screen.	
Hide Baseline	Hides the reference baseline.	None

* *The factory default settings are in bold.*

12.3.3.5 QT Display

When **QT Analysis** is enabled, the QT digital area displays:

1. Parameter label
2. QTc value
3. Δ QTc value
4. QT value
5. QTc alarm limit (if QTc alarm is off, the alarm off symbol is displayed)

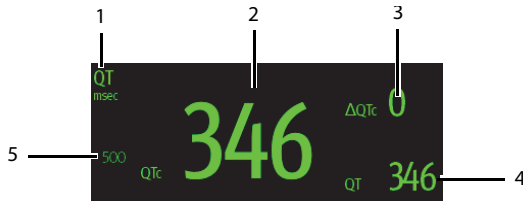

NOTE

- **The display of the QT numeric area differs as related settings change.**

12.3.4 ST Monitoring

For description about ST monitoring, see "**ST Monitoring**" on page 12 - 21.

To enter the **ST** tab, follow this procedure:

1. Select the ECG digital area or waveform area to enter the **ECG** menu on the ViewBed screen of the CMS.
2. Select the **ST** tab.

12.3.4.1 Measurement Limitations

For measurement limitations, see "**Measurement Limitations**" on page 12 - 22

12.3.4.2 Setting ST Alarm Properties

To set ST alarm properties, follow this procedure:

1. From the **ST** tab, select the **Alarm** section.
2. Set the desired alarm properties.

For the default alarm properties, See "**Factory Default Parameter Alarm Settings**" on page 12-4.

12.3.4.3 Changing ST Settings

To change ST related settings, follow this procedure:

1. From the **ST** tab, select the **Setup** section.
2. Set the desired items.

Options or Buttons	Description	Default Setting
ST Analysis	Enables or disables ST analysis.	Off
ST Segments	Select whether or not to display the ST segments in the waveform area.	Auto
Show Marker	Select whether or not to display the ISO point, J point, and ST point mark do not display on the ST segments.	Off

* *The factory default settings are in bold.*

Options or Buttons	Description	Default Setting
ST Alarm Setup	Configures the ST alarm settings.	<ul style="list-style-type: none"> ■ For details about the ST alarms limits, See "Factory Default Parameter Alarm Settings" on page 12 - 4 for details. ■ For details about the ST alarms responses, See "Factory Default Parameter Alarm Settings" on page 12 - 4 for details.
Define ST Point	Select to display the Define ST Point menu.	See " Adjusting ST Measurement Points " on page 12 - 23 for details.
	This button is only available when ST Analysis is set to On .	

* *The factory default settings are in bold.*

12.3.4.4 Adjusting ST Measurement Points

The ISO and ST points need to be adjusted when you start monitoring and if the patient's heart rate or ECG morphology changes significantly. Exceptional QRS complexes are not considered for ST-segment analysis.

WARNING

- **Always make sure that the ST measurement points are appropriate for your patient.**
-
-

To adjust ST measurement points, follow this procedure.

1. From the **ST** tab, select the **Adjust** section.
2. Set **ST Point**.
3. Enable or disable **Auto Adjust**. This option defines the method of adjusting the ISO point and J point.
 - ◆ Enabled: It is enabled by default. In this case, positions of ISO point and J point are automatically adjusted accordingly.
 - ◆ Disabled: you need to manually adjust the position of ISO point and J point by selecting the arrows at the right sides of ISO and J.

12.3.4.5 Entering the ST Graphic Window

To enter the ST Graphic window, follow this procedure:

1. Select the ECG digital area or waveform area to enter the **ECG** menu on the ViewBed screen of the CMS.
2. Select the **ST** tab to enter the **ST** menu.
3. From the bottom of the ST menu, select **ST Graphic**.

In the ST graphic window:

- The white parts indicate the baseline ST value.
- The color of Δ ST indicates alarm status. Green indicates that Δ ST is within alarm limits. Yellow and red indicate that Δ ST exceeds the alarm limits. The color matches the priority of Δ ST alarm.

12.3.4.6 Entering the ST View

The ST View shows a complete QRS segment for each ST lead. The color of current ST segments and ST values is consistent with the color of ECG waveforms, normally green. The color of baseline ST segments and ST values is white.

To enter the ST View, follow this procedure:

1. Select the ECG digital area or waveform area to enter the **ECG** menu on the ViewBed screen of the CMS.
2. Select the **ST** tab to enter the **ST** menu.
3. From the bottom of the menu, select **ST View**.
4. Set the desired items.

Buttons	Description	Settings*
Set Baseline	Set an ST baseline when ST values become stable.	None
	The QT template updated time displays at the bottom of the screen.	
Display/Hide Baseline	Displays or hides the reference baseline.	None
Display/Hide Marker	Displays or hides the position of ISO point, J point and ST point.	

12.3.4.7 ST Display

When **ST Analysis** is enabled, the ST digital area displays:

1. Parameter label
2. ST unit

3. ST alarm off symbol
4. Lead labels
5. ST numerics: a positive value indicates ST segment elevation, and a negative value indicates ST segment depression.

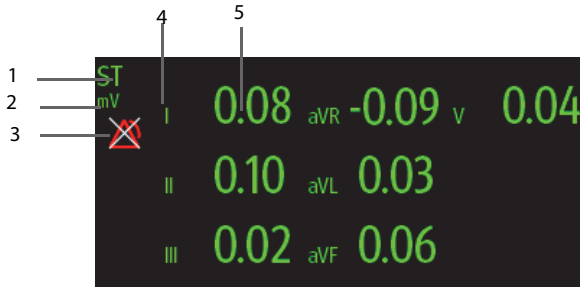

Example 5-lead ST digital area

12.3.4.8 ST Segment Display

The ST segments display in the waveform area:

1. Lead labels
2. ST markers (ISO, J/ST)
3. Current ST value
4. Baseline ST value
5. ST unit

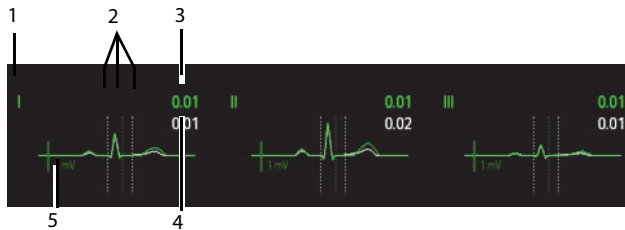

5-lead ST segments

12.3.5 Arrhythmia Monitoring

For description about arrhythmia monitoring, see "*Arrhythmia Monitoring*" on page 12 - 25.

To enter the **Arrhythmia** tab, follow this procedure:

1. Select the ECG digital area or waveform area to enter the **ECG** menu on the ViewBed screen of the CMS.
2. Select the **Arrhythmia** tab.

12.3.5.1 Measurement Limitations

For measurement limitations about arrhythmia monitoring, see "*Measurement Limitations*" on page 12 - 26.

12.3.5.2 Understanding the Arrhythmia Events

For description about arrhythmia events, see "*Understanding the Arrhythmia Events*" on page 12 - 26.

12.3.5.3 Setting Arrhythmia Alarm Properties

To set arrhythmia alarm properties, follow this procedure:

1. From the **Arrhythmia** tab, select the **Alarm** section.
2. Set the desired alarm properties.

For the default alarm properties, See "*Factory Default Parameter Alarm Settings*" on page 12-4.

12.3.5.4 Changing Arrhythmia Alarm Threshold Settings

You can change threshold settings for some arrhythmia alarms. When an arrhythmia violates its threshold, an alarm will be triggered. To do so, follow this procedure:

To change arrhythmia settings, follow this procedure:

1. From the **Arrhythmia** tab, select the **Threshold** section.
2. Set the desired items.

12.3.5.5 Setting PVC-Related Alarms Threshold

PVC-related alarms are detected on the basis of the current ventricular heart rate and the number of consecutive PVCs.

To set the threshold of PVC-related alarm threshold, follow this procedure:

1. From the **Arrhythmia** tab, select the **More Threshold** section.
2. Set the desired items using the right or left arrow.

The following figure illustrates the conditions under which PVC alarms will be generated if **V-Tach PVCs** is set to 6, **V-Tach Rate** is set to 130, **V Brady PVCs** is set to 5, and **V Brady Rate** is set to 40.

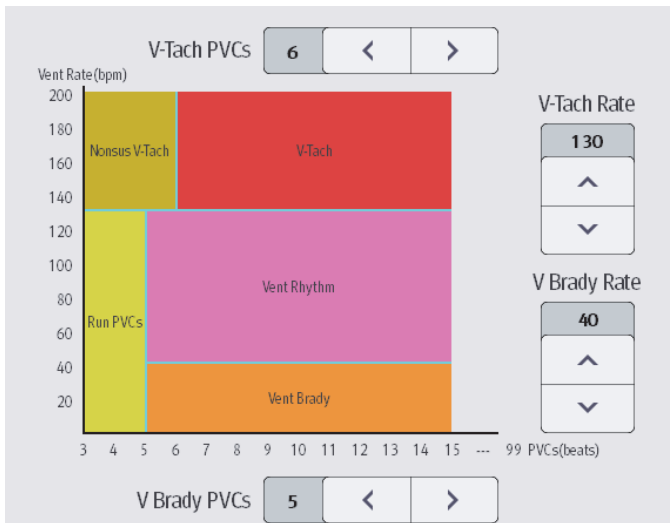

If both V-Tach PVCs and V-Tach Rate are greater than or equal to the limits, a V-Tach alarm is generated.

- If consecutive PVCs is lower than the V-Tach PVCs limit (6) but greater than 2, and the Vent rate is greater or equal to the V-Tach Rate limit (130), a Nonsus V-Tach alarm is generated.
- If consecutive PVCs is greater than or equal to the V Brady PVCs limit (5), and the Vent rate is lower than the V Brady limit (40), a Vent Brady alarm is generated.
- If both the V Brady PVCs and V Brady Rate are lower than the limits, but V Brady PVCs is greater than 2, a Run PVCs alarm is generated.
- If the V Brady PVCs and V Brady Rate are greater than or equal to limits, but the Vent rate is lower than V-Tach Rate (130), a Vent Rhythm alarm is generated.

12.3.5.6 Arrhythmia Display

When **Arrhythmia** is selected to display in the **Tile Layout**, the arrhythmia digital area displays:

1. Parameter label
2. Measurement unit
3. Arrhythmia alarm off symbol
4. PVCs per minute label
5. Pauses per minute label
6. PVCs per minute value
7. Pauses per minute value



12.3.5.7 Relearning

For details about relearning, see **"Relearning" on page 12 - 29**.

12.3.6 Resp Monitoring

At the CMS, you can view and change Resp settings in the **Resp** menu.

Select the Resp digital area or waveform area on the ViewBed screen of the CMS to enter the **Resp** menu.

12.3.6.1 Setting Resp Alarm Properties

To set Resp alarm properties, follow this procedure:

1. In the **Resp** menu, select the **Alarm** tab and **PR Alarm** tab respectively.
2. Set the desired alarm properties.

For the default alarm properties, See "Factory Default Parameter Alarm Settings" on page 12 - 4 .

12.3.6.2 Changing Resp Settings

To change Resp related settings, follow this procedure:

1. In the **Resp** menu, select the **Setup** tab.
2. Set the desired items.

Options	Description	Default Setting
Gain	Configures the Resp waveform size.	x2
Speed	Configures the Resp wave speed.	6.25mm/s

12.3.6.3 Resp Display

Resp Digital Area

The Resp digital area displays:

1. Parameter label
2. RR value
3. RR source
4. Low RR alarm limit
5. High RR alarm limit
6. RR unit

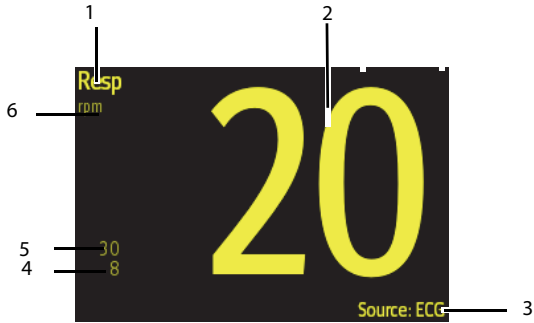

Resp Waveform Area (For TM60 Only)

At the CMS, you can view the Resp waveform for the TM80. The CMS does not display the Resp waveform for the TD60

The Resp waveform area displays:

- 1. Parameter label
- 2. Resp size
- 3. Resp waveform
- 4. Resp lead

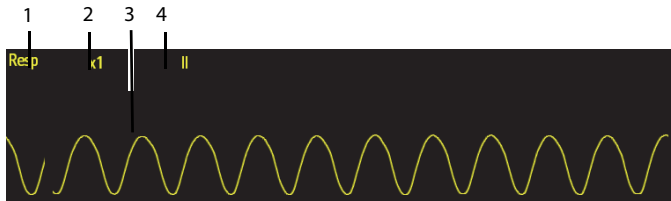

12.3.7 SpO₂ Monitoring

At the CMS, you can view and change the SpO₂ settings in the **SpO₂** menu.

Select the SpO₂ digital area or waveform area on the ViewBed screen of the CMS to enter the **SpO₂** menu.

12.3.7.1 Measurement Limitations

See "Measurement Limitations" on page 9 - 3 for details.

12.3.7.2 Setting SpO₂ Alarm Properties

To set ECG alarm properties, follow this procedure:

1. In the **SpO₂** menu, select the **Alarm** tab and **PR Alarm** tab respectively.
2. Set the desired alarm properties.

For the default alarm properties, See "**Factory Default Parameter Alarm Settings**" on **page 12-4**.

12.3.7.3 Changing SpO₂ Settings

To change ECG waveform related settings, follow this procedure:

1. In the **SpO₂** menu, select the **SpO₂ Setup** tab.
2. Set the desired items.

Options	Description	Settings*
Sensitivity (Masimo only)	The option is not configurable. The option setting is synchronous with the setting at the TD60/TM80. See "Configuring the SpO ₂ Setup" on page 9 - 7".	None
Display PI		
Speed	Configures the Pleth wave speed.	25 mm/s
Averaging (Masimo only)	The option is not configurable. The option setting is synchronous with the setting at the TD60/TM80. See "Configuring the SpO ₂ Setup" on page 9 - 7 for details.	

12.3.7.4 SpO₂ Display

SpO₂ Digital Area

The SpO₂ digital area displays:

1. Parameter name
2. High SpO₂ alarm limit
3. PR label
4. PR value
5. High PR alarm limit
6. SpO₂ unit of measure
7. Low PR alarm limit
8. Masimo perfusion index value
9. PI label
10. Low SpO₂ alarm limit
11. SpO₂ value

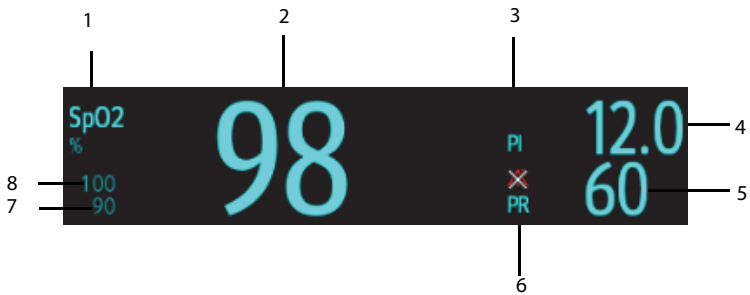

Masimo SpO₂ digital area



Nonin SpO₂ digital area

12.3.7.5 SpO₂ Waveform Area

The SpO₂ waveform area displays:

1. Parameter label
2. Pleth waveform

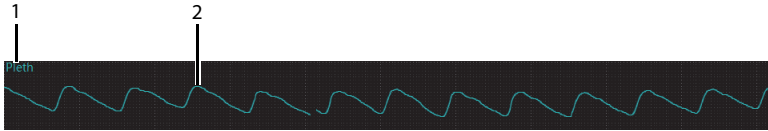

SpO₂ waveform area

12.3.8 NIBP Monitoring

At the CMS, you can view and change NIBP settings in the **NIBP** menu.

Select the NIBP digital area on the ViewBed screen of the CMS to enter the **NIBP** menu.

12.3.8.1 Measurement Limitations

See *BP10 NIBP Module Operator's Manual (P/N 046-011008-00)* for details.

12.3.8.2 Setting NIBP Alarm Properties

To set NIBP alarm properties, follow this procedure:

1. In the **NIBP** menu, select the **Alarm** tab.
2. Set the desired alarm properties.

For the default alarm properties, See *"Factory Default Parameter Alarm Settings"* on [page 12-4](#).

12.3.8.3 Changing NIBP Settings

To change NIBP related settings, follow this procedure:

1. In the **NIBP** menu, select the **Setup** tab.
2. Set **Interval**.

12.3.8.4 NIBP Display

The NIBP area displays numerics, as shown below:

1. Parameter label
2. Systolic pressure
3. Diastolic pressure
4. Diastolic pressure high limit
5. Mean pressure high limit
6. Mean pressure low limit
7. Mean pressure obtained after the measurement and cuff pressure obtained during the measurement
8. Diastolic pressure low limit
9. Systolic pressure low limit
10. Systolic pressure high limit

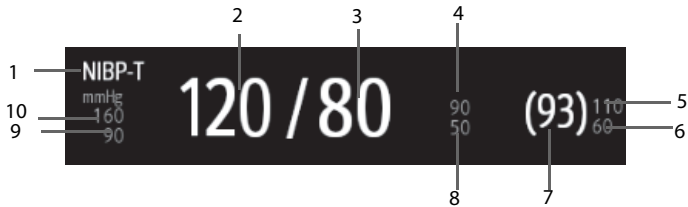

12.3.8.5 NIBP List

When **NIBP List** is selected to display in the **Tile Layout**, the NIBP list area displays multiple sets of most recent NIBP measurements. The displayed PR is derived from NIBP.

NIBP List				PR	Time
mmHg	117/79	(87))	79	18:15
	115/80	(87))	79	18:00
	115/80	(87))	79	17:44

NOTE

- **NIBP List cannot be displayed on some screens such as the big numerics screen.**

12.3.9 Locating the TM80

If the AP information of the TM80 has been imported into the CentralStation, you can view device location information for WiFi devices. For details on how to import AP information, see ***BeneVision Central Monitoring System Operator's Manual (P/N 046-010879-00)***.

To view device location, follow this procedure:

1. Select the  symbol at the top of the ViewBed screen. The **Device Location** menu is displayed.
2. View the AP switch time in the Time column and the current location of devices in the **Location** column.

If you wish to locate a TM80 telemetry device, select the **Find Device** button. The TM80 will generate a continuous audible tone until it is acknowledged at the TM80.

NOTE

- **Find Device requires that the TM80 has sufficient battery power and is within the coverage area.**
-

This page intentionally left blank.

13 Battery

Introduction	13-2
Safety.....	13-2
Installing the Battery	13-4
Checking the Battery Charge Status	13-4
Removing the Battery	13-4
Charging the Rechargeable Lithium-ion Battery	13-5
Storing the Batteries	13-6
Maintaining the Rechargeable Lithium-ion Battery.....	13-7
Disposing of the Batteries.....	13-8

13.1 Introduction

The TD60/TM80 can be powered by a lithium-ion rechargeable battery pack or AA batteries. This chapter provides instructions on how to use, maintain, and dispose of the batteries.

13.2 Safety

WARNING

- **Keep the batteries out of children's reach.**
 - **Keep the batteries in their original package until you are ready to use them.**
 - **Make sure to install the lithium-ion battery pack or the AA battery tray and close the battery compartment during defibrillation.**
 - **Only use recommended AA batteries or rechargeable lithium-ion battery to power the TD60/TM80. Other power supply may cause damage to the equipment or lead to body injury.**
 - **While installing AA batteries, do not apply reverse polarity.**
 - **Only use recommended fresh AA batteries. Using other AA batteries can give unacceptable performance.**
 - **Do not mix batteries of different charge/voltage levels.**
 - **Do not mix batteries of different chemistries.**
 - **Only use specified rechargeable lithium-ion battery. Unspecified lithium-ion battery can give unacceptable performance.**
 - **Use caution when handling the lithium-ion rechargeable battery pack. Misuse or abuse may cause bodily injury or device damage.**
 - ◆ **Do not short circuit. Take care that the terminals do not contact metal or other conductive materials during transport and storage.**
 - ◆ **Do not crush, drop or puncture the battery. Mechanical abuse can lead to internal damage and internal short circuits. If a battery has been dropped or banged against a hard surface, whether damage is externally visible or not, remove the battery from use and dispose of it properly.**
 - ◆ **Do not incinerate batteries or expose them to temperatures above 60°C (140°F).**
-
-

WARNING

- **The rechargeable lithium-ion batteries should be charged in the specified central charger.**
 - **If a battery shows signs of damage or signs of leakage, replace it immediately. Use caution in removing the battery. Avoid contact with skin. Refer to qualified service personnel.**
 - **Some failure conditions, such as short circuits, can cause a battery to overheat during using. High temperature can cause burns to the patient or user. If the device becomes too hot to the touch, remove it from the patient and place aside until it cools. Then remove the battery from the device, and contact your service personnel to identify the cause of overheating.**
 - **Replace the battery immediately once the “Critically Low Battery” alarm message displays. Replace the battery in time once the “Low Battery” alarm message displays. If those conditions are not corrected, device shutdown and cessation of monitoring will result. After replacing the rechargeable lithium-ion battery, charge it in time. Do not store the lithium-ion battery whose batter power is depleted but is not charged yet.**
 - **To eliminate the risk of electrical shock or burn, do not carry loose batteries on your person, such as placing the battery in clothing pockets.**
-
-

CAUTION

- **Remove the battery before transporting the device or if the device is not in use or is being stored.**
 - **The TD60/TM80 cannot be used for monitoring if the battery compartment is wet. Remove the batteries and wipe the compartment dry before continued monitoring.**
 - **AA batteries should be removed from the device at the end of the battery’s useful life to prevent leakage. In case of battery leakage, use caution to remove the batteries and clean the battery compartment. Install fresh AA batteries and check if the TD-60 can power on properly. If the TD-60 fails to power on, contact your service personnel.**
-
-

NOTE

- **Batteries of different types may give different performance such as battery runtime and insufficient battery low or critically low warning time.**
-

13.3 Installing the Battery

Refer to "Installing the Batteries" on page 3 - 6 for details.

13.4 Checking the Battery Charge Status

The battery symbol displaying on the top of main screen indicates the battery charge status. The white part () indicates the remaining battery charge.

NOTE

- **If the "Low Battery" or "Critically Low Battery" alarm occurs, the TD60/TM80 turns off the audio, the screen display the "Local Audio Off" message, and the screen brightness turns dimmer.**
-

13.5 Removing the Battery

CAUTION

- **Some failure conditions, such as short circuits, can cause a battery to overheat during using. High temperature can cause burns to the patient or user. If the device becomes too hot to the touch, remove it from the patient and place aside until it cools. Then remove the battery from the device, and contact your service personnel to identify the cause of overheating.**
 - **Avoid scraping the metal contactor in the battery compartment while removing the lithium-ion battery pack or AA battery frame. Otherwise, the broken contact will affect the power supply performance.**
 - **Remove the battery before transporting the device or if the device is not in use or is being stored.**
-

NOTE

- **Retain the ECG cable and SpO₂ module with the device while removing the battery.**
-

1. Lift up the lithium-ion battery pack or AA battery tray at the bottom of the TD60/TM80.

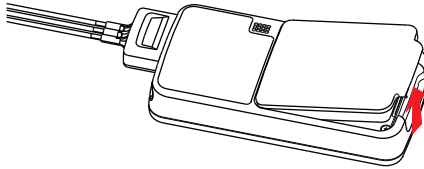

2. Remove the lithium-ion battery pack or AA battery tray from the TD60/TM80.

13.6 Charging the Rechargeable Lithium-ion Battery

WARNING

- **Only use the specified central charger to charge to the lithium-ion batteries designated by Mindray.**
 - **Only use the approved power cord with the grounded mains plug to firmly connect the central charger to a grounded AC mains socket. Never refit the mains plug to fit an ungrounded AC mains socket.**
 - **Do not use the Multiple Portable Socket Outlets (MPSO) or AC mains extension cords. Use an IEC 60601-1 approved isolation / separation transformer, otherwise, it may result in leakage current. Insure that the sum of the individual ground leakage currents does not exceed the allowable limits.**
 - **Do not place any shield object (such as cloth or paper) to cover the central charger or batteries, and keep ventilated while charging the lithium-ion batteries.**
 - **Do not connect other devices to the power supply system.**
 - **Do not use the central charger to charge the lithium-ion batteries in high temperature above 40°C.**
-

Use the central charger to charge the lithium-ion batteries. The central charger can charge 10 lithium-ion batteries at one time. For details about the central charger, refer to the ***BeneVision Central Charger Operator's Manual (P/N 046-007059-00)***.

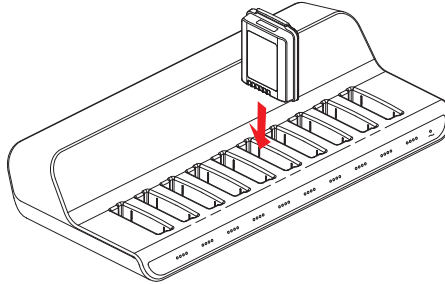

13.7 Storing the Batteries

13.7.1 Storing Rechargeable Lithium-ion Battery

When storing batteries, make sure that the battery terminals do not come into contact with metallic objects.

If you need to store the batteries for an extended period of time, place the batteries in a cool, dry place (ideally at 15°C or 60°F) with a partial charge of about 50% capacity (two LEDs illuminated). Storing batteries in a cool place can slow the aging process.

Stored batteries should be charged to about 50% of their capacity every six months. The battery should be fully charged prior to first use.

NOTE

- **Remove the lithium-ion battery from the device if the device is not used for a prolonged time (for example, several weeks), and keep the device in clean place to avoid the dust or liquid entering the battery compartment.**
- **Storing batteries at high temperatures for an extended period of time will significantly shorten their life expectancy.**
- **Do not store the batteries in an environment above 60°C (122°F) or lower than -20°C (4°F).**

13.7.2 Storing AA Batteries

If you remove undepleted AA batteries from the TD60/TM80 and need to store the batteries, keep the batteries together as a set for later re-use so that all batteries will have the same level of remaining power.

Do not store disposable AA batteries by leaving the batteries in the incorrect polarity position in the TD60/TM80.

NOTE

- **Replace the AA battery tray on the battery compartment after removing the AA batteries.**

13.8 Maintaining the Rechargeable Lithium-ion Battery

Take care of the rechargeable lithium-ion battery once you receive a new battery for use. The following table describes the battery maintenance activities and recommended frequency.

Activity	Recommended Frequency
Visual inspection	Before installing a battery in the TD60/TM80.
Charge the battery	Upon receipt, after use, a "Low Battery" or "Critically Low Battery" alarm occurs. To optimize performance, a fully or almost fully discharged battery must be charged immediately.
Clean the battery	At each patient discharge, or in case that the battery is exposed to contaminants. Do not clean the battery connector during the cleaning.
Charge stored battery to at least 40% of the battery capacity.	Every six months if the TD60/TM80 is not in use for an extended period of time.
Dispose of the battery	When the "Battery Maintenance Required" alarm message displays on the TD60/TM80.

The lifetime of a lithium-ion battery depends on the frequency and duration of use. With good maintenance, the useful life is approximately 500 complete charge-discharge cycles. Experience indicates that the incidence of failure may increase with battery service life due to the accumulated stresses of daily use. Therefore, Mindray strongly recommend that lithium-ion battery should be replaced after two years or 500 complete charge-discharge cycles. Using the outdated battery may cause the device abnormality and unacceptable performance.

The age of a lithium-ion battery begins at the date of manufacture. The date of manufacture is listed on the rear of the battery.

NOTE

- **The battery capacity degrades as using time and number of recharge cycles. Toward the end of its useful life, the battery capacity may be reduced by 20% to 25%. If the reduced battery life is unacceptable for your device, Mindray recommends the battery be replaced.**
-

13.9 Disposing of the Batteries

13.9.1 Disposing of the Rechargeable Lithium-ion Battery

Discard the lithium-ion battery in the following situations:

- The battery has visual signs of damage.
- The battery fails.
- The battery is aged and its runtime significantly less than the specification.
- The battery has been used for more than two years or 500 complete charge-discharge circles.

Discharge the battery and insulate the terminals with tape before disposal. Properly dispose of the batteries according to local regulations.

13.9.2 Disposing of the AA Batteries

The batteries may be subject to local regulations regarding disposal. Dispose of batteries in approved containers. Follow local regulations, if any, to recycle the batteries.

14 Troubleshooting

General Problems	14-2
Physiological Alarm Messages at the CMS	14-4
Technical Alarm Messages at the TD60/TM80.....	14-7

14.1 General Problems

The following table lists the problems that are likely to occur. If the problem persists after corrective actions have been taken, contact your service personnel.

Symptom	Possible cause	Solution
No RF Signal (The RC60 does not receive valid data for consecutive 5 seconds)	<ol style="list-style-type: none"> The TD60 battery charge is to be depleted. The patient is out of the antenna array coverage area. The TD60 is not connected with the ECG leadwire. 	<ol style="list-style-type: none"> Check if the TD60 battery charge is depleted. Check if the patient is out of the coverage area. Check if the TD60 is connected with the ECG leadwire properly.
RF Interference (The TD60 receives three consecutive wrong frames.)	The TD60 signal is weak.	Check if the Patient is at the edge of the coverage area or in an elevator. Remove behind a reinforced concrete wall.
SpO ₂ No Pulse	The SpO ₂ sensor failed to obtain pulse signal.	Check the patient's condition and change the sensor application site. If the error persists, replace the sensor.
The SpO ₂ data is not displayed on the CentralStation.	<ol style="list-style-type: none"> The SpO₂ module is not connected to the TD60. There may be error in the SpO₂ module. 	<ol style="list-style-type: none"> Connect the SpO₂ module to the TD60/TM80. If there is an error in the SpO₂ module, replace the SpO₂ module with a new one.
ECG noise	ECG waveforms are overlapped with the noise interference.	Check if the ECG leadwire is intertwined with cables of other devices.
ECG Signal Saturated	The TD60/TM80 detects that ECG signal saturation or overload.	<ol style="list-style-type: none"> Check if patient has excessive movement. Check if the electrodes are in good contact with the skin. Check if the electrodes operating time is over the electrode service life.
Wrong Channel	The configured frequency of the transmitter does not match the channel.	Reconfigure the frequency of the transmitter to match the channel.
The AC power indicator on the RC60 is off.	<ol style="list-style-type: none"> The RC60 is not connected to the power. The RC60 is power off. 	<ol style="list-style-type: none"> Check if the RC60 is connected to the power. Check if the RC60 sounds a beep when turn the receiver on.
The TD60/TM80 or SpO ₂ module restarts repeatedly.	The TD60/TM80 battery charge is to be depleted.	Replace with new batteries.

Symptom	Possible cause	Solution
The TM80 cannot be connected to the CMS wirelessly and the Wi-Fi symbol on the main screen of the TM80 is displayed as  .	The wireless access point (AP) in the vicinity is not enabled.	Make sure that the AP is enabled and belongs to the Virtual LAN (VLAN) where the TM80 is covered.
	The TM80 is not powered on under the AP coverage area.	Put the TM80 within the AP coverage area and restart it. Ensure that the signal strength displayed on the TM80 is greater than -65dBm.
	Items like SSID, IP acquisition mode are not configured correctly for the TM80.	Contact your service personnel.
	The working channel of AP is not configured properly.	
	The TM80 has a fault.	
The TM80 has been connected to the wireless network but cannot be connected to the CMS.	The TM80 is not admitted by the CMS yet.	
	Failed to acquire the IP address.	
	Static IP conflict	
Single TM80 is offline occasionally.	The TM80 is located in the blind area of WiFi coverage.	
	The TM80 has a fault.	
	Static IP conflict	
Some TM80s are offline occasionally.	AP in some area is damaged.	
	Severe interference occurs in some areas.	
	The signal strength is weak some areas.	
All the TM80s are offline occasionally.	Partial wired network is not configured properly.	
	Wireless interference	
The TD60/TM80 cannot establish connection with the BP10.	Configuration error	Verify that MPAN is enabled at the TD60 and the MPAN key on the BP10 is pressed. Verify that MPAN at the TM80 is set to Monitor/Sensor and the MPAN key on the BP10 is pressed.

Symptom	Possible cause	Solution
The TD60/TM80 and BP10 are prone to offline.	When the TD60/TM80 and BP10 are secured to the patient, signals may be blocked by the patient's body.	Put the TD60/TM80 and BP10 closer.
The TD60/TM80 and BP10 are prone to offline in certain area.	As there are many WiFi devices in this area, communication between the TD60/TM80 and BP10 is interfered seriously.	Contact your service personnel.
Some TD60/TM80 or BP10 is prone to offline.	Device malfunction	

14.2 Physiological Alarm Messages at the CMS

The following table lists the major telemetry-related physiological alarm messages displayed on the CMS screen.

NOTE

- **Physiological alarm messages for Resp and NIBP functionalities of the TMS60 telemetry monitoring system are only available at the CMS whose version is 03.00 or above.**
- **Physiological alarm messages for the TM80 are only available at the CMS whose version is 03.00 or above.**

Measurement	Alarm message	Alarm level	Possible cause	Solution
Heart rate (HR)	HR High	Med*	HR value has risen above the high alarm limit or fallen below the low alarm limit.	Check the patient's condition and make sure that the patient category and alarm limit settings are correct.
	HR Low	Med*		

* The asterisk (*) means the alarm level is configurable.

Measurement	Alarm message	Alarm level	Possible cause	Solution
ECG	ECG Weak Signal	High	The ECG signal is so weak that the TM80 can't perform ECG analysis.	Check the patient's condition and the ECG connections.
	Asystole	High	The patient is in arrhythmia.	
	V-Fib/V-Tac	High		
	V-Tac	High		
	Vent Brady	High		
	Extreme Tachy	High		
	Extreme Brady	High		
	R on T	Med*		
	Run PVCs	Low*		
	Couplet	Prompt*		
	Multiform PVC	Med*		
	PVC	Prompt*		
	Bigeminy	Med*		
	Trigeminy	Med*		
	Tachy	Med*		
	Brady	Med*		
	Pacer Not Capture	Prompt*	The pacer appears abnormal.	Check the pacer.
	Pacer Not Pacing	Prompt*		
	Missed Beats	Prompt*	The ECG signal is so weak that the TM80 can't perform ECG analysis.	Check the patient's condition and the ECG connections.
	Nonsus V-Tach	Med*		
Vent Rhythm	Med*			
Pause	Low*			
Irr Rhythm	Prompt*			
A-Fib	Prompt*			

* The asterisk (*) means the alarm level is configurable.

Measurement	Alarm message	Alarm level	Possible cause	Solution
ECG	PVCs/min	Med*	The ECG signal is so weak that the TM80 can't perform ECG analysis.	Check the patient's condition and the ECG connections.
	Pauses/min	Med*		
Resp	RR High	Med*	RR value has risen above the high alarm limit or fallen below the low alarm limit.	Check the patient's condition and make sure that the patient category and alarm limit settings are correct.
	RR Low	Med*		
	No Chest Movement	High	The respiration signal was so weak that the TM80 cannot perform respiration analysis.	Check the patient's condition. Check the connections of the electrodes and leadwires..
	Resp Artifact	High	The patient's heartbeat has interfered with his respiration.	Check the patient's condition and the Resp connections.
SpO ₂	SpO ₂ Desat	High	The SpO ₂ value has fallen below the desaturation alarm limit.	Check the patient's condition and check if the alarm limit settings are correct.
	No Pulse	High	The pulse signal was so weak that the TM80 cannot perform pulse analysis.	Check the patient's condition, SpO ₂ sensor and measurement site.
NIBP	NIBP-Sys Too High	High	The NIBP systolic pressure is higher than the upper alarm limit.	Check the patient's condition and check if the alarm limit settings and patient category are correct.
	NIBP-Sys Too Low	High	The NIBP systolic pressure is lower than the lower alarm limit.	
	NIBP-Mean Too High	High	The NIBP mean pressure is higher than the upper alarm limit.	
	NIBP-Mean Too Low	High	The NIBP mean pressure is lower than the lower alarm limit.	
	NIBP-Dia Too High	High	The NIBP diastolic pressure is higher than the upper alarm limit.	
	NIBP-Dia Too Low	High	The NIBP diastolic pressure is lower than the lower alarm limit.	

* The asterisk (*) means the alarm level is configurable.

14.3 Technical Alarm Messages at the TD60/TM80

The following table lists the major technical alarm messages displayed in the message area of the TD60 and TM80.

The Alarm Indication column in the table below is capable of three different indication types: A, B, C.

- A: The alarm sound will be silenced, the alarm light will continue to indicate the alarm, a ✓ will appear before the alarm message. The  symbol appears on the top of the main screen.
- B: The technical alarm will be changed to the prompt message, it will not longer make sound or be indicated by the alarm light.
- C: The technical alarms are cleared, there will be no alarm indications.

Measurement	Alarm message	Alarm level	Alarm Indication	Possible cause	Solution
ECG	ECG Lead Off	Low*	B	The electrode has become detached from the patient or the lead wire has become disconnected from the adapter cable.	Check the connections of the electrodes and leadwires.
	ECG XX** Lead Off	Low*	B		
	ECG Module Error	High	A	An error occurred to the ECG module. There is a problem with the communications between the module and the TD60.	Restart the TD60. If the problem persists, contact your service personnel.
	ECG Noise	Low	A	The ECG signal is noisy.	Check for any possible sources of signal noise around the cable and electrode, and check the patient for great motion.
	ECG Cable Type Error	Low	B	Connect wrong ECG leadwire.	Reconnect the 3 or 5 lead ECG leadwire.
	HR Over-range	Low	A	HR exceeds the measurement limit.	Contact Mindray or your service personnel.

* The asterisk (*) means the alarm level is configurable.

** XX is the ECG lead name.

Measurement	Alarm message	Alarm level	Alarm Indication	Possible cause	Solution
Resp	Electrode Poor Contact	Prompt	/	The electrode has been used for a long time or the electrode contact is poor.	Check the electrode application. Reposition or replace the electrodes if necessary.
SpO ₂	SpO ₂ Sensor Off	Low*	B	The SpO ₂ sensor has become detached from the patient or the module.	Check the sensor application site and the sensor type, and make sure the sensor is not damaged.
	SpO ₂ Sensor Fault	Low	C	There is a fault with the SpO ₂ sensor.	Reconnect the sensor or use a new sensor.
	SpO ₂ No Sensor	Low	B	An unspecified SpO ₂ sensor has been used.	
	SpO ₂ Module Error	High	A		
	SpO ₂ Too Much Light	Low	A	There is too much light on the SpO ₂ sensor.	Move the sensor to a place with lower level of ambient light or cover the sensor to minimize the ambient light.
	SpO ₂ No Pulse	Low	A	SpO ₂ sensor failed to obtain pulse signal.	Move the sensor to a site with better perfusion.
	SpO ₂ Unplugged	Low	C	SpO ₂ module connector is disconnected from the TD60.	Reconnect the SpO ₂ module to the TD60.
	PR Over-range	Low	A	The measured PR value exceeds the measurement range.	Contact Mindray or your service personnel.
NIBP	MPAN Disconnected	Med	C	The MAPN is disconnected.	Enable the MPAN switch.
	NIBP Clock Needs To Be Set	Med*	C	The button cell does not have sufficient charge.	Reset the system time for the BP10.

* The asterisk (*) means the alarm level is configurable.

** XX is the ECG lead name.

Measurement	Alarm message	Alarm level	Alarm Indication	Possible cause	Solution
NIBP	NIBP Error	High	A	<ol style="list-style-type: none"> 1. An error occurred to the NIBP module. 2. There is a problem with communication between the TM80 and BP10. 	Restart the BP10.
	NIBP Cuff Loose	Low	C	<ol style="list-style-type: none"> 1. The NIBP cuff is not properly connected. 2. There is a leak in the airway. 	<ol style="list-style-type: none"> 1. Check the patient's condition and verify patient category. 2. Replace with an appropriate cuff and connect it correctly.
	NIBP Airway Error	Low	C	An airway error occurs.	Check the airway.
	NIBP Weak Signal	Low	C	The patient's pulse is weak or the cuff is loose.	Check the patient's condition and change the cuff application site. If the error persists, replace the cuff.
	NIBP Over-range	Low	C	The measured NIBP value is not within the specified range.	Contact your service personnel.
	NIBP Excessive Motion	Low	C	Patient's arm moves too much.	Check the patient's condition and reduce the patient motion.
	NIBP Cuff Over-pressure	Low	C	The NIBP airway may be occluded.	Check the airway and measure again.

* The asterisk (*) means the alarm level is configurable.

** XX is the ECG lead name.

Measurement	Alarm message	Alarm level	Alarm Indication	Possible cause	Solution
NIBP	NIBP Cuff or Airway Leak	Low	C	The NIBP airway may leak air.	<ol style="list-style-type: none"> 1. Verify that the cuff is properly connected. 2. Verify that the airway does not leak air.
	NIBP Timeout	Low	C	<ul style="list-style-type: none"> ■ Time is out. ■ The measurement time is over 120 seconds. 	<ol style="list-style-type: none"> 1. Check the patient's condition and NIBP connections. 2. Replace the cuff.
	NIBP Cuff and Patient Mismatch	Low	C	The cuff type applied mismatches the patient category.	<ol style="list-style-type: none"> 1. Check the patient's category. 2. Replace the cuff.
	Intervals Not Set	Low	C	The interval in Sequence mode is not set.	Set the intervals.
NIBP	NIBP-S Over-range	Low	A	The measured NIBP value is not within the measurement range.	Contact your service personnel.
	NIBP-Dia Over-range	Low	A		
	NIBP-M Over-range	Low	A		

* The asterisk (*) means the alarm level is configurable.

** XX is the ECG lead name.

Measurement	Alarm message	Alarm level	Alarm Indication	Possible cause	Solution
NIBP	NIBP Battery Error	High	A	The lithium-ion battery communication has an error.	Replace with a known good battery.
	NIBP Battery Depleted	High	A	The battery charge is almost depleted.	
	NIBP Voltage Error	High	A	The battery voltage is abnormal.	
	NIBP Battery Maintenance Required	Med	A	The lithium-ion battery is aging.	
Power	Low Battery	Med	A	The battery charge is low.	Replace with a known good battery.
	Critically Low Battery	High	A	The battery charge is almost depleted.	
	Battery Maintenance Required	Med	A	The lithium-ion battery is aging.	
	Battery Error	Med	A	The lithium-ion battery communication is error.	
	Battery Type Error	Med	A	The battery contacts are in bad contact.	

* The asterisk (*) means the alarm level is configurable.

** XX is the ECG lead name.

Measurement	Alarm message	Alarm level	Alarm Indication	Possible cause	Solution
System	Device Error	High	A	<ul style="list-style-type: none"> ■ The selftest error occurs to the TD60 main board. ■ The selftest error occurs to the p a r a m e t e r module, wireless module or Mindray PAN module. ■ The selftest error occurs to the parameter module communication or initialization. 	Restart the TD60. If the problem persists, contact your service personnel.
	Restoring Last Defaults Failed	Low	C	Restoring the last default configuration is error.	
	Loading Defaults Failed	Low	C	Loading the default configuration is error.	
	No CMS	Low	A	The TD60 is disconnected from the CMS	Check the network connection.

* The asterisk (*) means the alarm level is configurable.

** XX is the ECG lead name.

15 Cleaning and Disinfecting

Introduction	15-2
Safety Information	15-2
Cleaning and Disinfecting the Equipment	15-3
Cleaning and Disinfecting ECG Leadwires and SpO2 Sensors	15-7
Cleaning and Disinfecting Other Parts.....	15-8
Sterilization	15-9
Impact of Improper Cleaning or Disinfection.....	15-9

15.1 Introduction

In this chapter we describe how to clean and disinfect the TD60/TM80 and its accessories.

15.2 Safety Information

CAUTION

- **Use only Mindray approved cleaners and disinfectants and methods listed in this chapter to clean or disinfect your equipment. Warranty does not cover damage caused by unapproved substances or methods.**
 - **Mindray makes no claims regarding the efficacy of the listed chemicals or methods as a means for controlling infection. For the method to control infection, consult your hospital's infection control officer or epidemiologist.**
 - **Non-medical equipment does not provide the same level of protection against electrical shock. Do not touch the patient and any part of nonmedical equipment at the same time. Some examples of non-medical equipment are laser printers and nonmedical computers.**
 - **The responsible hospital shall carry out all cleaning and disinfection procedures specified in this chapter.**
 - **Avoid use of cleaners, materials or chemicals that may damage equipment surfaces, labels, or cause equipment failures.**
 - **Never immerse any part of the equipment or accessories in liquids or allow liquid to enter the interior.**
 - **Do not pour or spray any liquid directly on the equipment or accessories or permit fluid to seep into connections or openings.**
 - **Remove the equipment from use if liquid is spilled on the equipment or accessories. Contact your service personnel.**
 - **Check the equipment after cleaning and disinfecting. If there is any sign of damage, remove it from use.**
-

15.3 Cleaning and Disinfecting the Equipment



15.3.1 Approved Cleaning and Disinfecting Agents

The following table lists approved cleaning and disinfecting agents:

Product Name	Product Type	Active Ingredients
Sodium hypochlorite bleach*	Liquid	Sodium hypochlorite bleach 10%
Hydrogen peroxide*		Hydrogen peroxide 3%
Isopropanol*		Isopropanol 70%
1-Propanol*		1-Propanol 50%
CIDEX® OPA Solution		Ortho-Phthalaldehyde 0.55%
Metrex CaviCide1™		Diisobutylphenoxyethoxyethyl dimethyl benzyl ammonium chloride 0.28%, Isopropanol 17.2%
Virex® II 256		Didecyl dimethyl ammonium chloride 8.704%, n-Alkydimethyl benzyl ammonium chloride 8.190%
Virex® TB		n-Alkyl dimethyl benzyl ammonium chlorides 0.105%, n-Alkyl dimethyl ethylbenzyl ammonium chlorides 0.105%
Rely+On™ Virkon® Powder * (Used as 1% solution)	Powder	Used as 1% solution Biocidal active: Pentapotassium bis (peroxymonosulphate) bis (sulphate)(500g/kg), Contains dipotassium peroxodisulphate.

Product Name	Product Type	Active Ingredients
Alpet® D2 Surface Sanitizing Wipes	Wipes	Isopropyl Alcohol 58.6000%? Octyl Decyl Dimethyl Ammonium chloride 0.0075%, Dioctyl Dimethyl Ammonium Chloride 0.0030%
Clorox Dispatch® Hospital Cleaner Disinfectant Towels with Bleach		Sodium Hypochlorite 0.65%
Clorox Healthcare® Bleach Germicidal Wipes		Sodium Hypochlorite 0.55%
Clorox Healthcare® Hydrogen Peroxide Cleaner Disinfectant Wipes		Hydrogen Peroxide 1.4%
Diversey Oxivir® TB Wipes		Hydrogen Peroxide 0.5%
Metrex CaviWipes™		Diisobutylphenoxyethoxyethyl dimethyl benzyl ammonium chloride 0.28%, Isopropanol 17.2%
PDI Sani-Cloth® AF3 Germicidal Disposable Wipe		n-Alkyl dimethyl ethylbenzyl ammonium chlorides 0.14%, n-Alkyl dimethyl benzyl ammonium chlorides 0.14%
PDI Sani-Cloth® Bleach Germicidal Disposable Wipe		Sodium Hypochlorite 0.63%,other ingredients 99.37%
PDI Sani-Cloth® HB Germicidal Disposable Wipe		n-Alkyl dimethyl ethylbenzyl ammonium chlorides 0.07%, n-Alkyl dimethyl benzyl ammonium chlorides 0.07%
PDI Sani-Cloth® Plus Germicidal Disposable Cloth		n-Alkyl dimethyl ethylbenzyl ammonium chlorides 0.125%, n-Alky dimethyl benzyl ammonium chlorides 0.125%
PDI Super Sani-Cloth® Germicidal Disposable Wipe *		n-Alkyl dimethyl ethylbenzyl ammonium chlorides 0.25%, n-Alkyl dimethyl benzyl ammonium chlorides 0.25%, Isopropyl Alcohol 55.0%,
VIRAGUARD Hospital Surface Disinfectants		Isopropanol 70%,Other ingredients 30%

NOTE

- For equipment with the symbol , all the listed cleaning and disinfecting agents are available for use. For equipment without the symbol , only the cleaning and disinfecting agents marked with “*” are available for use.**

15.3.2 Cleaning the Equipment

Clean your equipment on a regular basis. Before cleaning the equipment, consult your hospital's regulations for cleaning the equipment.

Before cleaning the equipment, make the following preparation:

- Install the battery pack or battery tray and firmly close to seal the battery compartment.
- Insert the SpO₂ cover in the SpO₂ connector when SpO₂ is not in use.
- Insert the ECG leadwire plug into the ECG connector.



To clean the equipment, follow this procedure:

1. Shut down the device.
 2. Clean the display screen with wipes or a soft cloth moistened with one of the cleaning agents listed in **"Approved Cleaning and Disinfecting Agents" on page 15 - 3** only.
 3. Clean the exterior surface of the main unit and lithium-ion battery pack with wipes or a soft cloth moistened with one of the cleaning agents listed in **"Approved Cleaning and Disinfecting Agents" on page 15 - 3** only.
 4. Wipe off all the cleaning agent residue with a dry cloth.
 5. Dry the equipment in a ventilated, cool place.
-

CAUTION

- **Always dilute according to the manufacturer's instructions or use lowest possible concentration.**
 - **Take extra care when cleaning the display screen because it is more sensitive to rough cleaning method.**
 - **Never allow the cleaning solutions to spill or enter the plug, connector or battery compartment. If liquid has accidentally entered the equipment or its parts, shut down the equipment and have the device serviced by authorized service personnel.**
 - **Never immerse the lithium-ion battery pack, AA battery tray and AA batteries in any fluids.**
 - **As the battery compartment is not water proof, do not contact the battery contacts when cleaning the equipment.**
 - **Do not hook the battery contacts in the battery compartment with other objects. Otherwise, the battery contacts may be distorted.**
 - **Keep the battery compartment free away from any foreign objects.**
-

15.3.3 Disinfecting the Equipment

Disinfect the equipment as required in your hospital's servicing schedule using the disinfecting agents list in **"Approved Cleaning and Disinfecting Agents" on page 15 - 3**. Cleaning before disinfection is recommended.

CAUTION

- **To maximize effectiveness and minimize buildup of residual disinfectants, please strictly adhere to disinfectant manufacturer's instructions for use.**
 - **Wring excess disinfectant from wipe before using.**
 - **Never allow the disinfectants to spill or enter the plug, connector or battery compartment. If liquid has accidentally entered the equipment or its parts, shut down the equipment and have the device serviced by authorized service personnel.**
-

15.4 Cleaning and Disinfecting ECG Leadwires and SpO₂ Sensors

To clean and disinfect reusable ECG leadwires and SpO₂ sensors, refer to the instructions for use delivered with the accessory.

15.5 Cleaning and Disinfecting Other Parts

Other parts refer to the interior surface of lithium-ion battery pack or battery tray, the battery compartment, ECG connector, SpO₂ connector, and SpO₂ cable, as shown below.



Clean or disinfect other parts only when needed or as required in your hospital's servicing schedule.

To clean and disinfect other parts, follow this procedure:

1. Shut down the device.
2. Remove the lithium-ion battery pack or battery tray from the TM80.
3. Unplug the ECG leadwire and SpO₂ cable from the TM80.
4. Clean and disinfect other parts with a soft cloth moistened with alcohol. During cleaning and disinfection, always avoid metallic objects.
5. Wipe off the alcohol residue with a dry cloth.
6. Dry these parts in a ventilated, cool place.

CAUTION

- **Do not clean or disinfect the metal objects.. Otherwise, metal part corrosion or product reliability deterioration could result.**
-

15.6 Sterilization

Sterilization is not recommended for this equipment, related products, accessories or supplies unless otherwise indicated in the instructions for use delivered with the products, accessories or supplies.

15.7 Impact of Improper Cleaning or Disinfection

Using cleaning agents or disinfectants other than those recommended may have the following impact:

- Product discoloration
- Metal part corrosion
- Brittle and breaking wires, connectors, and equipment housing
- Reduced cable and leadwire life
- Overall system performance degradation
- Equipment malfunction or failure

This page intentionally left blank.

16 Maintenance

Introduction	16-2
Safety.....	16-2
Regular Check	16-3
Maintenance and Testing Schedule	16-4
Power-on Test.....	16-5
Verifying the ECG at the TD60/TM80	16-5
NIBP Accuracy Test	16-5
NIBP Leakage Test	16-5
Nurse Call Test	16-5
Electrical Safety Tests.....	16-6
Battery Check	16-6
Viewing System Information	16-6

16.1 Introduction

The chapter outlines the routine telemetry devices maintenance guidelines.

The telemetry devices are designed for stable operation over long periods of time. Under normal circumstances the devices should not require technical maintenance beyond that described in this chapter. However, routine maintenance, calibration and safety checks are recommended at least once a year or more often as required by local statutory or hospital administration practice.

16.2 Safety

WARNING

- **Failure on the part of the responsible individual hospital employing the use of this equipment to implement a satisfactory maintenance schedule may cause undue equipment failure and possible health hazards.**
 - **The safety checks or maintenance involving any disassembly of the equipment should be performed by service personnel. Otherwise, undue equipment failure and possible health hazards could result.**
 - **No modification of this equipment is allowed.**
 - **Do not open the equipment housings. All servicing and future upgrades must be carried out by the service personnel.**
 - **All replaced components and accessories as well as consumables are provided or qualified by Mindray.**
 - **If you discover a problem with any of the equipment, contact your service personnel or Mindray.**
 - **The service personnel must be properly qualified and thoroughly familiar with the equipment operation.**
-
-

16.3 Regular Check

Perform a visual inspection before the equipment is first used every day. Verify that the equipment meets the following requirements:

- The housing and display screen are free from cracks or other damages.
- All keys function properly.
- Connectors are not loose, cracked, or bent and cables have no cuts, nicks, or fraying.
- ECG leadwires are securely connected with the equipment
- Battery pack is installed and has sufficient charge.

After your equipment has been used for 6 to 12 months, or whenever your equipment is repaired or upgraded, a thorough inspection should be performed by qualified service personnel to ensure the reliability.

Follow these guidelines when inspecting the devices:

- Make sure that the environment and power supply meet the requirements.
- Inspect the devices and their accessories for mechanical damage.
- Inspect all plugs, connectors, leadwires for damage, and make sure that their insulation is in good condition.
- Make sure that only specified accessories are applied.
- Make sure that the alarm system functions correctly.
- Make sure that the battery meet the performance requirements.
- Make sure that the devices are in good working condition.

In case of any damage or abnormality, do not use the devices. Contact the hospital's bio-medical engineers or your service personnel immediately.

16.4 Maintenance and Testing Schedule

The following maintenance and tests, except for visual inspection, power on test, and battery check, shall be carried out by the service personnel only. Contact your service personnel if any maintenance is required. Make sure to clean and disinfect the equipment before any test and maintenance.

Check/Maintenance Item		Recommended Frequency
Visual inspection		When first installed or reinstalled.
Power-on test		<ol style="list-style-type: none"> When first installed or reinstalled. Following any repairs or replacement of relevant component.
ECG verification	Performance test	<ol style="list-style-type: none"> If the user suspects that the measurement is incorrect. Following any repairs or replacement of relevant module. Once every two years. Note: NIBP test should be performed at least once a year.
	Verification	
Resp test	Performance test	
SpO ₂ test		
NIBP test	Pressure check	
	Leakage test	
Nurse call test		If the user suspects that the nurse call functionality does not work properly.
Electrical safety tests		<ol style="list-style-type: none"> After the TD60/TM80 or central charger falls off. At least once every two years or as needed
Network print test		<ol style="list-style-type: none"> When first installed. Whenever the printer is serviced or replaced.
Battery check	Functionality test	<ol style="list-style-type: none"> When first installed. Whenever the battery is replaced.
	Performance test	For rechargeable lithium-ion battery: once every two months or when the battery run time is reduced significantly.

16.5 Power-on Test

The TD60/TM80 performs a self-test during startup. You can refer to "Powering On the Unit" on page 3 - 9 for details.

16.6 Verifying the ECG at the TD60/TM80

The ECG signal may be inaccurate due to hardware or software problems. As a result, the ECG wave amplitude becomes greater or smaller. To verify the ECG waveform amplitude:

1. In the main menu, tap **Parameter Setup**.
2. Tap **ECG** and set **Filter** to **Monitor**.
3. In the main menu, tap **Maintenance**.
4. Input the maintenance passcode and tap **Accept**.
5. In the **Maintenance** menu, tap **General**.
6. Enable **Calibrate ECG**.
A square wave appears on the screen and the message **ECG Calibrating** is displayed.
7. Compare the amplitude of the square wave with the wave scale. The difference should be within 5%. If the difference exceeds 5%, contact your service personnel.
8. After completing the verification, disable **Calibrate ECG**.

16.7 NIBP Accuracy Test

The NIBP accuracy test is required at least once a year or when you doubt the measured NIBP result. Contact your service personnel to perform NIBP accuracy test.

16.8 NIBP Leakage Test

The NIBP leakage test checks the integrity of the system and of the valve. It is required at least once a year or when you doubt the measured NIBP result. Contact your service personnel to perform NIBP leakage test.

16.9 Nurse Call Test

The nurse call test checks whether this functionality can work properly. Contact your service personnel to perform the nurse call test.

16.10 Electrical Safety Tests

The electrical safety tests aim to detect abnormalities that, if undetected, could prove dangerous to either the patient or the operator. Contact your service personnel to perform the electrical safety tests.

16.11 Battery Check

For details about the battery charge check and maintenance, refer to ***Maintaining the Rechargeable Lithium-ion Battery*** on ***Page 13-7***.

16.12 Viewing System Information

To view the system information of the TD60/TM80, such as battery, tap **System Info** from the main menu.

17 Accessories

ECG Accessories.....	17-2
SpO2 Accessories.....	17-4
NIBP Accessories.....	17-5
Miscellaneous.....	17-5

The accessories listed in this chapter comply with the requirements of IEC 60601-1-2 when in use with the device. The accessory material that contacts the patients has undertaken the bio-compatibility test and is verified to be in compliance with ISO 10993-1. For details about the accessories, refer to the instructions for use provided with the accessory.

WARNING

- **Use accessories specified in this chapter. Using other accessories may cause damage to the monitor or not meet the claimed specifications.**
 - **Single-use accessories are not designed to be reused. Reuse may cause a risk of contamination and affect the measurement accuracy.**
 - **Check the accessories and their packages for any sign of damage. Do not use them if any damage is detected.**
 - **Use the accessories before the expiry date if indicated.**
 - **The disposable accessories shall be disposed of according to the hospital's regulations.**
-
-

17.1 ECG Accessories

17.1.1 ECG Electrodes

PN	Description	Applicable property	Applicable patient
0010-10-12304	Adult Electrode (Kendall, package of 10)	Disposable	Adult
9000-10-07469	Pediatric ECG electrode (3M, package of 50)	Disposable	Pediatric

17.1.2 ECG Leadsets

3-Lead

PN	Description	Applicable property	Applicable patient
009-004765-00	3-Lead, New Telemetry, AHA, Snap, 24"	Reusable	Adult, Pediatric
009-004766-00	3-Lead, New Telemetry, AHA, Snap, 36"		
009-004771-00	3-Lead, New Telemetry, AHA, Pinch, 24"		
009-004772-00	3-Lead, New Telemetry, AHA, Pinch, 36"		
115-032954-00	3-Lead, New Telemetry, Disp, AHA, Snap, 24" (20/box)	Disposable	

5-Lead

PN	Description	Applicable property	Applicable patient
009-004782-00	5-Lead, New Telemetry, AHA, Snap, 24"	Reusable	Adult, Pediatric
009-004783-00	5-Lead, New Telemetry, AHA, Snap, 36"		
009-004786-00	5-Lead, New Telemetry, AHA, Pinch, 24"		
009-004787-00	5-Lead, New Telemetry, AHA, Pinch, 36"		
115-032955-00	5-Lead, New Telemetry, AHA, Snap, 24" (20/box)	Disposable	

6-Lead (for the TM80 only)

PN	Description	Applicable property	Applicable patient
009-004794-00	6-Lead, New Telemetry, AHA, Snap, 24"	Reusable	Adult, Pediatric
009-004795-00	6-Lead, New Telemetry, AHA, Snap, 36"		
009-004798-00	6-Lead, New Telemetry, AHA, Pinch, 24"		
009-004799-00	6-Lead, New Telemetry, AHA, Pinch, 36"		

17.2 SpO₂ Accessories

The SpO₂ sensor material that contacts patients or other staff has undertaken the biocompatibility test and is verified to be in compliance with ISO 10993-1.

17.2.1 Masimo SpO₂ Module

PN	Description	Applicable property	Applicable patient
009-004936-00	Masimo SpO2 module (SET uSpO2)	Reusable	Adult, Pediatric

17.2.2 Masimo SpO₂ Sensor

PN	Description	Applicable property	Applicable patient
0600-00-0121	LNCS Adtx-Adult Single Patient Adhesive Sensors, >30 kg (20/box)	Disposable	Adult
0600-00-0122	LNCS Pdtx-Pediatric Single Patient Adhesive Sensors, 10-50 kg (20/box)		Pediatric
0600-00-0126	LNCS DCI Adult Reusable Finger Sensor, >30 kg	Reusable	Adult
0600-00-0127	LNCS DCIP Pediatric Reusable Finger Sensor, 10-50 kg		Pediatric

Wavelength emitted by the sensors is between 600 nm and 1000 nm. The maximum photic output consumption of the sensor is less than 18 mW.

The information about the wavelength range and maximum photic output consumption can be especially useful to clinicians (for example, when photodynamic therapy is performed).

17.2.3 Nonin SpO₂ Module

PN	Description	Applicable property	Applicable patient
009-004935-00	Nonin SpO2 module (XPOD 3012LP)	Reusable	Adult, Pediatric

17.2.4 Nonin SpO₂ Sensor

PN	Description	Applicable property	Applicable patient
0600-00-0139-24	Sensor, SpO ₂ (Nonin), Disp (24)	Disposable	Adult
100-000077-00	Nonin 8000AA Reusable SpO ₂ Sensor	Reusable	
100-000134-00	standard pediatric clip sensor	Reusable	Pediatric
100-000135-00	pediatric disp. sensor 24 pcs/box	Disposable	

17.3 NIBP Accessories

For NIBP accessories, refer to **BP10 NIBP Module Operator's Manual (P/N 046-011008-00)**.

17.4 Miscellaneous

PN	Description
022-000196-00	Li-ion battery 3.8V 3800mAh
0000-10-10902	Alkaline 1.5 V AA battery (for service personnel to perform debugging only)
0146-00-0077-10	L91 AA battery
045-001698-00	TP-2AA battery tray
045-001699-01	TP-3AA battery tray
115-032957-00	Disposable pouch (25/box)

PN	Description
DA8K-10-14452	US power cord
009-005409-00	USB upgrade cable
115-026852-00	Main unit of the central charger

A

Product Specifications

Classifications.....	A-2
Environmental Specifications.....	A-3
Power Supply Specifications.....	A-3
Physical Specifications.....	A-5
Hardware Specifications.....	A-5
Wireless Specification.....	A-7
Measurement Specifications.....	A-9

This chapter provides specifications of the TD60, RC60, central charger, and TM80. For specifications of BP10, refer to **BP10 NIBP Module Operator's Manual (P/N 046-011008-00)**.

A.1 Classifications

The device is classified as follows according to IEC60601-1:

Type of protection against electrical shock	TD60/TM80: class I, energized from an internal electrical power source. RC60: class I. Central Charger: class I.
Degree of protection against electrical shock for the TD60	Type CF defibrillation proof for ECG, and SpO ₂ .
Mode of operation	Continuous
Degree of protection against harmful ingress of water	TD60/TM80: IPX7 RC60: IPX0 Central Charger: IPX0
Degree of protection against hazards of explosion	Not suitable: Equipment not suitable for use in the presence of a flammable anesthetic mixture with air with oxygen or nitrous oxide.
Degree of protection against hazard of dropping for the TD60/TM80	No damage by dropping from a height of 1.5 m.

A.2 Environmental Specifications

WARNING

- **The devices may not meet the performance specifications if stored or used outside the specified temperature and humidity ranges.**

Item	Operating conditions	Storage conditions
Temperature	0 °C to 40 °C	-20 °C to 60 °C
Relative humidity (noncondensing)	15% to 95%	10% to 95%
Barometric	427.5 mmHg to 805.5 mmHg, or 57.0 kPa to 107.4 kPa	120 mmHg to 805.5 mmHg, or 16.0 kPa to 107.4 kPa

A.3 Power Supply Specifications

A.3.1 TD60/TM80

The battery life listed below may be shortened by the following factors:

- Wireless signal interference
- Aging battery
- Frequent operation of turning on/off the TM80 display
- Wireless network coverage which does not meet the technical specifications in

Battery type	AA batteries (two or three for the TD60; three for the TM80) Rechargeable lithium-ion battery (one)
Capacity for lithium-ion battery	≥ 3500 mAh
Charge time for lithium-ion battery	At the room temperature: ≤ 5 hours to 90% charge
Safety and authentication for lithium-ion battery	UL2054, IEC62133, UN38.3

Battery run time (at 25 °C ±5 °C, with display off, no sound and light as default, no alarms, display lit for one minute every two hours, using L91 AA batteries (PN 0146-00-0077-10))			Two AA batteries	Three AA batteries	Lithium-ion battery
	TD60	5-lead ECG:	≥ 72 hours	≥ 120 hours	≥ 110 hours
		5-lead ECG + SpO ₂	≥ 40 hours	≥ 84 hours	≥ 80 hours
	TM80	5-lead ECG	/	≥36 hours	≥36 hours
5-lead ECG+SpO ₂		/	≥28 hours	≥28 hours	
Shutdown delay	at least 10 minutes after the low battery alarm first occurs. at least five minutes after the critically low battery alarm first occurs.				

A.3.2 RC60

The telemetry receiver is powered by external AC power.

Input voltage	100 to 240 VAC (± 10%)
Frequency	50 Hz/60 Hz (± 3 Hz)
Input current	0.6 A to 0.3 A

A.3.3 Central Charger

The central charger is powered by external AC power.

Input voltage	100 VAC to 240 VAC (± 10%)
Frequency	50 Hz/60 Hz (±3 Hz)
Input current	1.5 A to 0.75 A
Charge time	At the room temperature: ≤ 5 hours to 90% charge
Overcharge protection function	The charger automatically stops charging when the lithium-ion battery charge is full.

A.4 Physical Specifications

	Size	Weight
TD60	126 mm × 64 mm × 23 mm	< 140 g (without batteries, SpO ₂ module, ECG leadwires, or accessories)
		210 g (with two AA batteries and 3-lead ECG cable, without the SpO ₂ module and any other accessories)
TM80		< 140 g (without batteries, SpO ₂ module, ECG leadwires, or accessories)
		229g (with a rechargeable lithium-ion battery, without SpO ₂ module, ECG leadwires, or accessories)
		233g (with three AA batteries, without SpO ₂ module, ECG leadwires, or accessories)
RC60	120 mm × 300 mm × 350 mm	7000 g
Central charger	365 mm × 171 mm × 78 mm (without batteries and wall-mount bracket)	1130 g (without batteries and wall-mount bracket)

A.5 Hardware Specifications

A.5.1 TD60/TM80

Display	
Screen type	Color TFT LCD screen
Screen size	3.5"
Resolution	480 pixels × 320 pixels
Display Activation (Power On/Off) key	The switch time is less than or equal to two seconds.
LED	
Alarm lamp	1 (three colors: red, yellow, and cyan)
Audio Indicator	

Speaker	1
Sound Pressure Range	45 dBA to 85 dBA
Keys	
Nurse call	1
Power On/Off	1
Main menu	1
External Connectors	
ECG connector	1
SpO₂ connector	1

A.5.2 RC60

LED	
Communications indicator	1 (green), indicates the ready and communications status.
Power indicator	1 (green), indicates the power status.
Audio Indicator	
Buzzer	1, indicates internal abnormality.
External Connectors	
Ethernet connector	1, standard RJ45 connector
Antenna connector	2

A.5.3 Central Charger

Charger slot	10
LED	10, which indicates the battery charge status.
AC power indicator	1
Installation mode	Place on the desktop, or mount on GCX® wall channel.

A.6 Wireless Specification

A.6.1 WMTS Specification for the TD60

A.6.1.1 Technical Specification

Protocol	Private protocol
Modulation mode	GFSK
Operating frequency band	608 MHz to 614 MHz
Channel spacing	25 KHz
Wireless baud rate	8 kbps \pm 3%
Transmit power	< 10 mW
Receiver sensitivity	\leq -110 dBm (Bit error rate \leq 1%)
Data security	Private protocol

A.6.1.2 Implemented Functions

The TD60 transmitters send waveforms, parameters, status and technical alarms of ECG, SpO₂, RESP, NIBP to the CMS through the path of active Antenna Array or passive Antenna Array and receiver box. The receiver box can measure RSSI from TD60 and send it to the CMS.

A.6.1.3 Function Specification

WARNING

- **Do perform all network functions of data communication within an enclosed network.**

Data integrity	Bit error rate $\leq 1\%$
Data delay	Total delay of data transmission from the transmitter to the CMS: ≤ 3 seconds
Priority	All communication data type have the same priority.
Transmission distance	Distinct vision distance between the transmitter and the receiver antenna is greater than or equal to 50 m.
Receiver capacity	16 beds
System capacity	32 beds
Dynamic networking stability	The wireless functions of the TD60 are normal while the transmitter is moving at the rate of no more than 3.75 m/s within the wireless transmission distance.
Resistance to wireless interference	<p>The wireless functions of the transmitter are normal when the following conditions exist simultaneously:</p> <ul style="list-style-type: none"> ■ The distance between interfering devices and the transmitter is greater than 20 centimeters. ■ The distance between interfering devices and the receiver antenna is greater than 100 centimeters. ■ -118dBm co-channel WMTS interference exists at the receiver antenna. <p>Note: The interfering devices include but are not limited to wireless devices operated at 2.4GHz, cellular mobile communication network devices, microwave ovens, and cordless phones.</p>
Communication interruption alarm	After the communication between the TD60 and the receiver is interrupted, the CMS issues an alarm within eight seconds.
Signal strength detection	RSSI detection scope: -110 dBm to -80 dBm Accuracy: ± 2 dB

A.6.2 Mindray Patient Area Network (MPAN) Specification (For the TD60/TM80)

A.6.2.1 Technical Specification

Protocol standard	Bluetooth low energy 4.0
Modulation mode	GFSK
Operating frequency	2402 MHz to 2480 MHz
Channel spacing	2 MHz
Wireless baud rate	1 Mbps
Output power	≤ 2.5 mW
Data Security	Private protocol

A.6.2.2 Implemented Function

This function is provided to transfer configuration information between the TD60/TM80 and to perform communication between a TD60/TM80 and a BP10.

BP10 transmits NIBP parameters, status, and prompt messages to the TD60/TM80. The TD60/TM80 transmits control information and settings information to the BP10.

A.6.2.3 Function Specification

Data integrity	Code error rate ≤ 1%
Data latency	Total delay of data transmission from BP10 to the TD60/TM80 or from the TD60/TM80 to BP10: ≤ 3 second Total delay of data transmission from the TD60/TM80 to the CMS: ≤ 3 second
Priority	All communication data type shall have the same priority.
Transmission distance	Distinct vision distance between the TD60s/TM80s is no less than 3 m Distinct vision distance between the TD60s/TM80s and the BP10 is no less than 3 m.

System capacity	One TD60/TM80 can synchronously transport the device configuration to at least other five the TD60s/TM80s in a 10 m ² space. Five pairs of the TD60s/TM80s and BP10s can communicate in a 10 m ² space, with the TD60/TM80 communicating with the CMS.
Resistance to wireless interference	The bluetooth function is normal when the distance between the following interfering devices and the TD60/TM80 or BP10 are as follows: <ul style="list-style-type: none"> ■ > 1 m for microwave ovens. ■ > 0.2 m for cellular communication devices, Wi-Fi devices, intercoms, and cordless phones.
Communication interruption message	When the bluetooth communication is interrupted, the TD60/TM80 displays a prompt message.

A.6.3 Wi-Fi Specifications (For the TM80 Only)

A.6.3.1 Technical Specifications

Protocol	IEEE 802.11 a/b/g/n/ac
Modulation mode	DSSS and OFDM
Operating frequency	2412 MHz to 2472 MHz 5180 MHz to 5825 MHz
Channel spacing	IEEE 802.11 b/g/n (at 2.4G): 5 MHz IEEE802.11 a/n/ac (at 5G): 20 MHz
Wireless baud rate (data rate)	IEEE 802.11b: 1M Mbps to 11M Mbps IEEE 802.11a/g: 6 M Mbps to 54M Mbps IEEE 802.11n: MCS0 to MCS7 IEEE 802.11ac: MCS0 to MCS8
Output power (transfer power)	< 20 dBm (CE requirement: detection mode – RMS) < 30 dBm (FCC requirement: detection mode – peak power)
Operating mode	Infrastructure
Data security	Standards: WPA/ WPA2 PSK, WPA/WPA2 EAP, WPA/WPA2 CCKM EAP methods: LEAP, TTLS, TLS, FAST, PEAP-MSChapV2, PEAP-GTC, PEAP-TLS Encryption modes: TKIP and AES
QoS	QoS setting supported

A.6.3.2 Implemented Functions

TM80 transmits waveforms, parameters, status and technical alarms of ECG, SpO₂, RESP; and parameters, status and technical alarms of NIBP to the CMS. The waveforms, parameters, status and technique alarms displayed on the CMS are consistent with TM80.

TM80 can work well with APs which support POE (e.g. AIR-AP2802I-H-K9, working with AC: AIR-CT2504-15-K9), if the RSSI from APs is higher than -65 dbm.

A.6.3.3 Function Specifications

WARNING

- **Do perform all network functions of data communication within an enclosed network.**

Data integrity	The ratio of the communication data lost on center station from TM80 is less than 0.1% in 24 hours.
Data latency	Total delay of data transmission from the TM80 Telemetry Monitor to the CMS: ≤ 3 seconds.
Priority	All communication data types shall have the same priority.
Transmission distance	Distinct vision distance between the TM80 and the AP is no less than 50 m.
Roaming	The network switchover is automatically implemented when TM80 moves from the coverage area of AP1 to the coverage area of AP2, no network interruption alarm event will occur.
System capacity	Number of the TM80s supported by a single AP: ≤ 16; Each TM80 can communicate with the CMS.
Dynamic networking stability	When a TM80 is moving at the rate of no more than 3.75 m/s within a 15m non-blocking linear distance, it does not encounter a network interruption alarm event.
Resistance to wireless interference	When the distance between the interfering devices and the TM80 is greater than 20 cm, and a co-channel interference Wi-Fi network (should be no greater than -85dBm) and an adjacent-channel Wi-Fi network (should be no greater than -50 dBm) synchronously exist, the TM80 does not encounter a network interruption alarm event. Note: the interfering devices includes: <ul style="list-style-type: none"> • Cellular communication devices • Microwave ovens • Intercoms • Cordless phones • Bluetooth devices

Network interruption alarm	<ol style="list-style-type: none"> 1. When the network interruption occurs, the CMS issues related alarms in 12 seconds. 2. When the network is reconnected, wireless connection recovers automatically.
Wireless networking stability	<p>The ratio of the communication data lost on center station from TM80 is less than 0.1% in 24 hours under the following circumstances:</p> <ul style="list-style-type: none"> ■ When 16 TM80s are connected to one AP, ■ Each of the 16 TM80s roam 30 times, and ■ At least 3 TM80s roam simultaneously

A.7 Measurement Specifications

A.7.1 ECG

ECG	
Standard	Meet standards of IEC60601-2-27 and IEC60601-2-25
Leadset	For the TD60: 3-lead: I, II, III 5-lead: I, II, III, aVR, aVL, aVF, V Automatic 3/5 lead recognition
	For the TM80: 3-lead: I, II, III 5-lead: I, II, III, aVR, aVL, aVF, V 6-lead: I, II, III, aVR, aVL, aVF, Va, Vb Automatic 3/5/6- lead recognition
ECG standard	AHA, IEC
Sweep speed	6.25 mm/s, 12.5 mm/s, 25 mm/s Accuracy: ± 10%
Display Sensitivity	1.25 mm/mV (×0.125), 2.5 mm/mV (×0.25), 5 mm/mV (×0.5), 10 mm/mV (×1), 20 mm/mV (×2), 40 mm/mV (×4) Accuracy: ± 5%
Input signal range	±8 mV (peak-to-peak value)
Calibration signal	1 mV (peak-to-peak value) Accuracy: ± 5%
Differential input impedance	≥ 5 MΩ

Bandwidth (-3dB)	Monitor mode: 0.5 Hz to 40 Hz ST mode: 0.05 Hz to 40 Hz
Common mode rejection ratio (with Notch off)	> 105 dB
Notch	50/60 Hz, rejection capacity ≥ 20 dB
Polarizing voltage scope	± 500 mV
Noise	≤ 30 μV (p-v RTI)
Baseline recovery time	< 5 s (after defibrillation)
Direct current leakage	Input electrode: < 0.1 μA Drive electrode: < 1 μA
Electrode polarization recovery time	< 10 s
Defibrillation energy absorption	≤ 10% (100 Ω load)
Pace Pulse	
Pace pulse markers	Pace pulses meeting the following conditions are labelled with a PACE marker: Amplitude: ±2 mV to ±700 mV Width: 0.1 ms to 2 ms Rise time: 10 μs to 100 μs Amplitude: ≥ 0.2mV RTI
Pace pulse rejection	When tested in accordance with the IEC60601-2-27:2011.12.1.101.13, the heart rate meter rejects all pulses meeting the following conditions. Amplitude: ±2 mV to ±700 mV Width: 0.1 ms to 2 ms Rise time: 10 μs to 100 μs No overshoot About 50% pulse of ANSI/AAMI EC13 (5d) can trigger the pulse detector, the least changing rate is 20 V/s RTI.
HR	
Measurement range	Adult: 0, 15 bpm to 300 bpm Pediatric: 15 bpm to 350 bpm
Resolution	1 bpm
Accuracy	± 1 bpm or ± 1%, whichever is greater.

Sensitivity	Advanced ECG Algorithm	Standard ECG Algorithm
		200 μ V
HR averaging method	Advanced ECG Algorithm	Standard ECG Algorithm
	<p>In compliance with the requirements in Clause 201.7.9.2.9.101 b) 3) of IEC60601-2-27, the following method is used:</p> <p>If the last 3 consecutive RR intervals are greater than 1200 ms, the 4 most recent RR intervals are averaged to compute the HR. Otherwise, heart rate is computed by subtracting the maximum and minimum ones from the most recent 12 RR intervals and then averaging them.</p> <p>The HR value displayed on the monitor screen is updated every second.</p>	<p>In compliance with the requirements in Clause 201.7.9.2.9.101 b) 3) of IEC60601-2-27, the following method is used:</p> <p>Heart rate is computed by averaging the most recent 16 RR intervals, unless the HR by averaging the most recent 4 heart beats is less than or equal to 48 bpm.</p> <p>The HR value displayed on the monitor screen is updated every second.</p>
Tall T-wave rejection capability	<p>When the test is performed based on Clause 201.7.9.2.9.101 b) 2) of IEC60601-2-27, the heart rate meter will reject all 100 ms QRS complexes with less than 1.2 mV of amplitude, and T waves with T-wave interval of 180 ms and those with Q-T interval of 350 ms.</p>	
Response time to heart rate change	<p>Meets the requirements of IEC60601-2-27: Clause 201.7.9.2.9.101 b) 5).</p> <p>From 80 bpm to 120 bpm: less than 11 s</p> <p>From 80 bpm to 40 bpm: less than 11 s</p>	
Response to irregular rhythm	<p>In compliance with the requirements in Clause 201.7.9.2.9.101 b) 4) of IEC60601-2-27, the heart rate after 20 seconds of stabilization is displayed as follows:</p> <p>Ventricular bigeminy (3a): 80 ± 1 bpm</p> <p>Slow alternating ventricular bigeminy (3b): 60 ± 1 bpm</p> <p>Rapid alternating ventricular bigeminy (3c): 120 ± 1 bpm</p> <p>Bidirectional systoles (3d): 90 ± 2 bpm</p>	
Time to alarm for tachycardia	<p>Meets the requirements of IEC60601-2-27: Clause 201.7.9.2.9.101 b) 6).</p> <p>Waveform</p> <p>4ah - range: < 11 s</p> <p>4a - range: < 11 s</p> <p>4ad - range: < 11 s</p> <p>4bh - range: < 11 s</p> <p>4b - range: < 11 s</p> <p>4bd - range: < 11 s</p>	
ST Segment Analysis		

Measurement range	-2.0 mV to +2.0 mV RTI	
Resolution	0.01 mV	
Accuracy	-0.8 mV to +0.8 mV: ± 0.02 mV or $\pm 10\%$, whichever is greater Beyond this range: Not specified	
Arrhythmia Analysis		
Arrhythmia analysis classifications	Advanced ECG Algorithm	Standard ECG Algorithm
	Asystole, VFib/VTac, Vtac, Vent. Brady, Extreme Tachy, Extreme Brady, PVCs/min, Pauses/min, R on T, Run PVCs, Couplet, Multif. PVC, PVC, Bigeminy, Trigeminy, Tachy, Brady, Pacer Not Pacing, Pacer Not Capture, Missed Beat, Nonsus. Vtac, Vent. Rhythm, Pause, Irr.Rhythm, Afib	Asystole, VFib, Vtac, Extreme Tachy, Extreme Brady, PVCs/min, Pauses/min, R on T, Run PVCs, Couplet, Multif. PVC, Bigeminy, Trigeminy, Tachy, Brady, Pacer Not Pacing, Pacer Not Capture, Vent. Rhythm, Pause, Irr.Rhythm
QT Analysis		
QTc formula	Bazett, Fridericia, Framingham, and Hodges	
	Advanced ECG Algorithm	Standard ECG Algorithm
QT measurement range	200, 800 ms	300, 600 ms
QT accuracy	200, 800 ms: ± 30 ms Beyond this range: Not specified	300, 600 ms: ± 30 ms Beyond this range: Not specified
QT resolution	200, 800 ms: 4 ms Beyond this range: Not specified	300, 600 ms: 2 ms Beyond this range: Not specified
QTc measurement range	200, 800 ms	300, 600 ms
QTc resolution	200, 800 ms: 1 ms Beyond this range: Not specified	300, 600 ms: 1 ms Beyond this range: Not specified
QT-HR measurement range	Adult: 15, 150 bpm Pediatric: 15, 180 bpm	N/A

A.7.2 Resp

Resp	
Technique	Trans-thoracic impedance
Lead	Lead II
Respiration excitation waveform	<300uARMS, 32kHz(±10%)
Baseline impedance range	200Ω to 2500Ω
Bandwidth	0.2 Hz to 2.5 Hz (-3 dB)
Sweep speed	3mm/s, 6.25 mm/s, 12.5 mm/s, 25 mm/s
Respiration Rate	
Measurement range	Adult: 0 rpm to 120 rpm Pediatric: 0 rpm to 150 rpm
Resolution	1 rpm
Accuracy	7 rpm to 150 rpm: ±2 rpm or ±2%, whichever is greater 0 rpm to 6 rpm: Not specified
NCM alarm delay	10s, 15s, 20s, 25s, 30s, 35s, 40s

A.7.3 SpO₂

NOTE

- **A functional tester or SpO₂ simulator can be used to determine the pulse rate accuracy.**

A.7.3.1 Nonin SpO₂ Module

SpO ₂	
Measurement range	0% to 100%
Resolution	1%
Accuracy	70-100%: ±3 digits 0-69%: Not specified
Data update rate	≤2s
<p>*Studies were performed to validate the accuracy of Pulse Oximeter with Nonin SpO₂ sensors by contrast with a CO-Oximeter. In total, 12 adults (7 male & 5 female) aged from 19 to 35 years old were voluntarily involved in this study. Five are Caucasian, two are Indian, three are Asian, and two are African-American. All of them conform the clinical study requirements for age, gender, skin and health.</p>	
<p>The following table shows the accuracy (A_{rms}) for the SpO₂ sensors in four kinds of SaO₂ ranges. For the Fitting Curve of the SpO₂ sensors, refer to the "Fitting Curve for Nonin SpO₂ Sensors" on page A - 18.</p>	
SaO ₂ range	Measured A _{rms} Value (7000A, 7000P, 8000AA, 8000AP)
70% to 100%	1.54
70% to 80%	1.41
80% to 90%	1.97
90% to 100%	1.28
PR	
Measurement range	20 bpm to 300 pm
Resolution	1 bpm

Accuracy	±3 bpm
Response Time	
■	≤ 25 s (PR 75 bpm, average time 4 heart beats, no disturbance, SpO ₂ value rises from 70% to 100%)
■	≤ 35 s (SpO ₂ value 98%, average time 4 heart beats, no disturbance, PR value rises from 60 bpm to 150 bpm)

A.7.3.2 Fitting Curve for Nonin SpO₂ Sensors

7000A, 7000P, 8000AA, 8000AP

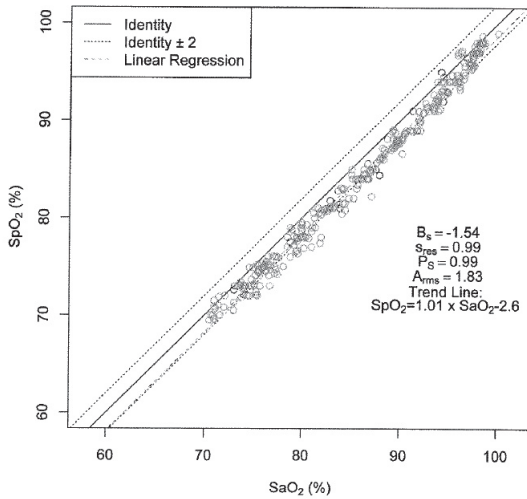

$$SpO_2 = 1.01 \times SaO_2 - 2.6$$

Scatter Plot of the SpO₂ versus the SaO₂

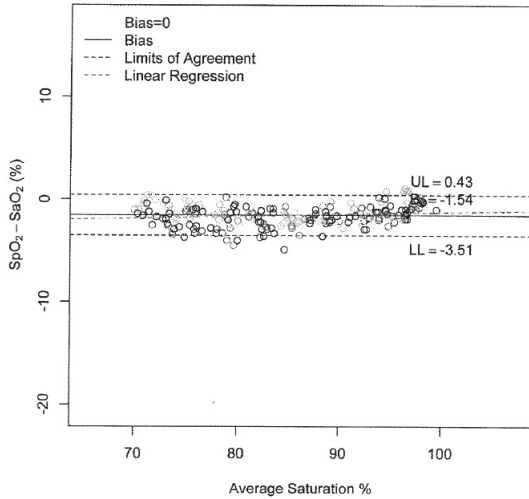

Bland-Altman Plots of the Bias versus the Mean

A.7.3.3 Masimo SpO₂ Module

SpO ₂	
Measurement range	1% to 100%
Resolution	1%
Accuracy*	70-100%: ±2.0% (measured without motion) 70-100%: ±3.0% (measured with motion) 1-69%: Not specified
Low Perfusion Conditions	Pulse amplitude: > 0.02% Light penetration: > 5% Accuracy: ±2%
Data update rate	≤2s
*SpO ₂ accuracy was determined by testing on healthy adult volunteers in the range of 60% to 100% SpO ₂ against a laboratory CO-Oximeter. SpO ₂ accuracy was determined on 16 neonatal NICU patients ranging in age from 7-135 days old and weighing between 0.5-4.25 kg. Seventy-nine (79) data samples were collected over range of 70-100% SaO ₂ with a resultant accuracy of 2.9% SpO ₂ .	
The following table shows the accuracy (A _{rms}) for the SpO ₂ sensors in four kinds of SaO ₂ ranges. For the Fitting Curve of the SpO ₂ sensors, refer to the "Fitting Curve for Masimo SpO₂ Sensors" on page A - 21.	

SaO ₂ range	Measured A _{rms} Values	
	LNCS Adtx, LNCS Pdtx	LNCS DCI, LNCS DCIP
70% to 100%	± 2%	2%
70% to 80%	1.55%	0.60%
80% to 90%	1.07%	0.54%
90% to 100%	1.64%	0.60%
PR		
Measurement range	25 bpm to 240 bpm	
Resolution	1 bpm	
Accuracy	±3.0 bpm (measured without motion) ±5.0 bpm (measured with motion)	
PI		
Measurement range	0.02% to 20%	
Least resolution	0.01, use three valid digits	
Response Time		
<ul style="list-style-type: none"> ■ ≤ 25 s (PR 75 bpm, average time 8 s, no disturbance, SpO₂ value rises from 50% to 100%) ■ ≤ 20 s (SpO₂ value 98%, average time 8 s, no disturbance, PR value rises from 60 bpm to 150 bpm) 		

A.7.3.4 Fitting Curve for Masimo SpO₂ Sensors

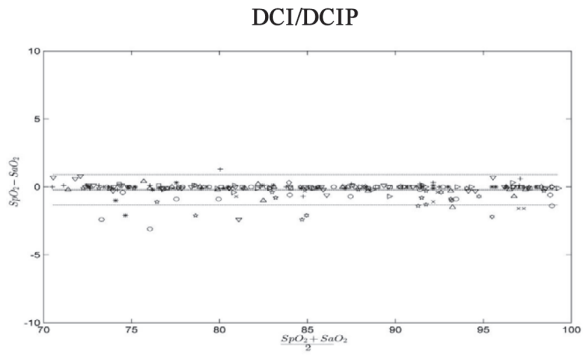

This page intentionally left blank.

B EMC

The TMS60 telemetry monitoring system and TM80 telemetry monitor meet the requirements of IEC 60601-1-2: 2014.

WARNING

- Use of accessories, transducers and cables other than those specified or provided by the manufacturer of this device could result in increased electromagnetic emissions or decreased electromagnetic immunity of this device and result in improper operation. Use of this device adjacent to or stacked with other device should be avoided because it could result in improper operation. If such use is necessary, this device and the other device should be observed to verify that they are operating normally. Portable RF communications equipment (including peripherals such as antenna cables and external antennas) should be used no closer than 30 cm (12 inches) to any part of the this device, including cables specified by the manufacturer. Otherwise, degradation of the performance of this device could result. The non-ME EQUIPMENT (e.g. ITE) that is a part of an ME SYSTEM may be disrupted by the electromagnetic interference of nearby equipment. It may be necessary to take mitigation measures, such as re-orienting or relocating the non-ME EQUIPMENT or shielding the location. This device is intended for use in professional healthcare facility environment. If it is used in special environment, such as magnetic resonance imaging environment, the equipment/system may be disrupted by the operation of nearby equipment.**

Guidance and Declaration — Electromagnetic Emissions		
The device is intended for use in the electromagnetic environment specified below. The customer or the user of the device should assure that it is used in such an environment.		
Emissions test	Compliance	Electromagnetic environment — guidance
RF emissions CISPR 11	Group 1	The system uses RF energy only for its internal function. Therefore, its RF emissions are very low and are not likely to cause any interference in nearby electronic equipment.
RF emissions CISPR 11	Class B*	Only TM80 Telemetry Monitor and BP10 (subpart) compliance. The devices are suitable for use in all establishments, including domestic establishments and those directly connected to the public low voltage power supply network that supplies buildings used for domestic purposes.

RF emissions CISPR 11	Class A	The system is suitable for use in all establishments other than domestic and those directly connected to the public low-voltage power supply network that supplies buildings used for domestic purposes.
Harmonic Emissions IEC61000-3-2	Class A	
Voltage Fluctuations/Flicker Emissions IEC 61000-3-3	Complies	
Note: The TM80 Telemetry Monitor and BP10 (subpart) are classified by is their using environment or intended function.		

NOTE

- **The device needs special precautions regarding EMC and needs to be installed and put into service according to the EMC information provided below.**
 - **Other devices may affect this device even though they meet the requirements of CISPR.**
 - **When the inputted signal is below the minimum amplitude provided in technical specifications, erroneous measurements could result.**
-

NOTE

- **The EMISSIONS characteristics of this device make it suitable for use in industrial areas and hospitals (CISPR 11 class A). If it is used in a residential environment (for which CISPR 11 class B is normally required) this device might not offer adequate protection to radio-frequency communication services. The user might need to take mitigation measures, such as relocating or re-orienting the device.**
- **If the essential performance is lost or degraded, it may be necessary to take mitigation measures, such as re-orienting or relocating the ME EQUIPMENT or ME SYSTEM or shielding the location or stopping using the monitor and contact the service personnel.**

If the system is operated within the electromagnetic environment listed in Table Guidance and declaration - electromagnetic immunity, the system will remain safe and provide the following essential performance:

- Operating mode
- Accuracy
- Function
- Accessories identification
- Data stored
- Alarm
- Detect for connection

Guidance and Declaration — Electromagnetic Immunity

The device is intended for use in the electromagnetic environment specified below. The customer or the user of the device should assure that it is used in such an environment.

Immunity test	IEC 60601 test level	Compliance level	Electromagnetic environment - guidance
Electrostatic discharge (ESD) IEC 61000-4-2	± 8 kV contact ± 15 kV air	± 8 kV contact ± 15 kV air	Floors should be wood, concrete or ceramic tile. If floors are covered with synthetic material, the relative humidity should be at least 30%.

Electrical fast transient/burst IEC 61000-4-4	± 2 kV for power supply lines ± 1 kV for input/output lines (length greater than 3 m)	± 2 kV for power supply lines ± 1 kV for input/output lines (length greater than 3 m)	Mains power quality should be that of a typical commercial or hospital environment.
Surge IEC 61000-4-5	± 1 kV line(s) to line(s) ± 2 kV line(s) to earth	± 1 kV line(s) to line(s) ± 2 kV line(s) to earth	
Voltage dips and Voltage interruptions IEC 61000-4-11	0 % U_T for 0,5 cycle 0 % U_T for 1 cycle and 70 % U_T for 25/30 cycles 0 % U_T for 250/300 cycle	0 % U_T for 0,5 cycle 0 % U_T for 1 cycle and 70 % U_T for 25/30 cycles 0 % U_T for 250/300 cycle	Mains power quality should be that of a typical commercial or hospital environment. If the user of our product requires continued operation during power mains interruptions, it is recommended that our product be powered from an uninterruptible power supply or a battery.
RATED power frequency magnetic fields IEC 61000-4-8	30 A/m 50 Hz / 60 Hz	30 A/m 50 Hz / 60 Hz	Power frequency magnetic fields should be at levels characteristic of a typical location in a typical commercial or hospital environment.
Note: U_T is the A.C. mains voltage prior to application of the test level.			

Guidance and Declaration — Electromagnetic Immunity			
The device is intended for use in the specified electromagnetic environment. The customer or the user of the device should assure that it is used in such an environment as described below.			
Immunity test	IEC 60601 Test level	Compliance level	Electromagnetic environment - guidance
Conducted disturbances induced by RF fields IEC61000-4-6	3 Vrms 150 kHz to 80 MHz	3 Vrms	Portable and mobile RF communications equipment should be used no closer to any part of the device, including cables, than the recommended separation distance calculated from the equation applicable to the frequency of the transmitter. Recommended separation distance: $d = \left[\frac{3.5}{V} \right] \sqrt{P} \quad 150\text{kHz to } 80 \text{ MHz}$
	6 Vrms in ISM bands and amateur radio bands between 0,15 MHz and 80 MHz	6 Vrms	
Radiated RF EM fields IEC61000-4-3	10V/m 80 MHz to 2.7 GHz	10V/m(Only TM80 and BP10)	$d = \left[\frac{3.5}{E} \right] \sqrt{P} \quad 80 \text{ MHz to } 800 \text{ MHz}$
Radiated RF EM fields IEC61000-4-3	3V/m 80 MHz to 2.7 GHz	3V/m(TM80 system)	$d = \left[\frac{7}{E} \right] \sqrt{P} \quad 800 \text{ MHz to } 2.7 \text{ GHz}$
Proximity fields from RF wireless communications equipment IEC61000-4-3	27 V/m 380-390 MHz	27 V/m	where P is the maximum output power rating of the transmitter in watts (W) according to the transmitter manufacturer and d is the recommended separation distance in meters (m). Field strengths from fixed RF transmitters, as determined by an electromagnetic site survey ^b , should be less than the compliance level in each frequency range ^c . Interference may occur in the vicinity of equipment marked with the following symbol: 
	28 V/m 430-470 MHz, 800-960 MHz, 1700-1990 MHz, 2400-2570 MHz	28 V/m	
	9 V/m 704-787 MHz, 5100-5800 MHz	9 V/m	
<p>Note 1: At 80 MHz and 800 MHz, the higher frequency range applies.</p> <p>Note 2: These guidelines may not apply in all situations. Electromagnetic propagation is affected by absorption and reflection from structures, objects and people.</p>			

^a: The ISM (industrial, scientific, and medical) bands between 150 kHz and 80 MHz are 6.765 MHz to 6.795 MHz; 13.553 MHz to 13.567 MHz; 26.957 MHz to 27.283 MHz; and 40.66 MHz to 40.70 MHz. The amateur radio bands between 0,15 MHz and 80 MHz are 1,8 MHz to 2,0 MHz, 3,5 MHz to 4,0 MHz, 5,3 MHz to 5,4 MHz, 7 MHz to 7,3 MHz, 10,1 MHz to 10,15 MHz, 14 MHz to 14,2 MHz, 18,07 MHz to 18,17 MHz, 21,0 MHz to 21,4 MHz, 24,89 MHz to 24,99 MHz, 28,0 MHz to 29,7 MHz and 50,0 MHz to 54,0 MHz.

^b: Field strengths from fixed transmitters, such as base stations for radio (cellular/cordless) telephones and land mobile radios, amateur radio, AM and FM radio broadcast and TV broadcast cannot be predicted theoretically with accuracy. To assess the electromagnetic environment due to fixed RF transmitters, an electromagnetic site survey should be considered. If the measured field strength in the location in which the device is used exceeds the applicable RF compliance level above, the device should be observed to verify normal operation. If abnormal performance is observed, additional measures may be necessary, such as re-orienting or relocating the device.

^c: Over the frequency ranges 150 kHz to 80 MHz, field strengths should be less than 3V/m.

Recommended Separation Distances between Portable and Mobile RF, Communications Equipment and This Equipment

The equipment is intended for use in an electromagnetic environment in which radiated RF disturbance are controlled. The customer or the user of the device can help prevent electromagnetic interference by maintaining a minimum distance between portable and mobile RF communications equipment (transmitters) and the device as recommended below, according to the maximum output power of the communication equipment.

Rated Maximum Output power of Transmitter Watts (W)	Separation Distance According to Frequency of Transmitter (m)		
	150kHz -80MHz $d = \left[\frac{3.5}{V} \right] \sqrt{P}$	80MHz to 800MHz $d = \left[\frac{3.5}{E} \right] \sqrt{P}$	800MHz to 2.7GHz $d = \left[\frac{7}{E} \right] \sqrt{P}$
0.01	0.12	0.12	0.23
0.1	0.38	0.38	0.73
1	1.2	1.2	2.3
10	3.8	3.8	7.3
100	12	12	23

For transmitters at a maximum output power not listed above, the recommended separation distanced in meters (m) can be determined using the equation applicable to the frequency of the transmitter, where P is the maximum output power rating of the transmitter in watts (W) according to the transmitter manufacturer.

Note 1: At 80 MHz and 800 MHz, the higher frequency range applies.

Note 2: These guidelines may not apply in all situations. Electromagnetic propagation is affected by absorption and reflection from structures, objects and people.

This page intentionally left blank.

C

FCC Compliance

The TMS60 telemetry monitoring system and TM80 telemetry monitor comply with the requirements of FCC Part 95:

Authorized health care providers, in conjunction with the equipment manufacturers, must cooperate in the selection and use of frequencies in order to reduce the potential for interference with other wireless medical telemetry devices, or other co-primary users. Operations in the 608–614 MHz band (television channel 37) are not protected from adjacent band interference from broadcast television operating on channels 36 and 38.

As the RF range of the system is 608-614Mhz, if located near the radio astronomy observatories the two parties will interfere with each other.

Therefore, we don't suggest that the equipment can be installed or operated within 80 kilometers of:

1. National Astronomy and Ionosphere Center, Arecibo, Puerto Rico: 18°20'38.28" North Latitude, 66°45'09.42" West Longitude.
2. National Radio Astronomy Observatory, Socorro, New Mexico: 34°04'43" North Latitude, 107°37'04" West Longitude.
3. National Radio Astronomy Observatory, Green Bank, West Virginia: 38°26'08" North Latitude, 79°49'42" West Longitude.

Radio frequency Radiation Exposure Information

For body worn operation, this equipment has been tested and meets the FCC and CE RF exposure guidelines when used with the accessories supplied or those approved for use with this product. Use of other accessories may not ensure compliance with FCC and CE RF exposure guidelines within 32 kilometers of the National Radio Astronomy Observatory centered on:

Very long baseline array stations	Latitude (north)	Longitude (west)
Pie Town, NM	34°18'	108°07'
Kitt Peak, AZ	31°57'	111°37'
Los Alamos, NM	35°47'	106°15'
Fort Davis, TX	30°38'	103°57'
North Liberty, IA	41°46'	91°34'
Brewster, WA	48°08'	119°41'
Owens Valley, CA	37°14'	118°17'
Saint Croix, VI	17°46'	64°35'
Mauna Kea, HI	19°49'	155°28'
Hancock, NH	42°56'	71°59'

If the installation distance is not enough, obtain the written concurrence of the Director of the affected radio astronomy station before the equipment can be installed or operated.

RF parameter (WMTS Module for TMS60 Only)

Type of Radio	WMTS
Operating frequency band	608 MHz to 614 MHz
Modulation mode	GFSK
Output power	<10 mW

RF parameter (Bluetooth Module for the TMS60/TM80) (Panlink2 Module)

Type of Radio	Bluetooth low energy 4.0
Operating frequency	2402 MHz to 2480 MHz
Modulation mode	GFSK
Output power	≤2.5 mW

RF parameter (Wi-Fi Module for the TM80 Only) (SX-SDMAC-2832S+)

Type of Radio	IEEE 802.11b/g/n (2.4G)	IEEE 802.11a/n (5G)
Modulation mode	DSSS and OFDM	OFDM
Operating frequency	2412 MHz to 2472 MHz	5180 MHz to 5825 MHz
Output power	< 30 dBm (Peak Power) < 20 dBm (Average Power)	

The device including Wireless module complies with part 15 of the FCC Rules. Operation is subject to the condition that this device does not cause harmful interference.



The radio device used in this product is in compliance with the essential requirements and other relevant provisions of Directive 2014/53/EU.

For body worn operation, this equipment has been tested and meets the CE RF exposure guidelines when used with the accessories supplied or those approved for use with this product. Use of other accessories may not ensure compliance with CE RF exposure guidelines.

This page intentionally left blank.

D Symbols and Abbreviations

Units.....	D-2
Symbols.....	D-3
Abbreviations.....	D-3

D.1 Units

A	ampere
Ah	ampere hour
bpm	beats per minute
°C	centigrade
cc	cubic centimeter
cm	centimeter
dB	decibel
DS	dyne, second
°F	fahrenheit
g	gram
hr	hour
hPa	hundred pascal
Hz	hertz
in	inch
k	kilo
kg	kilogram
kPa	kilopascal
l	litre
lb	pound
m	meter
mg	milligrams
min	minute
ml	milliliter
mm	millimeters
ms	millisecond
mV	millivolt
mW	milliwatt
nm	nanometer
ppm	part per million
s	second
V	volt
VA	volt ampere
Ω	ohm
μA	microampere
μm	micron

μV	microvolt
W	watt

D.2 Symbols

-	minus
%	percent
/	per; divide; or
^	power
+	plus
=	equal to
<	less than
>	greater than
≤	less than or equal to
≥	greater than or equal to
±	plus or minus
×	multiply
©	copyright

D.3 Abbreviations

AAMI	Association for Advancement of Medical Instrumentation
AC	alternating current
AHA	American Heart Association
ANSI	American National Standard Institute
ARR	arrhythmia
ART	arterial
AUX	Auxiliary output
aVF	left foot augmented lead
aVL	left arm augmented lead
aVR	right arm augmented lead
CH	channel
CISPR	International Special Committee on Radio Interference
CMS	central monitoring system
EKG	electrocardiograph

EMC	electromagnetic compatibility
err	error
ES	electrosurgical
ESU	electrosurgical unit
HR	heart rate
HT	height
IEC	International Electrotechnical Commission
ISO	International organization for standardization
MRI	magnetic resonance imaging
LA(L)	left arm
LAP	left atria pressure
LED	light emitting diode
LL(F)	left leg
Loop	loop read-write test fail
M, MEAN	mean pressure
O ₂	oxygen
P	power
PR	pulse rate
QRS	interval of ventricular depolarization (QRS complex)
RA(R)	right arm
RL(N)	right leg
ROM	read-only memory
SpO ₂	arterial oxygen saturation from pulse oximetry
VGA	Video Graphics Array

