

Passport 12m/Passport 17m

Patient Monitor

Operator's Manual

© Copyright 2013 - 2019 Shenzhen Mindray Bio-Medical Electronics Co., Ltd. All rights reserved.

- Release time: 2019-08
- Revision: 17.0

WARNING

- **Federal Law (USA) restricts this device to sale by or on the order of a physician or other practitioner licensed by U.S. state law to use or order the use of this device.**
-

Intellectual Property Statement

SHENZHEN MINDRAY BIO-MEDICAL ELECTRONICS CO., LTD. (hereinafter called Mindray) owns the intellectual property rights to this Mindray product and this manual. This manual may refer to information protected by copyrights or patents and does not convey any license under the patent rights or copyright of Mindray, or of others.

Mindray intends to maintain the contents of this manual as confidential information. Disclosure of the information in this manual in any manner whatsoever without the written permission of Mindray is strictly forbidden.

Release, amendment, reproduction, distribution, rental, adaption and translation or any other derivative work of this manual in any manner whatsoever without the written permission of Mindray is strictly forbidden.

mindray ,  **MINDRAY** are the trademarks, registered or otherwise, of Mindray in China and other countries. All other trademarks that appear in this manual are used only for information or editorial purposes. They are the property of their respective owners.

This posting serves as notice under 35 U.S.C. § 287(a) for Mindray patents: <http://www.mindrayna.com/patents>.

Manufacturer's Responsibility

Contents of this manual are subject to changes without prior notice.

All information contained in this manual is believed to be correct. Mindray is not liable for errors contained herein nor for incidental or consequential damages in connection with the furnishing, performance, or use of this manual.

Mindray is responsible for the effects on safety, reliability and performance of this product, only if:

- all installation operations, expansions, changes, modifications and repairs of this product are conducted by Mindray authorized personnel;
- the electrical installation of the relevant room complies with the applicable national and local requirements;
- the product is used in accordance with the instructions for use.

WARNING

- **Only skilled/trained clinical professionals should operate this equipment.**
 - **It is important for the hospital or organization that uses this equipment to perform a recommended service/maintenance plan. Neglect of this may result in machine breakdown or personal injury.**
-
-

Service

Mindray maintains a network of service representatives and factory-trained distributors. Prior to requesting service, perform a complete operational check of the instrument to verify proper control settings. If operational problems continue to exist, contact Mindray Service.

In North America contact the Service Department at (800) 288-2121, ext: 8116 for Technical Support or (201) 995-8000 for assistance in determining the nearest field service location.

Please include the instrument model number, the serial number, and a description of the problem with all requests for service.

Any questions regarding the warranty should be directed to your local sales or service representative.

Company Contact

Manufacturer:	Shenzhen Mindray Bio-Medical Electronics Co., Ltd.
Address:	Mindray Building, Keji 12th Road South, High-tech industrial park, Nanshan, Shenzhen 518057, P.R. China
Website:	www.mindray.com
E-mail Address:	service@mindray.com
Tel:	+86 755 81888998
Fax:	+86 755 26582680
Distributor:	Mindray DS USA, Inc.
Address:	800 MacArthur Boulevard, Mahwah, New Jersey, 07430 USA
Tel:	1.800.288.2121, 1.201.995.8000
Website:	www.mindray.com

Preface

Manual Purpose

This manual contains the instructions necessary to operate the product safely and in accordance with its function and intended use. Observance of this manual is a prerequisite for proper product performance and correct operation and ensures patient and operator safety.

This manual is based on the maximum configuration and therefore some contents may not apply to your product. If you have any question, please contact Mindray.

This manual is an integral part of the product. It should always be kept close to the equipment so that it can be conveniently referenced when needed.

Intended Audience

This manual is intended for clinical professionals who are expected to have a working knowledge of medical procedures, practices and terminology as required for monitoring of patients.

Illustrations

All illustrations in this manual serve as examples only. They may not necessarily reflect the setup or data displayed on your monitor.

Conventions

- ***Italic text*** is used to quote the referenced chapters or sections.
- [] is used to enclose screen texts.
- → is used to indicate operational procedures.

Contents

- 1 Safety.....1-1**
 - 1.1 Safety Information..... 1-1
 - 1.1.1 Warnings 1-1
 - 1.1.2 Cautions 1-2
 - 1.1.3 Notes..... 1-3
 - 1.2 Equipment Symbols..... 1-3

- 2 The Basics2-1**
 - 2.1 Monitor Description..... 2-1
 - 2.1.1 Intended Use 2-1
 - 2.1.2 Applied Parts 2-2
 - 2.2 Main Unit..... 2-2
 - 2.2.1 Front View..... 2-2
 - 2.2.2 Side View 2-4
 - 2.2.3 Rear View 2-5
 - 2.2.4 Bottom View (Passport 17m) 2-7
 - 2.3 Satellite Module Rack 2-8
 - 2.4 Modules 2-10
 - 2.4.1 Multi-Parameter Module..... 2-11
 - 2.4.2 T1 2-13
 - 2.4.3 N1 2-14
 - 2.5 Display Screen 2-15
 - 2.6 QuickKeys..... 2-17

- 3 Basic Operations3-1**
 - 3.1 Installation 3-1
 - 3.1.1 Unpacking and Checking 3-1
 - 3.1.2 Environmental Requirements 3-2
 - 3.2 Getting Started..... 3-2
 - 3.2.1 Connecting to Power Source..... 3-2
 - 3.2.2 Turning Power On 3-3
 - 3.2.3 Starting Monitoring..... 3-4
 - 3.3 Turning Off the Monitor..... 3-4
 - 3.4 Using the Knob..... 3-5
 - 3.5 Using a Mouse 3-5
 - 3.6 Using Keys..... 3-5
 - 3.7 Using the On-screen Keyboard 3-6
 - 3.8 Using the Touchscreen..... 3-6
 - 3.9 Using the [Main Menu] 3-6
 - 3.10 Setting the Screen..... 3-7
 - 3.11 Displaying the Timer..... 3-8
 - 3.12 Changing General Settings 3-9
 - 3.12.1 Setting up a Monitor..... 3-9

3.12.2 Changing Language	3-9
3.12.3 Adjusting the Screen Brightness.....	3-10
3.12.4 Showing/Hiding the Help Text	3-10
3.12.5 Setting the Date and Time	3-10
3.12.6 Adjusting Volume	3-10
3.13 Setting Parameters	3-11
3.13.1 Switching the Parameters On/Off.....	3-11
3.13.2 Accessing the Parameters Menu	3-12
3.13.3 Removing a Module Conflict.....	3-12
3.14 Using a CF Storage Card.....	3-13
3.15 Operating Modes	3-14
3.15.1 Monitoring Mode.....	3-14
3.15.2 Night Mode.....	3-14
3.15.3 Privacy Mode.....	3-15
3.15.4 Standby Mode	3-15
4 Managing Patients.....	4-1
4.1 Admitting a Patient	4-1
4.2 Quick Admitting a Patient.....	4-2
4.3 Setting the Monitor Location.....	4-2
4.4 Querying and Obtaining Patient Information	4-2
4.5 Querying from Local Facility	4-3
4.6 Associating Patient Information.....	4-3
4.7 Editing Patient Information	4-3
4.8 Discharging a Patient	4-4
4.9 Transferring Patient Data.....	4-4
4.9.1 Transferring Patient Data via MPM/T1/N1	4-5
4.9.2 Transferring Patient Data via a CF Storage Card or USB Drive.....	4-6
4.10 Connecting to a CMS.....	4-7
5 Managing Configurations	5-1
5.1 Introduction	5-1
5.2 Accessing the [Manage Configuration] Menu	5-2
5.3 Changing Department.....	5-2
5.4 Setting Default Configuration	5-3
5.5 Saving Current Settings.....	5-3
5.6 Editing Configurations.....	5-4
5.7 Deleting a Configuration.....	5-5
5.8 Transferring a Configuration	5-5
5.9 Loading a Configuration.....	5-5
5.10 Restoring the Latest Configuration Automatically.....	5-6
6 User Screens.....	6-1
6.1 Configuring Your Screens.....	6-1
6.1.1 Changing the Waveform Line Size	6-1
6.1.2 Changing Measurement Colors.....	6-1

6.1.3 Changing Screen Layout.....	6-1
6.1.4 Setting the Waveform Sweep Mode.....	6-2
6.2 Viewing Minitrends.....	6-2
6.2.1 Having a Split-Screen View of Minitrends.....	6-2
6.2.2 Setting Minitrends.....	6-3
6.3 Viewing OxyCRG.....	6-3
6.4 Viewing Other Patients.....	6-4
6.4.1 Care Group.....	6-4
6.4.2 Viewing the Care Group Overview Bar.....	6-5
6.4.3 Understanding the View Other Patient Window.....	6-6
6.5 Understanding the Big Numerics Screen.....	6-7
7 Alarms.....	7-1
7.1 Alarm Categories.....	7-1
7.2 Alarm Levels.....	7-2
7.3 Alarm Indicators.....	7-2
7.3.1 Alarm Lamp.....	7-2
7.3.2 Alarm Messages.....	7-2
7.3.3 Flashing Numeric.....	7-3
7.3.4 Audible Alarm Tones.....	7-3
7.3.5 Alarm Status Symbols.....	7-4
7.4 Alarm Tone Configuration.....	7-4
7.4.1 Setting the Minimum Alarm Volume.....	7-4
7.4.2 Changing the Alarm Volume.....	7-4
7.4.3 Setting the Interval Between Alarm Sounds.....	7-5
7.4.4 Changing the Alarm Tone Pattern.....	7-5
7.4.5 Setting the Reminder Tones.....	7-6
7.5 Understanding the Alarm Setup Menu.....	7-6
7.5.1 Setting Alarm Properties for All Parameters.....	7-7
7.5.2 Adjusting Alarm Limits Automatically.....	7-7
7.5.3 Setting Alarm Delay Time.....	7-10
7.5.4 Setting SpO2 Technical Alarm Delay.....	7-11
7.5.5 Setting Recording Length.....	7-11
7.5.6 Entering CPB Mode (Cardiopulmonary Bypass Mode).....	7-11
7.6 Pausing Alarms.....	7-12
7.7 Switching Off All Alarms.....	7-12
7.8 Resetting Alarms.....	7-13
7.9 Latching Alarms.....	7-14
7.10 Testing Alarms.....	7-15
7.11 Using Care Group Alarms.....	7-15
7.11.1 Care Group Auto Alarms.....	7-15
7.11.2 Setting Care Group Alert Tone.....	7-15
7.11.3 Resetting Care Group Alarms.....	7-16
8 Monitoring ECG.....	8-1
8.1 Introduction.....	8-1

8.2 Safety.....	8-1
8.3 Preparing to Monitor ECG.....	8-2
8.3.1 Preparing the Patient and Placing the Electrodes	8-2
8.3.2 Choosing AHA or IEC Lead Placement	8-2
8.3.3 ECG Lead Placements	8-3
8.3.4 Checking Paced Status	8-4
8.4 Understanding the ECG Display.....	8-5
8.5 Changing ECG Settings.....	8-6
8.5.1 Accessing ECG Menus	8-6
8.5.2 Choosing the Alarm Source	8-6
8.5.3 Changing ECG Wave Settings	8-6
8.5.4 Changing the ECG Filter Settings	8-7
8.5.5 Setting the ECG Lead Set	8-7
8.5.6 Choosing an ECG Display Screen	8-7
8.5.7 Setting the Notch Filter.....	8-8
8.5.8 Changing the Pacer Reject Settings	8-8
8.5.9 Enabling Smart Lead Off.....	8-8
8.5.10 Setting the Alarm Level for ECG Lead Off Alarms.....	8-8
8.5.11 Adjusting QRS Volume.....	8-9
8.5.12 About the Defibrillator Synchronization	8-9
8.5.13 Adjusting the Minimum QRS Detection Threshold (For Advanced ECG Algorithm Only)	8-9
8.6 About ST Monitoring	8-10
8.6.1 Switching ST Monitoring On and Off.....	8-10
8.6.2 Understanding the ST Display.....	8-11
8.6.3 Saving the Current ST Segment as Reference	8-12
8.6.4 Changing the Reference Segment.....	8-12
8.6.5 Deleting a Reference Segment	8-12
8.6.6 Recording the ST Segment.....	8-12
8.6.7 Changing the ST Alarm Limits.....	8-13
8.6.8 Setting the ST Alarm Delay Time	8-13
8.6.9 Adjusting ST Measurement Points	8-13
8.7 QT/QTc Interval Monitoring (For Advanced ECG Algorithm Only).....	8-14
8.7.1 QT/QTc Monitoring Limitations	8-15
8.7.2 Enabling QT/QTc Monitoring.....	8-15
8.7.3 Displaying QT/QTc Parameters and Waveform	8-16
8.7.4 Accessing the QT View	8-16
8.7.5 Changing QT Settings.....	8-17
8.8 About Arrhythmia Monitoring	8-18
8.8.1 Understanding the Arrhythmia Events.....	8-19
8.8.2 Changing Arrhythmia Alarm Settings.....	8-20
8.8.3 Changing Arrhythmia Threshold Settings.....	8-20
8.8.4 Setting the Extended Arrhythmia (For Advanced ECG Algorithm Only)	8-21
8.8.5 Reviewing Arrhythmia Events	8-21
8.9 ECG Relearning.....	8-21
8.9.1 Initiating an ECG Relearning Manually.....	8-21
8.9.2 Automatic ECG Relearning.....	8-22

8.10 12-lead ECG Monitoring.....	8-22
8.10.1 Setting ECG Waveform Sequence.....	8-23
8.10.2 Extending the Rhythm Lead Waveform area.....	8-23
8.11 Resting 12-Lead ECG Analysis.....	8-23
8.11.1 Accessing the 12-Lead Screen.....	8-23
8.11.2 Entering Patient Information.....	8-24
8.11.3 12-Lead Setup.....	8-25
8.11.4 Setting the 12-lead Order.....	8-26
8.11.5 Resting 12-lead ECG Analysis.....	8-26
8.11.6 12-lead ECG Report.....	8-28
8.12 Troubleshooting.....	8-29
9 Monitoring Respiration (Resp)	9-1
9.1 Introduction.....	9-1
9.2 Safety Information.....	9-1
9.3 Understanding the Resp Display.....	9-1
9.4 Placing Resp Electrodes.....	9-2
9.4.1 Optimizing Lead Placement for Resp.....	9-3
9.4.2 Cardiac Overlay.....	9-3
9.4.3 Abdominal Breathing.....	9-3
9.4.4 Lateral Chest Expansion.....	9-3
9.5 Choosing the Respiration Lead.....	9-3
9.6 Changing the Apnea Alarm Delay.....	9-3
9.7 Changing Resp Detection Mode.....	9-4
9.8 Changing Resp Wave Settings.....	9-4
9.9 Setting Respiration Rate (RR) Source.....	9-5
9.10 Setting Alarm Properties.....	9-5
10 Monitoring PR.....	10-1
10.1 Introduction.....	10-1
10.2 Setting the PR Source.....	10-1
10.3 Selecting the Active Alarm Source.....	10-2
10.4 QRS Tone.....	10-2
11 Monitoring SpO₂	11-1
11.1 Introduction.....	11-1
11.2 Safety.....	11-2
11.3 Identifying SpO ₂ Modules.....	11-2
11.4 Applying the Sensor.....	11-2
11.5 Changing SpO ₂ Settings.....	11-3
11.5.1 Accessing SpO ₂ Menus.....	11-3
11.5.2 Adjusting the Desat Alarm.....	11-3
11.5.3 Setting SpO ₂ Sensitivity.....	11-3
11.5.4 Changing Averaging Time.....	11-3
11.5.5 Monitoring SpO ₂ and NIBP Simultaneously.....	11-4
11.5.6 Sat-Seconds Alarm Management.....	11-4
11.5.7 Changing the Speed of the Pleth/Plethb Wave.....	11-5

11.5.8 Zooming PI Value	11-5
11.5.9 Setting the Alarm Level for SpO2 Sensor Off Alarm	11-5
11.5.10 Setting the SpO2 Tone Mode	11-6
11.6 Measurement Limitations.....	11-6
11.7 Masimo Information	11-7
11.8 Nellcor Information.....	11-7
11.9 Troubleshooting.....	11-8
12 Monitoring NIBP	12-1
12.1 Introduction.....	12-1
12.2 Safety	12-2
12.3 Measurement Limitations.....	12-2
12.4 Measurement Methods.....	12-3
12.5 Setting Up the NIBP Measurement.....	12-3
12.5.1 Preparing the Patient.....	12-3
12.5.2 Preparing to Measure NIBP.....	12-3
12.5.3 Starting and Stopping Measurements.....	12-4
12.5.4 Correcting the Measurement if Limb is not at Heart Level.....	12-4
12.5.5 Enabling NIBP Auto Cycling and Setting the Interval	12-4
12.5.6 Enabling Measurement on Clock.....	12-4
12.5.7 Starting a STAT Measurement.....	12-5
12.6 Understanding the NIBP Numerics.....	12-5
12.7 Changing NIBP Settings	12-6
12.7.1 Setting the Initial Cuff Inflation Pressure.....	12-6
12.7.2 Setting NIBP Alarm Properties	12-6
12.7.3 Displaying NIBP List	12-6
12.7.4 Setting the Pressure Unit.....	12-6
12.7.5 Switching On NIBP End Tone.....	12-6
12.8 Assisting Venous Puncture	12-7
13 Monitoring Temp	13-1
13.1 Introduction.....	13-1
13.2 Safety	13-1
13.3 Taking a Temp Measurement.....	13-1
13.4 Understanding the Temp Display.....	13-1
13.5 Setting the Temperature Unit.....	13-2
14 Monitoring IBP	14-1
14.1 Introduction.....	14-1
14.2 Safety	14-1
14.3 Zeroing the Transducer	14-2
14.4 Setting Up the Pressure Measurement.....	14-3
14.5 Understanding the IBP Display	14-4
14.6 Changing IBP Settings	14-4
14.6.1 Changing a Pressure for Monitoring.....	14-4
14.6.2 Setting Alarm Properties	14-5

14.6.3 Changing Averaging Time.....	14-5
14.6.4 Setting Up the IBP Wave	14-5
14.6.5 Setting the Pressure Unit.....	14-5
14.6.6 Enabling PPV Measurement and Setting PPV Source	14-6
14.7 Overlapping IBP Waveforms	14-6
14.8 Measuring PAWP.....	14-7
14.8.1 Preparing to Measure PAWP	14-7
14.8.2 Setting Up the PAWP Measurement	14-8
14.8.3 Understanding the PAWP Setup Menu	14-9
14.9 Troubleshooting	14-10
15 Monitoring Cardiac Output	15-1
15.1 Introduction.....	15-1
15.2 Understanding the C.O. Display.....	15-2
15.3 Influencing Factors	15-2
15.4 Setting Up the C.O. Measurement	15-3
15.5 Measuring the Blood Temperature	15-6
15.6 Changing C.O. Settings.....	15-6
15.6.1 Setting the Temperature Unit	15-6
15.6.2 Setting Alarm Properties	15-6
16 Monitoring CCO/SvO₂	16-1
16.1 Introduction.....	16-1
16.2 Safety	16-1
16.3 Automatic Communication Detection	16-2
16.4 Connecting the Device.....	16-2
16.4.1 Connecting the Vigilance II® Monitor	16-2
16.4.2 Connecting the Vigileo™ Monitor	16-4
16.4.3 Connecting the EV1000 Monitor	16-5
16.5 Understanding CCO Parameters.....	16-6
16.5.1 Hemodynamic Parameters for Vigilance II® Monitor	16-6
16.5.2 Hemodynamic Parameters for Vigileo™ Monitor	16-7
16.5.3 Hemodynamic Parameters for EV1000 Monitor.....	16-7
16.6 Understanding the CCO Display.....	16-8
16.7 Changing CCO Settings.....	16-9
16.7.1 Selecting Vascular Resistance Unit.....	16-9
16.7.2 Selecting the Displayed Parameters	16-9
16.7.3 Checking the C.O. Measurements	16-9
16.7.4 Setting Signal Output.....	16-10
16.7.5 Selecting Alarm Properties	16-10
16.8 Understanding SvO ₂ /ScvO ₂ Parameters.....	16-11
16.8.1 Oxygenation Parameters for Vigilance II® Monitor	16-11
16.8.2 Oxygenation Parameters for Vigileo™ Monitor.....	16-11
16.8.3 Oxygenation Parameters for EV1000 Monitor	16-12
16.9 Understanding the SvO ₂ /ScvO ₂ Display.....	16-12
16.10 Changing SvO ₂ /ScvO ₂ Settings.....	16-13

16.10.1 Setting Signal Output	16-13
16.10.2 Selecting Alarm Properties	16-13
17 Monitoring ScvO₂.....	17-1
17.1 Introduction	17-1
17.2 Safety Information	17-1
17.3 Performing ScvO ₂ Measurements	17-2
17.4 ScvO ₂ Calibration.....	17-3
17.5 Understanding the ScvO ₂ Display.....	17-3
17.6 Understanding ScvO ₂ Parameters.....	17-4
17.7 Changing ScvO ₂ Settings	17-4
17.7.1 Selecting Hb/Hct.....	17-4
17.7.2 Selecting Alarm Properties	17-4
18 Monitoring CO₂	18-1
18.1 Introduction.....	18-1
18.2 Identifying CO ₂ Modules.....	18-2
18.3 Preparing to Measure CO ₂	18-2
18.3.1 Making a Sidestream CO ₂ Measurement.....	18-3
18.3.2 Making a Microstream CO ₂ Measurement.....	18-4
18.4 Changing CO ₂ Settings	18-4
18.4.1 Accessing CO ₂ Menus	18-4
18.4.2 Setting the CO ₂ Unit.....	18-4
18.4.3 Setting Up Gas Compensations	18-5
18.4.4 Setting Up Humidity Compensation	18-5
18.4.5 Setting the Apnea Alarm Delay	18-6
18.4.6 Choosing a Time Interval for Peak-Picking.....	18-6
18.4.7 Setting the Flow Rate	18-6
18.4.8 Setting up the CO ₂ Wave	18-7
18.4.9 Setting RR Source	18-7
18.4.10 Barometric Pressure Compensation.....	18-7
18.4.11 Entering the Standby Mode.....	18-7
18.5 Measurement Limitations.....	18-8
18.6 Leakage test.....	18-8
18.7 Troubleshooting the Sidestream CO ₂ Sampling System.....	18-9
18.8 Removing Exhaust Gases from the System.....	18-9
18.9 Zeroing the Sensor	18-9
18.10 Calibrating the Sensor	18-10
18.11 Oridion Information	18-10
19 Monitoring AG.....	19-1
19.1 Introduction.....	19-1
19.2 Identifying AG Modules.....	19-1
19.3 Understanding the AG Display.....	19-2
19.4 MAC Values.....	19-3
19.5 Preparing to Measure AG.....	19-4

19.6 Changing AG Settings	19-5
19.6.1 Setting Gas Unit	19-5
19.6.2 Setting the Apnea Alarm Delay	19-5
19.6.3 Changing the Sample Flow Rate.....	19-6
19.6.4 Entering the Standby Mode	19-6
19.6.5 Setting Up the AG Wave.....	19-7
19.6.6 Setting RR Source	19-7
19.7 Changing the Anesthetic Agent.....	19-7
19.8 Measurement Limitations.....	19-7
19.9 Troubleshooting	19-8
19.9.1 When the Gas Inlet is Blocked.....	19-8
19.9.2 When an Internal Occlusion Occurs.....	19-8
19.10 Removing Exhaust Gases from the System.....	19-8
20 Monitoring Bispectral Index (BIS)	20-1
20.1 Introduction	20-1
20.2 Safety Information	20-2
20.3 Understanding the BIS Display	20-3
20.3.1 BIS Parameter Area	20-3
20.3.2 BIS Waveform Area.....	20-5
20.3.3 BIS Expand View	20-6
20.4 Setting up the BIS Measurement.....	20-8
20.5 Auto Impedance Check	20-9
20.6 Sensor Check	20-9
20.7 BIS Sensor Check Window	20-10
20.8 Choosing the BIS Smoothing Rate.....	20-11
20.9 Changing the Secondary Parameters	20-11
20.10 Changing the EEG Wave Size.....	20-11
20.11 Changing the Speed of the EEG Wave	20-11
20.12 Setting the Trend Length.....	20-12
20.13 Switching the Filter On or Off.....	20-12
20.14 Covidien Information.....	20-12
21 Monitoring NMT (From TOF-Watch® SX Monitor)	21-1
21.1 Introduction	21-1
21.2 Safety	21-1
21.3 Connecting a TOF-Watch® SX monitor	21-1
21.4 NMT Parameters.....	21-1
21.5 Accessing the NMT Setup menu	21-2
21.6 NMT Display	21-2
22 Monitoring Respiratory Mechanics (RM)	22-1
22.1 Introduction	22-1
22.2 Safety Information	22-2
22.3 Preparing to Monitor RM	22-3
22.4 Understanding the RM Display.....	22-4

22.5 Changing RM Settings	22-4
22.5.1 Accessing RM Menus	22-4
22.5.2 Setting the Apnea Alarm Delay	22-5
22.5.3 Selecting TV or MV for Display.....	22-5
22.5.4 Selecting Flow or Vol Waveform for Display	22-5
22.5.5 Changing the Wave Sweep Speed.....	22-5
22.5.6 Changing the Wave Scale.....	22-6
22.5.7 Setting RR Source	22-6
22.6 Understanding the Respiratory Loops.....	22-6
22.7 Zeroing the RM Module	22-7
22.8 Calibrating the Flow Sensor	22-7
23 Monitoring NMT (from Mindray NMT Module).....	23-1
23.1 Introduction.....	23-1
23.2 Safety	23-1
23.3 Stimulation Modes.....	23-2
23.3.1 Train-Of-Four (TOF)	23-2
23.3.2 Single Twitch (ST).....	23-3
23.3.3 Post-Tetanic Count (PTC)	23-3
23.3.4 Double-Burst Stimulation (DBS).....	23-3
23.4 Preparing for NMT Measurement.....	23-4
23.4.1 Skin Preparation	23-4
23.4.2 Placing the Electrodes and Sensor	23-4
23.5 Accessing the NMT Setup Menu	23-5
23.6 Calibrating the NMT Measurement	23-6
23.6.1 Starting/Stopping NMT Measurements.....	23-6
23.7 Change NMT Measurement Settings	23-7
23.7.1 Changing Stimulation Mode.....	23-7
23.7.2 Changing Stimulation Current	23-7
23.7.3 Changing Pulse Width.....	23-7
23.7.4 Changing Measurement Interval.....	23-7
23.8 Enabling Block Recovery Note	23-7
23.9 Adjusting Stimulation Tone Volume	23-7
23.10 Understanding NMT Display	23-8
23.11 Recalling Calibration Information.....	23-9
24 Device Integration	24-1
24.1 Introduction.....	24-1
24.2 Safety Information	24-1
24.3 Supported Devices and Device Connection Method	24-2
24.4 Differences in Displayed Values	24-2
24.5 Devices Integrated Window.....	24-3
24.6 System Functions of the Monitor	24-4
24.6.1 Alarms.....	24-4
24.6.2 Data Storage.....	24-4
24.6.3 Recording and Printing.....	24-4

25 Monitoring tcGas	25-1
25.1 Introduction	25-1
25.2 Safety Information	25-1
25.3 Connecting an External Device.....	25-2
25.4 tcGas Parameters.....	25-2
25.5 Displaying tcGas Parameters	25-3
25.6 Entering the tcGas Setup menu.....	25-3
25.7 Setting tcpCO ₂ /tcpO ₂ Unit.....	25-3
25.8 tcGas Display	25-3
26 Freezing Waveforms	26-1
26.1 Freezing Waveforms	26-1
26.2 Viewing Frozen Waveforms	26-1
26.3 Unfreezing Waveforms	26-2
26.4 Recording Frozen Waveforms.....	26-2
27 Review	27-1
27.1 Accessing Respective Review Windows	27-1
27.2 Reviewing Graphic Trends.....	27-1
27.3 Reviewing Tabular Trends	27-2
27.4 Reviewing Events	27-3
27.4.1 Marking Events.....	27-3
27.4.2 Reviewing Events.....	27-4
27.5 Reviewing Waveforms.....	27-6
27.6 Reviewing OxyCRG	27-7
28 Calculations.....	28-1
28.1 Introduction.....	28-1
28.2 Dose Calculations.....	28-2
28.2.1 Performing Calculations	28-2
28.2.2 Selecting the Proper Drug Unit	28-2
28.2.3 Titration Table	28-3
28.2.4 Drug Calculation Formulas	28-3
28.3 Oxygenation Calculations	28-3
28.3.1 Performing Calculations	28-3
28.3.2 Entered Parameters.....	28-4
28.3.3 Calculated Parameters and Formulas.....	28-4
28.4 Ventilation Calculations.....	28-5
28.4.1 Performing Calculations	28-5
28.4.2 Entered Parameters.....	28-5
28.4.3 Calculated Parameters and Formulas.....	28-5
28.5 Hemodynamic Calculations	28-6
28.5.1 Performing Calculations	28-6
28.5.2 Entered Parameters.....	28-6
28.5.3 Calculated Parameters and Formulas.....	28-7
28.6 Renal Calculations.....	28-7

28.6.1 Performing Calculations	28-7
28.6.2 Entered Parameters.....	28-8
28.6.3 Calculated Parameters and Formulas.....	28-8
28.7 Understanding the Review Window	28-8
29 Recording	29-1
29.1 Using a Recorder.....	29-1
29.2 Overview of Recording Types.....	29-1
29.3 Starting and Stopping Recordings	29-2
29.4 Setting up the Recorder	29-2
29.4.1 Accessing the Record Setup Menu	29-2
29.4.2 Selecting Waveforms for Recording.....	29-2
29.4.3 Setting the Realtime Recording Length	29-3
29.4.4 Setting the Interval between Timed Recordings	29-3
29.4.5 Changing the Recording Speed.....	29-3
29.4.6 Clearing Recording Tasks.....	29-3
29.4.7 Setting the IBP Waveform Overlap Recordings	29-3
29.5 Loading Paper	29-3
29.6 Removing Paper Jam	29-4
29.7 Cleaning the Recorder Printhead	29-4
30 Printing	30-1
30.1 Printer	30-1
30.2 Connecting a printer.....	30-1
30.3 Setting Up the Printer	30-2
30.4 Starting Report Printouts.....	30-2
30.5 Stopping Report Printouts	30-3
30.6 Setting Up Reports	30-3
30.6.1 Setting Up ECG Reports.....	30-3
30.6.2 Setting Up Tabular Trends Reports.....	30-3
30.6.3 Setting Up Graphic Trends Reports.....	30-3
30.6.4 Setting Up Realtime Reports.....	30-4
30.7 End Case Reports.....	30-4
30.8 Printer Statuses	30-4
30.8.1 Printer Out of Paper	30-4
30.8.2 Printer Status Messages.....	30-4
31 Other Functions	31-1
31.1 Analog Output.....	31-1
31.2 Exporting the Log	31-1
31.3 Transferring Data	31-1
31.3.1 Data Export System.....	31-1
31.3.2 Transferring Data by Different Means.....	31-2
31.4 Nurse Call.....	31-2
31.5 iView System (for Passport 17m only).....	31-3
31.5.1 Start, Power off and Restart iView System	31-4

31.5.2	Configuring Application Program ShortCuts	31-4
31.5.3	Using PC Software	31-6
31.5.4	iView Window Close and Standby	31-6
31.5.5	Recover iView System.....	31-7
31.5.6	Remote Login.....	31-7
31.5.7	Using McAfee Solidifier.....	31-7
31.6	Network Setup	31-8
31.6.1	Setting the Network Type	31-8
31.6.2	Wireless Network Connection (For Passport 12m Only).....	31-8
31.6.3	Viewing the MAC Address	31-10
31.6.4	Enabling the Data Encryption.....	31-11
31.6.5	Connecting the Monitor to the CMS.....	31-11
31.6.6	Setting the Network Service Quality Level	31-12
31.6.7	Setting the Multicast Parameters.....	31-12
31.7	MLDAP	31-13
31.7.1	Setting MLDAP	31-13
31.7.2	Selecting Password for User Authentication	31-13
31.8	Using DVI-VGA Adapter Box.....	31-14
32	Batteries	32-1
32.1	Overview.....	32-1
32.2	Safety	32-2
32.3	Battery Guidelines.....	32-2
32.4	Installing or Replacing a Battery.....	32-3
32.5	Charging a Battery	32-4
32.6	Conditioning a Battery	32-4
32.7	Checking Battery Performance.....	32-5
32.8	Storing a Battery.....	32-6
32.9	Recycling a Battery	32-6
33	Care and Cleaning.....	33-1
33.1	General Points	33-1
33.2	Cleaning and Disinfecting the Main Unit/Module/SMR.....	33-2
33.2.1	Approved Cleaning and Disinfecting Agents.....	33-2
33.2.2	Cleaning the Main Unit/Module/SMR	33-3
33.2.3	Disinfecting the Main Unit/Module/SMR.....	33-3
33.3	Cleaning and Disinfecting the Accessories	33-4
33.3.1	Approved Accessories Cleaning and Disinfecting Agents.....	33-4
33.3.2	Cleaning the Accessories.....	33-7
33.3.3	Disinfecting the Accessories.....	33-7
33.4	Sterilization	33-7
34	User Maintenance	34-1
34.1	General Inspection.....	34-1
34.2	Maintenance and Testing Schedule.....	34-2
34.3	Checking Monitor and Module Information.....	34-3

34.4 ECG Verification.....	34-3
34.5 NIBP Leakage Test.....	34-4
34.6 CO ₂ Leakage Test	34-5
34.7 AG Leakage Test.....	34-5
34.8 Checking NMT Sensor.....	34-5
34.9 Calibrating the Touchscreen	34-6
35 Accessories	35-1
35.1 ECG Accessories	35-1
35.2 SpO ₂ Accessories.....	35-3
35.3 NIBP Accessories	35-4
35.4 Temp Accessories.....	35-5
35.5 IBP/ICP Accessories	35-6
35.6 C.O. Accessories.....	35-6
35.7 CO ₂ Accessories	35-7
35.8 AG Accessories.....	35-8
35.9 BIS Accessories	35-8
35.10 NMT Accessories (for Mindray NMT module)	35-8
35.11 RM Accessories.....	35-8
35.12 CCO/SvO ₂ Accessories.....	35-8
35.13 ScvO ₂ Accessories	35-9
35.14 Installation Accessories	35-9
35.15 Micellaneous Accessories	35-10
36 Part Numbers for Canadian Use	36-1
A Product Specifications.....	A-1
A.1 Monitor Safety Specifications.....	A-1
A.2 Physical Specifications.....	A-3
A.3 Hardware Specifications	A-4
A.4 Data Storage	A-6
A.5 Wireless Network (For Passport 12m Only)	A-7
A.6 Measurement Specifications	A-9
B EMC and Radio Regulatory Compliance	B-1
B.1 EMC.....	B-1
B.2 Radio Regulatory Compliance	B-5
C Default Configurations.....	C-1
C.1 Parameters Configuration.....	C-1
C.2 Routine Configuration	C-17
C.3 User Maintenance Items.....	C-22
D Alarm Messages.....	D-1
D.1 Physiological Alarm Messages	D-1
D.2 Technical Alarm Messages.....	D-3

E SpO₂ Sensor AccuracyE-1
E.1 Accuracy of Masimo SpO₂ Sensors..... E-1
E.2 Accuracy of Nellcor SpO₂ Sensors E-3

F Symbols and Abbreviations.....F-1
F.1 Symbols..... F-1
F.2 Abbreviations F-2

FOR YOUR NOTES

1 Safety

1.1 Safety Information

WARNING

- Indicates a potential hazard or unsafe practice that, if not avoided, could result in death or serious injury.
-

CAUTION

- Indicates a potential hazard or unsafe practice that, if not avoided, could result in minor personal injury or product/property damage.
-

NOTE

- Provides application tips or other useful information to ensure that you get the most from your product.
-

1.1.1 Warnings

WARNING

- Before putting the system into operation, the operator must verify that the equipment, connecting cables and accessories are in correct working order and operating condition.
 - To avoid risk of electric shock, this equipment must only be connected to a supply mains with protective earth. If a properly grounded power outlet is not available, operate the monitor on battery power.
 - The equipment is not intended to be used within the Magnetic Resonance (MR) environment.
 - To avoid an explosion hazard, do not use the equipment in the presence of oxygen-rich atmospheres, flammable anesthetics, or other flammable agents (such as gasoline).
 - Before connecting the equipment to the power line, check that the voltage and frequency ratings of the power line are the same as those indicated on the equipment's label or in this manual.
 - Do not open the equipment housings. All servicing or future upgrades must be carried out by the Mindray trained and authorized personnel.
 - Do not come into contact with patients during defibrillation. Otherwise serious injury or death could result.
 - Do not rely exclusively on the audible alarm system for patient monitoring. Adjustment of alarm volume to a low level or off may result in a hazard to the patient. Remember that alarm settings should be customized according to different patient situations and always keeping the patient under close surveillance is the most reliable way for safe patient monitoring.
-
-

WARNING

- **PATIENTS WITH A PACEMAKER** – On ventricular paced patients, episodes of Ventricular Tachycardia may not always be detected. Do not rely entirely upon the system’s automated arrhythmia detection algorithm. Keep pacemaker patients under close surveillance.
 - The physiological data and alarm messages displayed on the equipment should be reviewed by a clinician before being used for diagnostic interpretation and treatment.
 - To avoid inadvertent disconnection, route all cables in a way to prevent a stumbling hazard. Wrap and secure excess cabling to reduce risk of entanglement by patients or personnel.
 - Do not touch the equipment’s metal parts or connectors when in contact with the patient; otherwise patient injury may result.
 - Never mix patient electrode types or brands. Dissimilar metals or other incompatibilities may cause considerable baseline drift and may increase trace recovery time after defibrillation.
 - To reduce the hazard of burns during high-frequency surgical procedure, ensure that the monitor’s cables and transducers never come into contact with the electro-surgery unit (ESU).
 - The neutral electrode of the electro-surgery unit (ESU) shall properly contact the patient. Otherwise, burns may result.
 - Magnetic and electrical fields are capable of interfering with the proper performance of the equipment. For this reason make sure that all external devices operated in the vicinity of the equipment comply with the relevant EMC requirements. Mobile phone and X-ray equipment are a possible source of interference as they may emit higher levels of electromagnetic radiation.
-

1.1.2 Cautions

CAUTIONS

- Only use parts and accessories specified in this manual.
 - Disposable accessories are not designed to be reused. Reuse may cause a risk of contamination and affect the measurement accuracy.
 - Always install or carry the equipment properly to avoid damage caused by drop, impact, strong vibration or other mechanical force.
 - Dry the equipment immediately in case of rain or water spray.
 - When no battery is installed, ensure that the monitor is supplied with continuous electric power during operation. Sudden power failure may lead to data loss.
 - This equipment is intended for single patient use.
 - Store and use the equipment in specified environmental condition. The monitor and accessories may not meet the performance specification due to aging, stored or used outside the specified temperature and humidity range.
 - Disposable accessories are not designed to be reused. Reuse may cause a risk of contamination and affect the measurement accuracy.
 - Contact the Mindray service personnel for replacements if you find the housing is broken.
-















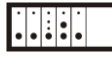

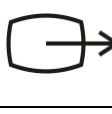
1.1.3 Notes







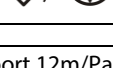



NOTES

- Put the equipment in a location where you can easily view and operate the equipment.
- During normal use, the operator is expected to face the front of the equipment.
- The equipment uses a mains plug as a means of isolation the mains power supply. Do not position the equipment in a place difficult to operate the mains plug.
- Remove the battery before shipping the monitor or if it will not be used for an extended period of time.
- Keep this manual in the vicinity of the equipment so that it can be conveniently referenced when needed.
- The software was developed in compliance with IEC60601-1. The possibility of hazards arising from software errors is minimized.
- This manual describes all features and options. Your equipment may not have all of them. They are not available in all geographies.
- Remove the battery before transporting the equipment or if the equipment will not be used for a long time.
- At the end of its service life, the equipment, as well as its accessories, must be disposed of in compliance with the guidelines regulating the disposal of such products. If you have any questions concerning disposal of the equipment, please contact Mindray.
- When disposing of the packaging material, be sure to observe the applicable waste control regulations and keep it out of children’s reach.

1.2 Equipment Symbols

Some symbols may not appear on your equipment.

	Refer to instruction manual/ booklet		
	Power ON/OFF (for a part of the equipment)		Battery indicator
	Alternating current		Connector for satellite module rack
	Equipotentiality		Video output
	USB connector		Network connector
	iView network connector		Output
	Defibrillator		Zero key
	Check sensor		Calibrate key
	Measure/standby		Inserted direction

	Gas outlet		Serial number
	DATE OF MANUFACTURE		General warning sign
	Electrostatic sensitive devices		Plastics identification symbol
	DEFIBRILLATION-PROOF TYPE CF APPLIED PART		DEFIBRILLATION-PROOF TYPE BF APPLIED PART
	Pushing prohibited (wheels locked, no pushing)	IPX1	Protected against vertically falling water drops per IEC 60529
<p>ETL CLASSIFIED</p>  <p>Intertek 3179617</p>	<p>The presence of this label indicates the machine was certified by ETL with the statement: Conforms to AAMI Std. ES 60601-1, IEC Std. 60601-1-6, IEC Std. 60601-1-8, IEC Std. 60601-2-25, IEC Std. 60601-2-26, IEC Std. 60601-2-27, IEC Std. 60601-2-34, IEC Std. 60601-2-49, IEC Std. 80601-2-30, ISO Std. 80601-2-55, ISO Std. 80601-2-56, ISO Std. 80601-2-61, IEC Std. 60601-2-10</p> <p>Certified to CSA Std. C22.2 NO. 60601-1, NO. 60601-6, NO. 60601-1-8, NO. 60601-2-25, NO. 60601-2-26, NO. 60601-2-27, NO. 60601-2-34, NO. 60601-2-49, NO. 80601-2-30, NO. 80601-2-55, NO. 80601-2-56, NO. 80601-2-61, NO. 60601-2-10</p>		

2 The Basics

2.1 Monitor Description

2.1.1 Intended Use

The Passport 17m and Passport 12m patient monitors are intended for monitoring, displaying, reviewing, alarming, and transferring of multiple physiological parameters including ECG (3-lead, 5-lead or 12-lead selectable, arrhythmia detection, ST segment analysis, QT analysis, and heart rate (HR)), respiration rate (Resp), temperature (Temp), pulse oxygen saturation (SpO₂), pulse rate (PR), non-invasive blood pressure (NIBP), invasive blood pressure (IBP), pulmonary artery wedge pressure (PAWP), cardiac output (C.O.), continuous cardiac output (CCO), mixed/central venous oxygen saturation (SvO₂/ScvO₂), carbon dioxide (CO₂), Oxygen (O₂), anesthetic gas (AG), impedance cardiograph (ICG), bispectral index (BIS), respiration mechanics (RM), and neuromuscular transmission monitoring (NMT). The equipment also provides an interpretation of resting 12-lead ECG.

All the parameters can be monitored on single adult, pediatric, and neonatal patients with the exception of the following:

- The arrhythmia detection, ST Segment analysis of Mortara algorithm, BIS, RM, CCO, SvO₂/ScvO₂, PAWP monitoring and NMT monitoring are intended for adult and pediatric patients only;
- ST Segment analysis of Mindray algorithm is intended for adult patients only;
- C.O. monitoring is restricted to adult patients only;
- ICG monitoring is only for use on adult patients who meet the following requirements: height: 122 to 229cm, weight: 30 to 155kg.

The monitor is to be used in healthcare facilities by clinical professionals or under their guidance. It should only be used by persons who have received adequate training in its use. It is not intended for helicopter transport, hospital ambulance, or home use.

WARNING

- **This patient monitor is intended for use only by clinical professionals or under their guidance. It must only be used by persons who have received adequate training in its use. Anyone unauthorized or untrained must not perform any operation on it.**
-

NOTE

- **Mindray algorithm is hereinafter referred as the Advanced ECG algorithm.**
-

2.1.2 Applied Parts

The applied parts of the Passport 12m/17m patient monitors are:

- ECG electrodes and leadwires
- SpO₂ sensor
- NIBP cuff
- Temp probes
- IBP transducer
- C.O. sensor
- CO₂ sampling line/nasal sampling cannula, and water trap
- AG sampling line, water trap, and airway adapter
- BIS sensor
- RM sensor
- ScvO₂ sensor
- NMT sensor and electrode

2.2 Main Unit

2.2.1 Front View

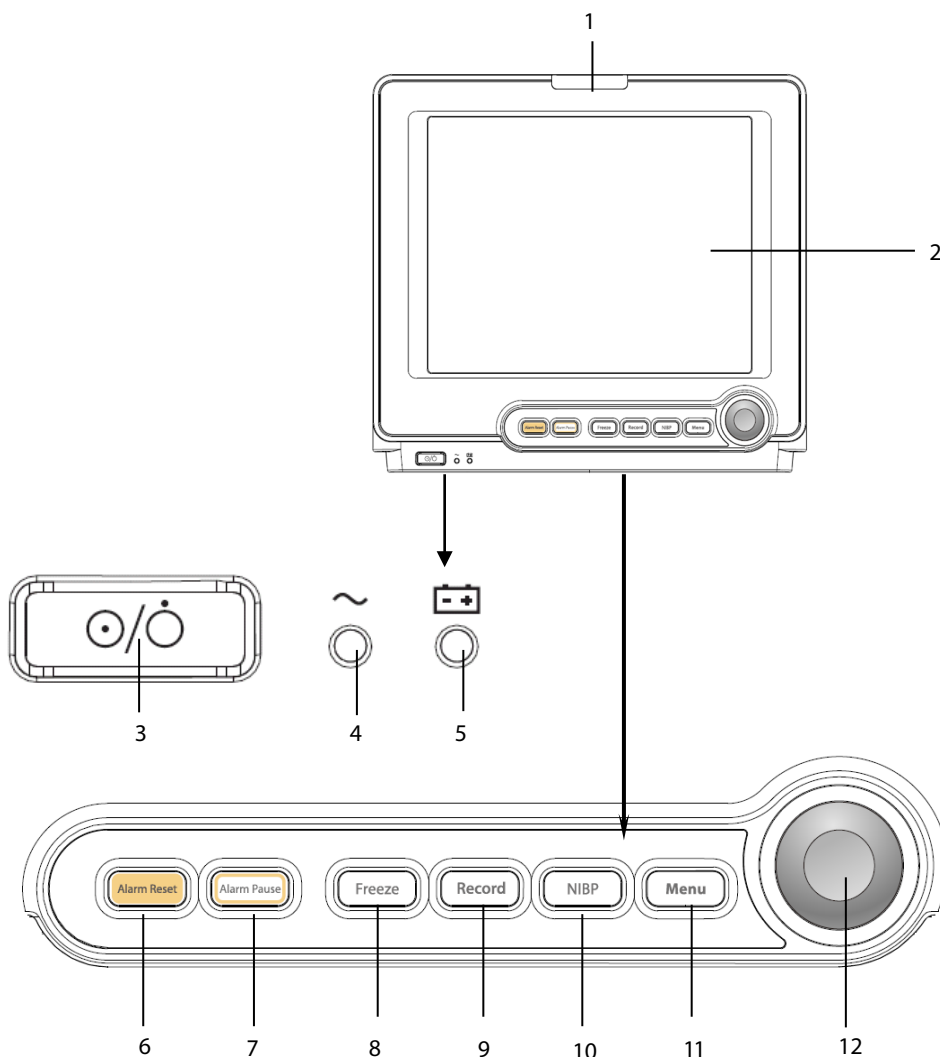

1. Alarm lamp

When a physiological alarm or technical alarm occurs, this lamp flashes as defined below.

- ◆ High level alarms: the lamp quickly flashes red.
- ◆ Medium level alarms: the lamp slowly flashes yellow.
- ◆ Low level alarms: the lamp lights yellow without flashing.

2. Display Screen

3. Power On/Off Switch

- ◆ Pressing this switch turns the monitor on.
- ◆ When the monitor is on, pressing and holding this switch turns the monitor off.

An indicator is built into this switch. It turns on when the monitor is on and turns off when the monitor is off.

4. AC power LED

It turns on when AC power is connected.

5. Battery LED

- ◆ On: when at least one battery is installed in the Passport 12m monitor and the AC source is connected; when two batteries are installed in the Passport 17m monitor and the AC source is connected.
- ◆ Off: when no battery is installed, only one battery is installed in the Passport 17m monitor, the installed battery is malfunctioning, or no AC source is connected when the monitor is powered off.
- ◆ Flashing: when the monitor operates on battery power.

6. **[Alarm Reset]** button

Press to reset the alarms.

7. **[Alarm Pause]** button

Press to pause or restore alarms.

8. **[Freeze]** button

Press to freeze or unfreeze waveforms.

9. **[Record]** button

When a recording task is not started, pressing this button starts recording. When a recording task is in progress, pressing this button stops recording.

10. **[NIBP]** button

Press to start or stop NIBP measurements.

11. **[Menu]** button

If no menu is currently displayed on the screen, pressing it enters the main menu. If a menu is displayed on the screen, pressing it closes that menu.

12. Knob

- ◆ Rotate the knob clockwise or counter-clockwise to move the cursor.
- ◆ Press the knob to select one item, such as accessing a menu or confirming the selection.

2.2.2 Side View

Passport 12m

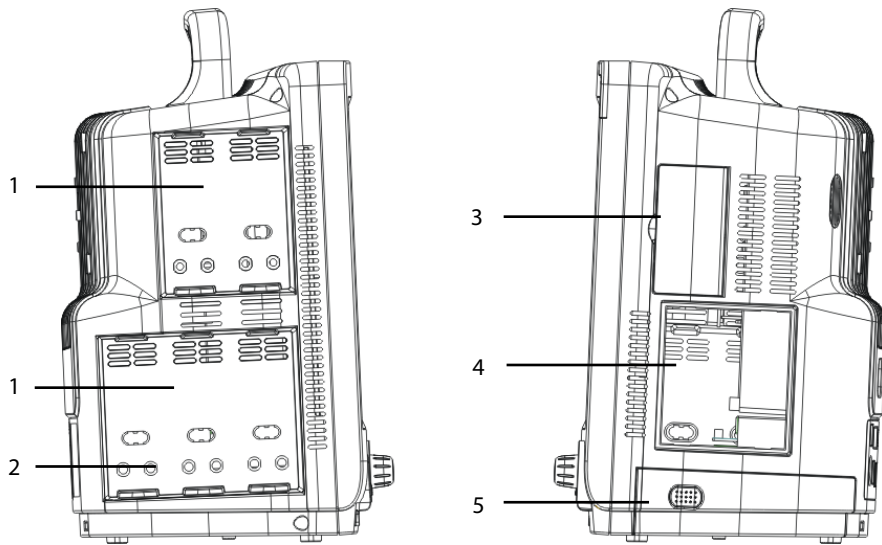

- 1. Integral Module Racks
- 2. Contact
- 3. Compartment for CF storage card slot
- 4. Recorder
- 5. Battery compartment

Passport 17m

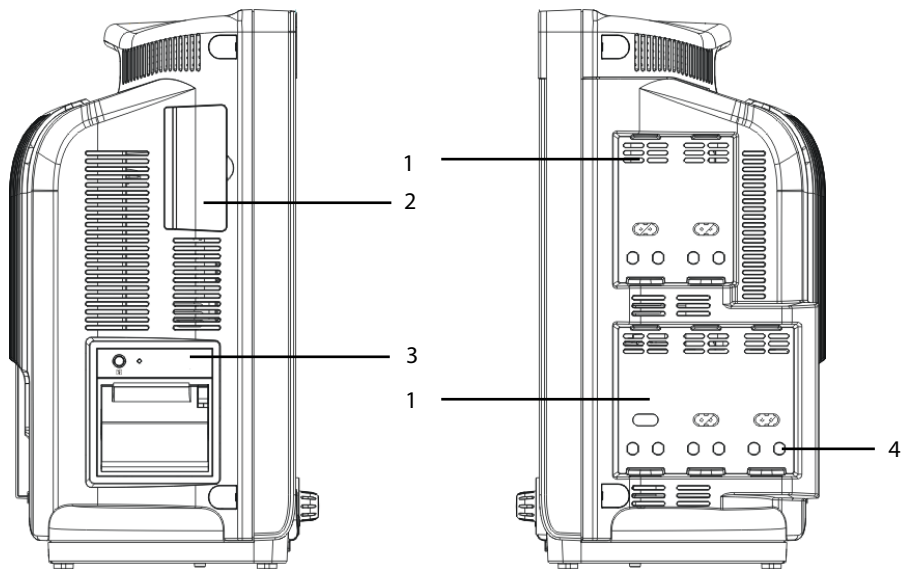

- 1. Integral Module Racks
- 2. Compartment for CF storage card slot
- 3. Recorder
- 4. Contact

NOTE

- To ensure good contact, clean the contacts regularly, as dust and dirt may collect on them. When cleaning the contacts, wipe them with cotton, dampened with alcohol. Using forceps is recommended.

2.2.3 Rear View

Passport 12m

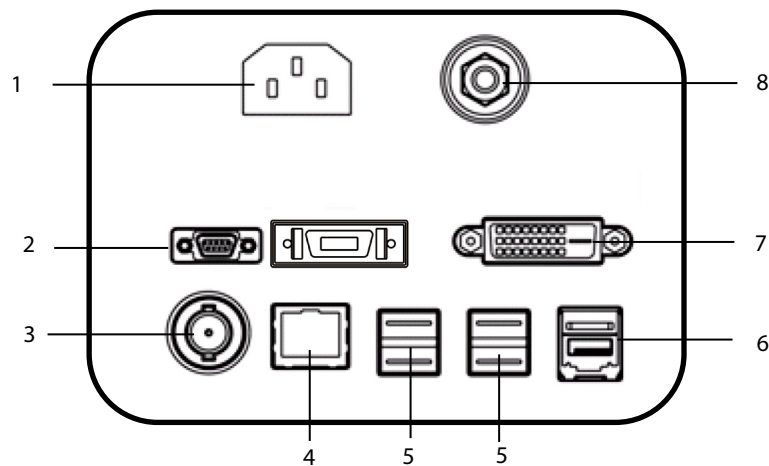
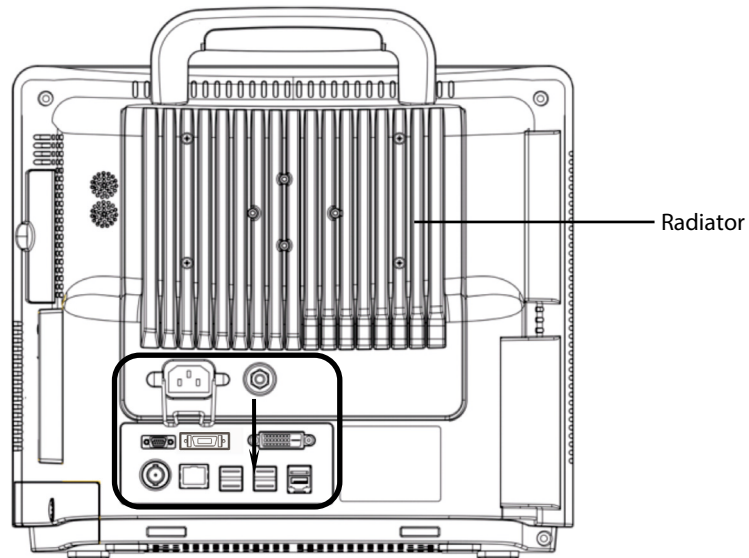

1. AC Power Input
2. Micro-D Connector: outputs analog ECG, IBP and defibrillator synchronization signals simultaneously, among which the ECG signals support pace pulses to be enhanced.
3. Nurse Call Connector: connects the patient monitor to the hospital's nurse call system through the nurse call cable (**PN: 8000-21-10361**). Alarms are sent to nurses through the nurse call system, if configured to do so.
4. Network Connector: a standard RJ45 connector which connects the monitor to the central monitoring system (CMS) or other monitor for remote view through the LAN. It can also be used to transmit data.
5. USB Connectors: connect such devices as the USB mice, USB keyboard, etc.
6. SMR Connector: connects the satellite module rack (SMR), the T1 docking station, or the N1 Dock.

7. Digital Video Interface (DVI): connects a secondary display, which extends the display capability of your monitor. The contents displayed on the secondary display screen matches what displays on the monitor screen.
8. Equipotential Grounding Terminal: when using the monitor together with other devices, connect their equipotential grounding terminals together to eliminate the potential differences between them.

Passport 17m

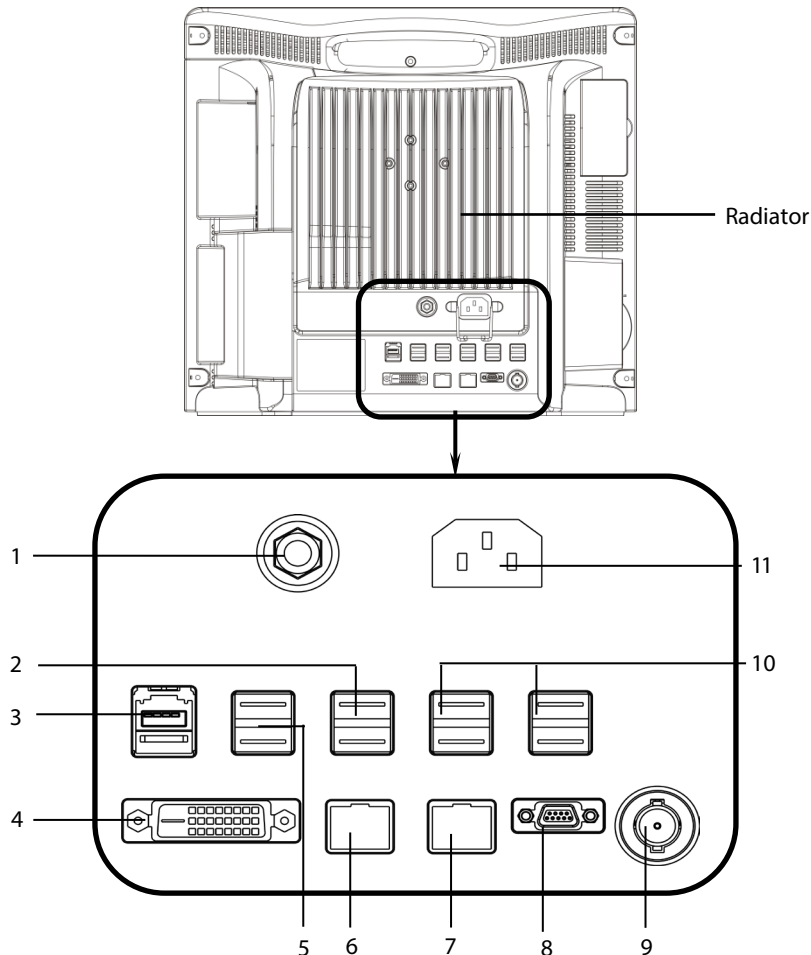

1. Equipotential Grounding Terminal: when using the monitor together with other devices, connect their equipotential grounding terminals together to eliminate the potential differences between them.
2. USB Connectors: only used for iView maintenance and data transfer.
3. SMR Connector: connects the satellite module rack (SMR), the T1 docking station, or the N1 Dock.
4. Digital Video Interface (DVI): connects a secondary display, which extends the display capability of your monitor. The secondary display can be independently operated and controlled, and also display the contents different from the monitor screen.
5. USB Connectors: connect the controlling devices (USB mouse and USB keyboard) of the secondary display.

6. iView Network Connector: a standard RJ45 connector which connects the iView system to external network.
7. Network Connector: a standard RJ45 connector which connects the monitor to the central monitoring system (CMS) or other monitor for remote view through the LAN. It can also be used to transfer data.
8. Micro-D Connector: outputs analog ECG, IBP and defibrillator synchronization signals simultaneously, among which the ECG signals supports pace pulses to be enhanced.
9. Nurse Call Connector: connects the monitor to the hospital's nurse call system through the nurse call cable (**PN: 8000-21-10361**). Alarms are sent to nurses through the nurse call system, if configured to do so.
10. USB Connectors: connect such devices as the USB mouse, USB keyboard, etc.
11. AC Power Input

2.2.4 Bottom View (Passport 17m)

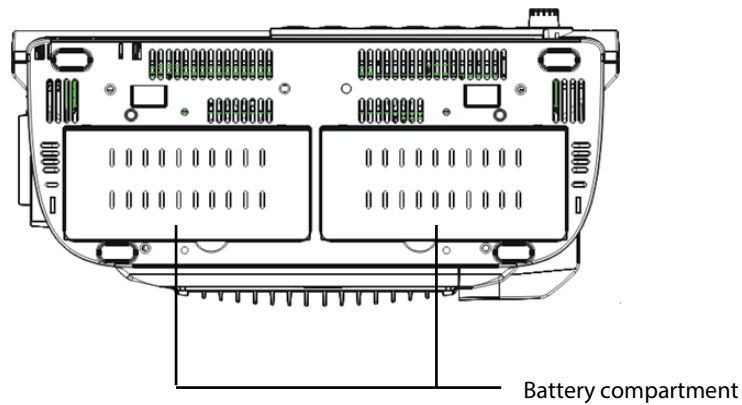

2.3 Satellite Module Rack

Two types of Satellite Module Racks (SMR) can be connected to the monitor through the SMR connector via a SMR cable. One type is the OEM SMR and the other type is the Mindray SMR. Both of these SMRs provide 8 slots for mounting measurement modules. The number of modules mounted in the SMR depends on the types of modules, as different modules consume a different number of slots.

The following figures show the indicator and connectors on the OEM SMR.

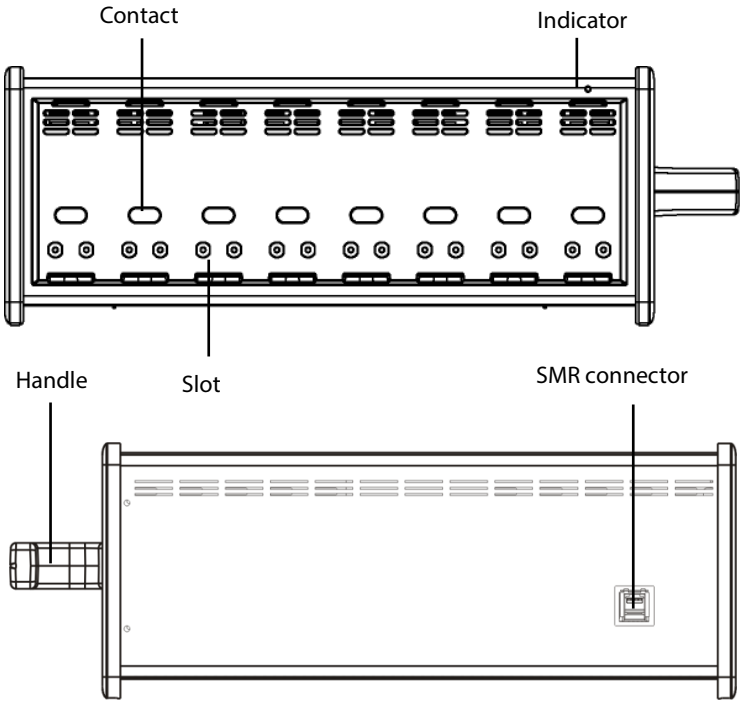

The following figures show the indicator and connectors on the Mindray SMR.



SMR connector: only the SMR 1 port is for use with the Passport 12m/17m monitors

As shown in the figures above, there is an indicator showing the status of the SMR:

- On: when the SMR works normally.
- Off: when the SMR disconnects from the monitor, there is a problem with the power, or the monitor shuts down.

NOTE

- **To ensure a good contact, clean the contacts regularly, as dust and dirt may collect on them. When cleaning the contacts, wipe them with cotton, dampened with alcohol. Using forceps is recommended.**

2.4 Modules

As shown below, the monitor supports the following modules:



- SpO₂ module: Pulse oxygen saturation module.
- MPM: Multi-parameter module. It can simultaneously monitor ECG, respiration, SpO₂, temperature, NIBP and IBP. Refer to section **2.4.1 Multi-Parameter Module** for more information.
- IBP module: Invasive blood pressure module.
- C.O. module: Cardiac output module.
- CCO/SvO₂ module: CCO/SvO₂ interface module, used to interface with Edwards Vigilance II® monitor, Vigileo™ monitor, or EV1000 monitor.
- CO₂ module: Carbon dioxide module (including sidestream and microstream).
- AG module: Anesthesia gas module. The functions of the O₂ modules can be incorporated into it.
- BIS module: Bispectral index module.
- RM module: Respiration mechanics module.
- ScvO₂ module: Central venous oxygen saturation module.
- T1: Used as a multi-measurement module for monitoring ECG, respiration, SpO₂, temperature, NIBP and IBP. Refer to section **2.4.2 T1** for more information.
- BeneLink module: BeneLink module is used for transmitting information from a connected external device to the monitor.
- NMT module: Neuromuscular transmission module.
- N1: Used as a multi-measurement module for monitoring ECG, respiration, SpO₂, temperature, NIBP, IBP, and CO₂. Refer to section **2.4.3 N1** for more information.

Under the maximum configuration, the monitor has one two-slot module rack, one three-slot module rack and one satellite module rack. The number of modules mounted in the monitor depends on the types of modules, as different modules consume a different number of slots.

You can plug-in and unplug modules during patient monitoring. To plug- in a module, insert the module until the lever on the module clicks into place and then push the lock key at the bottom in position to lock the module. To unplug a module, release the lock key, press the lever upwards and pull the module out.

Make sure that the indicator on the module light is on after the module is plugged in.

2.4.1 Multi-Parameter Module

The multi-parameter module (MPM) incorporates multiple measurement modules. Two types of MPM modules can be connected to the Passport 17m or 12m monitor. These MPM modules are named as MPM 2.0 and MPM 3.0.

As shown below, the module name is located at the upper left corner, all hardkeys on the upper part, and all measurement connectors on the lower part. Other measurement modules look similar to the MPM.

■ Example MPM 2.0

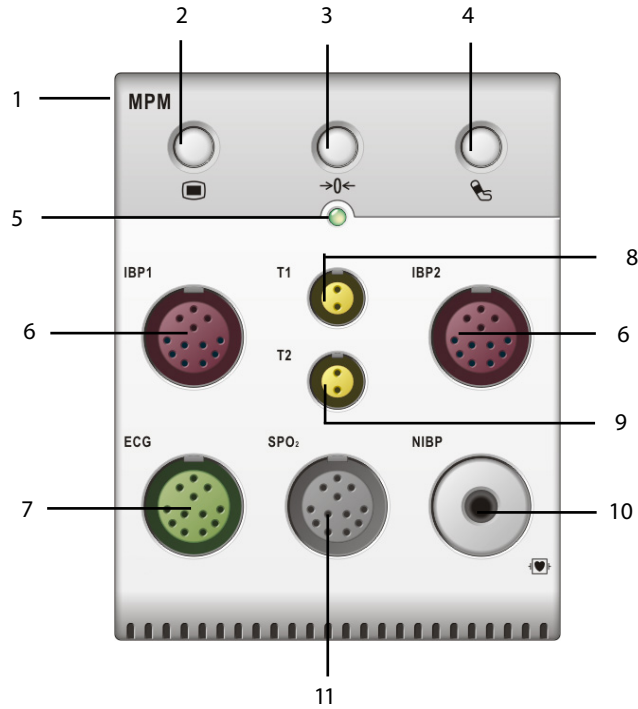

■ Example MPM 3.0

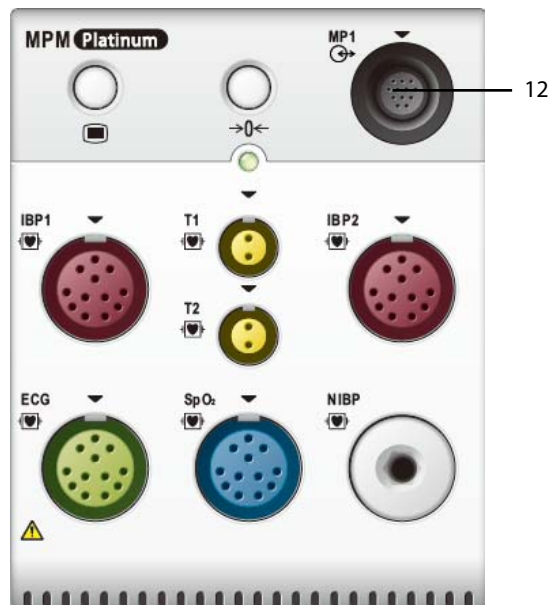

1. Module name
2. Setup key: press to enter the **[MPM Setup]** menu.
3. Zero key: press to enter the **[Zero IBP]** menu.
4. NIBP start/stop key: press to start or stop NIBP measurements.
5. Indicator
 - ◆ On: when the monitor works correctly.
 - ◆ Flash: when the module is being initialized.
 - ◆ Off: when the module is either disconnected or broken.
6. IBP cable connector
7. ECG cable connector
8. Temp probe 1 connector
9. Temp probe 2 connector
10. NIBP Cuff connector
11. SpO₂ cable connector
12. Analog out connector: outputs defibrillation synchronization pulse, ECG, and IBP analog signal.

NOTE

- **MPM 3.0 is supported by the software version 05.33.00 and above.**
 - **MPM 3.0 is only available for the U.S.**
-

2.4.2 T1

T1 can be connected to the Passport 17m or 12m monitor as a multi-measurement module.

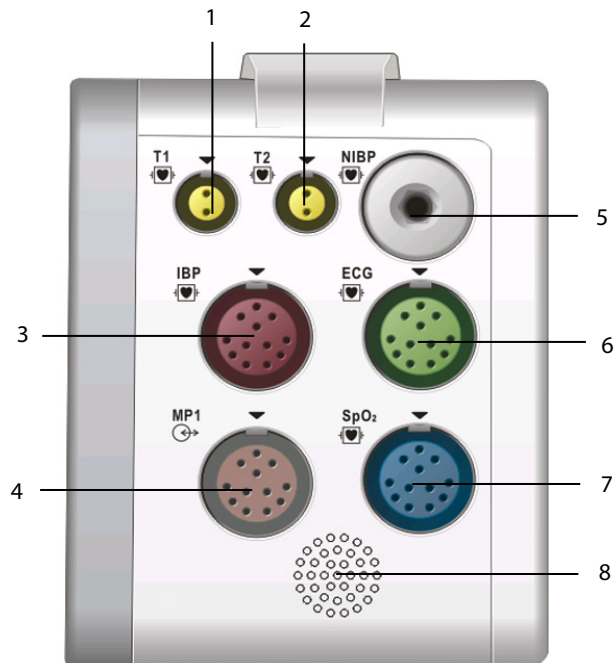

1. Temp probe 1 connector
2. Temp probe 2 connector
3. IBP cable connector
4. Multifunctional connector: outputs analog ECG, IBP and defibrillation synchronization signals.
5. NIBP cuff connector
6. ECG cable connector
7. SpO₂ cable connector
8. Speaker

When the T1 is disconnected from the Passport 12m or 17m, it can continue to monitor a patient as a stand-alone monitor running on battery power or external DC power supply. For details of using the T1 as a stand-alone monitor, refer to the **T1 Operating Manual** (PN: 046-006734-00).

NOTE

- **The Micro-D connector on the rear of the Passport 12m/17m monitor is disabled when the multifunctional connector of the T1 is in use.**
- **Please do not charge more than one T1 simultaneously with either the internal module rack or the satellite module rack.**

2.4.3 N1

2.4.3.1 Overview

BeneVision N1 patient monitor (hereinafter abbreviated as N1) can be connected to the Passport 17m or 12m monitor as a multi-measurement module.

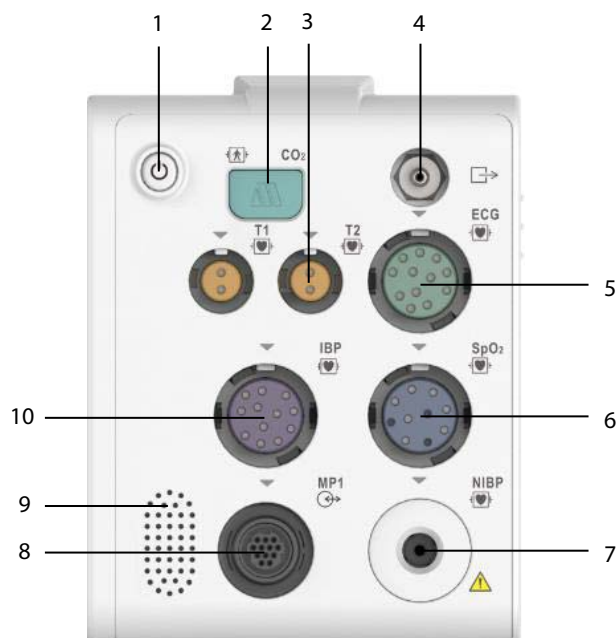

1. Power switch
2. Sample line connector of the sidestream CO₂
3. Temperature probe connector
4. Gas outlet
5. ECG cable connector
6. SpO₂ cable connector
7. NIBP cuff connector
8. Multifunctional connector: outputting analog ECG, IBP and defib synchronization signals.
9. Speaker
10. IBP cable connector

When the N1 is disconnected from the Passport 12m or 17m, it can continue to monitor a patient as a stand-alone monitor running on battery power or external DC power supply. For details of using the N1 as a stand-alone monitor, refer to the **N1 Operating Manual** (PN: 046-011405-00).

NOTE

- **The Micro-D connector on the rear of the Passport 12m/17m monitor is disabled when the multifunctional connector of the N1 is in use.**
- **Please do not charge more than one N1 simultaneously with either the internal module rack or the satellite module rack.**
- **The N1 is supported by the software version 05.33.00 and above.**
- **The N1 is only available for the U.S.**

2.5 Display Screen

This monitor adopts a high-resolution TFT LCD to display patient parameters and waveforms. A typical display screen is shown below.

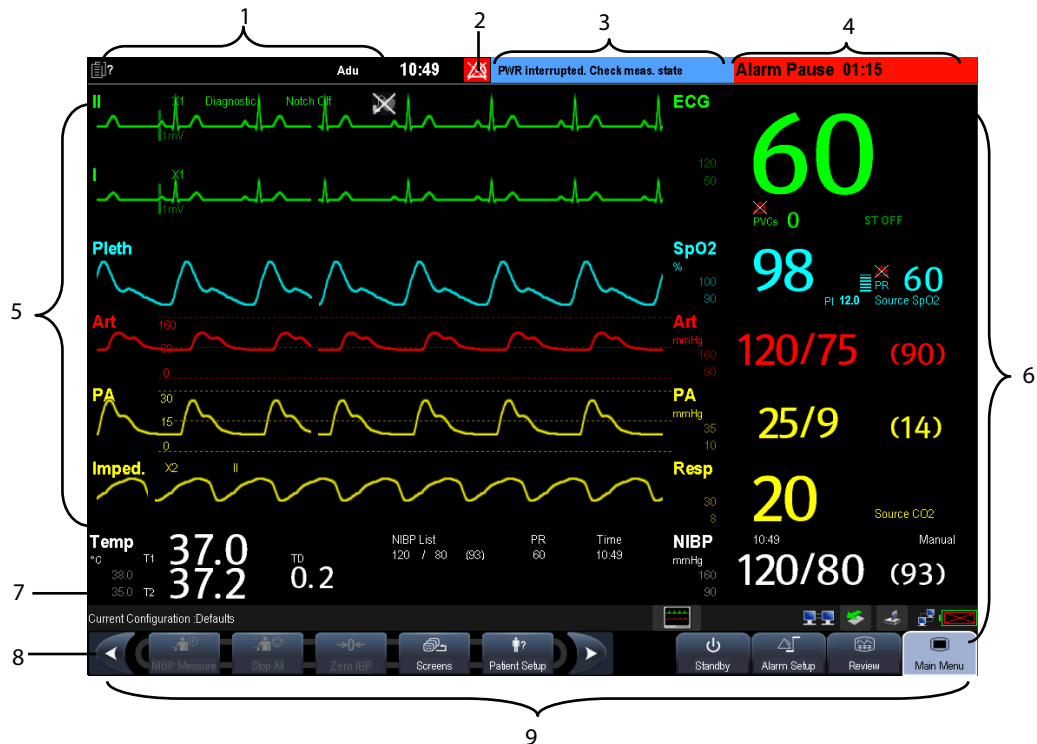

1. Patient Information Area

- ◆ This area shows the date, time, and the patient information such as department, bed number, patient name and patient category. indicates that no patient is admitted or the patient information is incomplete. If no patient is admitted, selecting this area enters the [Patient Setup] menu. For admitted patients, selecting this area enters the [Patient Demographics] menu.

2. Alarm Symbols

- ◆ indicates alarms are paused.
- ◆ indicates alarms are reset.
- ◆ indicates alarm sounds are turned off.
- ◆ indicates the system is in alarm off status.

3. Technical Alarm Area

This area shows technical alarm messages and prompt messages. When multiple messages occur, the messages scroll. Selecting this area shows the Technical Alarms list.

4. Physiological Alarm Area

This area shows physiological alarm messages. When multiple alarms occur, the messages scroll. Select this area and the physiological alarm list displays.

5. Waveform Area

This area shows measurement waveforms. The waveform name displays at the upper left corner of the waveform. Select this area and the corresponding measurement setup menu displays.

6. Parameter Area A

This area shows measurement parameters. Each monitored parameter has a parameter window and the parameter name displays at the upper left corner. The corresponding waveform of each parameter is displayed in the same row in the waveform area. Select this area and the corresponding measurement setup menu displays.

7. Parameter Area B

For the parameter values displayed in this area, their corresponding waveforms are not displayed.

8. Prompt Message Area

This area shows the prompt messages, network status icons, battery status icons, etc.

For Passport 12m, this area shows the currently selected CMS if the [Select CMS] function is enabled. If no CMS is selected, this area displays "???". Refer to section **0 Selecting a CMS** for detail.

For details about battery status symbols, refer to chapter **32 Batteries**.

◆  indicates the monitor is successfully connected to a wired network.

◆  indicates the monitor has failed to connect to a wired network.

◆  indicates the wireless function (optional) is connected.

◆  indicates the wireless function (optional) is not connected.

◆  indicates a CF storage card is inserted.

◆  indicates a USB drive is inserted.

◆  indicates a secondary display is connected.

◆  [Screen Setup] button

9. QuickKeys Area

This area contains QuickKeys that provide quick access to functions.

























2.6 QuickKeys









A QuickKey is a configurable graphical key, located at the bottom of the main screen. They give you fast access to functions. Their availability, and the order in which they appear on your screen, depend on your monitor configuration.

To configure QuickKeys:

1. Select **[Main Menu]**→**[Maintenance >>]**→**[Manage Configuration >>]**→enter the required password→**[Ok]**.
2. In the **[Manage Configuration]** menu, select **[Edit Config.>>]**.
3. In the pop-up menu, select the desired configuration and then select **[Edit]**.
4. In the pop-up menu, select **[Screen Setup >>]**.
5. Select the **[Select QuickKeys]** tab, and then configure your desired QuickKeys and the order of them.

The following QuickKeys are available:

	Scroll left to display more QuickKeys.		Scroll right to display more QuickKeys.
	[Main Menu] QuickKey Enter the [Main Menu]		[Standby] QuickKey Enter standby mode
	[Alarm Setup] QuickKey Enter the [Alarm Setup] menu		[Review] QuickKey Enter the [Review] menu
	[NIBP Measure] QuickKey Enter the [NIBP Measure] menu		[Stop All] QuickKey Stop all NIBP measurement
	[Zero IBP] QuickKey Enter the [Zero IBP] menu		[Alarm Reset] QuickKey Reset the alarm system
	[Alarm Pause] QuickKey Pause or restore alarms		[Screens] QuickKey Enter the [Screens] menu
	[Patient Setup] QuickKey Enter the [Patient Setup] menu		[Manual Event] QuickKey Trigger a manual event
	[Realtime Print] QuickKey Start the realtime print		[Print Setup] QuickKey Enter the [Print Setup] menu
	[Minitrends] QuickKey Have a split-screen view of minitrends		[Volume Setup] QuickKey Enter the [Volume Setup] menu
	[Load Config.] QuickKey Enter the [Load configuration] menu		[iView] QuickKey (For Passport 17m only) Have the iView
	[Start C.O.] QuickKey Enter the C.O. measurement window		[Loops] QuickKey View respiratory loops
	[Calculations] QuickKey Enter the [Calculations] menu		[Others] QuickKey Enter the [View Other Patient] window
	[7-Lead ECG] QuickKey Enter the 7-lead ECG full screen		[12-Lead ECG] QuickKey Enter the 12-lead ECG full screen

	[Parameters] QuickKey Enter the [Parameters] menu		[OxyCRG] QuickKey Enter the [oxyCRG] window
	[NIBP STAT] QuickKey Start NIBP STAT measurement		[PAWP] QuickKey Enter the PAWP measurement screen
	[Night Mode] QuickKey Enter the [Night Mode] menu		[Unit Setup] QuickKey Enter the [Unit Setup] menu
	[Privacy Mode] QuickKey Enter the privacy mode		[CPB Mode] QuickKey Enter the CPB mode
	[Discharge Patient] QuickKey Enter the [Discharge Patient] menu		

NOTE

- There is space for only 12 user configurable Quickkeys on the Passport 17m, and 10 user configurable Quickkeys on the Passport 12m.

3 Basic Operations

3.1 Installation

WARNING

- **Connect only approved devices to this equipment. Devices connected to the equipment must meet the requirements of the applicable IEC standards (e.g. IEC 60950 safety standards for information technology equipment and IEC 60601-1 safety standards for medical electrical equipment). The system configuration must meet the requirements of the IEC 60601-1 medical electrical systems standard. Any personnel who connect devices to the equipment's signal input/output port are responsible for providing evidence that the safety certification of the devices has been performed in accordance to the IEC 60601-1. If you have any questions, please contact Mindray.**
 - **If it is not evident from the equipment specifications whether a particular combination with other devices is hazardous, for example, due to summation of leakage currents, please consult the manufacturer or an expert in the field. A determination must be made that the proposed combination will not negatively affect the devices themselves or the patient's safety.**
 - **Use only screws and brackets specified by Mindray, or the screw could touch the internal battery, causing monitor damage.**
-
-

CAUTION

- **The equipment should be installed by authorized Mindray personnel.**
-

NOTE

- **The software equipment copyright is solely owned by Mindray. No organization or individual shall resort to modifying, copying, or exchanging it or to any other infringement on it in any form or by any means without due permission.**
 - **Many settings in the patient monitor are password protected. It is recommended to change the default passwords and keep the passwords safe. Passwords should only be changed by authorized personnel. Contact your department manager or biomedical engineering department for the passwords used at your facility.**
-

3.1.1 Unpacking and Checking

Before unpacking, examine the packing case carefully for signs of damage. If any damage is detected, contact the carrier or Mindray.

If the packing case is intact, open the package and remove the equipment and accessories carefully. Check all materials against the packing list and check for any mechanical damage. Contact Mindray in case of any problem.

CAUTION

- **When disposing of the packaging material, be sure to observe the applicable waste control regulations and keep it out of children's reach.**
 - **Before use, please verify whether the packages are intact, especially the packages of single use accessories. In case of any damage, do not apply it to patients.**
-

NOTE

- **Save the packing case and packaging material as they can be used if the equipment must be reshipped.**
-

3.1.2 Environmental Requirements

The equipment operating environment must meet the requirements specified in this manual.

The equipment operating environment should be reasonably free from noises, vibration, dust, corrosive, flammable and explosive substances. To maintain good ventilation, the equipment should be at least 2 inches (5 cm) away from surrounding objects.

When the equipment is moved from one place to another, condensation may occur as a result of temperature or humidity difference. In this case, never start the system before the condensation disappears.

CAUTION

- **Make sure that the equipment operating environment meets the specific requirements. Otherwise unexpected consequences, e.g. damage to the equipment, could result.**
-

3.2 Getting Started

3.2.1 Connecting to Power Source

Using AC Power Source

To use the AC power source, connect one end of the power cord with the AC power input on the equipment's back panel and the other end with a wall AC mains outlet.

WARNING

- **Always use the accompanying power cord with the monitor.**
 - **Use the battery if the integrity of the protective earth conductor or the protective earthing system in the installation is in doubt.**
-
-

Using a Battery

This monitor can be equipped with rechargeable lithium-ion battery. If a battery is installed, the monitor system automatically switches to the battery for power if AC power is interrupted.

NOTE

- **When a battery has been stored for a long time, or the battery is depleted, recharge the battery at once. Otherwise, the low battery may not be sufficient to power the monitor if the AC power is unavailable.**
-

Refer to chapter **32 Batteries** for details.

Connecting Accessories

Insert the connector of accessory cables necessary for the measurements to be performed by your monitor to the corresponding connector on the monitor. For details about the parameter connectors, refer to section **2.4 Modules**.

3.2.2 Turning Power On

Once the monitor is installed, before beginning measurements:

1. Check the monitor, SMR and plug-in modules for any mechanical damage, and make sure that all external cables, plug-ins and accessories are properly connected.
2. Check the power supply specification is met if mains power is used. Only use a power outlet that is properly grounded.
3. Plug the power cord into the AC power source. If you run the monitor on battery power, ensure that the battery is sufficiently charged.
4. Press the power on/off switch on the monitor's front panel.

The monitor will perform alarm system self-test during start-up. After pressing the power on/off button, the system sounds a beep and the alarm lamp simultaneously turns yellow, then red, and then turns off, followed by the start-up screen being shown. Then the start-up screen disappears. The alarm system self-test succeeds. The monitor enters the normal monitoring screen.

WARNING

- **Do not use the monitor on a patient if you suspect it is not working properly, or if it is mechanically damaged. Contact your service personnel or Mindray.**
-

NOTE

- **Carefully check if the system performs the self-test as described above. Contact your service personnel or Mindray if the self-test is abnormal.**
-

3.2.3 Starting Monitoring

To start monitoring:

1. Decide which measurements you want to take.
2. Connect the required modules, patient cables and sensors.
3. Make sure that the patient cables and sensors are correctly connected.
4. Make sure that the patient settings, such as [**Patient Cat.**], [**Paced**], etc, are appropriate for your patient.
5. Refer to the appropriate measurement section for details of how to perform the measurements you require.

3.3 Turning Off the Monitor

Before turning off the monitor:

1. Ensure that the monitoring of the patient has been completed.
2. Disconnect the cables and sensors from the patient.
3. Make sure to save or clear the patient monitoring data as required.
4. Press and hold the power on/off switch for more than 2 seconds to turn off the monitor. "**System is shutting down...**" is displayed on the screen and then the monitor shuts down.

CAUTION

- **Press and hold the power on/off switch for 10 seconds to forcibly shut down the monitor if it could not be shut down normally. This may cause loss of patient data.**
- **The monitor restores the latest configuration if it restarts within 60 seconds after a power failure. The monitor restores the default configuration, rather than the latest configuration, if it restarts 120 seconds after a power failure. The monitor may load either the latest configuration or the default configuration if it restarts from 60-120 seconds after a power failure.**
- **Power failure may cause data corruption on the SD card. It is recommended to turn off the monitor according to the normal procedures. Do not unplug the power cord unless charged battery/batteries are installed. To operate on DC power, the Passport 12m requires one battery while the Passport 17m requires two batteries.**

NOTE

- **To completely disconnect the power source, unplug the power cord and then remove the battery/batteries.**
-

3.4 Using the Knob

- Rotate the knob clockwise or counterclockwise to move the cursor.
- Press the knob to select one item, such as accessing a menu or confirming the selection.

3.5 Using a Mouse

You can use the USB mouse supplied with the equipment as a monitor input device. The USB mouse can be plugged and unplugged with the monitor turned on.

When you are using a mouse:

- By default, the left mouse-button is the primary button and the right one the secondary button.
- Clicking the primary button is equal to pressing the knob or selecting the touchscreen.
- The secondary button is disabled.

To define the right mouse-button as the primary button:

1. Select [**Main Menu**]→[**Maintenance >>**]→[**User Maintenance >>**]→enter the required password.
2. Select [**Others >>**] to enter the [**Others**] menu.
3. Select [**Primary Button**] and then select [**Right**] from the pop-up list.





3.6 Using Keys

The monitor has three types of keys:

- Softkey: A softkey is a graphic key on the screen, giving you fast access to certain menus or functions. The monitor has two types of softkeys:
 - ◆ Parameter keys: Each parameter area can be seen as a softkey. You can enter a parameter setup menu by selecting its corresponding parameter or waveform area.
 - ◆ QuickKeys: QuickKeys are configurable graphical keys, located at the bottom of the main screen. For details, refer to the section **2.6 QuickKeys**.
- Hardkeys: A hardkey is a physical key on a monitoring device, such as the [**Main Menu**] key on the monitor's front panel.
- Pop-up Keys: Pop-up keys are task-related keys that appear automatically on the monitor screen when needed. For example, the Confirm pop-up key appears only when you need to confirm a change.

3.7 Using the On-screen Keyboard

The on-screen keyboard enables you to enter information.

- Use the  key to delete the previously entered character.
- Use the  key to toggle between uppercase and lowercase letters.
- Select  to confirm what you have entered and close the on-screen keyboard.
- Select  to access the symbol keyboard.
- Select  to exit the symbol keyboard.

3.8 Using the Touchscreen

Select screen items by pressing them directly on the patient monitor's screen. You can enable or disable touchscreen operation by pressing and holding the **[Main Menu]** QuickKey for 3 seconds. A padlock symbol  displays if touchscreen operation is disabled.

3.9 Using the [Main Menu]

To enter the **[Main Menu]**, select the  on-screen QuickKey or the **[Menu]** hardkey on the monitor's front panel. Most of monitor operations and settings can be performed through the **[Main Menu]**.

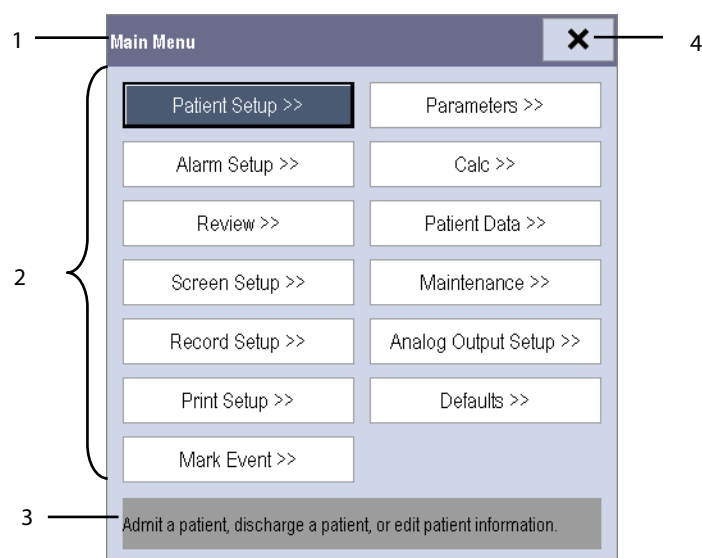

Other menus are similar to the **[Main Menu]** and contain the following parts:

1. Heading: describes the title for the current menu.
2. Main body: displays options, buttons, prompt messages, etc. The menu button with ">>" open a secondary window to reveal more options or information.
3. Online help area: displays help information for the highlighted menu item.
4. : select to exit the current menu. If changes are made in the menu, they take effect after selecting this button.

3.10 Setting the Screen

You can enter the **[Screen Setup]** window as shown below by selecting the **[Screen Setup]** icon  in the prompt message area. In this window, you can arrange the position of the parameters and waveforms. Unselected parameters or waveforms will not display.

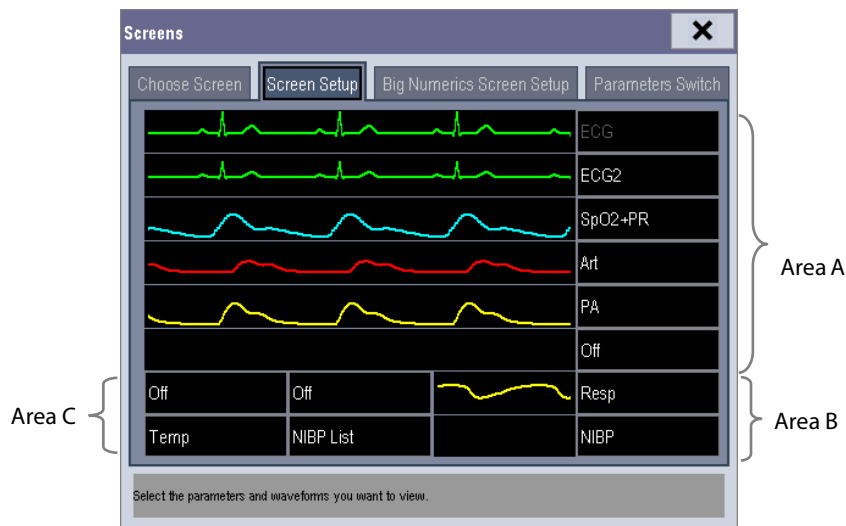

The ECG parameter and the first ECG waveform always display in the first row. The configurable areas can be classified as Area A, Area B, and Area C.

- In Area A, you can choose to display the parameter windows and their waveforms (if one exists). Each parameter and the associated waveform are displayed in the same row.
- In Area B, you can choose to display the parameter windows. But if all parameters in area C are set to **[Off]**, both the parameter and waveform selected in the first row of area B will be displayed.
- In Area C, you can choose to display the timer and any parameters without associated waveforms.

The screen automatically adjusts to ensure the best view based on your screen setup.

If no corresponding parameter or waveform is displayed after the module is inserted, perform the following inspections:



- Check the connection between the module and lead, cable, sensor, or external device.
- Check whether the **[The display setup for XX is disabled]** message is displayed in the prompt message area and the **[Screen Setup]** icon  is flashing. If yes, select this icon to enter the **[Screen Setup]** window for the desired display configuration.
- Check that the parameter is turned on in **[Parameters Switch]** window.

CAUTION

- **Unallocated parameters in the [Screen Setup] window will not display. However, the monitor still sounds alarms for these parameters.**
-

3.11 Displaying the Timer

To display the timer in the main screen:

1. Select the **[Screens]** button  in prompt message area to access the **[Screens]** window.
2. Select **[Screen Setup]** tab.
3. In the Area C, select **[Timer]** from the drop-down list of the desired parameter area. Refer to section **3.10 Setting the Screen** for Area C.
4. Select  to exit the window. The main screen will display the timer.

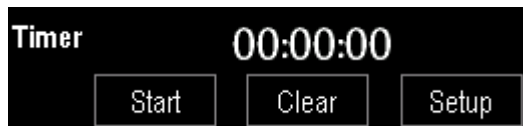

- Select **[Start]** or **[Pause]** to start or pause timing.
- Select **[Clear]** to clear current timing result.
- Select **[Setup]** to access the **[Timer Setup]** window, in which you can set the **[Direction]** to **[Up]** or **[Down]**. If you select **[Down]**, you should set:
 - ◆ **[Run Time(h:min:s)]**: The available time range is 0 to 100 hours, and the default time is 5 minutes.
 - ◆ **[Reminder Vol]**: During the last 10 seconds of the countdown, the system issues reminder tone. The available volume range is 0 to 10. 0 means off, and 10 the maximum volume.

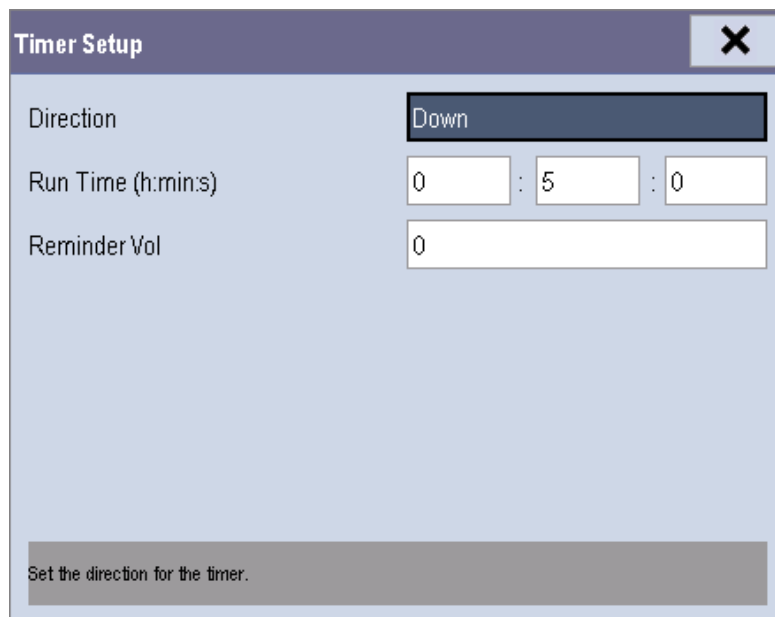

3.12 Changing General Settings

This chapter covers only general settings such as language, brightness, date and time, etc. Refer to measurement and other settings in their respective sections.

3.12.1 Setting up a Monitor

To install a monitor or change its location:

1. Select **[Main Menu]**→**[Maintenance >>]**→**[User Maintenance >>]**→enter the required password.
2. In the **[User Maintenance]** menu, select, **[Monitor Name]**, **[Department]** and **[Bed No.]** or edit their settings.

3.12.2 Changing Language

To change the language:

1. Select **[Main Menu]**→**[Maintenance >>]**→**[User Maintenance >>]**→enter the required password.
2. In the **[User Maintenance]** menu, select **[Language]** and then select the desired language.
3. Restart the monitor.

NOTE

-
- **The changed language is applied only after the monitor is restarted.**
-

3.12.3 Adjusting the Screen Brightness

To adjust the screen brightness:

1. Select the **[Main Menu]**→**[Screen Setup >>]**→**[Brightness]**.
2. Select the appropriate setting for the screen brightness. 10 is the brightest, and 1 is the dimmest.

If the monitor operates on battery power, setting a dimmer screen brightness will prolong the battery operating time. When the monitor enters Standby mode, the screen automatically changes to the dimmest setting.

3.12.4 Showing/Hiding the Help Text

The monitor provides online help information. The user can display or hide the help text as needed.

1. Select **[Main Menu]**→**[Screen Setup >>]**.
2. Select **[Help]** and select either **[On]** or **[Off]**.

3.12.5 Setting the Date and Time

To set the date and time:

1. Select **[Main Menu]** →**[Maintenance >>]**→**[System Time >>]**.
2. Set the date and time.
3. Select **[Date Format]** and then select **[yyyy-mm-dd]**, **[mm-dd-yyyy]** or **[dd-mm-yyyy]**.
4. Select **[Time Format]** and then select **[24h]** or **[12h]**.

If your monitor is connected to a central station (CMS), the date and time are automatically synchronized to that CMS. In that case, you cannot change the date and time settings on your monitor.

CAUTION

- **Changing date and time affects the storage of trends and events and may cause data loss. Save or record any needed data prior to changing the date and time.**
-

3.12.6 Adjusting Volume

Alarm Volume

To adjust the alarm volume:

1. Select the **[Volume Setup]** QuickKey, or **[Main Menu]**→**[Alarm Setup >>]**.
2. Input the password as required. See section **31.7.2 Selecting Password for User Authentication**.
3. Select **[Others]** tab.
3. Select **[Alm Volume]** and then select the appropriate volume: X-10, in which X is the minimum volume, depending on the set minimum alarm volume (refer to **section 7.4.1 Setting the Minimum Alarm Volume**), and 10 is the maximum volume.

Key Volume

When you press the navigation knob, the touchscreen, or the hardkeys on the panel, the monitor prompts you by making a sound of the key volume you have set.

To adjust the key volume:

1. Select the **[Volume Setup]** QuickKey, or **[Main Menu]**→**[Screen Setup >>]**.
2. Select **[Key Volume]** and then select the appropriate volume. 0 means off, and 10 is the maximum volume.

QRS Volume

The QRS tone is derived from either the HR or PR, depending on which is currently selected as the alarm source in **[ECG Setup]** or **[SpO₂ Setup]**. When monitoring SpO₂, there is a variable pitch tone which changes as the patient's saturation level changes. The tone pitch rises as the saturation level increases and falls as the saturation level decreases. The tone volume is user adjustable.

To adjust the QRS volume:

1. Select the **[Volume Setup]** QuickKey, or the ECG parameter window→**[Others >>]**, or the SpO₂ parameter window.
2. Select **[QRS Volume]** or **[Beat Vol]** and then select the appropriate volume. 0 means off, and 10 is the maximum volume.

3.13 Setting Parameters

3.13.1 Switching the Parameters On/Off

To switch the parameters on or off, select **[Main Menu]**→**[Screen Setup >>]**→**[Screen Layout >>]**→**[Parameters Switch]**, or **[Screens]** QuickKey →**[Parameters Switch]**. When a parameter is switched off, its corresponding parameter module stops working, and its parameter value and waveform are not shown on the monitor display.

NOTE



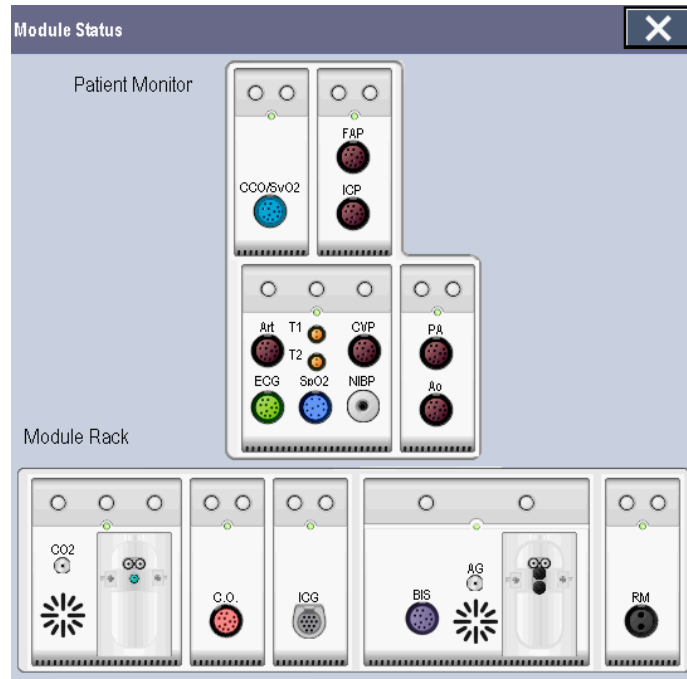

-
- **ECG is always selected, and you can not switch it off.**
-

3.13.2 Accessing the Parameters Menu

Select [**Parameters >>**] from the [**Main Menu**] or select the [**Parameters**] QuickKey at the bottom of the screen to enter the [**Parameters**] menu where you can access each parameter's setup menu. You can further select [**Module Status >>**] to enter the menu as shown below. Your display may be configured to look slightly different depending on the modules mounted.



This menu displays the measurement modules mounted in the two-slot module rack, three-slot module rack and satellite module rack from top to bottom. Beside each measurement connector is the measurement label. The color in which a measurement connector appears matches the status as follows:

-  (colored) indicates that the module is turned on.
-  (grey) indicates that the module is turned off.
-  indicates a module name conflict.
-  indicates a module error.

3.13.3 Removing a Module Conflict

Generally, the monitor can support only one type of parameter modules simultaneously. Otherwise, the module conflict message will be prompted. For example, if a CO₂ module is already loaded and then another CO₂ module is inserted, your monitor will display a module conflict. To use one module, just pull the other module out.

But for IBP measurements, it can support three independent IBP modules and the IBP module on the MPM simultaneously, while for SpO₂ monitoring, it can support one independent SpO₂ module and the SpO₂ module on the MPM simultaneously.

3.14 Using a CF Storage Card

A CF storage card is used to save patient data such as trend data, waveform data, etc., during patient monitoring. In case of a sudden power failure, the patient data can be retrieved from the CF storage card after the monitor restarts.

To insert a CF storage card, open the compartment and then insert the card until the button pops out.

To remove the CF storage card:

1. In the **[Main Menu]**, select **[Unload Storage Card]**, or **[Patient Data]** → **[Unload Storage Card]**. You can also click



icon in the lower right corner of the screen.

2. Select **[Ok]** from the pop-up menu to unload the CF storage card. A status message shown in the prompt message area will report completion of the unloading.
3. Press the button until the CF storage card pops out.

To browse the data saved in the CF storage card:

1. Select **[Main Menu]** → **[Patient Data >>]** → **[Historical Data >>]**.
2. Select a patient whose data you want to view from the **[Patient Data List]** and then select **[Review]**.
3. Select **[Data Review]**.

As reviewing the patient's data history is just like reviewing the patient's current data, you can refer to the chapter **27 Review** for details.

CAUTION

- **Unload the CF storage card before removing it from the monitor. Otherwise it may cause damage to the data in the card.**
- **Use only the CF storage card specified by Mindray.**
- **Please take measures against the static electricity by wearing a wrist strap when you remove the CF card.**

NOTE

- **If no CF storage card is used, all the data saved to the internal memory will be lost in case of monitor shut-down or sudden power interrupt.**
 - **The system deletes the oldest data stored in the CF card automatically when the remaining space is insufficient.**
-

3.15 Operating Modes

Your monitor has different operating modes. Some are password protected. This section lists the major operating modes.

3.15.1 Monitoring Mode

This is the normal, everyday working mode that you use for monitoring patients. Your monitor automatically enters the Monitoring mode after being turned on.

3.15.2 Night Mode

To avoid disturbing the patient, Night mode may be used.

To activate the Night mode:

1. Select the **[Night Mode]** QuickKey or **[Main Menu]**→**[Screen Setup >>]**→**[Night Mode >>]**.
2. In the pop-up menu, set the desired brightness, alarm volume, QRS volume, key volume, NIBP end tone, or whether to stop NIBP measurements or not. When **[Stop NIBP]** is selected, all the NIBP measurements terminate after entering the Night mode.
3. Select the **[Enter Night Mode]** button.

To cancel the Night mode:

1. Select the **[Night Mode]** QuickKey or **[Main Menu]**→**[Screen Setup >>]**→**[Night Mode >>]**.
2. Select **[OK]** in the pop-up.

CAUTION

- **Before entering Night mode, confirm the brightness settings, alarm volume, QRS volume, and key volume. Consider the potential risk when the setting value is low.**
-

3.15.3 Privacy Mode

Privacy mode is only available when an admitted patient at a monitor is also monitored by the CMS.

To activate the Privacy mode, select [**Main Menu**]→[**Screen Setup >>**]→[**Privacy Mode**].

The monitor does the following after activating Privacy mode:

- The screen turns blank and the message [**Under monitoring. Press any key to exit the privacy mode.**] displays.
- Monitoring and data storing continue but patient data is only visible at the CMS.
- Alarms can still be triggered. But all audible alarms are suppressed and the alarm light is deactivated at the monitor.
- All system sounds are suppressed, including heart beat tone, pulse tone, all prompt tones, etc.

To cancel the privacy mode, press any key.

The monitor exits the Privacy mode automatically in any of the following situations:

- The monitor disconnects from the CMS.
- The alarm [**Battery Too Low**] or [**System will shut down soon. Please replace the batteries or use the external power.**] is presented.

The touchscreen is locked automatically in the Privacy mode.

WARNING

- **In Privacy mode, all audible alarms are suppressed and the alarm light is deactivated at the monitor. Alarms sound only at the CMS.**

NOTE

- **The Privacy mode can be used only when the monitor is connected to a CMS.**
-

3.15.4 Standby Mode

In Standby mode, you can temporarily stop patient monitoring without turning off the monitor. To enter the Standby

mode, select the [**Standby**] QuickKey .

FOR YOUR NOTES

4 Managing Patients

4.1 Admitting a Patient

The monitor displays and stores physiological data in trends as soon as a patient is connected. This allows you to monitor a patient that is not admitted yet. However, it is recommended that you admit a patient so that you can clearly identify them on recordings, reports and networking devices.

To admit a patient:

1. Select the **[Patient Setup]** QuickKey, or **[Main Menu]**→**[Patient Setup >>]**.
2. Select **[Admit Patient]**.

If a patient has previously been admitted, a message **[Are you sure to discharge the current patient and admit a new patient?]** pops up. Then select **[Ok]** to clear any previous patient data. If you do not erase data from the previous patient, the new patient's data is combined with the previous patient's data. The monitor makes no distinction between the old the new patient data.

If no patient has been previously admitted, you can choose either:

- ◆ **[Yes]** to apply the data saved in the monitor to the new patient, or
 - ◆ **[No]** to clear the data saved in the monitor.
3. In the **[Patient Demographics]** menu, enter the demographic details, of which:
 - ◆ **[Patient Cat.]** allows the user to select patient size (Neo, Ped, Adu) which will determine the way your monitor processes and calculates some measurements, and what safety and alarm limits are applied for your patient.
 - ◆ **[Paced]** determines whether to show pace pulse marks on the ECG waveform. When the **[Paced]** is set to **[No]**, pace pulse marks are not shown in the ECG waveform.
 4. Select **[Ok]**.

WARNING

- **Make sure the [Patient Cat.] and [Paced] fields always contain a value, regardless of whether the patient is fully admitted or not.**
 - **For paced patients, you must set [Paced] to [Yes]. If it is incorrectly set to [No], the monitor could mistake a pace pulse for a QRS and fail to alarm when the ECG signal is too weak.**
 - **For non-paced patients, you must set [Paced] to [No].**
-

For details about patient paced status, refer to section **8.3.4 Checking Paced Status**.

4.2 Quick Admitting a Patient

Use **[Quick Admit]** only if you do not have the time or information to fully admit a patient. Complete the rest of the patient demographic details later. Otherwise, the  symbol always displays in the patient information area.

1. Select the **[Patient Setup]** QuickKey, or **[Main Menu]→[Patient Setup >>]**.
2. Select **[Quick Admit]**. If a patient has been admitted, select **[Ok]** to discharge the current patient. If no patient is admitted, you can choose either:
 - ◆ **[Yes]** to apply the data in your monitor to the new patient, or
 - ◆ **[No]** to clear any previous patient data.
3. Enter the Patient Category and Paced Status for the new patient, and then select **[Ok]**.

4.3 Setting the Monitor Location

To set the monitor location, follow this procedure:

1. Select **[Main Menu]→[Maintenance >>]→[User Maintenance >>]**→enter the required password.
2. Input the following location of the monitor:
 - ◆ **[Facility]**: your facility name.
 - ◆ **[Department]**: your department name.
 - ◆ **[Room No.]**: room number.
 - ◆ **[Bed No.]**: bed number.

4.4 Querying and Obtaining Patient Information

The monitor can obtain patient information from Hospital Information System (hereafter called HIS) through the eGateway. To query or obtain patient information from the HIS:

1. Select **[Main Menu]→[Maintenance >>]→[User Maintenance >>]**→enter the required password→**[Network Setup >>]→[Gateway Comm Setup >>]**, and set **[IP Address]** and **[Port]**. Set **[ADT Query]** to **[On]**. Then select **[Ok]**.
2. Select the patient information area to enter the **[Patient Demographics]** menu.
3. Select **[Obtain Patient Info. >>]** to enter the **[Obtain Patient Information]** menu.
4. Input a query condition and then select **[Query]**. The monitor displays the requested patient information.
5. Select a patient and then click **[Import]** to update the corresponding patient information.
6. Select  to exit the **[Obtain Patient Information]** menu.

NOTE

-
- The option **[Obtain Patient Information]** is available in the **[Patient Setup]** menu only when **[ADT Query]** is set to **[On]**.
 - When obtaining patient information from the HIS, only patient information is updated on the monitor. The patient's physiological data is not changed and the patient is not discharged.
-

4.5 Querying from Local Facility

You can query the patient information from either the local facility or all networked facilities. To set where to query, follow this procedure:

1. Select **[Main Menu]**→**[Maintenance >>]**→**[User Maintenance >>]**→enter the required password→**[Network Setup >>]**→**[Gateway Comm Setup >>]**.
2. Set **[Query From Local Facility]**.
 - ◆ Select **[Yes]** to query only from local facility.
 - ◆ Select **[No]** to query from all networked facilities.

4.6 Associating Patient Information

After associating patient information with the HIS, the monitor automatically updates the patient information if corresponding HIS information changes. The monitor can associate the patient's MRN (Medical Record Number), visit number, first name, last name, date of birth, and gender with the HIS.

NOTE

-
- **A keyword takes effect only when being defined in eGateway. Refer to *eGateway Integration Manager Installation Guide* (PN: 046-002447-00) for details.**
 - **The monitor displays corresponding patient information only when all the keywords have been entered.**
-

4.7 Editing Patient Information

To edit the patient information after a patient has been admitted, when the patient information is incomplete, or when you want to change the patient information:

1. Select the **[Patient Setup]** QuickKey, or **[Main Menu]**→**[Patient Setup >>]**.
2. Select **[Patient Demographics]** and then make the required changes.
3. Select **[Ok]**.

You can also input the patient's visit number in the **[Patient Demographics]** menu, but the **[Visit Number]** option needs to be enabled.

To display the **[Visit Number]** option in the **[Patient Demographics]** menu:

1. Select **[Main Menu]**→**[Maintenance >>]**→**[User Maintenance >>]**→enter the required password.
2. Set **[Visit Number]** to **[On >>]**.

4.8 Discharging a Patient

To discharge a patient:

1. Select the **[Discharge Patient]** QuickKey, or **[Main Menu]→[Patient Setup >>]→[Discharge Patient]**.
2. In the pop-up menu, you can either:
 - ◆ Select **[Ok]** to discharge the current patient, or
 - ◆ Select **[Standby]** then **[Ok]**. The monitor enters the standby mode after discharging the current patient, or
 - ◆ Select **[Cancel]** to exit without discharging the patient.

If you need to print the end case report, refer to section **30.7 End Case Reports** for instructions.

NOTE

- **After discharging an admitted patient, you can review the historical data of this patient by selecting [Main Menu]→[Patient Data >>]→[Historical Data >>]. When the CF card is full, the oldest patient data will be deleted automatically. Therefore, you cannot always view all the historical data.**
-

4.9 Transferring Patient Data

You can transfer a patient with an MPM, T1, or N1 to a new location without re-entering the patient demographic information or changing the settings. Transferring of patient data enables you to review the patient's condition history. The patient data that can be transferred includes: patient demographics, trend data, alarm events and parameter alarm limits. You can also use a USB drive or a CF storage card to transfer data between two monitors.

From the **[User Maintenance]** menu, select **[Others >>]**. In the pop-up menu, you can set **[Transferred Data Length]**. The default is **[4 h]**. You can also set **[Data Transfer Method]**. The default is **[Off]**.

WARNING

- **Do not discharge a patient before the patient is successfully transferred.**
 - **After a patient is successfully transferred, check if the patient settings (especially patient category, paced status and alarm limits settings, etc) on the monitor are appropriate for this patient.**
 - **Only when [Apply Module Settings] is set to [On] and select [Continue Patient in MPM] or [Continue Patient in Transfer Module], can the IBP labels be transferred along with the MPM/T1/N1.**
-

NOTE

- **The system automatically enables the HR alarm and lethal arrhythmia alarm after transferring the patient data.**
 - **The N1 is only available for the U.S.**
-

4.9.1 Transferring Patient Data via MPM/T1/N1

Familiarizing yourself with the data respectively stored in the monitor, T1, N1, or MPM helps you understand the effects incurred by transferring patients with an MPM/T1/N1.

Contents stored		In the patient monitor	In the MPM	In the T1	In the N1
Data	Patient demographics (Name, Bed No., Gender, etc.)	Yes	Yes	Yes	Yes
	Trend data	Yes	Yes	Yes	Yes
	Calculation data (Dose calculations, oxygenation calculations, etc.)	Yes	No	No	No
	Event data (Marked events, alarm events, etc.)	Yes	No	Yes	Yes
Settings	Monitor settings (Alarm pause, alarm volume, etc.)	Yes	No	No	No
	Parameter settings (Alarm limits, etc.)	Yes	Yes	Yes	Yes

Before transferring a patient with an MPM/T1/N1:

1. Select **[Main Menu]** → **[Maintenance]** → **[User Maintenance >>]** → enter the required password.
2. Select **[Others >>]**.
3. Set **[Data Transfer Method]** to **[Module]**.
4. Set **[Apply Module Settings]** to **[On]**. If your monitor does not have this option, the system applies the MPM/T1/N1's settings by default.
5. Set **[Data Transfer Strategy]** to:
 - ◆ **[Always Ask]**: when an MPM/T1/N1 is inserted to a monitor, the monitor displays a pop-up window asking the operator to choose what kind of data the monitor will apply.
 - ◆ **[Continue Module]**: when an MPM/T1/N1 is inserted to a monitor, the monitor will apply the data saved in the MPM/T1/N1.
 - ◆ **[Continue Monitor]**: when an MPM/T1/N1 is inserted to a monitor, the monitor will apply the data saved in the monitor.

To transfer the patient:

1. Disconnect MPM/T1/N1 from the original monitor.
2. Connect MPM/T1/N1 to the destination monitor.
3. If there is a mismatch between the MPM/T1/N1 and monitor, the system will automatically display the **[Select Patient]** menu, from which you can choose the data set you want to continue using for this patient, either:
 - ◆ **[Continue Patient in Monitor]**: continue with the patient data and settings in the monitor, deleting all patient data and settings in MPM/T1/N1 and copying all data in the monitor to MPM/T1/N1.
 - ◆ **[Continue Patient in MPM]** or **[Continue Patient in Transfer Module]**: continue with the patient data and settings in MPM/transfer module. The transfer module refers to T1 and N1. Discharge the patient in the monitor. The monitor then automatically admits the patient and copies all data from MPM/T1/N1.

- ◆ **[New Patient]**: select this button if none of the information is correct. This deletes all data in the monitor and MPM/T1/N1 and lets you admit a new patient on the monitor. In this case, you need to re-enter the patient demographics. The monitor will restore the settings according to the patient category.
- ◆ **[Same Patient]**: select this button if the patient demographics are different, but it is the same patient. This merges the patient's trend data in the monitor and MPM/T1/N1 and copies the settings in MPM/T1/N1 to the monitor also. It only appears when the critical patient information of an identical patient ID is different between the monitor and the MPM/T1/N1 module.

4. Select **[Ok]**.

Operations	Examples of applications
Continue Patient in Monitor	1. Replace MPM/T1/N1 during patient monitoring. 2. After the patient is admitted, connect the MPM/T1/N1.
Continue Patient in MPM/Continue Patient in Transfer Module	A patient is monitored using MPM/T1/N1. You need to transfer the patient, e.g. from a ward (original monitor) to the operating room (destination monitor).
New Patient	Connect the MPM/T1/N1 before admitting a new patient. However, the monitor and/or MPM/T1/N1 store the previous patient's data and settings.
Same Patient	A patient is admitted by a monitor, to which MPM/T1/N1 used in another monitor for monitoring this patient is connected.

4.9.2 Transferring Patient Data via a CF Storage Card or USB Drive

4.9.2.1 Transferring Data from the Monitor to a Storage Medium

To transfer data from the monitor to a storage medium:

1. Insert a storage medium into the monitor. Select **[Main Menu]**→**[Patient Setup >>]**.
2. Select **[Transfer to Storage Medium]**. In the pop-up menu, you can:
 - ◆ Select **[Ok]** to transfer the patient data, or
 - ◆ Select **[Cancel]** to exit the menu.
3. Wait until the following message appears: **[Transfer to storage medium successful. Please remove the CF storage card.]** or **[Transfer to storage medium successful. Please remove the USB drive.]**.
4. Remove the CF storage card or USB drive from monitor.

4.9.2.2 Transferring Data from the Storage Medium to the Monitor

To transfer data from a storage medium to the monitor:

1. Connect the storage medium to the destination monitor.
2. Select **[Main Menu]**→**[Maintenance >>]**→**[User Maintenance >>]**→enter the required password → **[Others >>]** → **[Data Transfer Method]** →**[USB Drive]** or **[Storage Card]**. Then:
 - ◆ Select **[Transfer]** to transfer the patient data to the monitor, or
 - ◆ Select **[Cancel Transfer]** to cancel the transfer operation.
 - ◆ Select **[Unload Storage Card]** or **[Unload USB Drive]** to unload the card or USB drive without transferring the patient data.

3. After you select **[Transfer]** in the pop-up menu, you can select the patient data contents that need to be transferred. **[Patient Demographics]** must be selected. After selecting **[Ok]**, the monitor compares the patient information stored in both the storage medium and monitor and manages the patient data based on the following:
 - ◆ **Different Patient:** The monitor erases all the current patient data, transfers the patient data from the storage medium, and loads the configuration according to the patient category.
 - ◆ **Same Patient:** In the pop-up dialog box, you can:
 - ◆ Select **[Yes]** to merge the patient data in the monitor and storage medium.
 - ◆ Select **[No]** to erase all the current patient data in the monitor and to transfer the patient data from the storage medium.
4. Wait until the message **[Transfer from storage medium successful.]** appears before removing the storage medium.

CAUTION

- **The USB drive you use may be write-protected. In this case, make sure the USB drive is in read/write mode.**
 - **Do not remove the storage medium during data transfer process. Otherwise, data files may be damaged.**
 - **The normal monitoring function will be affected during data export. Do not perform any monitoring activity during data export.**
-
-

4.10 Connecting to a CMS

The monitor supports connection to a CMS. If your monitor is connected to a CMS:

- All patient information, measurement data and settings on the monitor can be transferred to the CMS.
- All patient information, measurement data and settings can be displayed simultaneously on the monitor and CMS.
For some functions such as editing patient information, admitting a patient, discharging a patient, starting/stopping NIBP measurements, etc., bi-directional control can be achieved between your monitor and the CMS.

For details, refer to ***BeneVision Central Monitoring System Operator's Manual (PN: 046-007960-00 and PN: 046-010879-00)***.

FOR YOUR NOTES

5 Managing Configurations

5.1 Introduction

When performing continuous patient monitoring, the clinical professional often needs to adjust the monitor's settings according to the patient's condition. The collection of all these settings is called a configuration. Allowing you to configure the monitor more efficiently, the monitor provides different sets of configurations to accommodate the varying patient categories and departments. You can change the settings from a default configuration and then save it as a user configuration.

The default configurations provided for your monitor are department-oriented. You can choose either from:

- General
- OR
- ICU
- NICU
- CCU

Each department has three different sets of configurations one for each patient category [**Neo**], [**Ped**], and [**Adu**]. For the configuration items and their default values and user maintenance items, see Appendix **C Default Configurations**.

NOTE

- **The configuration management function is password protected. The configuration management tasks must be performed by authorized personnel. Please contact your department manager or biomedical engineering department for the password used at your facility.**
-

5.2 Accessing the [Manage Configuration] Menu

To access the [Manage Configuration] menu:

1. Press the [Menu] hardkey on the monitor's front panel to enter the [Main Menu].
2. Select [Maintenance >>] → [Manage Configuration >>]. Enter the required password and then select [Ok].

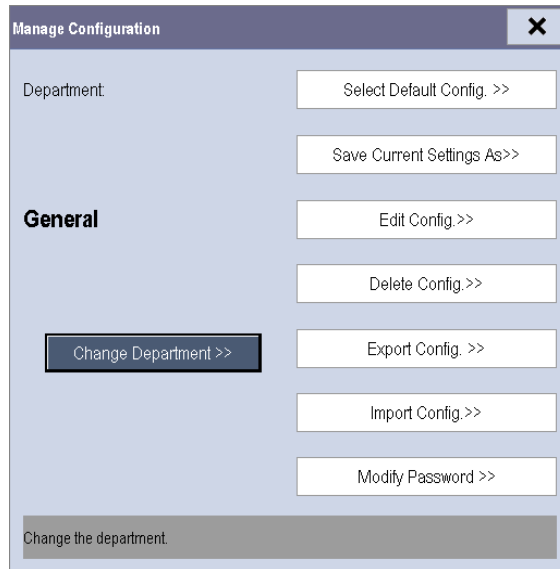

5.3 Changing Department

If the current department configuration is not the one you want to view, you can select [Change Department >>] in the [Manage Configuration] menu and then choose the one you want for viewing as shown below.

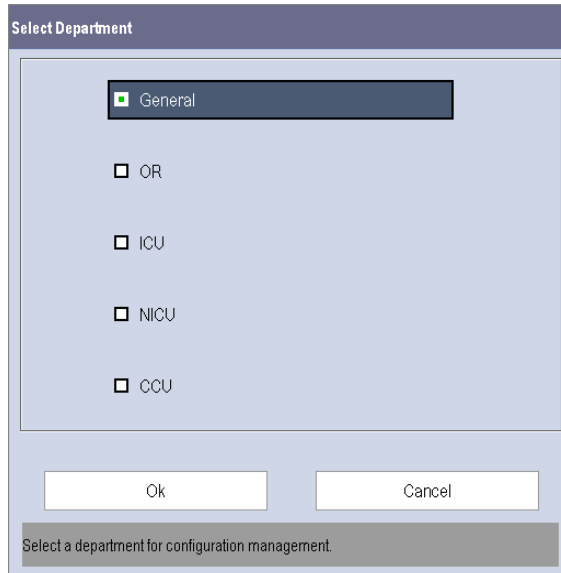

NOTE

- Changing the department will delete all current user configurations.

5.4 Setting Default Configuration

The monitor will load the pre-set default configuration in the following cases:

- The monitor restarts after being switched off for more than 120 seconds.
- A patient is admitted.
- A patient is discharged.
- Patient data is cleared.
- Patient category is changed.

To set the default configuration:

1. Select [**Select Default Config. >>**] in the [**Manage Configuration**] menu.
2. In the [**Select Default Config.**] menu, select [**Load the Latest Config.**] or [**Load Specified Config.**].

When you select [**Load Specified Config.**], the restored configuration is subject to the patient category (adult, pediatric or neonate). This configuration can be either factory configuration or a saved user configuration. As an example, select [**Default Adu Config.**] and then select [**Defaults**] or user configuration(s).

When you select [**Load the Latest Config**], the latest configuration is loaded when the monitor is started or a patient is admitted.

NOTE

- **To identify which configuration is restored when the monitor starts, enter the main screen to check the prompt information at the lower part of the screen.**
-

5.5 Saving Current Settings

Current settings can be saved as a user configuration. Up to 5 user configurations can be saved.

To save current settings:

1. Select [**Save Current Settings As >>**] in the [**Manage Configuration**] menu.
2. In the pop-up dialog box, enter the configuration name and then select [**Ok**]. The current settings are saved as a user configuration with the name you entered.

5.6 Editing Configurations

To edit an existing configuration:

1. Select [**Edit Config. >>**] in the [**Manage Configuration**] menu. The following menu appears.

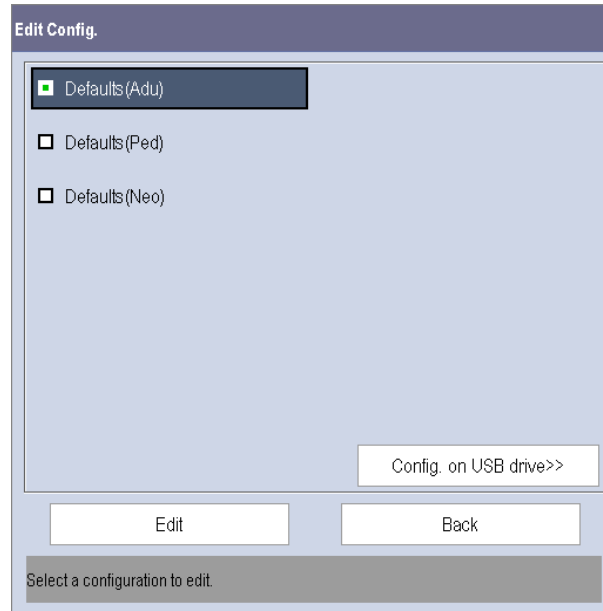

2. The pop-up menu shows the existing monitor configurations. Selecting [**Config. on USB drive >>**] will show the existing configurations on the USB drive. Select the desired configuration and then select the [**Edit**] button. The following menu appears.

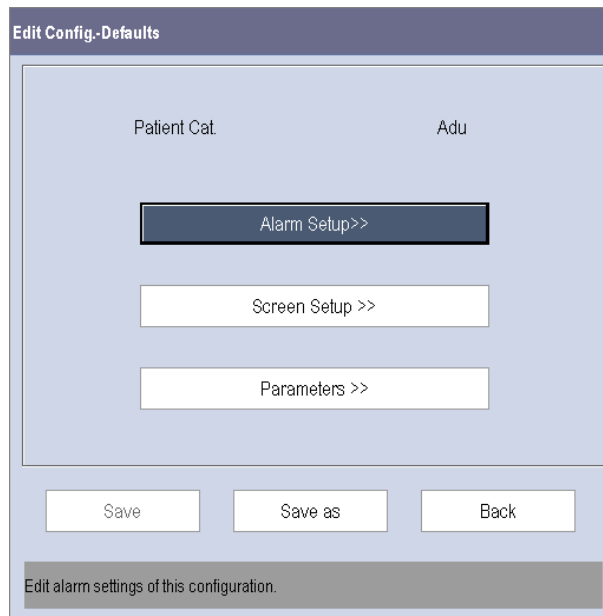

3. Select [**Alarm Setup >>**], [**Screen Setup >>**] or [**Parameters >>**] to enter the corresponding menu in which settings can be changed. The changed alarm setup items will be marked in red.
4. You can select [**Save**] or [**Save as**] to save the changed configuration. Select [**Save**] to overwrite the original configuration. Select [**Save as**] to save the changed configuration as another file with another name.

5.7 Deleting a Configuration

To delete a configuration:

1. Select [**Delete Config. >>**] in the [**Manage Configuration**] menu. The pop-up menu shows the existing user configurations on the monitor.
2. Select [**Config. on USB drive >>**] to show the existing user configurations on the USB drive. Select the user configurations you want to delete and then select [**Delete**].
3. Select [**Yes**] in the pop-up.

5.8 Transferring a Configuration

When installing several monitors with identical user configurations, it is not necessary to set each unit separately. Use a USB drive to transfer the configuration from monitor to monitor.

To export the current monitor's configuration:

1. Connect the USB drive to the monitor's USB port.
2. Select [**Export Config. >>**] in the [**Manage Configuration**] menu.

In the [**Export Config.**] menu, select the configurations and [**User Maintenance Settings**] to export. Then select the [**Export**] button. A status message will report completion of the transfer.

To import the configuration from the USB drive to the monitor:

1. Connect the USB drive to the monitor's USB port.
2. Select [**Import Config. >>**] in the [**Manage Configuration**] menu.
3. In the [**Import Config.**] menu, select the configurations and [**User Maintenance Settings**] to import. Then select the [**Import**] button. A status message will report completion of the transfer.

5.9 Loading a Configuration

You may make changes to some settings during operation. However, these changes or the pre-selected configuration may not be appropriate for the newly admitted patient. Therefore, the monitor allows you to load a desired configuration to ensure that all the settings are appropriate for your patient.

To load a configuration,

1. Select [**Load Configuration >>**] from the [**Main Menu**]. The pop-up menu shows the existing configurations on the monitor.
2. Select [**Config. on USB drive >>**] to show the existing configurations on the USB drive.
3. Select a desired configuration.
4. Select [**View**] to see the configuration details. In the pop-up menu, you can select [**Alarm Setup >>**], [**Screen Setup >>**] or [**Parameter >>**] to view the corresponding contents. The alarm setup items which are different than those currently used are marked in red.
5. Select [**Load**].

NOTE

- **The monitor may configure some settings by default when you load a configuration of different software version with the current configuration.**
-

5.10 Restoring the Latest Configuration Automatically

During operation, you may make changes to some settings. However, these changes may not be saved as a user configuration. To prevent the changes from being lost in case of a sudden power failure, the monitor stores the configuration in real time. The saved configuration is the latest configuration.

The monitor restores the latest configuration if it restarts within 60 seconds after the power failure. And it will restore the default configuration rather than the latest configuration if it restarts 120 seconds after the power failure. The monitor loads either the latest configuration or the default configuration if it restarts from 60-120 seconds after the power failure.

6 User Screens

6.1 Configuring Your Screens

You can configure your monitor's screens by setting:

- Waveform sweep mode
- Waveform line size
- The color in which each measurement's numerics and waveforms are displayed
- The parameter to monitor

CAUTION

- **Changing some settings may be hazardous. Therefore, those settings are password-protected and can be modified by authorized personnel only. Once a change is made, notify those who use the monitor.**
-

6.1.1 Changing the Waveform Line Size

To change the waveform line size:

1. Select **[Main Menu]** → **[Maintenance >>]** → **[User Maintenance >>]** → enter the required password.
2. Select **[Others >>]**.
3. Select **[Wave Line]** and select **[Thick]**, **[Med]** or **[Thin]**.

6.1.2 Changing Measurement Colors

To change the measurement colors:

1. Select **[Main Menu]** → **[Screen Setup >>]** → **[Measurement Color Setup >>]**.
2. Select the color box next to your desired parameter and then select a color from the pop-up menu.

6.1.3 Changing Screen Layout

Select the **[Screens]** QuickKey, or **[Main Menu]** → **[Screen Setup >>]** → **[Screen Layout >>]** to enter the **[Screens]** menu.

- You can choose the desired screen type in the **[Choose Screen]** window.
- You can select the parameters and waveforms you want to view in the **[Screen Setup]** window. For details, please refer to the section **3.10 Setting the Screen**.
- You can select the parameters you want to view on the big numerics screen in the **[Big Numerics Screen Setup]** window.
- You can switch the connected parameter modules on or off in the **[Parameters Switch]** window. If a parameter module is switched off, parameter values and waveforms will not display on the screen.

6.1.4 Setting the Waveform Sweep Mode

To set the waveform sweep mode:

1. Select **[Main Menu]**→**[Screen Setup >>]**.
2. Select **[Sweep Mode]** and then select **[Refresh]** or **[Scroll]**.
 - ◆ **[Refresh]**: The waveforms are refreshed from left to right.
 - ◆ **[Scroll]**: The waveforms move from the right to the left with time passing by.

6.2 Viewing Minitrends

6.2.1 Having a Split-Screen View of Minitrends

You can split the normal screen so that the left hand side continuously shows graphic minitrends beside waveforms as shown in the figure below.

To have a split-screen view of minitrends:

- Select the **[Minitrends]** QuickKey, or
- Select the **[Screens]** QuickKey  →**[Choose Screen]**→**[Minitrends Screen]**→**X**, or
- Select **[Main Menu]**→**[Screen Setup >>]**→**[Screen Layout >>]**→**[Choose Screen]**→**[Minitrends Screen]**→**X**.

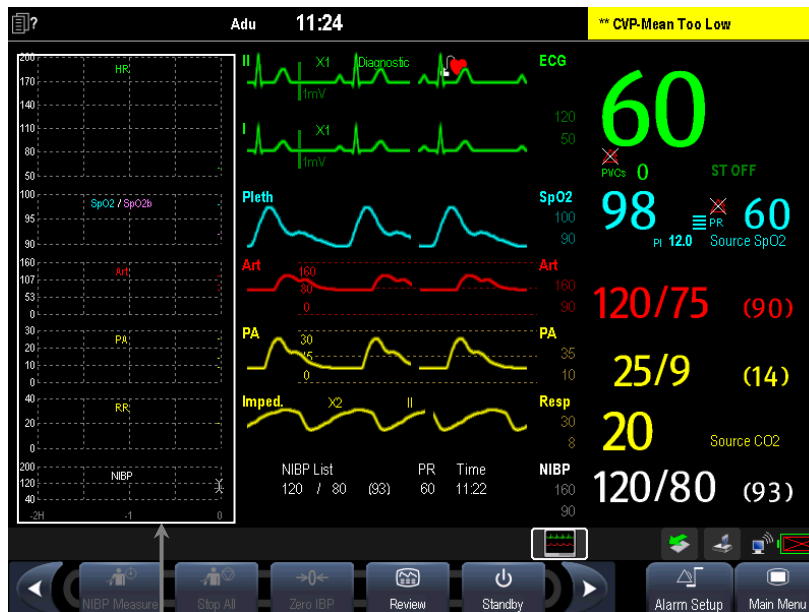

Minitrend View

The split-screen view provides minitrends for multiple parameters. In each field, the label and scale are respectively displayed at the top and left. The time is displayed at the bottom of the minitrends view as shown below.

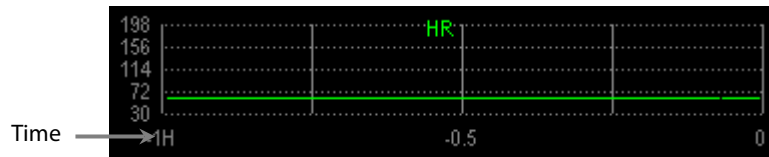

6.2.2 Setting Minitrends

Select the minitrends area. From the pop-up **[Minitrend Setup]** menu:

- Select the parameters to be displayed, or
- Select **[Minitrend Length]** and then select the appropriate setting.

6.3 Viewing OxyCRG

To have a split screen view of OxyCRG:

- Select the **[OxyCRG]** QuickKey, or
- Select the **[Screens]** QuickKey  → **[Choose Screen]** → **[OxyCRG Screen]** → **X**, or
- Select **[Main Menu]** → **[Screen Setup >>]** → **[Screen Layout >>]** → **[Choose Screen]** → **[OxyCRG Screen]** → **X**.

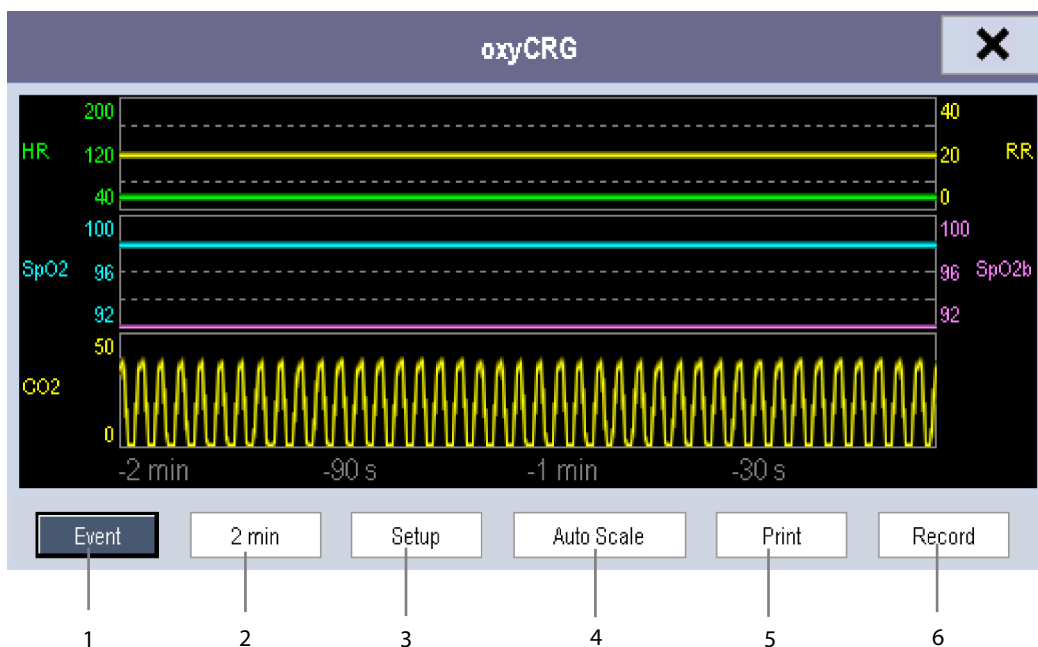

The split-screen view covers the lower part of the waveform area and shows HR trend, SpO₂ trend, SpO₂b trend, RR trend and a compressed waveform (CO₂ or Resp wave). At the bottom, there are controls:

1. Event

You can enter the **[Review]** menu by selecting the **[Event]** button.

2. Trend length list box

In the trend length list box, you can select **[1 min]**, **[2 min]**, **[4 min]**, or **[8 min]**.

3. Setup

Select the **[Setup]** button to enter the **[Setup]** menu, in which you can select the parameters for display, the time length to be saved before and after an event, and the scale of the graphic trends and waveform. The trend area can display two parameter trends, e.g. HR trend and RR trend, simultaneously.

4. Auto Scale

Select the **[Auto Scale]** button, and the system automatically adjusts the scaling.

5. Print

Select **[Print]** to print the real-time OxyCRG to a printer.

6. Record

Select **[Record]** to print the currently displayed OxyCRG trends to the recorder.

6.4 Viewing Other Patients

6.4.1 Care Group



The Passport 12m can support a Care Group of up to 10 monitors and the Passport 17m can support a Care Group of up to 16 monitors. This lets you:

- View information on the monitor screen from another bed in the same Care Group.
- Be notified of physiological and technical alarm conditions at the other beds in the same Care Group.

To have a Care Group:

1. Open the **[View Other Patient]** window by:

◆ Selecting **[Others]** QuickKey, or

◆ Selecting **[Screens]** QuickKey  → **[Choose Screen]** → **[View Others Screen]** → , or

◆ Selecting **[Main Menu]** → **[Screen Setup >>]** → **[Screen Layout >>]** → **[Choose Screen]** → **[View Others Screen]** → .

2. Select **[Setup]** in the **[View Other Patient]** window.

3. Select the desired monitors from the **[Connected Monitor List]**, and then select the  button. The selected monitors constitute a Care Group.

NOTE

- **Monitors using software version prior to 05.17.00 cannot view or be viewed by monitors of software version 05.17.00 or later.**
 - **Re-set the Care Group if the monitor is moved to a department or different LAN.**
-

6.4.2 Viewing the Care Group Overview Bar

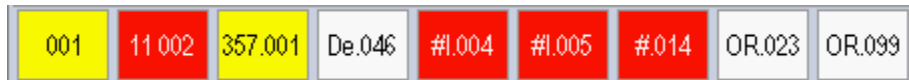

The Care Group overview bar is located at the bottom of the **[View Other Patient]** window. In the overview bar, the department and bed label for any Care Group beds are displayed. For telemetry, # is displayed before the department label. The color in which a Care Group bed appears matches its status:

- Red: indicates the bed is having high-level physiological alarms or the telemetry is in alarm, such as nurse call or event.
- Yellow: indicates the bed is having medium-level or low-level physiological alarms, or medium-level technical alarms.
- Blue: indicates the bed is having low-level technical alarms.
- Light grey: indicates the bed fails to be networked.
- Dark grey: indicates the bed is in the Standby mode.

You can view a Care Group bed's alarms by selecting it from the Care Group, and you can select the **[View This Patient]** button to view the bed in the **[View Other Patient]** window.

For more details about Care Group alarms, refer to the Chapter **7 Alarms**.

6.4.3 Understanding the View Other Patient Window

When you first open the [View Other Patient] window, the monitor automatically selects a device from the network to display in the [View Other Patient] window.

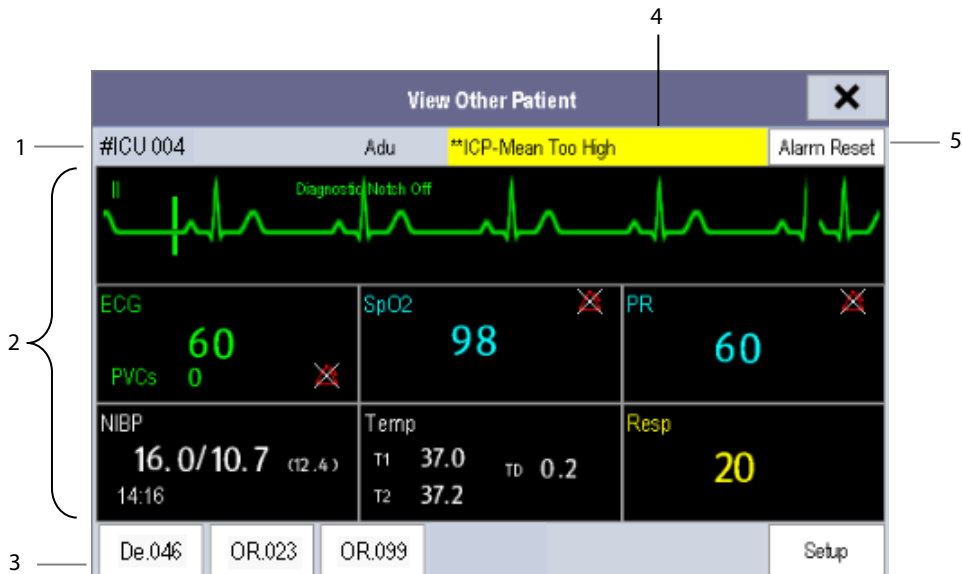

The [View Other Patient] window covers the lower part of the waveform area and consists of:

1. Information Area: shows the patient information (including department, bed number, patient name, etc.), and network status symbol.
2. View Area: shows physiological waveforms and parameters. You can switch a waveform area to a parameter area by selecting your desired waveform area and then selecting [Switch to Parameter Area], or switch a parameter area to a waveform area by selecting your desired parameter area and then selecting [Switch to Waveform Area].
3. Care Group Overview Bar. See section 6.4.2 Viewing the Care Group Overview Bar for more information.
4. Message Area: shows physiological, technical and prompt messages from the currently viewed patient monitor. It also shows the alarm given by the device such as nurse call or event. By selecting this area, you can enter the [Alarm Information List] to view all physiological, technical and prompt messages coming from the currently viewed patient.
5. [Alarm Reset] button: resets alarms from the currently viewed bed. Refer to section 7.11.3 Resetting Care Group Alarms.

When the [Reset Other Bed's Alarms] is disabled, no button will appear here.

Additionally, you can change a waveform or parameter for viewing:

- To change a waveform for viewing, select the waveform segment where you want a new waveform to appear and then select the waveform you want from the pop-up menu.
- To change a parameter for viewing, select the parameter window where you want a new parameter to appear and then select the parameter you want from the pop-up menu.

WARNING

- The data presented in the [View Other Patient] window has a delay. Do not rely on this window for realtime data.
 - The  icon indicates disconnection to the viewed monitor. You cannot view the monitor when this icon is displayed.
-

6.5 Understanding the Big Numerics Screen

To enter the big numerics screen:

1. Select the [Screens] QuickKey, or [Main Menu]→[Screen Setup >>]→[Screen Layout >>].
2. Select [Big Numerics]→.

You can select your desired parameters to display in this screen: select the [Screens] QuickKey→[Big Numerics Screen Setup] and then select the parameters you want. For parameters having a waveform, the waveform will also be displayed.

FOR YOUR NOTES

7 Alarms

Alarms, triggered by an abnormal vital sign or technical issue with the monitor, as visually and audibly indicated to the user.

WARNING

- **A potential hazard can exist if different alarm presets are used for the same or similar equipment in any single area, e.g. an intensive care unit or cardiac operating room.**
 - **If your monitor is connected to a CMS, alarms can be controlled remotely. Remote suspension, inhibition, and reset of monitor alarms via the CMS may cause a potential hazard. For details, refer to the CMS's operator's manual.**
-
-

For troubleshooting specific alarms, see appendix *D Alarm Messages*.

7.1 Alarm Categories

The monitor's alarms can be classified into two categories: physiological alarms and technical alarms.

1. Physiological alarms

Physiological alarms, also called patient status alarms, are triggered by a monitored parameter value that violates set alarm limits or an abnormal patient condition. Physiological alarm messages are displayed in the physiological alarm area.

2. Technical alarms

Technical alarms, also called system status alarms, are triggered by a device malfunction or a patient data distortion due to improper operation or mechanical problems. Technical alarm messages are displayed in the technical alarm area.

Apart from the physiological and technical alarm messages, the monitor will show some messages telling the system status or patient status. Messages of this kind are included in the prompt message category and usually displayed in the prompt information area. Some prompt messages that indicate the arrhythmia events are displayed in the physiological alarm area. For some measurements, their related prompt messages are displayed in their respective parameter windows.

7.2 Alarm Levels

The monitor's alarms can be classified into three severity categories: high level, medium level and low level.

	Physiological alarms	Technical alarms
High level	Indicate that the patient is in a life threatening situation, such as Asystole, Vfib/Vtac and so forth, and an emergency treatment is required.	Indicate a severe device malfunction or an improper operation which could make it possible that the monitor cannot detect critical patient status and thus threaten the patient's life.
Medium level	Indicate that the patient's vital signs appear abnormal and immediate treatment is required.	Indicate a device malfunction or an improper operation, which may not threaten the patient's life but may compromise the monitoring of vital physiological parameters.
Low level	Indicate that the patient's vital signs appear abnormal and immediate treatment may be required.	Indicate a device malfunction or an improper operation which may compromise a certain monitoring function but will not threaten the patient's life.

7.3 Alarm Indicators

When an alarm occurs, the monitor will indicate it to the user through visual or audible alarm indications.

- Alarm lamp
- Alarm message
- Flashing numerics
- Audible alarm tones

7.3.1 Alarm Lamp

If a technical alarm or physiological alarm occurs, the alarm lamp will flash. The color and flashing frequency match the alarm level as follows:

- High level alarms: the lamp quickly flashes red
- Medium level alarms: the lamp slowly flashes yellow
- Low level alarms: the lamp lights yellow without flashing

7.3.2 Alarm Messages

When an alarm occurs, an alarm message will appear in the technical or physiological alarm area. For physiological alarms, the asterisk symbols (*) before the alarm message match the alarm level as follows:

- High level alarms: ***
- Medium level alarms: **
- Low level alarms: *

Additionally, the alarm message has different background colors to match the alarm levels:

- High level alarms: red
- Medium level alarms: yellow
- Low level alarms: yellow

You can view the alarm messages by selecting the physiological or technical alarm area. Refer to section **2.5 Display Screen** for details.

7.3.3 Flashing Numeric

If an alarm triggered by an alarm limit violation occurs, the numeric of the measurement in alarm will flash every second, and the corresponding alarm limit will also flash at the same frequency indicating the high or low alarm limit is violated.

7.3.4 Audible Alarm Tones

The alarm tone is distinct from heart beat tone, keystroke tone and pulse tone in frequency. This monitor has three alarm tones and patterns: ISO, Mode 1 and Mode 2. For each pattern, the alarm tones identify the alarm levels as follows:





- ISO pattern:
 - ◆ High level alarms: triple+double+triple+double beep
 - ◆ Medium level alarms: triple beep
 - ◆ Low level alarms: single beep
- Mode 1:
 - ◆ High level alarms: high-pitched single beep
 - ◆ Medium level alarms: double beep
 - ◆ Low level alarms: low-pitched single beep
- Mode 2:
 - ◆ High level alarms: high-pitched triple beep
 - ◆ Medium level alarms: double beep
 - ◆ Low level alarms: low-pitched single beep

NOTE

- **When multiple alarms of different levels occur simultaneously, the monitor will select the highest level alarm, light the alarm lamp and give alarm sounds accordingly, while all the alarm messages are displayed circularly on the screen.**
 - **Some physiological alarms, such Asystole, are exclusive. They have identical alarm tones and alarm lights with normal high level physiological alarms, but their alarm messages are displayed exclusively. That is, when an exclusive physiological alarm and a normal high level physiological alarm are triggered simultaneously, only exclusive physiological alarm message will be displayed.**
-

7.3.5 Alarm Status Symbols

Apart from the aforementioned alarm indicators, the monitor still uses the following symbols telling the alarm status:

-  indicates alarms are paused.
-  indicates alarm is reset.
-  indicates the alarm sound is turned off.
-  indicates individual measurement alarms are turned off or the system is in alarm off status.

7.4 Alarm Tone Configuration

7.4.1 Setting the Minimum Alarm Volume

To set the minimum alarm volume:

1. Select [**Main Menu**]→[**Maintenance >>**]→[**User Maintenance >>**]→enter the required password.
2. Select [**Alarm Setup >>**] to enter the [**Alarm Setup**] menu.
3. Select [**Minimum Alarm Volume**] and then select a value between 0 and 10.

The minimum alarm volume refers to the minimum value you can set for the alarm volume, which is not affected by user or factory default configurations. The minimum alarm volume setting remains unchanged when the monitor shuts down and restarts.

7.4.2 Changing the Alarm Volume

To change the alarm volume:

1. Select the [**Volume Setup**] QuickKey or the [**Alarm Setup**] QuickKey→[**Others**], or [**Main Menu**]→[**Alarm Setup >>**]→enter the required password→[**Others**].
2. Select the appropriate volume from [**Alm Volume**]: X-10, in which X is the minimum volume, depending on the set minimum alarm volume, and 10 is the maximum volume.
3. Select [**High Alarm Volume**] to set the volume of the high priority alarm as [**Alm Volume+0**], [**Alm Volume+1**] or [**Alm Volume+2**].
4. Select [**Reminder Vol**] to set the volume of the reminder tone as [**High**], [**Med**] or [**Low**].

When alarm volume is set to 0, the alarm sound is turned off and a  symbol appears on the alarm symbols area of the screen.

7.4.3 Setting the Interval Between Alarm Sounds

If you choose the ISO pattern, you can change the interval between alarm tones. To change the interval between alarm tones:

1. Select **[Main Menu]**→**[Maintenance >>]**→**[User Maintenance >>]**→enter the required password.
2. Select **[Alarm Setup >>]** to enter the **[Alarm Setup]** menu.
3. Select **[High Alarm Interval (s)]**, **[Med Alarm Interval (s)]** and **[Low Alarm Interval (s)]** in order and then select the appropriate settings.

You cannot change the interval between alarm tones if you choose mode 1 or 2 as your desired alarm tone pattern. For these two patterns, the interval between alarm tones identifies the alarm levels as follows:

- Mode 1:
 - ◆ Interval between high level alarm tones: continuously
 - ◆ Interval between medium level alarm tones: 5 s
 - ◆ Interval between low level alarm tones: 20 s
- Mode 2:
 - ◆ Interval between high level alarm tones: 1 s
 - ◆ Interval between medium level alarm tones: 5 s
 - ◆ Interval between low level alarm tones: 20 s

WARNING

- **When the alarm sound is switched off, the monitor will give no audible alarm tones even if a new alarm occurs. Therefore the user should be very careful about whether to switch off the alarm sound or not.**
 - **Do not rely exclusively on the audible alarm system for monitoring. Adjustment of alarm volume to a low level may result in a hazard to the patient. Always keep the patient under close surveillance.**
-

7.4.4 Changing the Alarm Tone Pattern

To change the alarm tone pattern:

1. Select **[Main Menu]**→**[Maintenance >>]**→**[User Maintenance >>]**→enter the required password.
2. Select **[Alarm Setup >>]** to enter the **[Alarm Setup]** menu.
3. Select **[Alarm Sound]** and then select **[ISO]**, **[Mode 1]** or **[Mode 2]**.

NOTE

- **User or factory default configurations have no impact on the setup of alarm tone pattern. The alarm tone pattern remains unchanged after the monitor restarts.**
-

7.4.5 Setting the Reminder Tones

When the alarm volume is set to zero, or the alarm is reset or turned off, the monitor issues a periodic reminder tone.

To set the reminder tone:

1. Select **[Main Menu]** → **[Maintenance >>]** → **[User Maintenance >>]** → enter the required password.
2. Select **[Alarm Setup >>]** to enter the **[Alarm Setup]** menu.
3. Set the **[Reminder Tones]** to **[On]**, **[Off]** or **[Re-alarm]**. When **[Re-alarm]** is selected, the acknowledged physiological alarms and technical alarms marked with “√” will be re-generated after the **[Reminder Interval]** if the alarm condition persists.
 - ◆ To set the interval between reminder tones, select **[Reminder Interval]** and toggle between **[1min]**, **[2min]** and **[3min]**.

In addition, you can set the volume of alarm reminder tones. To set the volume of alarm reminder tones, select **[Main Menu]** → **[Alarm Setup >>]** → **[Others]** or the **[Alarm Setup]** QuickKey → **[Others]**. Then, select **[Reminder Vol]** and then select **[High]**, **[Medium]** or **[Low]**.

7.5 Understanding the Alarm Setup Menu

Select the **[Alarm Setup]** QuickKey or **[Main Menu]** → **[Alarm Setup >>]** to enter the **[Alarm Setup]**, where you can:

- Set alarm properties for all parameters.
- Change ST alarm settings.
- Change arrhythmia alarm settings.
- Set the threshold for some arrhythmia alarms.
- Change other settings.

The **[Alarm Setup]** menu as shown as below:

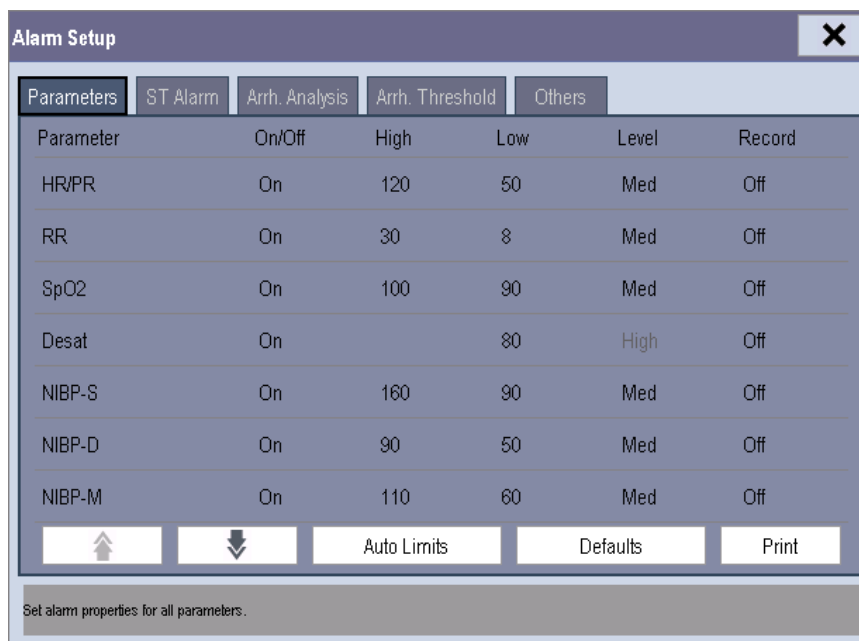

Parameter	On/Off	High	Low	Level	Record
HR/PR	On	120	50	Med	Off
RR	On	30	8	Med	Off
SpO2	On	100	90	Med	Off
Desat	On		80	High	Off
NIBP-S	On	160	90	Med	Off
NIBP-D	On	90	50	Med	Off
NIBP-M	On	110	60	Med	Off

Buttons: ↑ ↓ Auto Limits Defaults Print

Set alarm properties for all parameters.

Refer to chapter **8 Monitoring ECG** for how to change ST alarm settings, how to change arrhythmia alarm settings and how to set the threshold for some arrhythmia alarms.

7.5.1 Setting Alarm Properties for All Parameters

In the [Main Menu], select [Alarm Setup >>] → [Parameters]. You can review and set alarm limits, alarm switches, alarm level and alarm recordings for all parameters.

When a measurement alarm occurs, automatic recording of all the measurement numerics and related waveforms is possible when the measurement's [On/Off] and [Record] are set on.

WARNING

- **Make sure that the alarm limit settings are appropriate for your patient before monitoring.**
 - **Setting alarm limits to extreme values may cause the alarm system to become ineffective. For example, high oxygen levels may predispose a premature infant to retrolental fibroplasia. If this is a consideration, do NOT set the high alarm limit to 100%, which is equivalent to switching the alarm off.**
 - **When monitoring patients that are not continuously attended by a clinical operator, properly configure the alarm system and adjust alarm settings as per the patient's condition.**
-

7.5.2 Adjusting Alarm Limits Automatically

The monitor can automatically adjust alarm limits according to the measured vital signs. When auto limits are selected, the monitor calculates safe auto limits based on the latest measured values.

To get accurate auto alarm limits, you need to collect a set of measured vital signs as a baseline. Then, in the [Main Menu], select [Alarm Setup >>] → [Parameters] → [Auto Limits] → [Ok]. The monitor will create new alarm limits based on the measured values.

Before applying these automatically created alarm limits, confirm if they are appropriate for your patient in the [Alarm Setup] menu. If not, you can adjust them manually. These alarm limits will remain unchanged until you select auto limits again or adjust them manually.

The monitor calculates the auto limits based on the following guidelines.

Module	Parameter	Low alarm limit		High alarm limit		Auto alarm limits range
		Adult/ pediatric	Neonate	Adult/ pediatric	Neonate	
ECG	HR/PR	(HR × 0.8) or 40 bpm (whichever is greater)	(HR – 30) or 90 bpm (whichever is greater)	(HR × 1.25) or 240 bpm (whichever is smaller)	(HR + 40) or 200 bpm (whichever is smaller)	Adult/pediatric: 35 to 240 Neonate: 55 to 225
Resp	RR	(RR × 0.5) or 6 rpm (whichever is greater)	(RR – 10) or 30 rpm (whichever is greater)	(RR × 1.5) or 30 rpm (whichever is smaller)	(RR + 25) or 85 rpm (whichever is smaller)	Adult/pediatric: 6 to 55 Neonate: 10 to 90
SpO ₂	SpO ₂	Same as the default alarm limit	Same as the default alarm limit	Same as the default alarm limit	Same as the default alarm limit	Same as the measurement range

Module	Parameter	Low alarm limit		High alarm limit		Auto alarm limits range
		Adult/ pediatric	Neonate	Adult/ pediatric	Neonate	
NIBP	NIBP-S	$(SYS \times 0.68 + 10)$ mmHg	$(SYS - 15)$ or 45 mmHg (whichever is greater)	$(SYS \times 0.86 + 38)$ mmHg	$(SYS + 15)$ or 105 mmHg (whichever is smaller)	Adult: 45 to 270 Pediatric: 45 to 185 Neonate: 40 to 115
	NIBP-D	$(Dia \times 0.68 + 6)$ mmHg	$(Dia - 15)$ or 20 mmHg (whichever is greater)	$(Dia \times 0.86 + 32)$ mmHg	$(Dia + 15)$ or 80 mmHg (whichever is smaller)	Adult: 25 to 210 Pediatric: 25 to 150 Neonate: 20 to 90
	NIBP-M	$(Mean \times 0.68 + 8)$ mmHg	$(Mean - 15)$ or 35 mmHg (whichever is greater)	$(Mean \times 0.86 + 35)$ mmHg	$(Mean + 15)$ or 95 mmHg (whichever is smaller)	Adult: 30 to 230 Pediatric: 30 to 165 Neonate: 25 to 105
Temp	T1	$(T1 - 0.5) ^\circ C$	$(T1 - 0.5) ^\circ C$	$(T1 + 0.5) ^\circ C$	$(T1 + 0.5) ^\circ C$	1 to 49 °C
	T2	$(T2 - 0.5) ^\circ C$	$(T2 - 0.5) ^\circ C$	$(T2 + 0.5) ^\circ C$	$(T2 + 0.5) ^\circ C$	1 to 49 °C
	TD	Same as the default alarm limit	Same as the default alarm limit	Same as the default alarm limit	Same as the default alarm limit	Same as the measurement range
IBP: ART/ Ao/ UAP/ BAP/ FAP/ LV/ P1-P4 (Arterial pressure)	IBP-S	$(SYS \times 0.68 + 10)$ mmHg	$(SYS - 15)$ or 45 mmHg (whichever is greater)	$(SYS \times 0.86 + 38)$ mmHg	$(SYS + 15)$ or 105 mmHg (whichever is smaller)	Adult: 45 to 270 Pediatric: 45 to 185 Neonate: 35 to 115
	IBP-D	$(Dia \times 0.68 + 6)$ mmHg	$(Dia - 15)$ or 20 mmHg (whichever is greater)	$(Dia \times 0.86 + 32)$ mmHg	$(Dia + 15)$ or 80 mmHg (whichever is smaller)	Adult: 25 to 225 Pediatric: 25 to 150 Neonate: 20 to 90
	IBP-M	$(Mean \times 0.68 + 8)$ mmHg	$(Mean - 15)$ or 35 mmHg (whichever is greater)	$(Mean \times 0.86 + 35)$ mmHg	$(Mean + 15)$ or 95 mmHg (whichever is smaller)	Adult: 30 to 245 Pediatric: 30 to 180 Neonate: 25 to 105
PA	IBP-S	$SYS \times 0.75$	$SYS \times 0.75$	$SYS \times 1.25$	$SYS \times 1.25$	3 to 120 mmHg
	IBP-D	$Dia \times 0.75$	$Dia \times 0.75$	$Dia \times 1.25$	$Dia \times 1.25$	
	IBP-M	$Mean \times 0.75$	$Mean \times 0.75$	$Mean \times 1.25$	$Mean \times 1.25$	
IBP: CVP/ ICP/ LAP/ RAP/ UVP/ P1-P4 (Venous pressure)	IBP-M	$Mean \times 0.75$	$Mean \times 0.75$	$Mean \times 1.25$	$Mean \times 1.25$	3 to 40 mmHg

Module	Parameter	Low alarm limit		High alarm limit		Auto alarm limits range
		Adult/ pediatric	Neonate	Adult/ pediatric	Neonate	
CO ₂	EtCO ₂	0 to 32 mmHg: remains the same	0 to 32 mmHg: remains the same	0 to 32 mmHg: remains the same	0 to 32 mmHg: remains the same	Same as the measurement range
		32 to 35 mmHg: 29 mmHg	32 to 35 mmHg: 29 mmHg	32 to 35 mmHg: 41 mmHg	32 to 35 mmHg: 41 mmHg	
		35 to 45 mmHg: (etCO ₂ -6) mmHg	35 to 45 mmHg: (etCO ₂ -6) mmHg	35 to 45 mmHg: (etCO ₂ +6) mmHg	35 to 45 mmHg: (etCO ₂ +6) mmHg	
		45 to 48 mmHg:39 mmHg	45 to 48 mmHg:39 mmHg	45 to 48 mmHg:51 mmHg	45 to 48 mmHg:51 mmHg	
		>48 mmHg: remains the same	>48 mmHg: remains the same	>48 mmHg: remains the same	>48 mmHg: remains the same	
	FiCO ₂	N/A	N/A	Same as the default alarm limit	Same as the default alarm limit	Same as the measurement range
awRR	awRR × 0.5 or 6 rpm (whichever is greater)	(awRR – 10) or 30 rpm (whichever is greater)	awRR × 1.5 or 30 rpm (whichever is smaller)	(awRR+25) or 85 rpm (whichever is smaller)	Adult/pediatric: 6 to 55 Neonate: 10 to 90	
AG	EtCO ₂ (AG)	Same as CO ₂ module				
	FiCO ₂ (AG)					
	awRR	(awRR × 0.5) or 6 rpm (whichever is greater)	(awRR – 10) or 30 rpm (whichever is greater)	(awRR × 1.5) or 30 rpm (whichever is smaller)	(awRR+25) or 85 rpm (whichever is smaller)	Adult/pediatric: 6 to 55 Neonate: 10 to 90
	FiAA/ EtAA	Same as the default alarm limit	Same as the default alarm limit	Same as the default alarm limit	Same as the default alarm limit	Same as the measurement range
	FiO ₂ / EtCO ₂	Same as the default alarm limit	Same as the default alarm limit	Same as the default alarm limit	Same as the default alarm limit	Same as the measurement range
	FiN ₂ O/ EtN ₂ O	Same as the default alarm limit	Same as the default alarm limit	Same as the default alarm limit	Same as the default alarm limit	Same as the measurement range
C.O.	BT	Adult: (BT – 1) °C	N/A	Adult: (BT – 1) °C	N/A	Same as the measurement range
RM	RR(RM)	(awRR × 0.5) or 6 rpm (whichever is greater)	N/A	(awRR × 1.5) or 30 rpm (whichever is smaller)	N/A	Adult/pediatric: 6 to 55 Neonate: 10 to 90
	PEEP	(PEEP – 5) cmH ₂ O	N/A	(PEEP + 5) cmH ₂ O	N/A	Same as the measurement range

Module	Parameter	Low alarm limit		High alarm limit		Auto alarm limits range
		Adult/ pediatric	Neonate	Adult/ pediatric	Neonate	
	PIP	(PIP – 10) cmH ₂ O	N/A	(PIP + 10) cmH ₂ O	N/A	Same as the measurement range
	MVe	(MVe – 2) L/min	N/A	(MVe + 2) L/min	N/A	Same as the measurement range
BIS	BIS	N/A				
CCO	CCO/ CCI, EDV/ EDVI, SVR/ SVRI, SV/SVI, RVEF	N/A				
SvO ₂	SvO ₂	(SvO ₂ – 5)%	N/A	(SvO ₂ + 5)%	N/A	Same as the measurement range
	ScvO ₂	(ScvO ₂ – 5)%	N/A	(ScvO ₂ + 5)%	N/A	Same as the measurement range

7.5.3 Setting Alarm Delay Time

You can set the alarm delay time for alarms of continuously measured parameters. If the alarm condition is resolved within the delay time, the monitor will not sound the alarm.

To set the alarm delay time:

1. Select **[Main Menu]**→**[Maintenance >>]**→**[User Maintenance >>]**. Enter the required password and then select **[Ok]**.
2. Select **[Alarm Setup >>]**→**[Alarm Delay]**.

Alarm delay is not applied to the following physiological alarms:

- Apnea
- ST alarms
- Arrhythmia alarms
- ECG Weak Signal
- Resp Artifact
- SpO₂ Desat
- No Pulse
- Nellcor SpO₂ over alarm limits
- FiO₂ Shortage
- Measurements of noncontinuous parameters over alarm limits
- HR over alarm limits
- Anesthetic Mixture's MAC > 3

You can set **[Apnea Delay]** and **[ST Alarm Delay]** separately.

To set the **[Apnea Delay]**, select **[Main Menu]**→**[Alarm Setup >>]**→**[Others]**.

To set the **[ST Alarm Delay]**:

1. Select **[Main Menu]**→**[Maintenance >>]**→**[User Maintenance >>]**. Enter the required password and then select **[OK]**.
2. Select **[Alarm Setup >>]**→**[Alarm Delay]**.

7.5.4 Setting SpO2 Technical Alarm Delay

You can set the **[Tech. Alarm Delay]** in the **[Others]** tab of the **[Alarm Setup]** menu. The options are **[Off]**, **[5 s]**, **[10 s]** and **[15 s]**. The delay is effective to the following technical alarms: SpO₂ Sensor Off, SpO₂ Too Much Light, SpO₂ Low Signal and SpO₂ Interference.

7.5.5 Setting Recording Length

You can change the length of the recorded waveforms. In the **[Others]** window of the **[Alarm Setup]** menu, select **[Recording Length]** and then select **[8 s]**, **[16 s]** or **[32 s]**:

- **[8 s]**: 4 seconds respectively before and after the alarm or manual event trigger moment.
- **[16 s]**: 8 seconds respectively before and after the alarm or manual event trigger moment.
- **[32 s]**: 16 seconds respectively before and after the alarm or manual event trigger moment.

7.5.6 Entering CPB Mode (Cardiopulmonary Bypass Mode)

When performing CPB, you can put the monitor in CPB mode in order to reduce unnecessary alarms. The CPB mode is activated only if you set the department to **[OR]**. To set the department to **[OR]**:

1. Press the **[Menu]** hardkey on the monitor's front panel to enter **[Main Menu]**.
2. Select **[Maintenance >>]**→**[Manage Configuration >>]**. Enter the required password and then select **[Ok]**.
3. Select **[Change Department >>]**→**[OR]**.

In the CPB mode, all the physiological alarms, technical alarms and prompt alarms are switched off except for BIS, tcGas, and NMT related alarms. In CPB mode, **[CPB Mode]** is displayed in the physiological alarm area with a red background color.

To enter CPB mode:

1. Select the **[CPB Mode]** Quickkey or select **[Enter CPB Mode]** in the **[Others]** window of the **[Alarm Setup]** menu.
2. Then select **[Ok]** in the pop-up dialog box.

7.6 Pausing Alarms

You can temporarily disable alarm indicators by pressing the **[Alarm Pause]** hardkey on the monitor's front panel. When alarms are paused:

- For physiological alarms, no alarm indication is shown. New physiological alarms will not be presented.
- The remaining alarm pause time is displayed in the physiological alarm area.
- For technical alarms, alarm sounds are paused, but alarm lamps and alarm messages remain presented.
- The  alarms pause symbol is displayed in the sound symbol area. If a new technical alarm is triggered in the alarm paused period, the alarm message will be displayed.

If the time interval of the monitor's last shutdown from this start-up is greater than 2 minutes, the monitor enters into the alarm paused status as soon as it is turned on. The alarm pause time is fixed to be 2 minutes.

When the alarm pause time expires, the alarm paused status is automatically cancelled and the alarm tone will sound. You can also cancel the alarm paused status by pressing the **[Alarm Pause]** hardkey.

You can set the alarm pause time to **[1 min]**, **[2 min]**, **[3 min]**, **[5 min]**, **[10 min]**, **[15 min]**, or **[Permanent]**. The default alarm pause time is 2 minutes.

1. Select **[Main Menu]**→**[Maintenance >>]**→**[User Maintenance >>]**→enter the required password.
2. Select **[Alarm Setup >>]**→**[Alarm Pause Time]** and then select the appropriate setting from the pop-up list.

7.7 Switching Off All Alarms

If **[Alarm Pause Time]** is set to **[Permanent]**, the monitor will enter into the alarm off status after the **[Alarm Pause]** hardkey is pressed. During the alarm off status:

- For physiological alarms, no alarm lamps flash and no alarms are sounded.
- For physiological alarms, no numerics or alarm limits flash.
- No physiological alarm messages are shown.
- **[Alarm Off]** is displayed in the physiological alarm area with red background.
- For technical alarms, no alarms are sounded.
- The alarm off symbol  is displayed in the alarm symbol area.

You can cancel the alarm off status by pressing the **[Alarm Pause]** hardkey.

WARNING

- **Pausing or switching off alarms may result in a hazard to the patient.**
-

7.8 Resetting Alarms

By selecting the  QuickKey, you can reset the alarm system to acknowledge the on-going alarms and enable the alarm system to respond to a subsequent alarm condition.

For physiological alarms, except the NIBP-related alarms, when the alarm system is reset:

- The alarm sound is silenced.
- A ✓ appears before the alarm message, indicating that the alarm is acknowledged.
- The icon  appears in the alarm symbol area.
- The parameter numeric and alarm limits still flash.

The indication of alarm lamp for the physiological alarm depends on the alarm light setting.

- When **[Alarm Light on Alarm Reset]** is set to **[On]**, the alarm lamp remains flashing.
- When **[Alarm Light on Alarm Reset]** is set to **[Off]**, the alarm lamp stops flashing.

To set **[Alarm Light on Alarm Reset]**:

1. Select **[Main Menu]**→**[Maintenance >>]**→**[User Maintenance >>]**→enter the required password.
2. Select **[Alarm Setup >>]** to enter the **[Alarm Setup]** menu.
3. Select **[Alarm Light on Alarm Reset]**, and then select **[On]** or **[Off]**.

NOTE

-
- **The default setting for [Alarm Light on Alarm Reset] is [On].**
-

Technical alarms give different alarm indicators when the alarm system is reset:

- For some technical alarms, including the NIBP-related alarms, a ✓ appears before the alarm message and  appears in the alarm symbol area, indicating that the alarm is acknowledged. The indication of the alarm lamp depends on the alarm light setting.
- Some technical alarms are changed to the prompt messages.
- Some technical alarms are cleared. The monitor gives no alarm indications.

For details about the indications of technical alarms when the alarm system is reset, refer to appendix **D.2 Technical Alarm Messages**.

7.9 Latching Alarms

The latching setting for physiological alarms defines how alarm indicators behave if you do not reset the alarms.

- If you do not “latch” the physiological alarms, their alarm indications disappear when the alarm condition ends.
- If you “latch” physiological alarms, all visual and audible alarm indications remain until you reset the alarms. For latched alarms the time when the alarm is last triggered is displayed beside the alarm message.

You can separately latch the visual indications or simultaneously latch the visual and the audible indications.

- When the visual indications are latched, the visual indications, including alarm lamp, alarm message and its background remains when the alarm condition ends.
- When the audible indications are latched, the monitor issues alarm sounds when the alarm condition ends.

To latch a physiological alarm:

1. Select **[Main Menu]**→**[Maintenance >>]**→**[User Maintenance >>]**→enter the required password.
2. Select **[Alarm Setup >>]**→**[Latching Alarms>>]**.
3. Select how you want to latch the alarms.

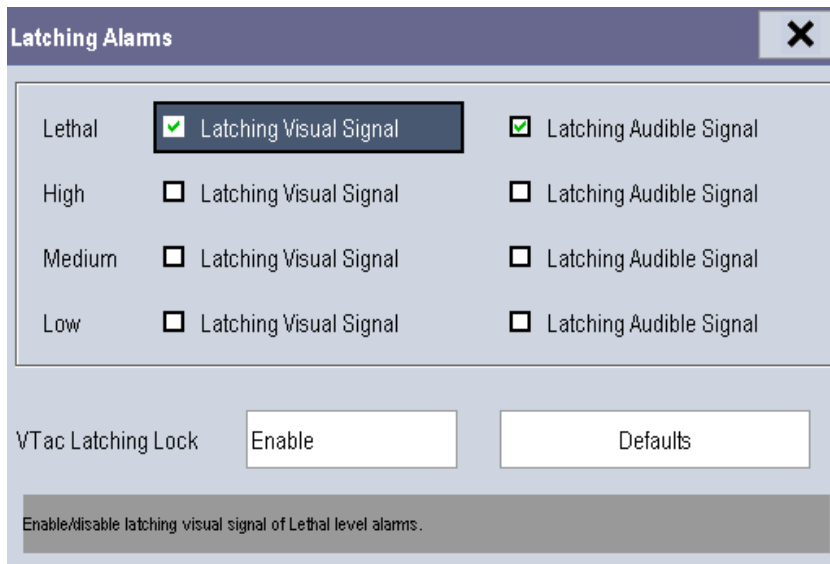

Priority	Latching Visual Signal	Latching Audible Signal
Lethal	<input checked="" type="checkbox"/>	<input checked="" type="checkbox"/>
High	<input type="checkbox"/>	<input type="checkbox"/>
Medium	<input type="checkbox"/>	<input type="checkbox"/>
Low	<input type="checkbox"/>	<input type="checkbox"/>

VTac Latching Lock:

Enable/disable latching visual signal of Lethal level alarms.

The rules for latching the alarms are:

- You can separately select **[Latching Visual Signal]**.
- Selecting **[Latching Audible Signal]** simultaneously latches the visual signal.
- Selecting alarms of lower priority simultaneously latches the alarms of higher priority.
- The lethal alarms are latched by default. High, medium, and low priority alarms are unlatched by default.

NOTE

- **Changing of alarm priority may affect the latching status of corresponding alarms. Please determine if you need to adjust the latching status for the specific alarm when you have changed its alarm priority.**
- **When the alarm system is reset, the latched physiological alarms are cleared.**

You can separately configure the latching of the Vtac alarm. To do so, follow this procedure:

1. Select **[Main Menu]**→**[Maintenance >>]**→**[User Maintenance >>]**→enter the required password.

2. Select **[Alarm Setup >>]**→**[Latching Alarms>>]**.
3. Set **[Vtac Latching Lock]** to **[Disable]**.
4. Select **[Alarm Setup >>]** quickkey to enter **[Alarm Setup]** menu.
5. Select **[Others]** tab.
6. Set **[Vtac Latching]** as desired.

NOTE

- **If the visual signal of lethal alarms is not latched, [Vtac Latching Lock] is not configurable and is automatically set to [Enable].**
-

7.10 Testing Alarms

When the monitor starts up, a self-test is performed. In this case the alarm lamp is lit in yellow and red respectively, and the system gives a beep. This indicates that the visible and audible alarm indicators are functioning correctly.

For further testing of individual measurement alarms, perform the measurement on yourself (for example, SpO₂ or CO₂) or use a simulator. Then adjust alarm limits and check that appropriate alarm behavior is observed.

7.11 Using Care Group Alarms

7.11.1 Care Group Auto Alarms

When a Care Group is set up on your monitor, a flashing symbol will appear beside the QuickKeys area if any monitor in your Care Group, which is not currently viewed by your monitor, is alarming. The alarm symbol is shown as below.



When a monitor in the Care Group is disconnected, the flashing symbol is shown as below.



The department and bed label of the alarming monitor appear on the symbols. You can enter the View Other Patient window by pressing this symbol.

7.11.2 Setting Care Group Alert Tone

When a monitor in the Care Group issues an alarm, your monitor prompts you by sounding an alert tone. To set the alert tone:

1. In the **[Main Menu]**, select **[Screen Setup >>]**→**[Screen Layout >>]**→**[Choose Screen]**.
2. In the **[Choose Screen]** window, select **[View Others Screen]**.
3. In the View Other Patient window, select **[Setup>>]**, and set **[Alert Tone]** to **[Repeat]**, **[Once]** or **[Off]**.

7.11.3 Resetting Care Group Alarms

You can reset the alarm of the currently viewed bed in the View Other Patient window. This function can be set in the **[Alarm Setup]** menu from the **[User Maintenance]** menu only.

To enable this function:

1. Select **[Main Menu]**→**[Maintenance>>]**→**[User Maintenance>>]**→enter the required password→**[Alarm Setup>>]**.
2. In the **[Alarm Setup]** menu, set **[Reset Other Bed's Alarms]** to **[On]**.

When your monitor is viewed by other monitors and **[Alarm Reset By Other Bed]** is switched on, alarms on your monitor can be reset by other monitors.

WARNING

- **Resetting care group alarms may cause a potential hazard.**
-

8 Monitoring ECG

8.1 Introduction

The electrocardiogram (ECG) measures the electrical activity of the heart and displays it on the monitor as a waveform and a numeric. This monitor measures ECG using the MPM module or the T1, or the N1. ECG monitoring provides two algorithms:

- **Advanced ECG algorithm**

The Advanced ECG algorithm enables 3-, 5- and 12-lead ECG monitoring, ST-segment analysis, and extended arrhythmia analysis.

- **Glasgow ECG algorithm**

Glasgow algorithm provides resting 12-lead ECG analysis.

You can select algorithms at the time of purchase or as upgrades post sale:

- The MPM module or T1 incorporating the Advanced ECG algorithm is labeled with an ST/ARR label.
- The N1 incorporating the ST feature is labeled with an ST label.
- The MPM module, the T1, or the N1 incorporating the Glasgow algorithm is labeled with the Glasgow logo.

8.2 Safety

WARNING

- **Use only ECG electrodes and cables specified by the manufacturer.**
 - **Make sure the conductive parts of electrodes and associated connectors for applied parts, including the neutral electrode, should not contact any other conductive parts including earth.**
 - **Periodically inspect the electrode application site to ensure skin quality. If the skin quality changes, replace the electrodes or change the application site.**
 - **Use defibrillation-proof ECG cables during defibrillation.**
 - **Do not touch the patient, or table, or instruments during defibrillation.**
 - **The neutral electrode of the HF surgical unit shall properly contact the patient. Otherwise, burns may result.**
 - **To reduce the hazard of burns during high-frequency surgical procedure, ensure that the monitor's cables and transducers never come into contact with the electrosurgery unit (ESU).**
 - **The equipment is not intended for direct cardiac application.**
-

CAUTION

- **Interference from a non-grounded instrument near the patient and electrosurgery interference can cause problems with the waveform.**
-

NOTE

- **After defibrillation, the screen display recovers within 10 seconds if the correct electrodes are used and applied in accordance with the manufacturer's instructions for use.**
-

8.3 Preparing to Monitor ECG

8.3.1 Preparing the Patient and Placing the Electrodes

To prepare the patient and place the electrodes:

1. Prepare the patient's skin. Proper skin preparation is necessary for good signal quality at the electrode site, as the skin is a poor conductor of electricity. To properly prepare the skin, choose flat areas and then:
 - ◆ Shave hair from skin at chosen sites.
 - ◆ Gently rub skin surface at sites to remove dead skin cells.
 - ◆ Thoroughly cleanse the site with a mild soap and water solution. We do not recommend using ether or pure alcohol, because this dries the skin and increases the resistance.
 - ◆ Dry the skin completely before applying the electrodes.
2. Attach the clips or snaps to the electrodes before placing them.
3. Place the electrodes on the patient.
4. Attach the electrode cable to the patient cable and then plug the patient cable into the ECG connector on the MPM, the T1, or the N1.

8.3.2 Choosing AHA or IEC Lead Placement

To choose AHA or IEC lead placement:

1. Select the ECG parameter window or waveform area to enter the **[ECG Setup]** menu.
2. Select **[Others]**→**[Lead Set]** and then select **[3-lead]**, **[5-lead]**, **[12-lead]** or **[Auto]** according to the applied electrodes.
3. Select **[Main Menu]**→**[Maintenance >>]**→**[User Maintenance >>]**→enter the required password.
4. Select **[Others >>]**→**[ECG Standard]** and then select **[AHA]** or **[IEC]** according to the hospital standard.

8.3.3 ECG Lead Placements

The electrode placement illustrations in this chapter adopt the AHA standard.

3-Leadwire Electrode Placement

Following is an electrode configuration when using 3 leadwires:

- RA placement: directly below the clavicle and near the right shoulder.
- LA placement: directly below the clavicle and near the left shoulder.
- LL placement: on the left lower abdomen.

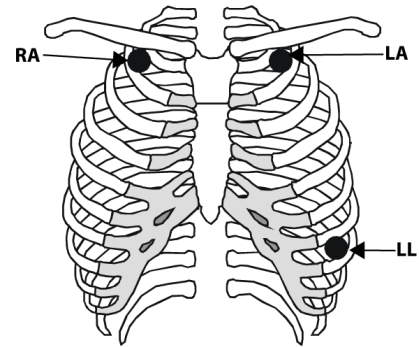

5-Leadwire Electrode Placement

Following is an electrode configuration when using 5 leadwires:

- RA placement: directly below the clavicle and near the right shoulder.
- LA placement: directly below the clavicle and near the left shoulder.
- RL placement: on the right lower abdomen.
- LL placement: on the left lower abdomen.
- V placement: on the chest.

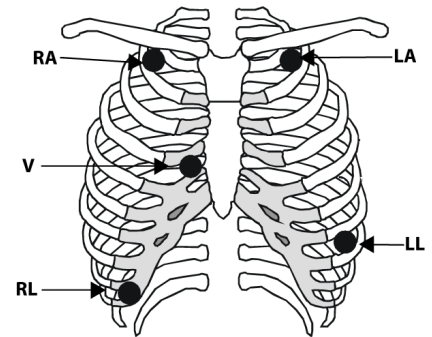

The chest (V) electrode can be placed on one of the following positions:

- V1 placement: on the fourth intercostal space at the right sternal border.
- V2 placement: on the fourth intercostal space at the left sternal border.
- V3 placement: midway between the V2 and V4 electrode positions.
- V4 placement: on the fifth intercostal space at the left midclavicular line.
- V5 placement: on the left anterior axillary line, horizontal with the V4 electrode position.
- V6 placement: on the left midaxillary line, horizontal with the V4 electrode position.
- V3R-V6R placement: on the right side of the chest in positions corresponding to those on the left.
- VE placement: over the xiphoid process.
- V7 placement: on posterior chest at the left posterior axillary line in the fifth intercostal space.
- V7R placement: on posterior chest at the right posterior axillary line in the fifth intercostal space.

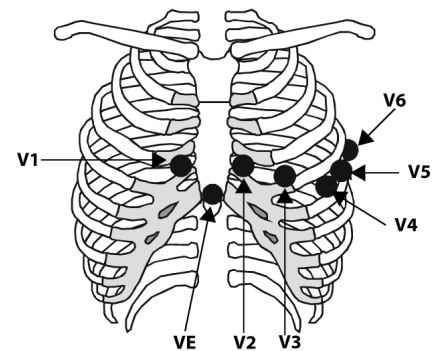

12-Leadwire Electrode Placement

12-lead ECG uses 10 electrodes, which are placed on the patient's four limbs and chest. The limb electrodes should be placed on the soft skin and the chest electrodes placed according to the physician's preference.

Lead Placement for Surgical Patients

The surgical site should be taken into consideration when placing electrodes on a surgical patient. e.g. for open-chest surgery, the chest electrodes can be placed on the lateral chest or back. To reduce artifact and interference from electrosurgical units, you can place the limb electrodes close to the shoulders and lower abdomen and the chest electrodes on the left side of the mid-chest. Do not place the electrodes on the upper arm. Otherwise, the ECG waveform will be very small.

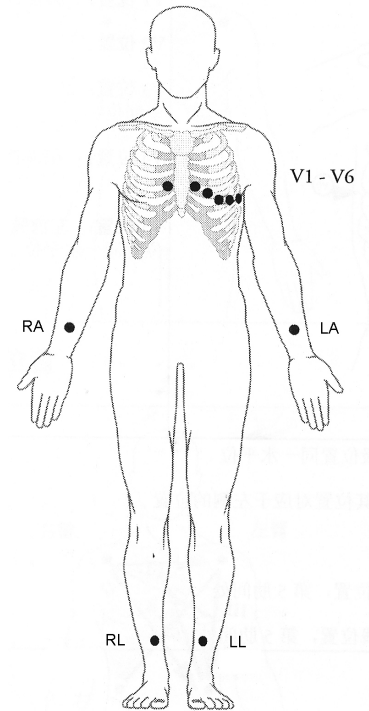

WARNING

- **When using electrosurgical units (ESU), patient leads should be placed in a position that is equal distance from the electrosurgery electrotome and the grounding plate to avoid burns to the patient. Never entangle the ESU cable and the ECG cable together.**
 - **When using electrosurgical units (ESU), never place ECG electrodes near to the grounding plate of the ESU, as this can cause a lot of interference on the ECG signal.**
-

8.3.4 Checking Paced Status

It is important to set the paced status correctly when you start monitoring ECG. The paced symbol  is displayed in the ECG waveform area when the **[Paced]** status is set to **[Yes]**. The pace pulse markers “|” are shown on the ECG wave when the patient has a paced signal. If **[Paced]** is set to **[No]** or the patient's paced status is not selected, the symbol

 will be shown in the ECG waveform area.

To change the paced status, you can select either:

- the patient information area, or
- **[Main Menu]**→**[Patient Setup]**→**[Patient Demographics]**, or,
- the ECG parameter window or waveform area→**[Others >>]**,

and then, select **[Paced]** from the pop-up menu and then select **[Yes]** or **[No]**.

If you do not set the paced status, the monitor issues a prompt tone when pace pulse is detected. At the same time, the paced symbol flashes and the message **[Please confirm the pace of patient]** appears in the ECG waveform area. Then, please check and set the paced status of the patient.

WARNING

- For paced patients, you must set [Paced] to [Yes]. If it is incorrectly set to [No], the monitor could mistake a pace pulse for a QRS and fail to alarm when the ECG signal is too weak.
 - On ventricular paced patients, episodes of Ventricular Tachycardia may not always be detected.
 - False low heart rate indicators or false Asystole calls may result with certain pacemakers because of pacemaker artifact such as electrical overshoot of the pacemaker overlapping the true QRS complexes.
 - Do not rely entirely upon the system's automated arrhythmia detection algorithm. Keep pacemaker patients under close surveillance.
 - For non-paced patients, you must set [Paced] to [No].
 - The auto pacer recognition function is not applicable to pediatric and neonatal patients.
-
-

8.4 Understanding the ECG Display

Your display may be configured to look slightly different.

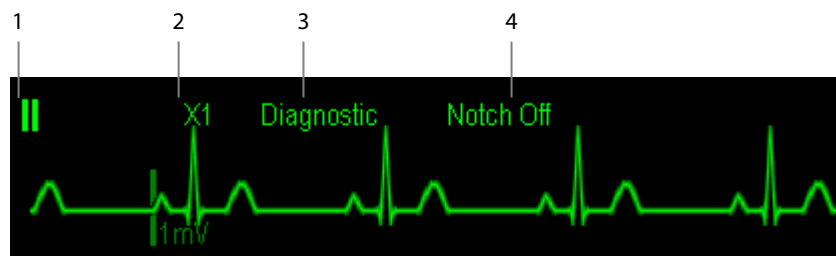

1. Lead label of the displayed wave
2. ECG gain
3. ECG filter label
4. Notch filter status

Additionally, when a paced signal has been detected, the pace pulse marks “|” are shown on the ECG wave if the [Paced] setting has been configured to [Yes].



1. Current heart rate alarm limits
2. Current heart rate
3. Heart beat symbol

8.5 Changing ECG Settings

8.5.1 Accessing ECG Menus

By selecting the ECG parameter window or waveform area, you can access the **[ECG Setup]** menu.

8.5.2 Choosing the Alarm Source

In most cases the HR and PR numerics are identical. In order to avoid simultaneous alarms on HR and PR, the monitor uses either HR or PR as its active alarm source. To change the alarm source, select **[Alm Source]** in the **[ECG Setup]** menu and then select either:

- **[HR]**: if you want the HR to be the alarm source for HR/PR.
- **[PR]**: if you want the PR to be the alarm source for HR/PR.
- **[Auto]**: If the **[Alm Source]** is set to **[Auto]**, the monitor will use the heart rate from the ECG measurements as the alarm source whenever a valid heart rate is available. If the heart rate becomes unavailable, for example the ECG module is turned off or becomes disconnected, the monitor will automatically switch to PR as the alarm source.

8.5.3 Changing ECG Wave Settings

In the **[ECG Setup]** menu:

- You can select **[ECG]**, **[ECG1]**, or **[ECG2]** to select a lead to view. The ECG lead(s) selected is used for analysis (beat detection, arrhythmia classification, and V-Fib detection). The waveform of selected lead should have the following characteristics:
 - ◆ The QRS should be either completely above or below the baseline and it should not be biphasic.
 - ◆ The QRS should be tall and narrow.
 - ◆ The P-waves and T-waves should be less than 0.2mV.
- If the wave is too small or clipped, you can change its size by selecting an appropriate **[Gain]** setting. If you select **[Auto]** from **[Gain]**, the monitor will automatically adjust the size of the ECG waves. In normal screen, only the selected ECG wave's size is adjusted. In other screens, all ECG waves' size is adjusted simultaneously.
- You can change the wave sweep speed by selecting **[Sweep]** and then selecting the appropriate setting.

NOTE

-
- **Changing the display gain on the monitor does not affect the amplitude of signal that is used by the algorithm for beat detection.**
-

8.5.4 Changing the ECG Filter Settings

The ECG filter setting defines how ECG waves are smoothed. To change the filter setting, select **[Filter]** from **[ECG Setup]** and then select the appropriate setting.

- **[Monitor]**: Use under normal measurement conditions.
- **[Diagnostic]**: Use when diagnostic quality is required. The unfiltered ECG wave is displayed so that changes such as R-wave notching or discrete elevation or depression of the ST segment are visible.
- **[Surgery]**: Use when the signal is distorted by high frequency or low frequency interference. High frequency interference usually results in large amplitude spikes making the ECG signal look irregular. Low frequency interference usually leads to wandering or rough baseline. In the operating room, the surgery filter reduces artifacts and interference from electrosurgical units. Under normal measurement conditions, selecting **[Surgery]** may suppress the QRS complexes too much and then interfere with ECG analysis.
- **[ST]**: Recommended when ST monitoring is used. The unfiltered ECG wave is displayed so that changes such as discrete elevation or depression of the ST segment are visible.

CAUTION

- **The [Diagnostic] filter is recommended when monitoring a patient in an environment with slight interference only.**
-

8.5.5 Setting the ECG Lead Set

You can set the **[Lead Set]** by selecting **[ECG Setup]**→**[Others>>]**. You can set the **[Lead Set]** as **[Auto]** if the auto lead detection function is available.

8.5.6 Choosing an ECG Display Screen

When monitoring with a 5-lead or 12-lead set, you can select the **[Screens]** Quickkey and then in the **[Choose Screen]** window, choose the screen type as:

- **[Normal Screen]**: The ECG waveform area displays 2 ECG waveforms.
- **[ECG 7-Lead Full-Screen]**: The whole waveform area displays 7 ECG waveforms only.
- **[ECG 7-Lead Half-Screen]**: The upper half part of the whole waveform area displays 7 ECG waveforms.
- **[ECG 12-Lead Full-Screen]**: The whole waveform area displays 12 ECG waveforms (for 12-lead set only).

When monitoring with a 3-lead set, the screen type can only be set to **[Normal]**.

When the screen type is set to **[Normal Screen]** and **[Sweep Mode]** is set to **[Refresh]**, cascaded ECG waveforms can be displayed.

To cascade ECG waveforms:

1. Select the **[Screens]** Quickkey→**[Screen Setup]**.
2. Select **[ECG1 Casc.]** in the second row. A cascaded waveform is displayed in two waveform positions.

8.5.7 Setting the Notch Filter

The notch filter removes the line frequency interference. Only when **[Filter]** is set to **[Diagnostic]**, the **[Notch Filter]** is adjustable.

To set the notch filter:

1. Select the ECG parameter window or waveform area to enter its setup menu. Then select **[Others >>]**.
2. Set **[Notch Filter]** to:
 - ◆ **[Strong]**: when waveform interference is strong (such as spikes).
 - ◆ **[Weak]**: when waveform interference is weak.
 - ◆ **[Off]**: to turn the notch filter off.

Set notch frequency according to the electric power frequency of your country. To set notch filter frequency:

1. When **[Notch Filter]** is turned on, select **[Main Menu]**→**[Maintenance >>]**→**[User Maintenance >>]**→enter the required password.
2. Select **[Others >>]**→**[Notch Freq.]** and then select **[50 Hz]** or **[60 Hz]** according to the power line frequency.

8.5.8 Changing the Pacer Reject Settings

To change the pacer reject settings, select **[ECG Setup]**→**[Others>>]**→**[Pacer Reject]**, and then select **[On]** or **[Off]**.

- When **[Paced]** is set to **[Yes]**:
 - ◆ When **[Pacer Reject]** is switched on, the pace pulses are not counted as extra QRS complexes.
 - ◆ The pace pulse marks "I" are shown on the ECG wave when pace pulses are detected.
- When **[Paced]** is set to **[No]**, the pace markers are not shown on the ECG wave, and the options of **[Pacer Reject]** are inactivated.

8.5.9 Enabling Smart Lead Off

When the smart lead off function is enabled and there is a "lead off" in the lead of the first ECG wave, if another lead is available, the monitor will automatically select the available lead. The system will re-calculate HR and analyze and detect arrhythmia. When the "lead off" condition is corrected, the leads are automatically switched back.

To switch on/off the smart lead off function, select **[Others >>]** from the **[ECG Setup]** menu; select **[Smart Lead Off]** and then select **[On]** or **[Off]** from the pop-up menu.

8.5.10 Setting the Alarm Level for ECG Lead Off Alarms

Select **[Alarm Setup >>]** from the **[User Maintenance]** menu. You can set **[ECGLeadOff Lev.]** from the pop-up menu.

8.5.11 Adjusting QRS Volume

QRS sounds are produced based on the alarm source.

To adjust the QRS volume:

1. Select **[Others >>]** from the **[ECG Setup]** menu.
2. Select **[QRS Volume]** from the pop-up menu and select the appropriate setting.

When a valid SpO₂ measured value is available, the system adjusts the pitch tone of QRS sound based on the SpO₂ value.

8.5.12 About the Defibrillator Synchronization

A defibrillator synchronization pulse (100 ms, +5V) is output through the Defib. Sync connector every time the monitor detects an R-wave.

To use the defibrillator synchronization function, connect the monitor and the defibrillator with a synchronization cable.

WARNING

- **Improper use of a defibrillator may cause injury to the patient. The user should determine whether to perform defibrillation or not according to the patient's condition.**
-

8.5.13 Adjusting the Minimum QRS Detection Threshold (For Advanced ECG Algorithm Only)

To avoid false asystole alarms when the R wave amplitude is low and missed asystole alarms during ventricular standstill (tall P waves, but no QRS), a means to manually adjust the minimum QRS detection threshold is provided.

To adjust the QRS threshold,

1. In the **[ECG Setup]** menu, set **[Filter]** to **[Monitor]**.
2. Select **[Others >>]**→**[Minimum QRS Threshold >>]** to enter the **[Minimum QRS Threshold]** menu.
3. Select the up or down arrow to adjust the QRS threshold. Selecting **[Default]** resets the QRS threshold to the default value (0.16 mV).
4. Select **[Confirm]** to make the changes effective.

CAUTION

- **The setting of QRS threshold can affect the sensitivity of arrhythmia, ST, QT/QTc detection, and heart rate calculation.**
 - **If QRS amplitude is low, the monitor might not be able to calculate heart rate and false asystole may occur.**
-

NOTE

- The minimum QRS detection threshold can only be adjusted when the ECG filter is set to [Monitor].
-

8.6 About ST Monitoring

- ST segment analysis calculates ST segment elevations and depressions for individual leads and then displays them as numerics in the ST1 and ST2 areas.
- A positive value indicates ST segment elevation; a negative value indicates ST segment depression.
- Measurement unit of the ST segment deviation can be set to mV or mm. You can set the unit in the [Unit Setup] menu from the [User Maintenance] menu.
- Measurement range of the ST segment deviation: -2.0 mV to +2.0 mV (-20.0 mm to +20.0 mm).

NOTE

- The monitor gives the message “Cannot Analyze ST” when the monitor cannot generate a valid ST value. In this case, check the ECG signal quality and ST measurement points. If the message persists, check the patient condition as per section 8.6.1 *Switching ST Monitoring On and Off* and decide whether to continue ST monitoring.
 - The ST algorithm has been tested for accuracy of the ST segment data. The significance of the ST segment changes need to be determined by a clinician.
-

8.6.1 Switching ST Monitoring On and Off

To switch ST monitoring on or off:

1. In the [ECG Setup] menu, select [ST Analysis >>].
2. Next to the **ST Analysis** setting, select [On] or [Off].

Reliable ST monitoring cannot be ensured if:

- You are unable to get a lead that is not noisy.
- Arrhythmias such as atrial fib/flutter cause irregular baseline.
- The patient is continuously ventricularly paced.
- The patient has left bundle branch block.

In these cases, you may consider switching ST monitoring off.

8.6.2 Understanding the ST Display

8.6.2.1 ST Numerics

This example shows ST numerics with 5-lead ECG. Your monitor screen may look slightly different from the illustration. You can also change the ST numerics display.



To change the ST numerics display:

1. Enter the **[ST Analysis]** menu. Set **ST Analysis** to **[On]**.
2. Set **[Display Leads]** to:
 - ◆ **[All]**: ST numerics of all ECG leads are displayed.
 - ◆ **[Selected]**: ST numerics of ECG1 and ECG2 leads set in the **[ECG Setup]** menu are displayed.

8.6.2.2 ST Segment

ST segment shows a QRS complex segment for each measured ST lead. The current ST segment is drawn in the same color as the ECG wave, usually green, superimposed over the stored reference segment, drawn in a different color. The information is updated once every ten seconds.

To display the ST segment on the normal screen:

1. Enter the **[ST Analysis]** menu. Set **ST Analysis** to **[On]**.
2. Enter the **[Screen Setup]** window from the **[Screens]** menu. Set **[ST Segment]** to be displayed.

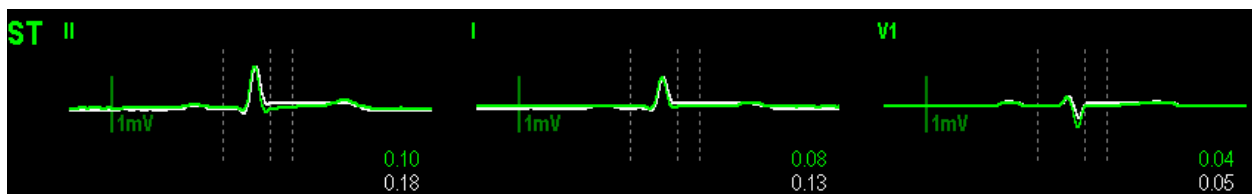

Select the ST parameter window or ST segment area to enter the [ST Analysis] menu.

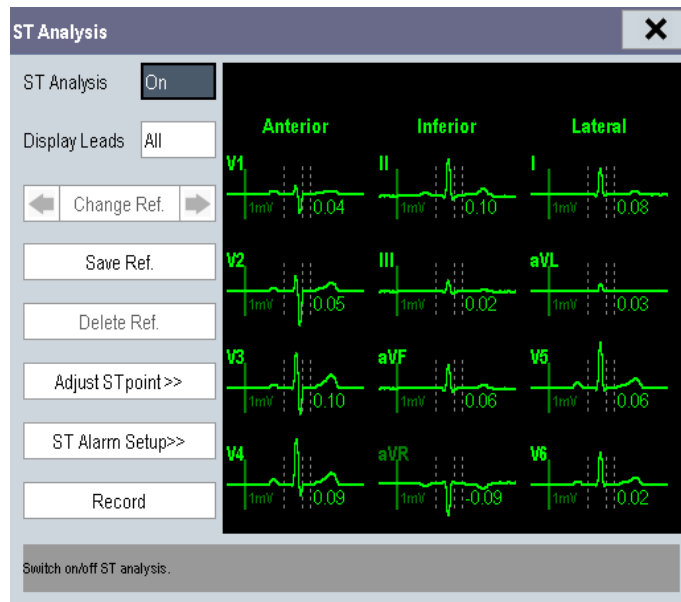

8.6.3 Saving the Current ST Segment as Reference

Select [Save Ref.] in the [ST Analysis] menu to save the current segment as a reference. Up to 20 reference segment groups can be saved.

NOTE

- If the memory is full and you do not delete a group before saving a new one, the earliest saved group is deleted automatically.

8.6.4 Changing the Reference Segment

Select the ◀ and ▶ arrow keys beside the [Change Ref.] to switch between different reference segment groups.

8.6.5 Deleting a Reference Segment

Select [Delete Ref.] in the [ST Analysis] menu and then select [Ok] in the pop-up to delete the current ST reference segment.

8.6.6 Recording the ST Segment

Select [Record] in the [ST Analysis] menu to record the current ST segment and reference segment.

8.6.7 Changing the ST Alarm Limits

High and low ST alarm limits can be set individually for each ECG lead. Alarm limits can also be set separately for single-lead and multi-lead ST monitoring. You can select **[ST Alarm Setup >>]** from **[ST Analysis]** menu and then change ST alarm settings for each lead.

8.6.8 Setting the ST Alarm Delay Time

To set the ST alarm delay time:

1. Select **[Main Menu]**→**[Maintenance >>]**→**[User Maintenance >>]**. Enter the required password and then select **[OK]**.
2. Select **[Alarm Setup >>]**→**[ST Alarm Delay]**.

8.6.9 Adjusting ST Measurement Points

As shown in the figure below, the ST measured for each beat complex is the vertical difference between two measurement points with the R-wave peak as the baseline for the measurement.

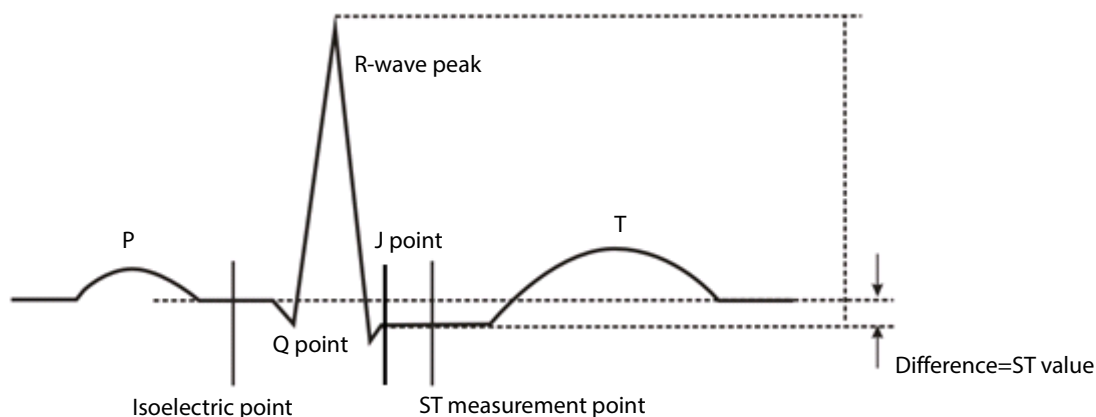

The ISO and ST points need to be adjusted when you start monitoring and if the patient's heart rate or ECG morphology changes significantly. Exceptional QRS complexes are not considered for ST-segment analysis.

WARNING

- **Always ensure that the ST measurement points are appropriate for your patient.**
-

To adjust the ST measurement points:

1. Select the ECG numeric area or waveform area to enter the **[ECG Setup]** menu.
2. Select **[ST Analysis >>]**.
3. Set **ST Analysis** to **[On]**.
4. Select **[Adjust ST Point >>]**.

In the **[Adjust ST Point]** window, three vertical lines represent the ISO, J and ST point positions respectively. In this window, you can:

- Select **[Auto]** to automatically detect the ISO point and J point, and set ST point. When **[Auto]** is selected, the monitor takes a few seconds to finish automatic detection. During this time, the message **[Please wait...]** is displayed in the **[Adjust ST Point]** window.
- Or manually adjust the ISO point, J point, and ST point.

To manually adjust the ST measurement points, follow this procedure:

1. Use the left and right arrows beside **[ISO]** and **[J]** to adjust the position of ISO point and J point.
 - ◆ The ISO-point (isoelectric) position is given relative to the R-wave peak. Position the ISO-point in the middle of the flattest part of the baseline (between the P and Q waves).
 - ◆ The J-point position is given relative to the R-wave peak and helps locating the ST-point. Position the J-point at the end of the QRS complex and the beginning of the ST segment.
2. Set **[ST Point]**. The ST-point is positioned a fixed distance from the J-point. Move the J-point to position the ST-point at the midpoint of the ST segment. Position the ST-point relative to the J-point at either **[J+60/80ms]**, **[J+40ms]**, **[J+60ms]** or **[J+80ms]**. When **[J+60/80ms]** is selected, the ST-point will be positioned 80 ms (heart rate 120 bpm or less) or 60 ms (heart rate more than 120 bpm) from the J-point.

NOTE

- **Only Advanced ECG algorithm has the function of automatic J point detection.**
- **The ISO point, J point, and ST point displayed in the [Adjust ST Point] window are positioned with reference to the R-wave peak.**

8.7 QT/QTc Interval Monitoring (For Advanced ECG Algorithm Only)

The QT interval is defined as the time between the beginning of the Q-wave and the end of the T-wave. It measures the total duration of the depolarization (QRS duration) and repolarization (ST-T) phases of the ventricles. QT interval monitoring can assist in the detection of long QT syndrome.

The QT interval has an inverse relationship to heart rate. As heart rate increases, the QT interval shortens, while at lower heart rates QT interval gets longer. Several formulas are available to correct QT interval for heart rate. The heart rate corrected QT interval is abbreviated as QTc.

QT/QTc Interval Monitoring is intended for adult, pediatric, and neonate patients.

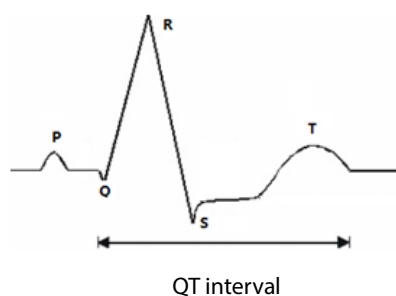

CAUTION

- **For QT interval monitoring to be effective, basic or enhanced arrhythmia monitoring should be turned on.**
-

8.7.1 QT/QTc Monitoring Limitations

Some conditions may make it difficult to achieve reliable QT monitoring, for example:

- R-wave amplitudes are too low
- The presence of frequent ventricular ectopic beats
- Unstable RR intervals
- P-waves tending to encroach on the end of the previous T-wave at high heart rates
- T-waves are very flat or not well defined The end of the T-wave is difficult to delineate because of the presence of U-waves
- QTc measurements are not stable
- In the presence of noise, asystole, ventricular fibrillation, and ECG lead off

For these cases you should select a lead with good T-wave amplitude and no visible flutter activity, and without a predominant U-wave or P-wave.

Some conditions such as left or right bundle branch block or hypertrophy can lead to a widened QRS complex. If a long QTc is observed you should verify it to ensure that it is not caused by QRS widening.

Because normal beats followed by ventricular beats are not included in the analysis, no QT measurement will be generated in the presence of a bigeminy rhythm.

If the heart rate is extremely high (over 150bpm for adults and over 180bpm for pediatrics and neonates), QT will not be measured. When the heart rate changes, it can take several minutes for the QT interval to stabilize. For reliable QTc calculation it is important to avoid the region where the heart rate is changing.

WARNING

- **QT/QTc measurements should always be verified by a qualified clinician**
-

8.7.2 Enabling QT/QTc Monitoring

The QT monitoring function is disabled by default. Before you start QT monitoring, enable the QT function.

To enable QT/QTc monitoring:

1. In the [ECG Setup] menu, select [QT Analysis>>] to enter the [QT Analysis] menu.
2. Set [QT Analysis] to [On].

8.7.3 Displaying QT/QTc Parameters and Waveform

To display QT numerics and waveform:

1. Select the [Screens] QuickKey or select [Main Menu]→[Screen Setup >>]→[Screen Layout >>] to enter the [Screens] window
2. Select the parameter area where you want to display the QT parameters and select [QT].

The following picture shows the QT numeric area. Your monitor screen may look slightly different:

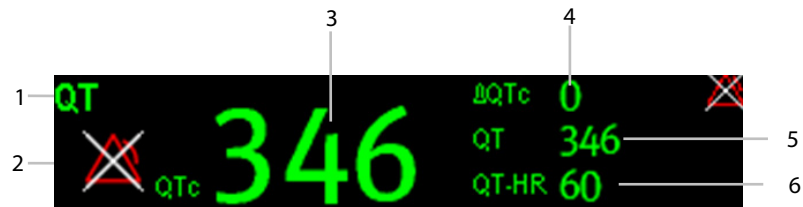

- 1: Parameter label
- 2: QTc alarm limit (if QTc alarm is off, the alarm off symbol is displayed)
- 3: QTc value
- 4: Δ QTc value (the difference between the current and reference QTc values. If Δ QTc alarm is off, the alarm off symbol is displayed on the right.)
- 5: QT value
- 6: QT-HR value

NOTE

- QTc values are calculated based on the QT-HR, not the ECG HR.

8.7.4 Accessing the QT View

QT View shows the current and reference QT parameter values and waveforms.

To access the QT View:

1. Select the QT parameter area or waveform area to enter the [QT Analysis] menu.
2. Select [QT View>>].

The following picture shows the QT view.

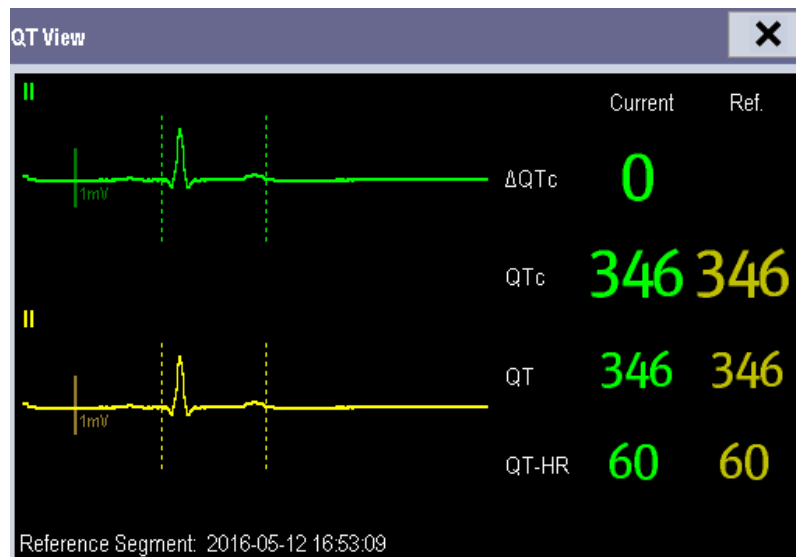

- The current waveform is shown in the upper half in green.
- The reference waveform is shown below in yellow.
- The start of QRS complex and the end of the T wave are marked with vertical lines.
- In some conditions, no QT measurement can be calculated. Then the cause of failed QT measurement is shown at the bottom of the QT numerics area. Additionally the message "Cannot Analyze QT" is shown in the technical alarm area.

In the QT View, you can:

- ◆ Select the arrows besides **[View Leads]** to switch the displayed lead.
- ◆ Select **[Save Ref.]** to save the current QT parameters and waveforms as reference. If no reference has been set for this patient within the first five minutes after getting valid QT values, the monitor will automatically set a reference. If you set a new reference, the previous reference will be discarded.

CAUTION

- **Updating QTc reference affects Δ QTc value and alarm.**
-

8.7.5 Changing QT Settings

8.7.5.1 Setting QT Alarm Properties

To set QT alarm properties,

1. Select the **[Alarm Setup]** QuickKey, or select **[Alarm Setup>>]** from the **[QT Analysis]** menu.
2. Set QTc and Δ QTc alarm properties.

8.7.5.2 Selecting the QT Analysis Lead

You can select one lead or all leads for QT calculation. To select the QT analysis lead:

1. Select the QT parameter area or waveform area to enter the [QT Analysis] menu.
2. Set [Analysis Lead].

When [Analysis Lead] is set to [All]:

- ◆ For 12-lead ECG, leads I, II, III, V2 and V5 are displayed.
- ◆ For 5-lead ECG, leads I, II, III, and V are displayed.

8.7.5.3 Changing QTc Formula

The monitor uses as a default the Hodges correction formula to correct the QT interval for heart rate. To change the QTc formula:

1. Select the QT parameter area or waveform area to enter the [QT Analysis] menu.
2. Set [QTc Formula].

- ◆ Hodges: $QTc = QT + 1.75 \times (HeartRate - 60)$

- ◆ Bazett: $QTc = QT \times \left(\frac{HeartRate}{60} \right)^{\frac{1}{2}}$

- ◆ Fridericia: $QTc = QT \times \left(\frac{HeartRate}{60} \right)^{\frac{1}{3}}$

- ◆ Framingham: $QTc = QT + 154 \times \left(1 - \frac{60}{HeartRate} \right)$

8.8 About Arrhythmia Monitoring

Arrhythmia analysis provides information about the patient's cardiac parameters like heart rate, PVC rate, and rhythm.

WARNING

- **Arrhythmia analysis program is intended to detect ventricular arrhythmias and atrial fibrillation. It is not designed to detect all the atrial or supraventricular arrhythmias. It may incorrectly identify the presence or absence of an arrhythmia. Therefore, a physician must analyze the arrhythmia information with other clinical findings.**
 - **The arrhythmia detection is not intended for neonatal patients.**
 - **Heart-rate reading may be affected by cardiac arrhythmias. Do not rely entirely on rate meter alarms when monitoring patients with arrhythmias. Always keep these patients under close surveillance.**
 - **Atrial fibrillation (Afib) detection function is not intended for pediatric and neonatal patients.**
-

8.8.1 Understanding the Arrhythmia Events

Advanced ECG algorithm

Arrhythmia message	Description	Category
Asystole	No QRS detected within the set time threshold in absence of ventricular fibrillation or chaotic signal.	Lethal arrhythmia
Vfib/Vtac	A fibrillatory wave for 6 consecutive seconds. A dominant rhythm of adjacent Vs and a HR > the V-Tac HR limit.	
Vtac	The consecutive PVCs \geq Vtac PVCs limit, and the HR \geq the Vtac rate limit.	
Vent. Brady	The consecutive PVCs \geq the Vbrd threshold and the ventricular HR < the Vbrd Rate threshold.	
Extreme Tachy	The heart rate is equal to or greater than the extreme tachycardia limit.	
Extreme Brady	The heart rate is equal to or less than the extreme bradycardia limit.	
PVCs	PVCs/min exceeds high limit	Nonlethal arrhythmia
Pacer Not Pacing	No pace pulse detected for 1.75 x average R-to-R intervals following a QRS complex (for paced patients only).	
Pacer Not Capture	No QRS complex detected for 300 milliseconds following a pace pulse (for paced patients only).	
PVC	One PVC detected in normal heartbeats.	
Couplet	Paired PVCs detected in normal heartbeats.	
Run PVCs	More than 2 consecutive PVCs.	
Bigeminy	A dominant rhythm of N, V, N, V, N, V.	
Trigeminy	A dominant rhythm of N, N, V, N, V, N, N, V.	
R on T	R on T detected in normal heartbeats.	
Missed Beats	No beat detected for 1.75 x average R-R interval for HR <120, or No beat for 1 second with HR > 120 (for non-paced patients only), or No beat detected for more than the set pause threshold.	
Brady	The average heart rate is equal to or less than the bradycardia limit.	
Tachy	The average heart rate is equal to or greater than the tachycardia limit.	
Vent. Rhythm	The consecutive PVCs \geq the Vbrd PVCs limit, and HR is \geq Vbrd Rate limit but < the Vtac Rate limit.	
Multif. PVC	Multiform PVCs detected in Multif. PVC's Window (which is adjustable).	
Nonsus. Vtac	The consecutive PVCs < the Vtac PVCs limit but > 2, and HR \geq the Vtac Rate limit.	
Pause	No QRS detected within the set time threshold of pause.	
Irr. Rhythm	Consistently irregular rhythm.	
Afib	Absence of P-waves and/or variable RR intervals between normal beats.	

8.8.2 Changing Arrhythmia Alarm Settings

To change arrhythmia alarm settings, select the ECG parameter area or waveform area → [ECG Setup] → [Arrh. Analysis >>]. In the pop-up menu, you can set the [Alm Lev] to [High], [Med], [Low] or [Message], or switch on lethal arrhythmia analysis alarms only or switch on/off all arrhythmia analysis alarms. In the [Alarm Setup] menu from the [User Maintenance] menu, you can enable/disable turning off lethal arrhythmia analysis alarms.

WARNING

- If you switch off all arrhythmia analysis alarms, the monitor cannot give any arrhythmia analysis alarm. Always keep the patient under close surveillance.
-

NOTE

- The priority of lethal arrhythmia alarms is always high. It is unchangeable.
-

8.8.3 Changing Arrhythmia Threshold Settings

Select the ECG parameter window or waveform area → [Arrh. Analysis >>] → [Arrh. Threshold], and you can then change threshold settings for some arrhythmia alarms. When an arrhythmia violates its threshold, an alarm will be triggered. The asystole delay time relates to ECG relearning. When HR is less than 30 bpm, it is recommended to set the asystole delay time to 10 seconds.

Advanced ECG algorithm

Arrh. event	Range	Default	Step	Unit
PVCs High	1 to 100	10	1	/min
Asys. Delay	3 to 10	5	1	s
Tachy High	60 to 300	Adult: 120 Pediatric: 160	5	bpm
Brady Low	15 to 120	Adult: 50 Pediatric: 75	5	bpm
Extreme Tachy	120 to 300	Adult: 160 Pediatric: 180	5	bpm
Extreme Brady	15 to 60	Adult: 35 Pediatric: 50	5	bpm
Multif. PVC's Window	3 to 31	15	1	/min
Vtac Rate	100 to 200	130	5	bpm
Vtac PVCs	3 to 99	6	1	/min
Pause Time	1.5, 2.0, 2.5	2	/	s
Vbrd PVCs	3 to 99	5	1	/min
Vbrd Rate	15 to 60	40	5	bpm

8.8.4 Setting the Extended Arrhythmia (For Advanced ECG Algorithm Only)

The following arrhythmia events are defined as extended arrhythmia:

- Extreme Tachy
- Extreme Brady
- Vent. Brady
- Nonsus. Vtac
- Multif. PVC
- Irr. Rhythm
- Pause
- Afib

You can select **[Main Menu]**→**[Maintenance >>]**→**[User Maintenance >>]**→enter the required password→select **[Alarm Setup >>]**, and set **[Extended Arrh.]** to **[Enable]** or **[Disable]**. When **[Extended Arrh.]** is set to **[Disable]**, the monitor does not analyze the extended arrhythmia events, and corresponding alarms are not given.

8.8.5 Reviewing Arrhythmia Events

Please refer to chapter **27 Review**.

8.9 ECG Relearning

8.9.1 Initiating an ECG Relearning Manually

During ECG monitoring, you may need to initiate an ECG relearning when the patient's ECG template changes dramatically. A change in the ECG template could result in:

- Incorrect arrhythmia alarms
- Loss of ST measurement, and/or
- Inaccurate heart rate

ECG relearning allows the monitor to learn the new ECG template to correct arrhythmia alarms and HR value, and restore ST measurements. To initiate relearning manually, select the ECG parameter window or waveform area→**[Relearn]**.

When the monitor is learning, the message **[ECG Learning]** is displayed in the technical alarm area.

WARNING

- **Initiate ECG relearning only during periods of normal rhythm and when the ECG signal is relatively noise-free. If ECG learning takes place during ventricular rhythm, the ectopics may be incorrectly learned as the normal QRS complex. This may result in missed detection of subsequent events of V-Tach and V-Fib.**
-

8.9.2 Automatic ECG Relearning

ECG relearning is initiated automatically whenever:

- The ECG lead or lead label is changed.
- The ECG lead is re-connected.
- A new patient is admitted.
- After ECG calibration is completed, and **[Stop Calibrating ECG]** is selected.
- A switch happens between the options of screen type during 5/12-lead ECG monitoring.
- The paced status of the patient is changed.

8.10 12-lead ECG Monitoring

To access the 12-lead ECG monitoring screen:

1. Refer to the section **8.3.3 ECG Lead Placements** to place the electrodes.
2. In the **[ECG Setup]** menu, select **[Others>>]** to enter the **[Other Setup Menu]**.
3. Set **[Lead Set]** to **[12-Lead]**, and set **[ECG Display]** to **[12-Lead]**.

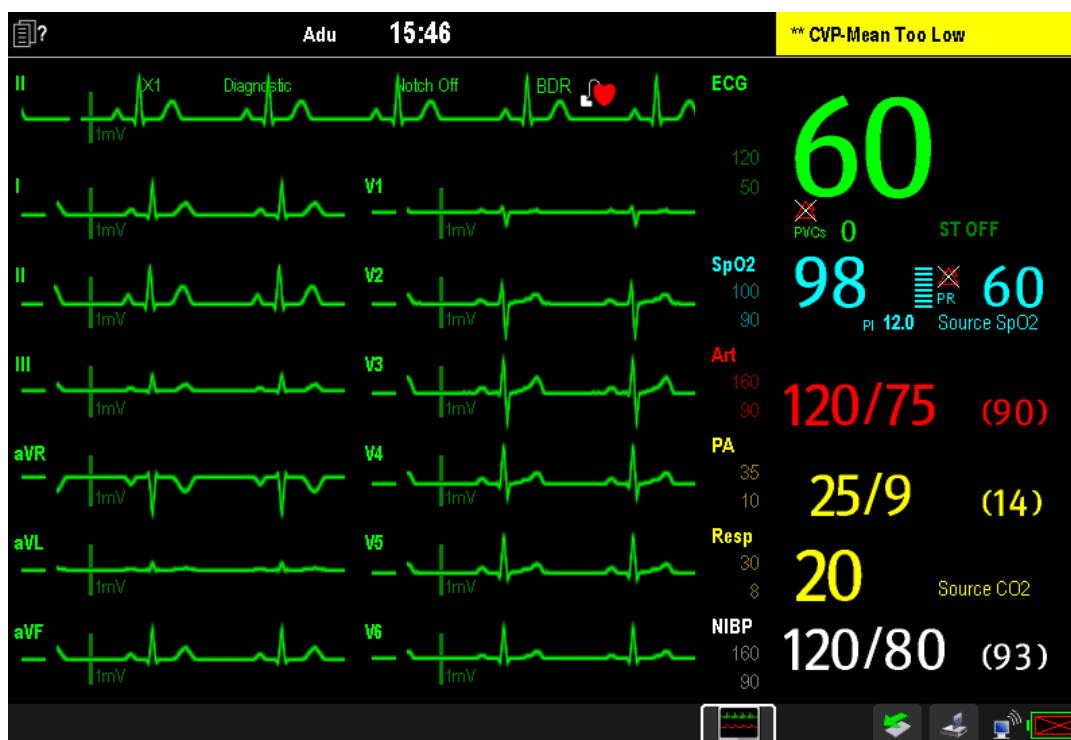

There are a total of 12 ECG waves and 1 rhythm wave displayed on the screen. The rhythm lead is ECG I before entering the 12-lead ECG screen.

The **[Filter]** mode is automatically switched to **[Diagnostic]** when the patient monitor accesses the 12-lead full-screen; the **[Filter]** mode resumes to the configuration before accessing the 12-lead full screen when the patient monitor exits the 12-lead full screen.

8.10.1 Setting ECG Waveform Sequence

You can select the sequence of ECG waveforms on the 12-lead ECG screen and 12-lead ECG report.

To select the sequence of the ECG waveforms:

1. In the **[ECG Setup]** menu, select **[Others>>]** to enter the **[Other Setup Menu]**.
2. Set **[Waveform Layout]** to **[Standard]** or **[Cabrera]**.
 - ◆ **[Standard]**: the sequence is I, II, III, aVR, aVL, aVF, V1, V2, V3, V4, V5, V6.
 - ◆ **[Cabrera]**: the sequence is aVL, I, -aVR, II, aVF, III, V1, V2, V3, V4, V5, V6.

8.10.2 Extending the Rhythm Lead Waveform area

To extend the height of the rhythm lead waveform area:

1. In the **[ECG Setup]** menu, select **[Others>>]** to enter the **[Other Setup Menu]**.
2. Set **[ECG Waveform Area]** to **[Extended]**.

8.11 Resting 12-Lead ECG Analysis

The equipment incorporates the Glasgow algorithm, developed by the University of Glasgow, to provide an interpretation of the resting 12-lead ECG in all situations.

8.11.1 Accessing the 12-Lead Screen

To access the 12-lead screen:

1. In the **[ECG Setup]** menu, select **[Others>>]** to enter the **[Other Setup Menu]**.
2. Set **[Lead Set]** to **[12-Lead]**.
3. Set **[ECG Display]** to **[12-Lead]**.

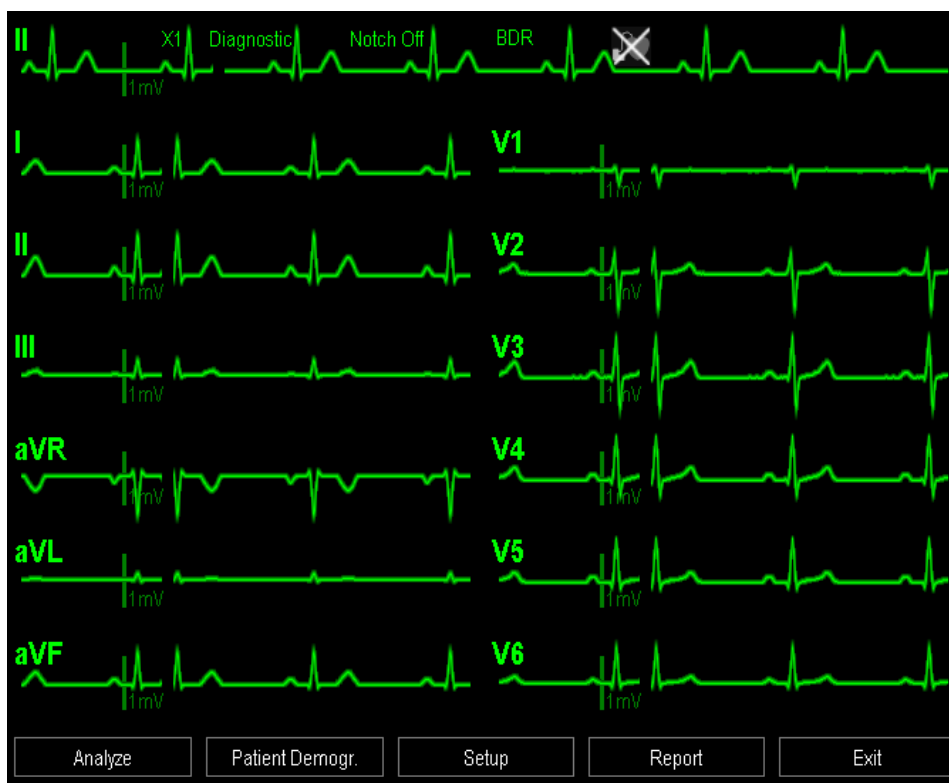

The functions of the keys at the bottom of the 12-lead screen are as follows:

- **[Analyze]**: starts resting 12-lead analysis.
- **[Patient demogr.]**: enters the patient information.
- **[Setup]**: enters the 12-lead setup menu.
- **[Report]**: prints the latest resting 12-lead report.
- **[Exit]**: exits the 12-lead screen.

8.11.2 Entering Patient Information

Some patient information may directly affect ECG analysis. Complete and correct patient information is helpful for accurate diagnosis and treatment of the patient. Enter patient information before taking an ECG measurement.

To enter the patient information, select **[Patient Demogr.]** from the 12-lead screen.

NOTE

- **Check that patient information is correct before resting 12-lead analysis.**
- **We recommend using pediatric lead placement V4R, V1, V2, V4 - V6 if the patient is under 16 years of age. Please record V4R using the V3 electrode. Also set [V3 Electrode Placement] to [V4R]. This is a normal practice for a patient of this age.**

8.11.3 12-Lead Setup

In the 12-lead screen, select [**Setup**] to enter the [**12-Lead Setup**] menu to change the settings related to 12-lead ECG analysis. In the [**12-Lead Setup**] menu, you can also select [**Report Setup>>**] to set the format and contents of the ECG reports.

12-lead Setup			
Menu item	Option	Default	Description
Filter	Diagnostic, ST	Diagnostic	Set filter mode. Note: The filter mode automatically switches to [Diagnostic] when the patient monitor accesses the 12-lead -screen and resumes to the original setting when the patient monitor exits the 12-lead screen.
Baseline Drift Removal	On, Off	On	Select whether the baseline drift removal (BDR) process or 0.05-Hz filter is used. [On]: BDR is enabled. This process suppresses most baseline drift interference and also is able to preserve the fidelity of the ST-segment level. [Off]: BDR is disabled and the 0.05-Hz filter is used. NOTE: BDR or 0.05-Hz selection applies to the displayed ECG, printed report, analyzed and stored data. BDR introduces around 1-second delay. We recommend use of BDR except when the delay is unacceptable. Both BDR and 0.05-Hz selections meet requirements of the 1990 American Heart Association Recommendations for Standardization and Specifications in Automated Electrocardiography: Bandwidth and Signal Processing pertaining to lower-frequency response in electrocardiography.
Tachy High	80 - 130	100	Adjusts tachycardia threshold. Heart rates above the setting are labeled Tachycardia. Only applies to patients whose age exceeds 180 days.
Brady Low	40 - 60	50	Adjusts bradycardia threshold. Heart rates below the setting are labeled Bradycardia. Only applies to patients whose age exceeds 2191 days.
QTc Formula	Hodges, Bazett, Fridericia, Framingham	Hodges	Selects QTc formula. Hodges: $QTc = QT + 1.75 \times (HeartRate - 60)$ Bazett: $QTc = QT \times \left(\frac{HeartRate}{60}\right)^{\frac{1}{2}}$ Fridericia: $QTc = QT \times \left(\frac{HeartRate}{60}\right)^{\frac{1}{3}}$ Framingham: $QTc = QT + 154 \times \left(1 - \frac{60}{HeartRate}\right)$
Waveform Layout	Standard, Cabrera	Standard	Select ECG lead sequence for displaying and printing. [Standard]: the sequence is I, II, III, aVR, aVL, aVF, V1, V2, V3, V4, V5, V6; [Cabrera]: the sequence is aVL, I, -aVR, II, aVF, III, V1, V2, V3, V4, V5, V6.

12-lead Setup			
Menu item	Option	Default	Description
Report setup			
Menu item	Option	Default	Description
Report Format	12×1, 6×2, 3×4+1	3×4+1	Selects the format of the 12-lead ECG report. [12×1]: ECG waveforms are displayed in 12 lines. [6×2]: ECG waveforms are displayed in 6 lines and 2 columns. [3×4+1]: ECG waveforms are displayed in 3 lines and 4 columns followed by the rhythm lead waveform.
Median Complex	On, Off	Off	Selects whether Median Complex is included on the 12-lead ECG report. Median Complex displays a median complex waveform for each lead and a rhythm lead waveform of 10 seconds in 3x4+1 format. For each waveform, short vertical lines are used to mark the start of the P-wave and QRS complex, and the end of the P-wave, QRS complex, and T-wave.
Measurements	On, Off	On	Selects whether the measurement result is included on the 12-lead ECG report. Measurement result includes Vent. Rate, PR Interval, QRS Duration, QT/QTc Interval, and P/QRS/T Axes.
Interpretation	On, Off	On	Selects whether diagnoses are included on the 12-lead ECG report.
Interpretation Summary	On, Off	On	Selects whether interpretation summary is included on the 12-lead ECG report. Note: If the [Interpretation] option is not enabled, interpretation summary is not included on the report even if [Interpretation Summary] is enabled.

8.11.4 Setting the 12-lead Order

To set whether to send the order of 12-lead interpretation report to the hospital information system while saving the report, follow this procedure:

1. elect [Main Menu] → [User Maintenance] → [Others >>].
2. et [12-Lead Order].

8.11.5 Resting 12-lead ECG Analysis

Before 12-lead ECG interpretation, check that all electrodes are correctly connected to the lead wires and the ECG trunk cable is properly connected. Check that patient information is correct.

To start analyzing, select the [Analyze] key. The resting 12-lead analysis takes about 10 seconds. During this period, keep the patient still.

After analysis finishes, the following dialog-box pops up.

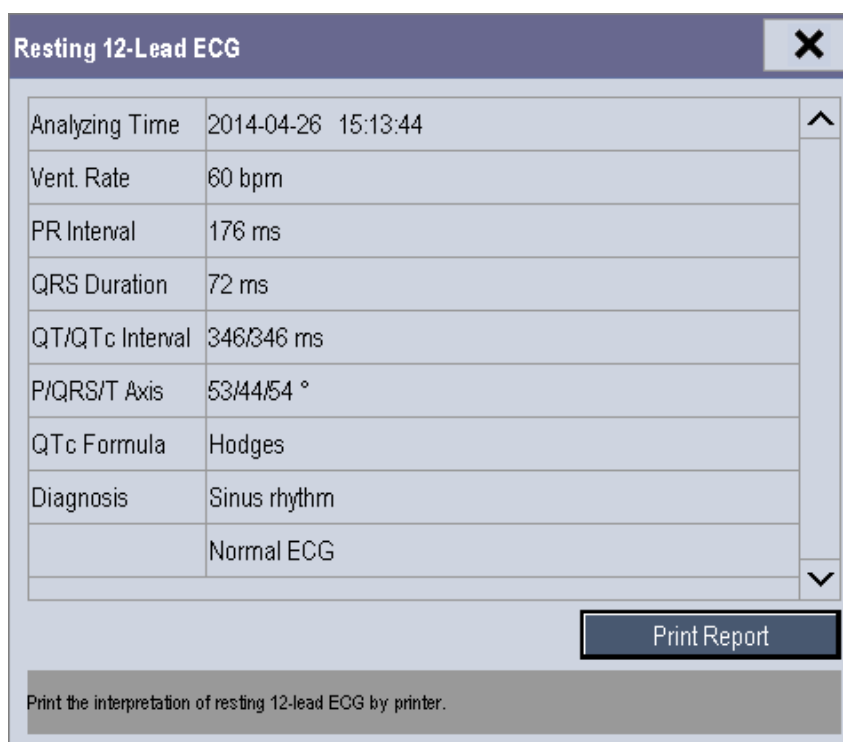

Select [**Print Report**] to print the resting 12-lead ECG report from the external printer.

You can also print the latest 12-lead ECG report by selecting [**Report**] from the 12-lead screen.

Refer to *12-Lead ECG Interpretive Program Physician's Guide* (PN: **046-006360-00**) for details.

CAUTION

- **During the resting 12-lead ECG analysis, keep the patient still. Patient movement may cause misdiagnosis.**
-

NOTE

- **Glasgow resting 12-lead ECG interpretation is applied to adult, pediatric and neonate.**
 - **During 12-lead ECG analysis, 12-lead related settings are disabled.**
 - **Changing patient information, including the patient's age, date of birth, gender, race, medication, class, or V3 placement setting, may change diagnosis statement. You shall select the [Analyze] key to reanalyze the patient's ECG before you print the latest 12-lead ECG report.**
-

8.11.6 12-lead ECG Report

The format and contents of the 12-lead ECG report are configurable. Refer to **Report Setup** in **8.11.3 12-Lead Setup** for details.

The following is a sample of the 12-lead ECG report with default configuration.

	1	2	3	4
MRN:	123456	2014-04-24 10:22:28		
Patient Name:	mike.john	Vent. Rate:	60 bpm	Sinus rhythm
DOB:	1964-01-01	PR Interval:	170 ms	Lead(s) unsuitable for analysis: V4
Age:	50year(s)	QRS Duration:	84 ms	Possible anterior infarct - age undetermined
Gender:	Male	QT/QTc Interval:	366/366 ms	
Race:	Caucasian	P/QRS/T Axis:	54/ 46/ 53 °	Abnormal ECG
Medication:	No Medication	QTc:Hodges		Unconfirmed Diagnosis
Class:	Normal			
Physician:	alex			
Technician:	allen			
Department:	ICU			
Bed No.:	001			

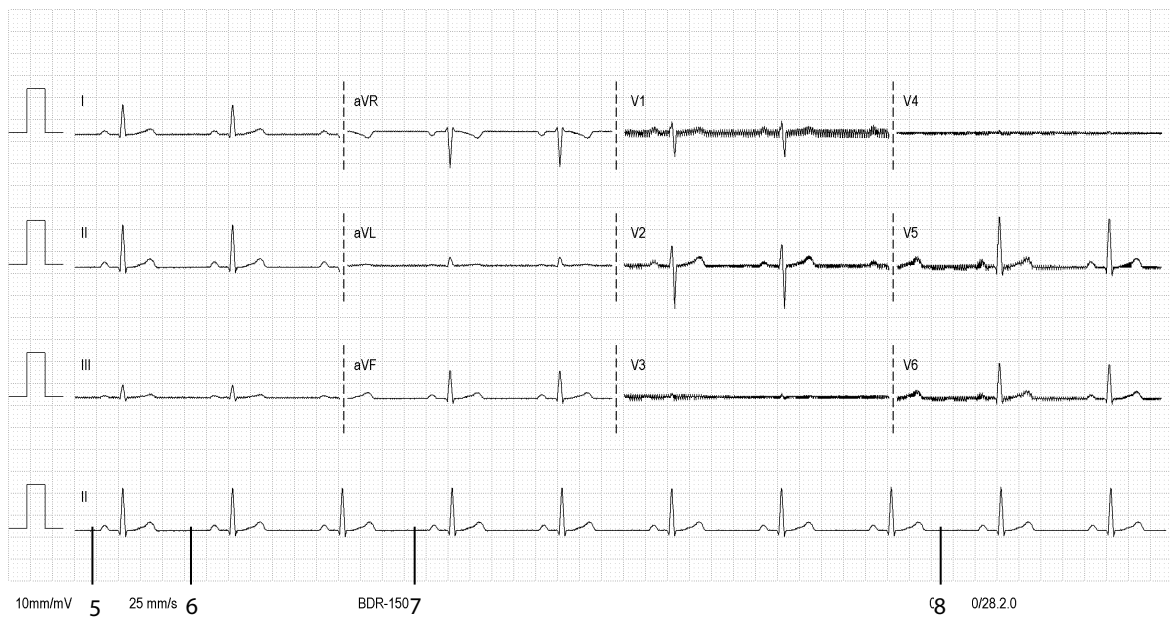

1. Patient information
2. Time of resting 12-lead ECG analysis
3. Measurements
4. Diagnosis statement
5. Waveform amplitude
6. Paper speed
7. Frequency range
8. System software version/algorithm version

8.12 Troubleshooting

This section lists the problems that might occur. If you encounter the problems when using the equipment or accessories, check the table below before requesting services. If the problem persists, contact your service personnel.

CAUTION

- **Never try to disassemble the equipment or supplied accessories. There are no internal user-serviceable parts.**

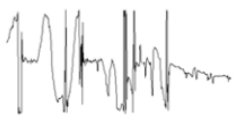
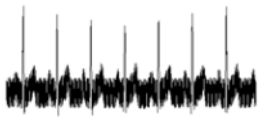
Symptoms	Possible Cause	Correction Action
Noisy ECG traces 	Loose or dry electrodes	Apply fresh and moist electrodes.
	Defective electrode wires	Replace wires if necessary.
	Patient cable or leads are routed too close to other electrical devices	Move the patient cable or leads away from the electrical device.
Excessive Electro-surgical Interference	Wrong ECG cable used	Use ESU-proof ECG cables. For details, refer to section 35.1 ECG Accessories .
Muscle Noise 	Inadequate skin preparation prior to application of electrode, tremors, tense subject, and/or poor electrode placement	Repeat skin preparation as described in section 8.3.1 Preparing the Patient and Placing the Electrodes and re-place the electrodes. Apply fresh, moist electrodes. Avoid muscular areas.
Intermittent Signal	Connections not tight and/or properly secured	Check that the cables are properly connected.
	Electrodes dry or loose	Repeat skin preparation as described in section 8.3.1 Preparing the Patient and Placing the Electrodes and apply fresh and moist electrodes.
	Cable or lead wires damaged	Change cable and lead wires.
Excessive alarms: heart rate, lead fault	Electrodes dry	Repeat skin preparation as described in section 8.3.1 Preparing the Patient and Placing the Electrodes and apply fresh, moist electrodes.
	Excessive patient movement or muscle tremor	Reposition the electrodes. Replace fresh and moist electrodes if necessary.
Low Amplitude ECG Signal	Gain set too low	Set the gain as required. For details, refer to section 8.5.3 Changing ECG Wave Settings .
	Electrodes dry / old	Apply fresh and moist electrodes.
	Skin improperly prepared	Repeat skin preparation as described in section 8.3.1 Preparing the Patient and Placing the Electrodes .
	This could be the patient's normal QRS complex	Verify with another well-functioning monitor.
	Electrode could be positioned over a bone or muscle mass	Move ECG patches away from the bone or muscle mass.

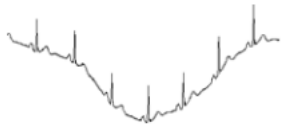
Symptoms	Possible Cause	Correction Action
No ECG Waveform	Gain set too low	Set the gain as required. For details, refer to section 8.5.3 Changing ECG Wave Settings.
	Lead wires and patient cable not fully or properly inserted	Check that the leadwires and patient cables are properly connected.
	Cable or lead wires damaged	Change cable and lead wires.
Base Line Wander 	Patient moving excessively	Secure leadwires and cable to patient.
	Electrodes dry or loose	Repeat skin preparation as described in section 8.3.1 Preparing the Patient and Placing the Electrodes and apply fresh and moist electrodes.
	ECG Filter set to ST or Diagnostic mode	Set ECG Filter to "Monitor" mode.

9 Monitoring Respiration (Resp)

9.1 Introduction

Impedance respiration is measured across the thorax. When the patient is breathing or ventilated, the volume of air changes in the lungs, resulting in impedance changes between the electrodes. Respiration rate (RR) is calculated from these impedance changes, and a respiration waveform appears on the monitor screen.

9.2 Safety Information

WARNING

- When monitoring the patient's respiration, do not use ESU-proof ECG cables.
- If you do not set the detection level for the respiration correctly in manual detection mode, it may not be possible for the monitor to detect apnea. If you set the detection level too low, the monitor is more likely to detect cardiac activity, and to falsely interpret cardiac activity as respiratory activity in the case of apnea.
- The respiration measurement does not recognize the cause of apneas. It only indicates an alarm if no breath is detected when a pre-configured time has elapsed since the last detected breath. Therefore, it cannot be used for diagnostic purpose.
- If operating under conditions according to the EMC Standard EN 60601-1-2 (Radiated Immunity 3V/m), field strengths above 1V/m may cause erroneous measurements at various frequencies. Therefore it is recommended to avoid the use of electrically radiating equipment in close proximity to the respiration measurement unit.

9.3 Understanding the Resp Display

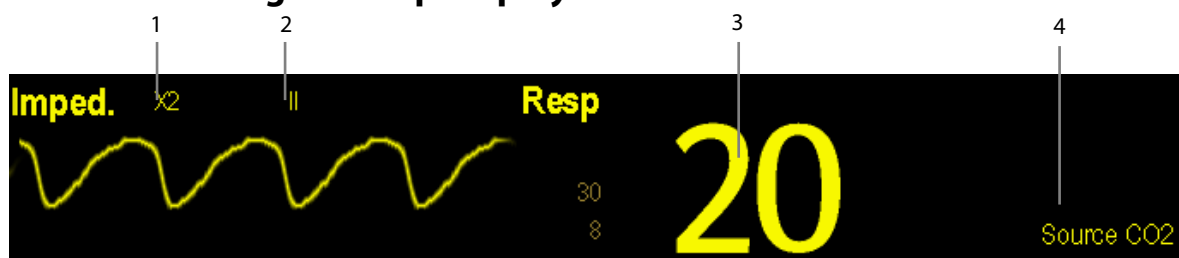

1. Gain
2. Resp lead label
3. Respiration rate
4. RR source

By selecting the waveform area or parameter area, you can enter the **[Resp Setup]** menu.

NOTE

- Respiration monitoring is not for use on the patients who are very active, as this will cause false alarms.

9.4 Placing Resp Electrodes

As the skin is a poor conductor of electricity, preparing the skin is necessary for a good respiration signal. You can refer to the ECG section for how to prepare the skin. For details, refer to section **8.3.1 Preparing the Patient and Placing the Electrodes**.

As the respiration measurement adopts the standard ECG electrode placement, you can use different ECG cables (3-lead, 5-lead or 12-lead). Since the respiration signal is measured between two ECG electrodes, if a standard ECG electrode placement is applied, the two electrodes should be RA and LA of ECG Lead I, or RA and LL of ECG Lead II.

NOTE

- **To optimize the respiration waveform, place the RA and LA electrodes horizontally when monitoring respiration with ECG Lead I; place the RA and LL electrodes diagonally when monitoring respiration with ECG Lead II.**

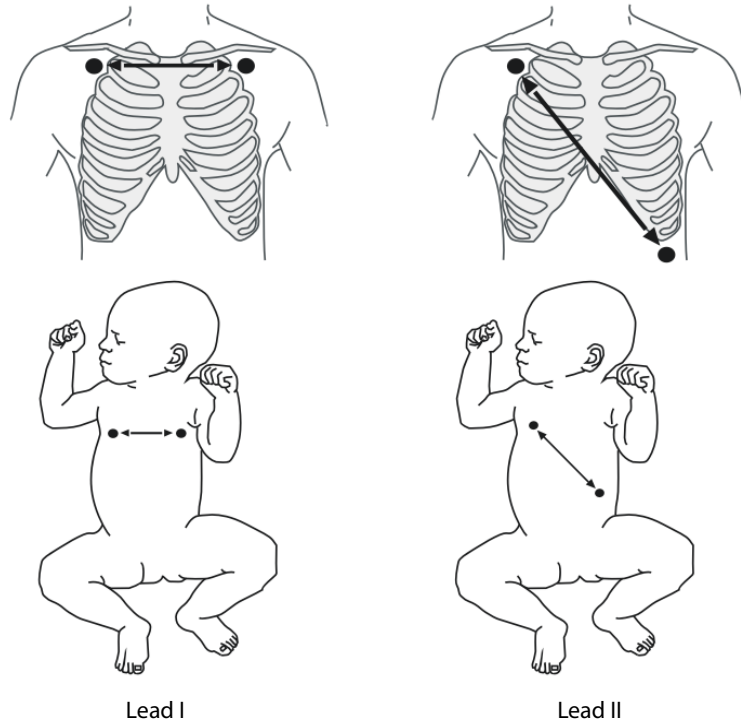

9.4.1 Optimizing Lead Placement for Resp

If you want to measure Resp and you are already measuring ECG, you may need to optimize the placement of the two electrodes between which Resp will be measured. Repositioning ECG electrodes from standard positions results in changes in the ECG waveform and may influence ST and arrhythmia interpretation.

9.4.2 Cardiac Overlay

Cardiac activity that affects the Resp waveform is called cardiac overlay. It happens when the Resp electrodes pick up impedance changes caused by the rhythmic blood flow. Correct electrodes placement can help to reduce cardiac overlay: avoid the liver area and the ventricles of the heart in the line between the respiratory electrodes. This is particularly important for neonates.

9.4.3 Abdominal Breathing

Some patients with restricted movement breathe mainly abdominally. In these cases, you may need to place the left leg electrode on the left abdomen at the point of maximum abdominal expansion to optimise the respiratory wave.

9.4.4 Lateral Chest Expansion

In clinical applications, some patients (especially neonates) expand their chests laterally, causing a negative intrathoracic pressure. In these cases, it is better to place the two respiration electrodes in the right midaxillary and the left lateral chest areas at the patient's maximum point of the breathing movement to optimise the respiratory waveform.

9.5 Choosing the Respiration Lead

In the **[Resp Setup]** menu, set **[Resp Lead]** to **[I]**, **[II]** or **[Auto]**.

9.6 Changing the Apnea Alarm Delay

The apnea alarm is a high-level alarm used to detect apneas. You can set the apnea alarm delay time after which the monitor alarms if the patient stops breathing.

To change the apnea alarm delay:

1. In the **[Resp Setup]** menu, select **[Apnea Delay]**.
2. Select the appropriate setting.

The **[Apnea Delay]** of Resp, CO₂, AG, and RM module keeps consistent with each other.

9.7 Changing Resp Detection Mode

In the [Resp Setup] menu, select [Detection Mode] and then select [Auto] or [Manual].

- In auto detection mode, the monitor adjusts the detection level automatically, depending on the wave height and the presence of cardiac artifact. Note that in auto detection mode, the detection level (a dotted line) is not displayed on the waveform.

Use auto detection mode for situations where:

- ◆ The respiration rate is not close to the heart rate.
- ◆ Breathing is spontaneous, with or without continuous positive airway pressure (CPAP).
- ◆ Patients are ventilated, except patients with intermittent mandatory ventilation (IMV).

- In manual detection mode, you adjust the dotted detection level line to the desired level by selecting [Upper Line] or [Lower Line] and then selecting ▲ or ▼ beside them. Once set, the detection level will not adapt automatically to different respiration depths. It is important to remember that if the depth of breathing changes, you may need to change the detection level.

Use manual detection mode for situations where:

- ◆ The respiration rate and the heart rate are close.
- ◆ Patients have intermittent mandatory ventilation.
- ◆ Respiration is weak. Try repositioning the electrodes to improve the signal.

In Auto Detection Mode, if you are monitoring Resp and ECG is switched off, the monitor cannot compare the ECG and Resp rates to detect cardiac overlay. The respiration detection level is automatically set higher to prevent the detection of cardiac overlay as respiration.

In Manual Detection Mode, cardiac overlay can in certain situations trigger the respiration counter. This may lead to a false indication of a high respiration or an undetected apnea condition. If you suspect that cardiac overlay is being registered as breathing activity, raise the detection level above the zone of cardiac overlay. If the Resp wave is so small that raising the detection level is not possible, you may need to optimize the electrode placement as described in section **9.4.4 Lateral Chest Expansion**.

9.8 Changing Resp Wave Settings

WARNING

- **When monitoring in manual detection mode, make sure to check the respiration detection level after you have increased or decreased the size of the respiration wave.**
-

In the [Resp Setup] menu, you can:

- Select [Gain] and then select an appropriate setting. The bigger the gain is, the larger the wave amplitude is.
- Select [Sweep] and then select an appropriate setting. The faster the wave sweeps, the wider the wave is.

9.9 Setting Respiration Rate (RR) Source

To set RR source:

1. Enter the **[Resp Setup]** menu.
2. Select **[RR Source]** and then select a source or **[Auto]** from the dropdown list.

The dropdown list displays the currently available RR source. When you select **[Auto]**, the system will automatically select the RR source according to the priority. When the current RR source does not have valid measurement, the system will automatically switch the **[RR Source]** to **[Auto]**. RR source switches back to impedance respiration if you press the **[Alarm Reset]** hardkey on the monitor's front panel during an apnea alarm.

The priority of RR source is (from high to low): CO₂ measurement, RM measurement and impedance respiration measurement.

The **[RR Source]** settings of Resp, CO₂, AG and RM module are linked.

The RR source options and description are shown in the table below.

Option	Description
Auto	RR source is automatically selected according to the priority.
CO ₂	RR source is from CO ₂ measurement.
RM	RR source is from RM measurement.
ECG	RR source is from impedance respiration measurement.

9.10 Setting Alarm Properties

Select **[Alarm Setup >>]** from the **[Resp Setup]** menu. In the pop-up menu, you can set alarm properties for this parameter.

FOR YOUR NOTES

10 Monitoring PR

10.1 Introduction

The pulse numeric counts the arterial pulsations that result from the mechanical activity of the heart. You can display a pulse from any measured SpO₂ or any arterial pressure (see chapter **14 Monitoring IBP**). The displayed pulse numeric is color-coded to match its source.



1. PR: detected beats per minute.
2. PR Source

NOTE

- A functional tester or SpO₂ simulator can be used to determine pulse rate accuracy.
-

10.2 Setting the PR Source

The current pulse source is displayed in the PR parameter area. The pulse rate chosen as pulse source:

- is monitored as system pulse and generates alarms when you select PR as the active alarm source;
- is stored in the monitor's database and reviewed in the graphic/tabular trends; in trend graphs, as the PR curve is in the same color with the PR source, it is unlikely to distinguish the PR source;
- is sent via the network to the CMS, if available.

To set which pulse rate as PR source:

1. Enter the **[SpO₂ Setup]** menu.
2. Select **[PR Source]** and then select a label or **[Auto]** from the pop-up menu.

The pop-up menu displays the currently available PR sources from top to bottom by priority. When you select **[Auto]**, the system will automatically select the first option as the PR source from the pop-up menu. When the current PR source is unavailable, the system will automatically switch **[PR Source]** to **[Auto]**. When you select **[IBP]**, the system will automatically select the first pressure label as the PR source from the pop-up menu.

10.3 Selecting the Active Alarm Source

In most cases the HR and pulse numerics are identical. In order to avoid simultaneous alarms on HR and PR, the monitor uses either HR or PR as its active alarm source. To change the alarm source, select **[Alm Source]** in the **[ECG Setup]** or **[SpO2 Setup]** menu and then select either:

- **[HR]**: The monitor will use the HR as the alarm source for HR/pulse.
- **[PR]**: The monitor will use the PR as the alarm source for HR/pulse.
- **[Auto]**: If the **[Alm Source]** is set to **[Auto]**, the monitor will use the heart rate from the ECG measurement as the alarm source whenever the ECG measurement is switched on and a valid heart rate is available. If the heart rate becomes unavailable, for example if leads becomes disconnected, and a pulse source is switch on and available, the monitor will automatically switch to Pulse as the alarm source. When the Leads Off condition is corrected, the monitor will automatically switch back to the heart rate as the alarm source.

10.4 QRS Tone

When PR is used as the alarm source, the PR source will be used as a source for the QRS tone. You can change the QRS volume by adjusting **[Beat Vol]** in the **[SpO2 Setup]** menu. When a valid SpO₂ value exists, the system will adjust the pitch tone of QRS volume according to the SpO₂ value.

11 Monitoring SpO₂

11.1 Introduction

SpO₂ monitoring is a non-invasive technique used to measure the amount of oxygenated haemoglobin and pulse rate by measuring the absorption of selected wavelengths of light. The light generated in the probe passes through the tissue and is converted into electrical signals by the photodetector in the probe. The SpO₂ module processes the electrical signal and displays a waveform and digital values for SpO₂ and pulse rate.

This device is calibrated to display functional oxygen saturation. It provides the following measurements:

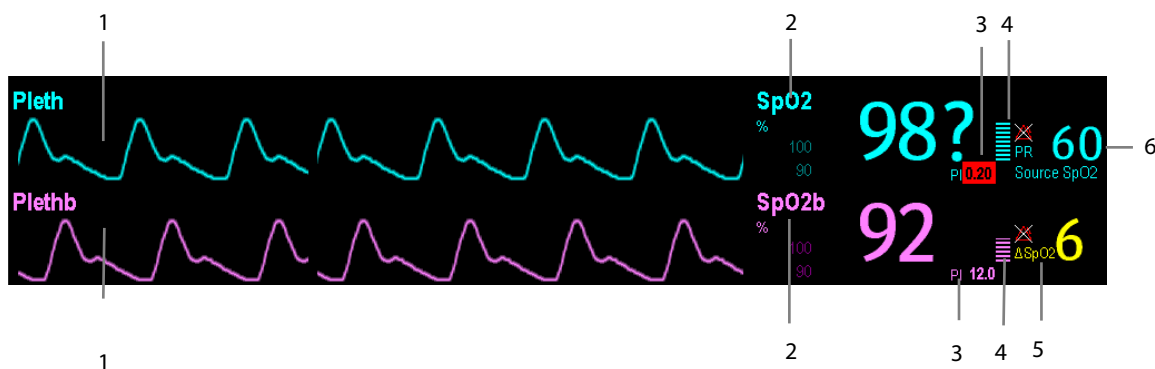

1. Pleth waveform (Pleth/Plethb): visual indication of patient's pulse. The waveform is not normalized.
2. Oxygen saturation of arterial blood (SpO₂/SpO_{2b}): percentage of oxygenated hemoglobin in relation to the sum of oxyhemoglobin and deoxyhemoglobin. SpO₂ measurement is obtained through the MPM module, and SpO_{2b} measurement is obtained through the SpO₂ module.
3. Perfusion index (PI): gives the numerical value for the pulsatile portion of the measured signal caused by arterial pulsation. PI is an indicator of the pulsatile strength. You can also use it to assess the quality of SpO₂ measurement.
 - ◆ Above 1 is optimal.
 - ◆ Between 0.3 and 1 is acceptable.
 - ◆ Below 0.3 indicates low perfusion. When PI is below 0.3, a question mark (?) is displayed to the right of the SpO₂ value, indicating that the SpO₂ value may be inaccurate. Reposition the SpO₂ sensor or find a better site. If low perfusion persists, choose another method to measure oxygen saturation if possible.

PI is available for Masimo SpO₂ module. For Masimo SpO₂ module, PI value can be displayed under the PR value in larger characters if **[PI Zoom]** is enabled.

4. Perfusion indicator: the pulsatile portion of the measured signal caused by arterial pulsation.
5. SpO₂ difference (ΔSpO₂): $\Delta \text{SpO}_2 = | \text{SpO}_2 - \text{SpO}_{2b} |$.
6. Pulse rate (derived from the pleth wave): detected pulsations per minute.

If you need to measure SpO₂ and SpO_{2b}, select the same type of modules. Otherwise, the SpO₂ module for SpO_{2b} is closed automatically. For example, if MPM module configuring Nellcor SpO₂ and Masimo SpO₂ module are applied simultaneously, Masimo SpO₂ module is closed automatically.

NOTE

- **A functional tester or SpO₂ simulator cannot be used to assess the accuracy of a SpO₂ module or a SpO₂ sensor.**
-

11.2 Safety

WARNING

- **Use only SpO₂ sensors specified in this manual. Follow the SpO₂ sensor's instructions for use and adhere to all warnings and cautions.**
 - **When a trend toward patient deoxygenation is indicated, blood samples should be analyzed by a laboratory co-oximeter to completely understand the patient's condition.**
 - **The equipment is not intended for use in an MRI environment.**
 - **Prolonged continuous monitoring may increase the risk of undesirable changes in skin characteristics, such as irritation, reddening, blistering or burns. Inspect the sensor site every two hours and move the sensor if the skin quality changes. Change the application site every four hours. For neonates, or patients with poor peripheral blood circulation or sensitive skin, inspect the sensor site more frequently.**
-

11.3 Identifying SpO₂ Modules

To identify which SpO₂ module is incorporated into your MPM, T1, N1, or SpO₂ module, see the color of the connector and the company logo located at the right upper corner. The color of the cable connector matches the company as shown below:

- Masimo SpO₂ module: a purple connector with a logo of Masimo SET.
- Nellcor SpO₂ module: a grey connector with a logo of Nellcor.

The connectors for these SpO₂ sensors are mutually exclusive.

11.4 Applying the Sensor

To apply the sensor:

1. Select an appropriate sensor according to the module type, patient category and weight.
2. Remove colored nail polish from the application site.
3. Apply the sensor to the patient.
4. Select an appropriate adapter cable according to the connector type and plug this cable into the SpO₂ connector.
5. Connect the sensor cable to the adapter cable.

WARNING

- **If the sensor is too tight because the application site is too large or becomes too large due to edema, excessive pressure for prolonged periods may result in venous congestion distal from the application site, leading to interstitial edema and tissue ischemia.**
-

11.5 Changing SpO₂ Settings

11.5.1 Accessing SpO₂ Menus

By selecting the SpO₂ parameter window or waveform area, you can access the **[SpO₂ Setup]** or **[SpO₂b Setup]** menu.

11.5.2 Adjusting the Desat Alarm

The desat alarm is a high level alarm notifying you of potentially life threatening drops in oxygen saturation. Select **[Alarm Setup >>]** from the **[SpO₂ Setup]** or **[SpO₂b Setup]** menu. From the pop-up menu, you can set low alarm limit, alarm switch, and alarm recording for **[Desat]** or **[Desatb]**. When the SpO₂ value is below the desat alarm limit and desat alarm switch is set on, the message **[SpO₂ Desat]** or **[SpO₂b Desat]** is displayed.

11.5.3 Setting SpO₂ Sensitivity

For Masimo SpO₂ module, you can set **[Sensitivity]** to **[Normal]** or **[Maximum]** in the **[SpO₂ Setup]** or **[SpO₂b Setup]** menu. When the **[Sensitivity]** is set to **[Maximum]**, the monitor is more sensitive to minor signals. When monitoring critically ill patients whose pulsations are very weak, it is strongly recommended that the sensitivity is set to **[Maximum]**. When monitoring neonatal or non-critically ill patients who tend to move a lot, noise or invalid signals may be caused. In this case, it is recommended that the sensitivity is set to **[Normal]** so that the interference caused by motion can be filtered and therefore the measurement stability can be ensured. The settings of sensitivity in the **[SpO₂ Setup]** and **[SpO₂b Setup]** menus are linked.

11.5.4 Changing Averaging Time

The SpO₂ value displayed on the monitor screen is the average of data collected within a specific time. The shorter the averaging time is, the quicker the monitor responds to changes in the patient's oxygen saturation level. Contrarily, the longer the averaging time is, the slower the monitor responds to changes in the patient's oxygen saturation level, but the measurement accuracy will be improved. For critically ill patients, selecting shorter averaging time will help understanding the patient's state.

To set the averaging time for Masimo SpO₂ module:

1. Select **[Averaging]** in the **[SpO₂ Setup]** or **[SpO₂b Setup]** menu.
2. Then select **[2-4 s]**, **[4-6 s]**, **[8 s]**, **[10 s]**, **[12 s]**, **[14 s]** or **[16 s]**.

11.5.5 Monitoring SpO2 and NIBP Simultaneously

When monitoring SpO₂ and NIBP on the same limb simultaneously, you can switch [NIBP Simul] on in the [SpO2 Setup] or [SpO2b Setup] menu to lock the SpO₂ alarm status until the NIBP measurement ends. If you switch [NIBP Simul] off, low perfusion caused by NIBP measurement may lead to inaccurate SpO₂ readings and therefore cause false physiological alarms.

11.5.6 Sat-Seconds Alarm Management

With traditional alarm management, high and low alarm limits are set for monitoring oxygen saturation. During monitoring, as soon as an alarm limit is violated, an audible alarm immediately sounds. When the patient % SpO₂ fluctuates near an alarm limit, the alarm sounds each time the limit is violated. Such frequent alarms can be distracting. Nellcor's Sat-Seconds alarm management technique is used to reduce these nuisance alarms.

The Sat-Seconds feature is available with the Nellcor SpO₂ module to decrease the likelihood of false alarms caused by motion artifacts. To set the Sat-Seconds limit, select [Sat-Seconds] in the [SpO2 Setup] menu and then select the appropriate setting.

With Sat-Seconds alarm management, high and low alarm limits are set in the same way as traditional alarm management. A Sat-Seconds limit is also set. The Sat-Seconds limit controls the amount of time that SpO₂ saturation may be outside the set limits before an alarm sounds. The method of calculation is as follows: the number of percentage points that the SpO₂ saturation falls outside the alarm limit is multiplied by the number of seconds that it remains outside the limit. This can be stated as the equation:

$$\text{Sat-Seconds} = \text{Points} \times \text{Seconds}$$

Only when the Sat-Seconds limit is reached, the monitor gives a Sat-Seconds alarm. For example, the figure below demonstrates the alarm response time with a Sat-Seconds limit set at 50 and a low SpO₂ limit set at 90%. In this example, the patient % SpO₂ drops to 88% (2 points) and remains there for 2 seconds. Then it drops to 86% (4 points) for 3 seconds, and then to 84% (6 points) for 6 seconds. The resulting Sat-Seconds are:

% SpO ₂	Seconds	Sat-Seconds
2×	2=	4
4×	3=	12
6×	6=	36
Total Sat-Seconds=		52

After approximately 10.9 seconds, a Sat-Second alarm would sound, because the limit of 50 Sat-Seconds would have been exceeded.

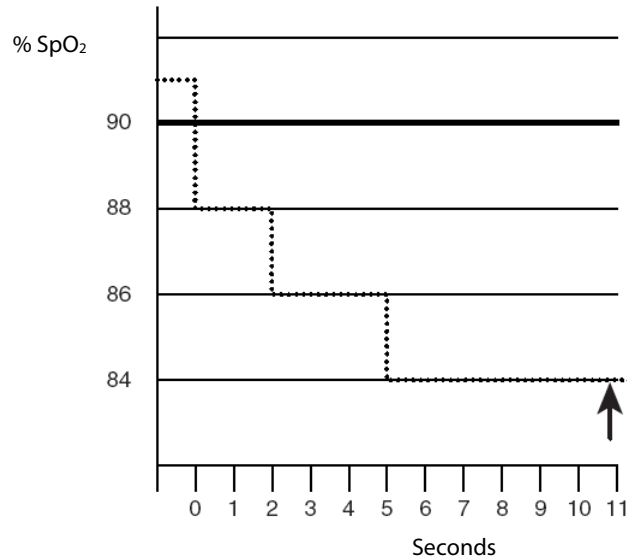

Saturation levels may fluctuate rather than remaining steady for a period of several seconds. Often, the patient % SpO₂ may fluctuate above and below an alarm limit, re-entering the non-alarm range several times. During such fluctuation, the monitor integrates the number of %SpO₂ points, both positive and negative, until either the Sat-Seconds limit is reached, or the patient%SpO₂ re-enters the non-alarm range and remains there.

NOTE

- The “SpO₂ Too Low” or “SpO₂ Too High” alarm is presented in the case that SpO₂ value violates the alarm limits for 3 times within one minute even if the setting of Sat-Seconds is not reached.

11.5.7 Changing the Speed of the Pleth/Plethb Wave

In the [SpO₂ Setup] or [SpO₂b Setup] menu, select [Sweep] and then select the appropriate setting. The faster the waveform sweeps, the wider the waveform is.

11.5.8 Zooming PI Value

For Masimo SpO₂ module, you can display PI value in larger characters for better view. To zoom in the display of PI value, set [PI Zoom] to [Yes] from the [SpO₂ Setup] menu.

11.5.9 Setting the Alarm Level for SpO₂ Sensor Off Alarm

Select [Alarm Setup >>] from the [User Maintenance] menu. You can set the [SpO₂ SensorOff Lev.] in the pop-up menu.

11.5.10 Setting the SpO₂ Tone Mode

Select [**Others >>**] from the [**User Maintenance**] menu. In the pop-up menu, you can set [**SpO₂ Tone**] as [**Mode 1**] or [**Mode 2**].

WARNING

- **The same SpO₂ tone mode shall be used for the same monitors in a single area.**
-
-

11.6 Measurement Limitations

If you doubt the SpO₂ measurement, check the patient's vital signs first. Then check the patient monitor and SpO₂ sensor. The following factors may influence the accuracy of measurement:

- Ambient light
- Physical movement (patient and imposed motion)
- Diagnostic testing
- Low perfusion
- Electromagnetic interference, such as MRI environment
- Electrosurgical units
- Dysfunctional haemoglobin, such as carboxyhemoglobin (COHb) and methemoglobin (MetHb)
- Presence of certain dyes, such as methylene and indigo carmine
- Inappropriate positioning of the SpO₂ sensor, or use of incorrect SpO₂ sensor
- Drop of arterial blood flow to immeasurable level caused by shock, anemia, low temperature or vasoconstrictor.

11.7 Masimo Information



- Masimo Patents

This posting serves as notice under 35 U.S.C. § 287(a) for Masimo patents: <http://www.masimo.com/patents.htm>.

- No Implied License

Possession or purchase of this device does not convey any express or implied license to use the device with unauthorized sensors or cables which would, alone, or in combination with this device, fall within the scope of one or more of the patents relating to this device.

11.8 Nellcor Information



- Nellcor Patents

This posting serves as notice under 35 U.S.C. § 287(a) for Covidien patents: <http://www.covidien.com/patents>.

- No Implied License

Possession or purchase of this device does not convey any express or implied license to use the device with unauthorized replacement parts which would, alone, or in combination with this device, fall within the scope of one or more of the patents relating to this device.

11.9 Troubleshooting

This section lists the problems that might occur. If you encounter the problems when using the equipment or accessories, check the table below before requesting for services. If the problem persists, contact your service personnel.

CAUTION

- **Never try to disassemble the equipment or supplied accessories. There are no internal user-serviceable parts.**
-

Symptoms	Possible Cause	Correction Action
Dashes “-” display in place of numerics.	Measurement is invalid.	Check that the sensor is properly applied. Change the application site if necessary.
Do not see SpO ₂ parameter tiles in display.	Parameter not configured to display.	Switch the SpO ₂ monitoring function on as described in section 3.13.1 Switching the Parameters On/Off .
Unable to obtain SpO ₂ reading	Patient has poor perfusion	Switch limbs/notify physician
	Sensor not on patient	Check if the [SPO2 Sensor Off] alarm is reported. If so, reapply the sensor. If not, contact the service personnel.
	Cables loose/not connected	Check connections, switch cable
	Ambient light	Check if the [SpO2 Too Much Light] alarm is reported. If so, move the sensor to a place with lower level of ambient light or cover the sensor to minimize the ambient light.
No SpO ₂ waveform	Waveform not selected to display	Switch the SpO ₂ monitoring function on as described in section 3.13.1 Switching the Parameters On/Off
	Cable or sensor not plugged in	Check that the cable is properly connected and sensor securely applied.
Low amplitude SpO ₂ signal	SpO ₂ sensor on same limb as cuff	Check that the sensor is properly applied. Change the application site if necessary.
	Patient has poor perfusion	Change the application site.

12 Monitoring NIBP

12.1 Introduction

The MPM, T1, and N1 use the oscillometric method for measuring the non-invasive blood pressure (NIBP). This measurement can be used for adults, pediatrics and neonates.

Automatic non-invasive blood pressure monitoring uses the oscillometric method of measurement. To understand how this method works, we'll compare it to the auscultative method. With auscultation, the clinician listens to the blood pressure and determines the systolic and diastolic pressures. The mean pressure can then be calculated with reference to these pressures as long as the arterial pressure curve is normal.

Since the monitor cannot hear the blood pressure, it measures cuff pressure oscillation amplitudes. Oscillations are caused by blood pressure pulses against the cuff. The oscillation with the greatest amplitude is the mean pressure. This is the most accurate parameter measured by the oscillometric method. Once the mean pressure is determined, the systolic and diastolic pressures are calculated with reference to the mean.

Simply stated, auscultation measures systolic and diastolic pressures and the mean pressure is calculated. The oscillometric method measures the mean pressure and determines the systolic and diastolic pressures.

As specified by IEC 80601-2-30, NIBP measurement can be performed during electro-surgery and discharge of defibrillator.

NIBP diagnostic significance must be decided by the clinician who performs the measurement.

NOTE

-
- **Blood pressure measurements determined with this device are equivalent to those obtained by a trained observer using the cuff/stethoscope auscultatory method or an intra-arterial blood pressure measurement device, within the limits prescribed by the American National Standard, Manual, electronic, or automated sphygmomanometers.**
-

12.2 Safety

WARNING

- **Be sure to select the correct patient category setting for your patient before measurement. Do not apply the higher adult settings for pediatric or neonatal patients. Otherwise it may present a safety hazard.**
 - **Do not measure NIBP on patients with sickle-cell disease or on the limb where skin damage has occurred or is expected.**
 - **Use clinical judgment to determine whether to perform frequent unattended blood pressure measurements on patients with severe blood clotting disorders because of the risk of hematoma in the limb fitted with the cuff.**
 - **Do not use the NIBP cuff on a limb with an intravenous infusion or arterial catheter in place. This could cause tissue damage around the catheter when the infusion is slowed or blocked during cuff inflation.**
 - **NIBP reading can be affected by the measurement site, the position of the PATIENT, exercise, or the patient's physiologic condition. If you doubt the NIBP measurements, determine the patient's vital signs by alternative means and then verify that the monitor is working correctly.**
 - **Do not apply cuff on the arm on the side of a mastectomy.**
 - **Do not modify or replace connectors of the NIBP air hose except with mindray-approved connectors. Use neonatal and infant cuffs with CM1901 hoses only. Use pediatric/adult cuffs with CM1903 hoses only.**
 - **Never connect intra-arterial or intra-venous lines, or any other incompatible connectors to the NIBP hose. This can cause serious injury or death.**
 - **Avoid placing cuff on patient in a manner that can lead to a hose becoming kinked (hose kinking may cause inaccurate readings).**
-

12.3 Measurement Limitations

Measurements are impossible with heart rate extremes of less than 40bpm or greater than 240bpm, or if the patient is on a heart-lung machine.

The measurement may be inaccurate or impossible:

- If a regular arterial pressure pulse is hard to detect
- With excessive and continuous patient movement such as shivering or convulsions
- With cardiac arrhythmias
- Rapid blood pressure changes
- Severe shock or hypothermia that reduces blood flow to the peripheries
- Obesity, where a thick layer of fat surrounding a limb dampens the oscillations coming from the artery

12.4 Measurement Methods

There are three methods of measuring NIBP:

- Manual: measurement on demand.
- Auto: continually repeated measurements at set intervals.
- STAT: continual rapid series of measurements over a five minute period, then return to the previous mode.

12.5 Setting Up the NIBP Measurement

12.5.1 Preparing the Patient

In normal use, perform NIBP measurement on a patient who is in the following position:

- Comfortably seated
- Legs uncrossed
- Feet flat on the floor
- Back, arm and feet supported
- Middle of the cuff at the level of the right atrium of the heart

NOTE

- **It is recommended that the patient relaxes as much as possible before performing measurement and that the patient does not talk during measurement.**
 - **To avoid unnecessary motion artifact, it is recommended to have the patient sit quietly for several minutes before taking the measurement.**
 - **The operator shall not touch the cuff or tubing during NIBP measurement.**
 - **Other factors that have been shown to result in an overestimation of blood pressure are labored breathing, full bladder, pain etc.**
-

12.5.2 Preparing to Measure NIBP

To prepare for the NIBP measurement:

1. Power on the monitor.
2. Verify that the patient category is correct. If not, select the **[Patient Setup]** QuickKey → **[Patient Demographics]** → **[Patient Cat.]** and set the patient category to **[Adu]**, **[Ped]** or **[Neo]**
3. Plug the air tubing into the NIBP connector on the MPM module or T1, or N1.
4. Select a correct sized cuff and then wrap it directly over the patient's skin as follows:
 - ◆ Determine the patient's limb circumference.
 - ◆ Select an appropriate cuff by referring to the limb circumference marked on the cuff. The width of the cuff should be 40% (50% for neonates) of the limb circumference, or 2/3 of the upper arm's length. The inflatable part of the cuff should be long enough to encircle at least 50% to 80% of the limb.
 - ◆ Apply the cuff to the patient's upper arm or leg and make sure the Φ marking on the cuff matches the artery location. The cuff should fit snugly, but with enough room for two fingers to be placed between the cuff and

the patient's arm (on adults), and loosely on neonates with little or no air present within the cuff. Otherwise, it may cause discoloration, and ischemia of the extremities. Make sure that the cuff edge falls within the marked range. If it does not, use a larger or smaller cuff that will fit better.

5. Connect the cuff to the air tubing. Avoid compression or restriction of pressure tubes. Air must pass unrestricted through the tubing.

WARNING

- **Continuous cuff pressure due to connection tubing kinking may cause blood flow interference and resulting harmful injury to the patient.**
-

NOTE

- **Equipment use is restricted to one patient at a time.**
-

12.5.3 Starting and Stopping Measurements

Select the **[NIBP Measure]** QuickKey and you can start the desired measurement from the pop-up menu. You can select **[Stop All]** QuickKey to stop all NIBP measurements. You can also start and stop measurements by using the **[NIBP]** hardkey on either the monitor's front panel or the MPM module.

12.5.4 Correcting the Measurement if Limb is not at Heart Level

The cuff should be applied to a limb at the same level as the patient's heart. If the limb is not at the heart level, to the displayed value:

- Add 0.75 mmHg (0.10 kPa) for each centimetre higher, or
- Deduct 0.75 mmHg (0.10 kPa) for each centimeter lower.

12.5.5 Enabling NIBP Auto Cycling and Setting the Interval

To enable the NIBP auto cycling and set the interval:

1. Select the NIBP parameter window to enter the **[NIBP Setup]** menu.
2. Select **[Interval]** and then select a desired time interval. Selecting **[Manual]** switches to manual mode.
3. Start a measurement manually. The monitor will then automatically repeat NIBP measurements at the set time interval.

12.5.6 Enabling Measurement on Clock

In auto measurement mode, if the clock is enabled, the monitor automatically synchronizes NIBP automatic measurements with the real time clock. For example, if **[Interval]** is set to **[20 min]**, and you start NIBP auto measurement at 14: 03, the next measurement will be taken at 14: 20, and then at 14:40, 15:00, and so on.

To enable measurement on clock:

1. Select the NIBP parameter window to enter the **[NIBP Setup]** menu.
2. Set **[Clock]** to **[On]**.

NOTE

- **The measurement on clock feature is only available for patient monitors supporting Advanced ECG algorithm.**
- **Measurement on clock is effective only when NIBP Interval is set to [5min] or an option greater than 5 min.**

12.5.7 Starting a STAT Measurement

To start a STAT measurement:

1. Select the NIBP parameter window to enter the **[NIBP Setup]** menu.
2. Select **[NIBP STAT]**. The STAT mode initiates 5 minutes of continuous, sequential, automatic NIBP measurements.

WARNING

- **Continuous non-invasive blood pressure measurements may cause purpura, ischemia and neuropathy in the limb with the cuff. Inspect the application site regularly to ensure skin quality and inspect the cuffed limb for normal color, warmth and sensitivity. If any abnormality occurs, move the cuff to another site or stop the blood pressure measurements immediately.**

12.6 Understanding the NIBP Numerics

The NIBP display shows numerics only as below. Your display may be configured to look slightly different.

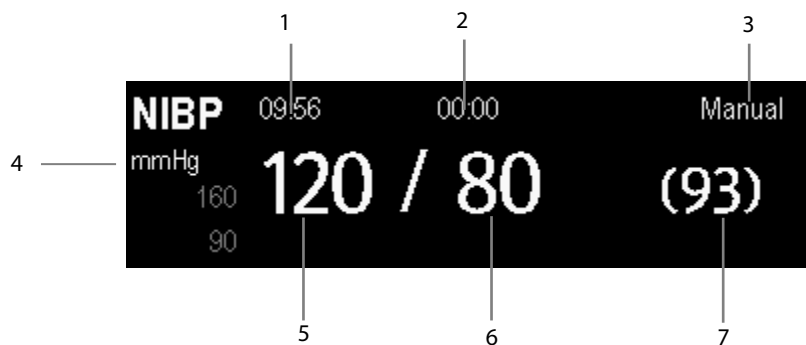

1. Time of last measurement
2. Time remaining to next measurement
3. Measurement mode
4. Unit of pressure: mmHg or kPa
5. Systolic pressure
6. Diastolic pressure
7. Mean pressure obtained after the measurement and cuff pressure obtained during the measurement

If the NIBP measurement exceeds the measurement range, “---” will be displayed.

12.7 Changing NIBP Settings

By selecting the NIBP parameter window, you can enter the **[NIBP Setup]** menu.

12.7.1 Setting the Initial Cuff Inflation Pressure

You can set the initial cuff inflation pressure manually. In the **[NIBP Setup]** menu, select **[Initial Pressure]** and then select the appropriate setting.

NOTE

-
- **For known hypertensive patients, you need to set initial cuff pressure to a higher value to reduce the measurement time.**
-

12.7.2 Setting NIBP Alarm Properties

Select **[Alarm Setup >>]** from the **[NIBP Setup]** menu. You can set the alarm properties for this parameter in the pop-up menu.

12.7.3 Displaying NIBP List

Select **[Screens]** QuickKey→**[Screen Setup]**. You can set **[NIBP List]** to be displayed at the bottom area of the screen, where the most recent NIBP measurements display. Then, multiple sets of most recent NIBP measurements will be displayed. And the displayed PR is derived from NIBP.

NIBP List	PR	Time
120 / 80 (93)	60	17:15
120 / 80 (93)	60	16:23
120 / 80 (93)	60	16:09
120 / 80 (93)	60	14:24

You can not display NIBP list in some screens such as the big numerics screen.

12.7.4 Setting the Pressure Unit

Select **[Unit Setup >>]** from the **[User Maintenance]** menu. In the pop-up menu, select **[Press. Unit]** and then select **[mmHg]** or **[kPa]**.

12.7.5 Switching On NIBP End Tone

The monitor can issue a reminder tone at the completion of NIBP measurement. The NIBP end tone is off by default. You can switch it on by accessing the **[NIBP Setup]** menu.

12.8 Assisting Venous Puncture

You can use the NIBP cuff to cause sub-diastolic pressure to block the venous blood vessel and therefore help venous puncture.

1. Select [**VeniPuncture >>]** from the [**NIBP Setup**] menu. In the pop-up menu, verify that the [**Cuff Press.**] value is appropriate. Change it if necessary.
2. Select [**VeniPuncture**].
3. Puncture vein and draw blood sample.
4. Select the [**NIBP**] hardkey on the monitor's front panel, or the [**Stop All**] QuickKey to deflate the cuff. The cuff deflates automatically after a set time if you do not deflate it.

During measurement, the NIBP display shows the inflation pressure of the cuff and the remaining time in venous puncture mode.

FOR YOUR NOTES

13 Monitoring Temp

13.1 Introduction

The equipment is used to monitor skin temperature and core temperature. You can simultaneously monitor two temperature sites using the MPM, the T1, or the N1.

13.2 Safety

WARNING

- **Verify that the probe detection program works correctly before monitoring. Remove the temperature probe cable from the T1 or T2 connector, and the monitor can display the message [T1 Sensor Off] or [T2 Sensor Off] and give alarm tones correctly.**
-

13.3 Taking a Temp Measurement

To take a Temp measurement:

1. Select an appropriate probe for your patient according to patient type and measuring site.
2. If you are using a disposable probe, connect the probe to the temperature cable.
3. Plug the probe or temperature cable to the temperature connector.
4. Attach the probe to the patient correctly.
5. Check that the alarm settings are appropriate for this patient.

13.4 Understanding the Temp Display

The temperature monitoring is displayed on the monitor as three numerics: T1, T2 and TD. By selecting this area, you can enter the **[Alarm Setup]** menu.



13.5 Setting the Temperature Unit

Select [**Unit Setup >>**] from the [**User Maintenance**] menu. In the pop-up menu, select [**Temp Unit**] and then select [**°C**] or [**°F**].

14 Monitoring IBP

14.1 Introduction

You can measure invasive blood pressure (IBP) using the MPM, T1, N1, or the pressure plug-in module. The Passport 12m and Passport 17m patient monitor can monitor up to 8 invasive blood pressures and displays the systolic, diastolic and mean pressures and a waveform for each pressure.

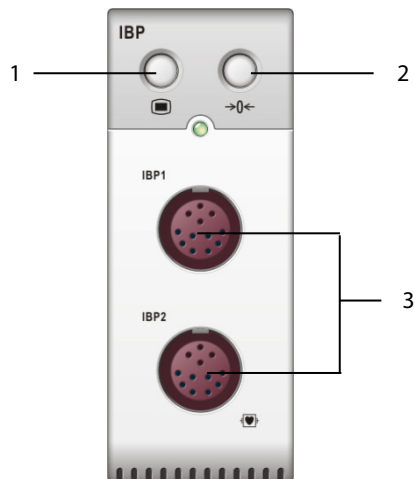

1. Setup key
2. Zero key
3. IBP cable connector

14.2 Safety

WARNING

- **Use only pressure transducers specified in this manual. Never reuse disposable pressure transducers.**
 - **Make sure that the applied parts never contact other conductive parts.**
 - **To reduce the hazard of burns during high-frequency surgical procedure, ensure that the monitor's cables and transducers never come into contact with the high-frequency surgical units.**
 - **When using accessories, their operating temperature should be taken into consideration. For details, refer to instructions for use of accessories.**
 - **The neutral electrode of the electro-surgery unit (ESU) shall properly contact the patient. Otherwise, burns may result.**
-

14.3 Zeroing the Transducer

To avoid inaccurate pressure readings, the monitor requires a valid zero. Zero the transducer in accordance with your hospital policy (at least once per day).

Zero whenever:

- A new transducer or adapter cable is used.
- You reconnect the transducer cable to the monitor.
- The monitor restarts.
- You doubt the readings.

To zero the transducer:

1. Turn off the stopcock to the patient.

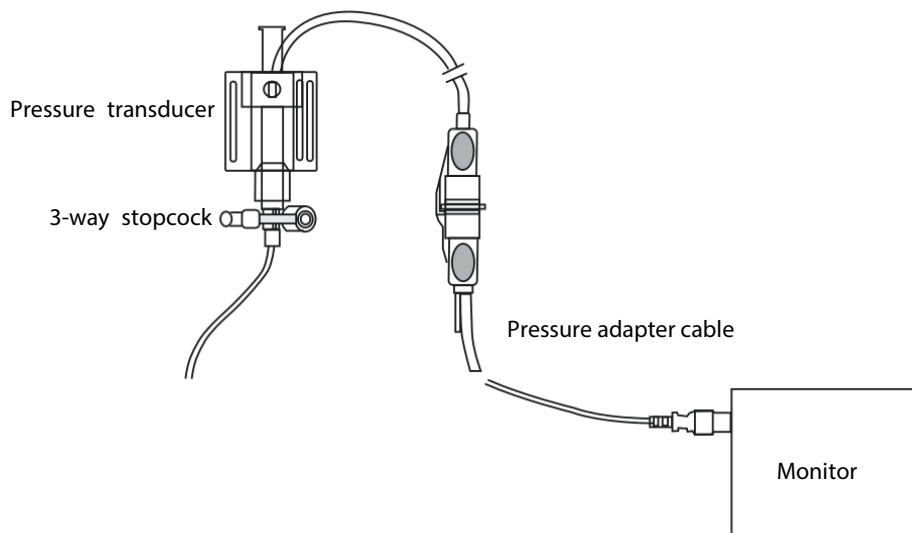

2. Vent the transducer to the atmospheric pressure by turning on the stopcock to the air.
3. Press the $\rightarrow 0 \leftarrow$ hardkey on the module, or, in the setup menu for the pressure (e.g. Art), select [**Art Zero >>**] \rightarrow [**Zero**]. During zero calibration, the [**Zero**] button appears dimmed. It recovers after the zero calibration is completed. To zero all IBP channels, select [**Zero IBP**] hotkey, and then select [**Zero All Channels**] in the pop-up menu.
4. After the zero calibration is completed, close the stopcock to the air and open the stopcock to the patient.

NOTE

-
- **Your hospital policy may recommend that the ICP transducer is zeroed less frequently than other transducers.**
-

14.4 Setting Up the Pressure Measurement

To set up the pressure measurement:

1. Plug the pressure cable into the IBP connector.
2. Prepare the flush solution.
3. Flush the system to exhaust all air from the tubing. Ensure that the transducer and stopcocks are free of air bubbles.

WARNING

- **If air bubbles appear in the tubing system, flush the system with the infusion solution again. Air bubbles may lead to incorrect pressure readings.**
-

4. Connect the pressure line to the patient catheter.
5. Position the transducer so that it is level with the heart, approximately at the level of the midaxillary line.
6. Select the appropriate label.
7. Zero the transducer. After a successful zeroing, turn off the stopcock to the air and turn on the stopcock to the patient.

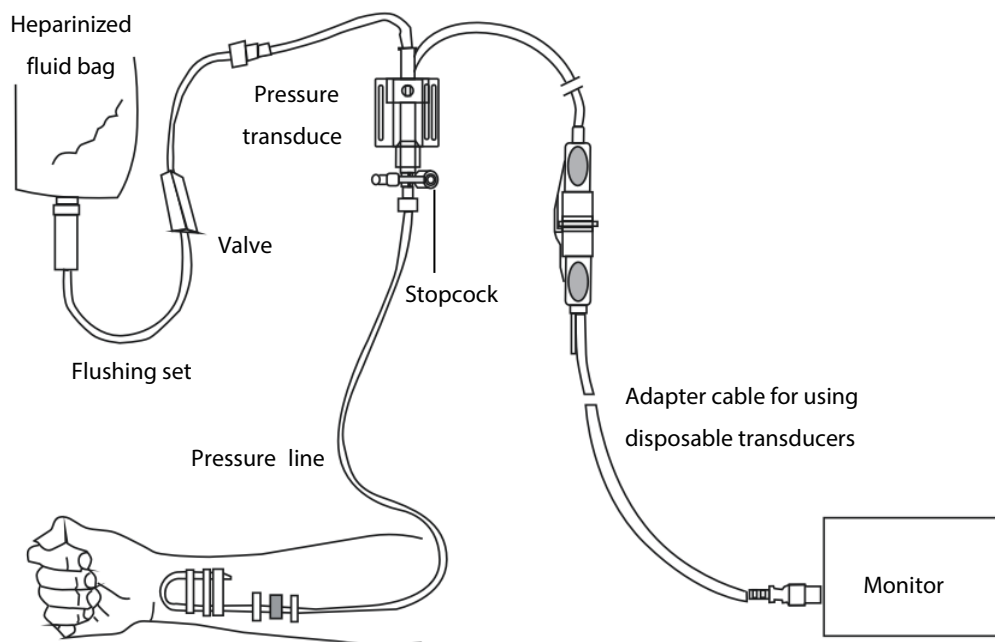

WARNING

- **If measuring intracranial pressure (ICP) with a sitting patient, level the transducer with the top of the patient's ear. Incorrect leveling may give incorrect values.**
-

14.5 Understanding the IBP Display

The IBP measurement is displayed on the monitor as a waveform and numeric pressures. The figure below shows the waveform and numerics for the Art pressure. For different pressures, this display may be slightly different.

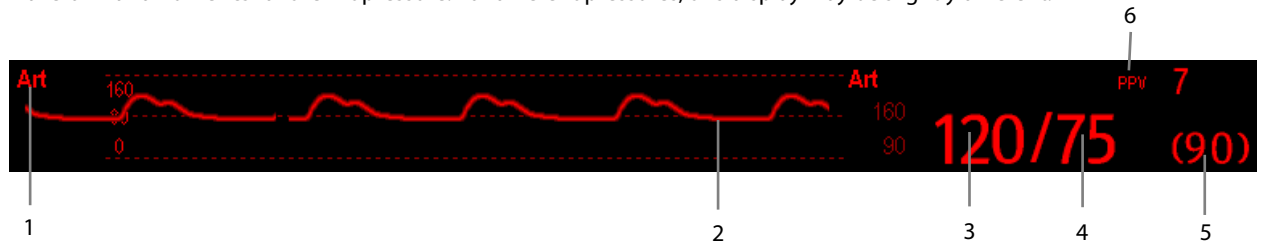

1. Pressure label
2. Waveform
3. Systolic pressure
4. Diastolic pressure
5. Mean pressure
6. PPV measurement

For some pressures, the parameter window may show the mean pressure only. For different pressures, their default unit may be different. If the Art and ICP pressures are measured simultaneously, the ICP parameter area will display numeric CPP, which is obtained by subtracting ICP from the Art mean.

14.6 Changing IBP Settings

14.6.1 Changing a Pressure for Monitoring

To change a pressure for monitoring:

1. Select the pressure you want to change to enter its setup menu. In the menu, there is a figure showing the current IBP measurement connector.

Art Setup

IBP1Label	Art	Art Zero>>
Scale	0 to 160	Alarm Setup >>
Sweep	25 mm/s	
Filter	12.5 Hz	
Sensitivity	High	
PPV Measurement	On	
PPV Source	Auto	

Change the size of the Art waveform by adjusting the scale height.

2. Select **[Label]** and then select your desired label from the list. Labels already used cannot be selected.

Label	Description	Label	Description
PA	Pulmonary artery pressure	CVP	Central venous pressure
Ao	Aortic pressure	LAP	Left atrial pressure
UAP	Umbilical arterial pressure	RAP	Right atrial pressure
BAP	Brachial arterial pressure	ICP	Intracranial pressure
FAP	Femoral arterial pressure	UVP	Umbilical venous pressure
Art	Arterial blood pressure	LV	Left ventricular pressure
P1 to P4	Non-specific pressure label		

NOTE

- **When two pressures are detected having the same label, the monitor automatically changes one pressure label to a currently unused one.**

14.6.2 Setting Alarm Properties

Select **[Alarm Setup >>]** from the parameter setup menu. You can set alarm properties for this parameter in the pop-up menu.

14.6.3 Changing Averaging Time

The IBP value displayed on the monitor screen is the average of data collected within a specific time. The shorter the averaging time is, the quicker the monitor responds to changes in the patient's blood pressure. Contrarily, the longer the averaging time is, the slower the monitor responds to changes in the patient's blood pressure, but the measurement accuracy will be improved. For critically ill patients, selecting shorter averaging time will help understanding the patient's state.

To set the averaging time, in the parameter setup menu, select **[Sensitivity]** and then select **[High]**, **[Med]** or **[Low]**, the corresponding averaging time is about 1 s, 8 s and 12 s respectively.

14.6.4 Setting Up the IBP Wave

In the setup menu for the pressure, you can:

- Select **[Sweep]** and then select the appropriate setting. The faster the wave sweeps, the wider the wave is.
- Select **[Scale]** and then select the appropriate setting. If **[Auto]** is selected, the size of the pressure's waveform will be adjusted automatically.
- Select **[Filter]** and then select the desired option.

14.6.5 Setting the Pressure Unit

Select **[Unit Setup >>]** from the **[User Maintenance]** menu. In the pop-up menu, select **[Press. Unit]** and then select **[mmHg]** or **[kPa]**. Select **[CVP Unit]** and then select **[mmHg]**, **[cmH₂O]** or **[kPa]**.

14.6.6 Enabling PPV Measurement and Setting PPV Source

PPV indicates pulse pressure variation. To enable PPV measurement, set [PPV Measurement] to [On].

You can select PPV source by enabling the PPV measurement.

WARNING

- This monitor can calculate PPV from beat-to-beat values of any arterial pulsatile pressure. The circumstances under which the calculation of a PPV value is clinically meaningful, appropriate and reliable must be determined by a physician.
 - The clinical value of the derived PPV information must be determined by a physician. According to recent scientific literature, the clinical relevance of PPV information is restricted to sedated patients receiving controlled mechanical ventilation and mainly free from cardiac arrhythmia.
 - PPV calculation may lead to inaccurate values in the following situations:
 - ◆ at respiration rates below 8 rpm
 - ◆ during ventilation with tidal volumes lower than 8 ml/kg
 - ◆ for patients with acute right ventricular dysfunction (“cor pulmonale”).
 - The PPV measurement has been validated only for adult patients.
-

14.7 Overlapping IBP Waveforms

The IBP waveforms can be displayed together. To combine IBP waveforms:

1. Select [Main Menu]→[Screen Setup>>]→[Screen Layout>>] to access the [Screens] window.
2. Select the [Screen Setup] tab.
3. In Area A, select [IBP Overlap] from the drop-down list, and then select the IBP waves to be overlapped on the left side of the same line. Refer to section 3.10 *Setting the Screen* for Area A.
4. Select to save the setting and exit the window. The main screen will display the overlapped IBP waves.

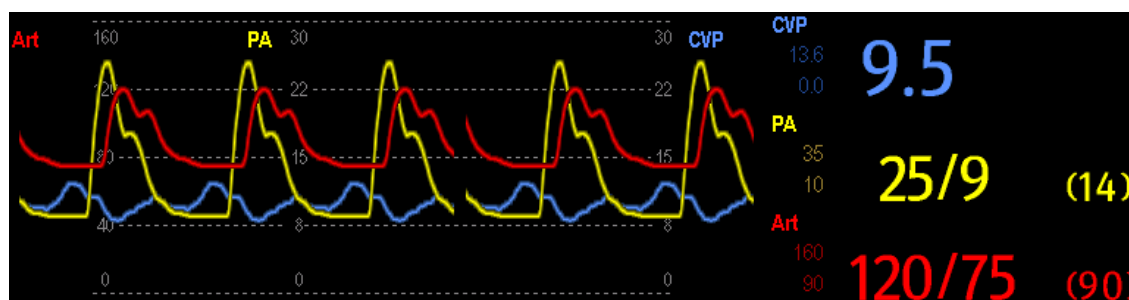

Selecting the overlapped IBP waveforms on the main screen opens the [Overlapping Waveform Setup] menu, where you can:

- Set [Left Scale] and [Right Scale] and then set the scales for the overlapped waveforms. The left scale is for Art, LV, Ao, FAP, BAP, UAP, and the arterial waveforms of P1~P4; the right scale is for CVP, ICP, LAP, RAP, UVP, and the venous waveforms of P1~P4.
- Set [CVP Scale] individually if the CVP waveform is combined and CVP unit is different from IBP unit.

- Set **[PA Scale]** individually if PA waveform is combined.
- Set **[Gridlines]** to **[On]** or **[Off]** to show gridlines or not in the overlapped waveform area.
- Select **[Sweep]** and then set the sweep speed for the overlapped waveforms.
- Select **[Filter]** and then set the filter for the overlapped waveforms.

You can also change above settings from corresponding IBP setup menu.

Note

-
- **The CVP scale changes simultaneously with the right scale. The unit of CVP scale is consistent with CVP parameter unit.**
-

14.8 Measuring PAWP

Pulmonary Artery Wedge Pressure (PAWP) values, used to assess cardiac function, are affected by fluid status, myocardial contractility, and valve and pulmonary circulation integrity.

Obtain the measurement by introducing a balloon-tipped pulmonary artery flotation catheter into the pulmonary artery. When the catheter is in one of the smaller pulmonary arteries, the inflated balloon occludes the artery allowing the monitor to record changes in the intrathoracic pressures that occur throughout the respiration cycle.

The pulmonary wedge pressure is the left ventricular end diastolic pressure when the airway pressure and valve function are normal. The most accurate PAWP values are obtained at the end of the respiration cycle when the intrathoracic pressure is fairly constant and the artifact caused by respiration is minimal.

WARNING

- **PAWP monitoring is not intended for neonatal patients.**
-

14.8.1 Preparing to Measure PAWP

To prepare for a PAWP measurement:

1. Prepare the same accessories as in the C.O. measurement. Connect the parts such as catheter, syringe, etc. following the C.O. measurement steps and use the balloon inflation port. Refer to section **15.4 Setting Up the C.O. Measurement** for more information.
2. Connect the PAWP cable into the IBP connector. Since PAWP is measured on PA, selecting **[PA]** as the IBP label is recommended.
3. Select the PA parameter window or waveform area to enter its setup menu. Then, select **[PAWP]** to enter the PAWP measurement window. You can also enter the PAWP measurement window from the P1-P4 parameter window.

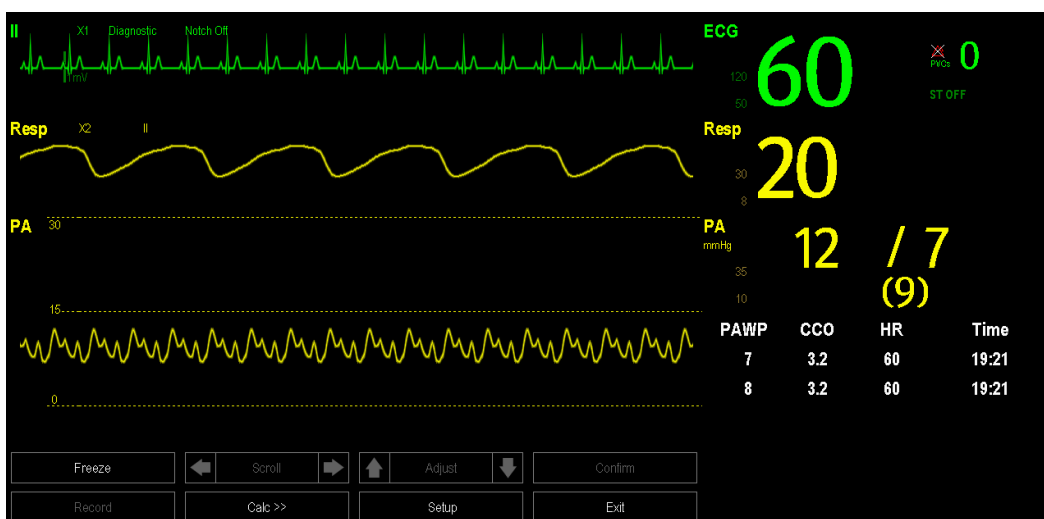

NOTE



- After entering the PAWP measurement window, the monitor will turn off the PA alarm automatically.

14.8.2 Setting Up the PAWP Measurement

To set up the PAWP measurement:

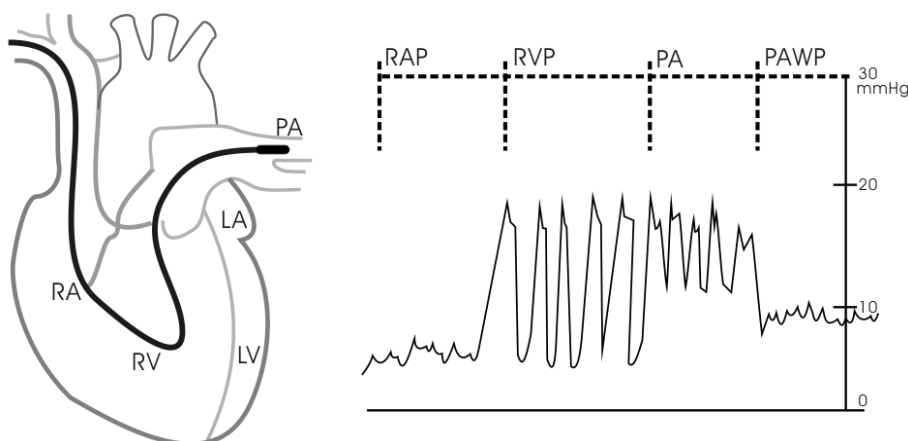
- Wedge the flotation catheter into the pulmonary artery. Then inflate the balloon and pay attention to the PA waveform changes on the screen.



- After obtaining a stable PAWP waveform, press the **[Freeze]** key to freeze the waveform and deflate the balloon.
- You can adjust the PAWP scale to an appropriate position by adjusting  or  beside the **[Adjust]** button. Press the **[Confirm]** key to save one PAWP measurement.
- If you need to start a new measurement, select **[Next Measure]**.

WARNING

- **Prolonged inflation can cause pulmonary hemorrhage, infarction or both. Inflate the balloon for the minimum time necessary to get an accurate measurement.**
 - **If the PAWP is greater than the PA (systolic), deflate the balloon and report the incident in accordance with hospital policy. Because the pulmonary artery could be accidentally ruptured, and the PAWP value derived will not reflect the patient's hemodynamic state, but will merely reflect the pressure in the catheter or balloon.**
-

14.8.3 Understanding the PAWP Setup Menu

Select [**Setup**] to enter the [**PAWP Setup**] menu. In this menu, you can:

- Select an ECG lead wave as the first reference wave.
- Select a respiration wave as the second reference wave.
- Select a sweep speed for the displayed waveform.
- Change the size of the PA waveform by adjusting the scale height.

14.9 Troubleshooting

This section lists the problems that might occur. If you encounter the problems when using the equipment or accessories, check the table below before requesting for services. If the problem persists, contact your service personnel.

CAUTION

- **Never try to disassemble the equipment or supplied accessories. There are no internal user-serviceable parts.**
-

Symptoms	Possible Cause	Correction Action
Damped invasive waveform	Air bubbles in tubing	Eliminate air from tubing as described in section 14.4 Setting Up the Pressure Measurement .
	Kinked catheter	Change the position of catheter.
	Blood in tubing	Pressurize the solution bag to 300 mmHg. For details, refer to the instructions for use of the solution bag.
IBP not displayed/no IBP waveform	Improper setup	Check display setup in monitor setup.
	Cable not plugged in	Check that the cables are properly connected.
	Transducer not connected.	Check that the transducer is properly connected.
	Stopcock turned improperly.	Check that the stopcock is turned to the correct position.
	Transducer not zeroed	Check and zero the transducer as described in section 14.3 Zeroing the Transducer
Dashes “-” display in place of numerics.	The measured result is invalid or out of range. IBP might be set to non-pulsatile labels like CVP, LA, RA, and ICP.	Change to a pulsatile label.
Abnormally high or low readings	Transducer too High or too Low.	Adjust the position of the transducer and make sure that it is level with the heart, approximately at the level of the midaxillary line. Zero the transducer as described in section 14.3 Zeroing the Transducer .
Unable to Zero	Stopcock not open to atmosphere.	Check the transducer and make sure the stopcock is turned to the air.
PAWP button disabled	One IBP channel must be labeled PA	Label an IBP channel as PA. (Also Label an IBP channel as P1/P2/P3/P4, it will automatically change to PA)

15 Monitoring Cardiac Output

15.1 Introduction

The cardiac output (C.O.) measurement invasively measures cardiac output and other hemodynamic parameters using the right heart (atria) thermodilution method. A cold solution of known volume and temperature is injected into the right atrium through the proximal port of a pulmonary artery (PA) catheter. The cold solution mixes with the blood in the right ventricle and the change in blood temperature is measured with a thermistor at the distal end of the catheter in the pulmonary artery. The temperature change is displayed as a curve in the C.O. split screen, and the monitor calculates the C.O. value from this curve. The C.O. value is inversely proportional to the area under the curve. As cardiac output varies continuously, a series of measurements must be carried out to achieve a reliable C.O. average value. Always use the average of multiple thermodilution measurements for therapy decisions. The monitor is capable of storing 6 measurements.

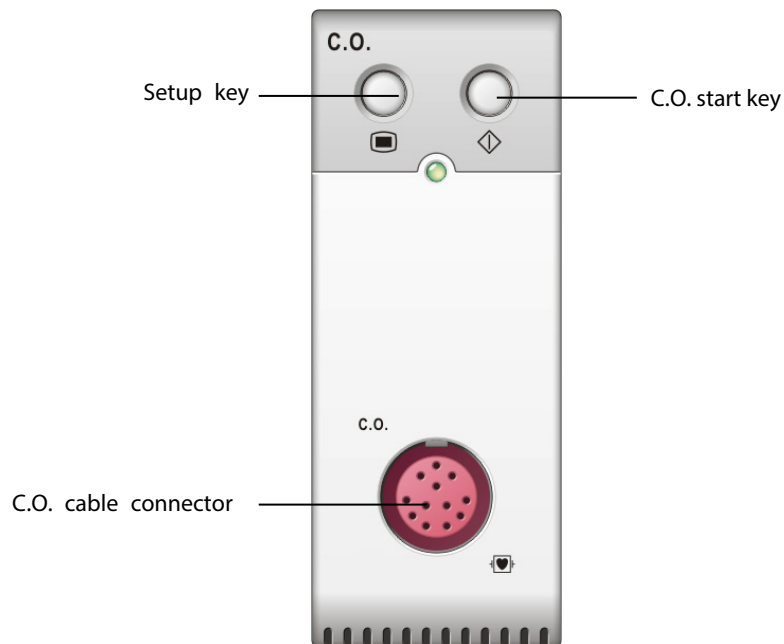

WARNING

- **C.O. monitoring is restricted to adult patients only.**
-

15.2 Understanding the C.O. Display

The C.O. measurement is displayed on the monitor as numeric C.O., C.I. and TB in the C.O. parameter window as shown below. To enter the [C.O. Setup] menu, select the C.O. parameter window.



1. Cardiac output
2. Time at which the C.O. average is calculated
3. Cardiac index
4. Blood temperature

15.3 Influencing Factors

The factors that affect cardiac output are:

- temperature of injectate solution,
- volume of injectate solution,
- patient's baseline blood temperature,
- patient's inspiratory/expiratory cycle,
- placement of catheter with relation to proximity of lung field,
- the catheter itself,
- the patient rhythm and hemodynamic status, and
- any other rapid IV solutions which are infused while the C.O. measurement is being performed.

Following are some technical suggestions to obtain accurate C.O.:

- Injectate solution must be cooler than the patient's blood.
- Inject solution rapidly and smoothly.
- Inject at end of expiration.

15.4 Setting Up the C.O. Measurement

WARNING

- Use only accessories specified in this manual. Make sure that the accessories never come into contact with conductive parts.
-

To set up the C.O. measurement:

1. Connect the C.O. cable to the C.O. connector.
2. Interconnect the C.O. module, catheter and syringe as shown below. Make sure that:
 - ◆ The module is securely inserted.
 - ◆ The PA catheter is in place in the patient.
 - ◆ The C.O. cable is properly connected to the module.

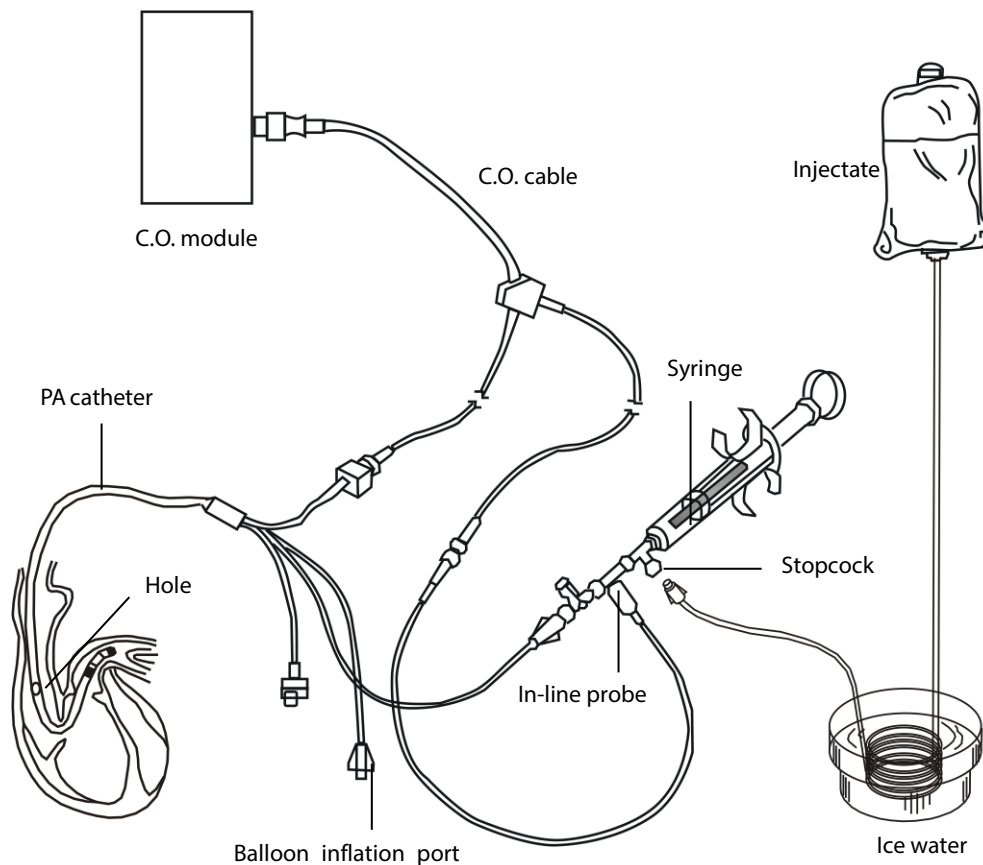

NOTE

- The above picture illustrates when using a TI sensor (PN 6000-10-02079). The connection may be different if other TI sensors are used.
-

3. Select the C.O. parameter window to enter the [**C.O. Setup**] menu. Check if the height and weight are appropriate for your patient. Change if necessary.

4. In the **[C.O. Setup]** menu:
 - ◆ Check that the correct computation constant is entered. Refer to the Instruction for Use of pulmonary artery catheter to determine the **[Comp. Const]** according to the entered injectate volume and temperature. To change the computation constant, select **[Comp. Const]** and then enter the correct value. When a new catheter is used, the computation constant should be adjusted in accordance with the manufacturer's instructions for use.
 - ◆ Set the **[Auto TI]** to **[Manual]** or **[Auto]**. If you select **[Auto]**, the system automatically detects the injectate temperature, and the **[Manual TI (°C)]** is disabled. If you select **[Manual]**, you need to enter the injectate temperature at **[Manual TI (°C)]** manually.
 - ◆ Set the **[Measuring Mode]** to **[Auto]** or **[Manual]**. In **[Auto]** mode, the monitor automatically takes the C.O. measurement after establishing a baseline blood temperature. In **[Manual]** mode, you need to click the **[Start]** button in the C.O. measurements window when the monitor is ready for new C.O. measurement.
5. Select **[Enter C.O. Screen]** to enter the C.O. measurements window.

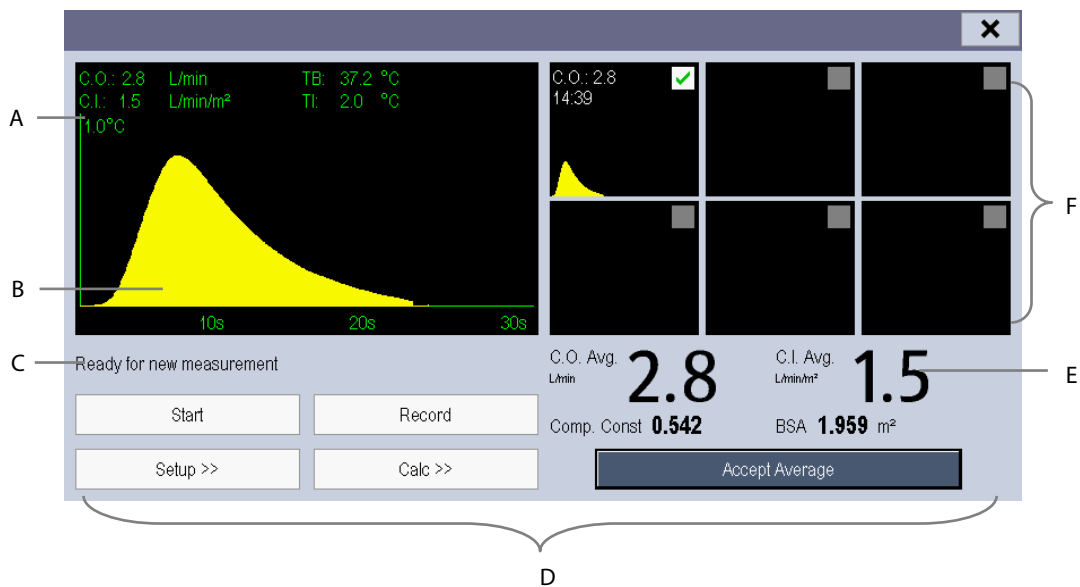

- A. Currently measured numeric
- B. Currently measured C.O. curve
- C. Prompt message area
- D. Buttons
- E. Averaged values
- F. Measurement windows

6. Proceed as follows.
 - ◆ In **[Manual]** measure mode, select the **[Start]** button and then inject the solution quickly when you see the message **[Ready for new set of measurement]**. As shown in the figure above, during the measurement, the currently measured thermodilution curve is displayed. At the end of the measurement, the thermodilution curve is transferred to one of the 6 measurement windows and the monitor prompts you to wait for a certain period of time before starting a new measurement.

- ◆ In **[Auto]** measure mode, the monitor consecutively takes C.O. measurements automatically without the need for pressing the **[Start]** button between two measurements. A new thermodilution measurement is possible as soon as the message **[Inject now!]** is displayed on the screen. The monitor automatically detects further thermodilution measurements.

7. Consecutively take 3 to 5 single measurements as instructed by Step 6.

A maximum of 6 measurements can be stored. If you perform more than six measurements without rejecting any, the oldest will automatically be deleted when a seventh curve is stored. Select from the 6 measurement curves and the system will automatically calculate and display the averaged C.O. and C.I. values. Then select the **[Accept Average]** button to accept and store the averaged values.

When injecting, the stopcock to the PA catheter is open and the stopcock to the injectate solution is closed. After the measurement is completed, turn off the stopcock to the PA catheter and turn on the stopcock to the injectate solution, and then draw the injectate solution into the injectate syringe.

In the buttons area, you can:

- Select **[Start]** to start a C.O. measurement.
- Select **[Stop]** to stop the current measurement.
- Select **[Cancel]** during a measurement to cancel the measurement.
- Select **[Record]** to print out the curves selected for average calculation, numerics and averaged values by the recorder.
- Select **[Setup >>]** to access the **[C.O. Setup]** menu.
- Select **[Calc >>]** → **[Hemodynamic >>]** to access the **[Hemodynamic Calculation]** menu.

The system can automatically adjust the X-axis scale range to 30 s or 60 s and Y-axis scale range to 0.5°C, 1.0°C, or 2.0°C.

CAUTION

- **Starting a measurement without blood temperature being stable may cause measurement failure.**
-

NOTE

- **During a cardiac output measurement, blood temperature alarms are inactive.**
 - **Please refer to the Instructions for Use of pulmonary artery catheter of the monitor to determine the [Comp. Const] and the volume of injectate.**
-

15.5 Measuring the Blood Temperature

As shown below, the blood temperature is measured with a temperature sensor at the distal end of the catheter in the pulmonary artery. During C.O. measurements, blood temperature alarms are suppressed to avoid false alarms. They will automatically recover as soon as the C.O. measurements are completed.

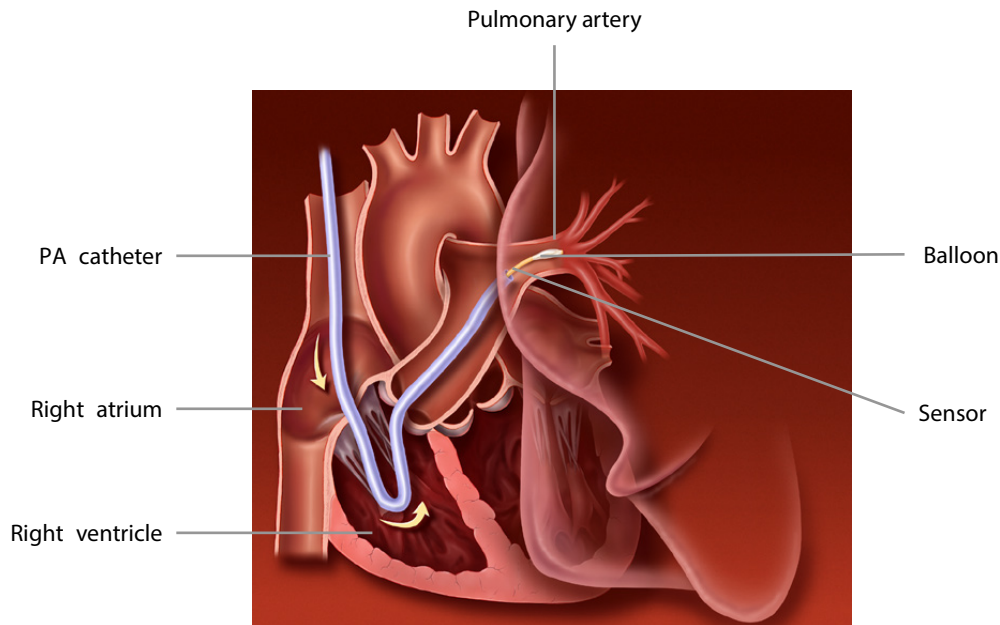

15.6 Changing C.O. Settings

15.6.1 Setting the Temperature Unit

Select [**Unit Setup >>**] from the [**User Maintenance**] menu. In the pop-up menu, select [**Temp Unit**] to toggle between [°C] and [°F].

15.6.2 Setting Alarm Properties

Select [**Alarm Setup >>**] from the [**C.O. Setup**] menu. You can set alarm properties for this parameter in the pop-up menu.

16 Monitoring CCO/SvO₂

16.1 Introduction

The Edwards Vigilance II® monitors, Vigileo™ monitors, and EV1000 monitors measure continuous cardiac output (CCO), mixed venous oxygen saturation (SvO₂), central venous oxygen saturation (ScvO₂) etc. They also calculate hemodynamic and oxygenation parameters. The Passport 12m and Passport 17m monitors can be connected to the Vigilance II® monitor/Vigileo™ monitor / EV1000 monitor and can display, store, and review the measured and calculated parameter values from these monitors. The Passport 12m and Passport 17m monitors can also give alarms of these measured parameters. You must set alarm on/off, alarm limits, alarm level, and alarm record separately on this monitor. The alarm is [Off] by default.

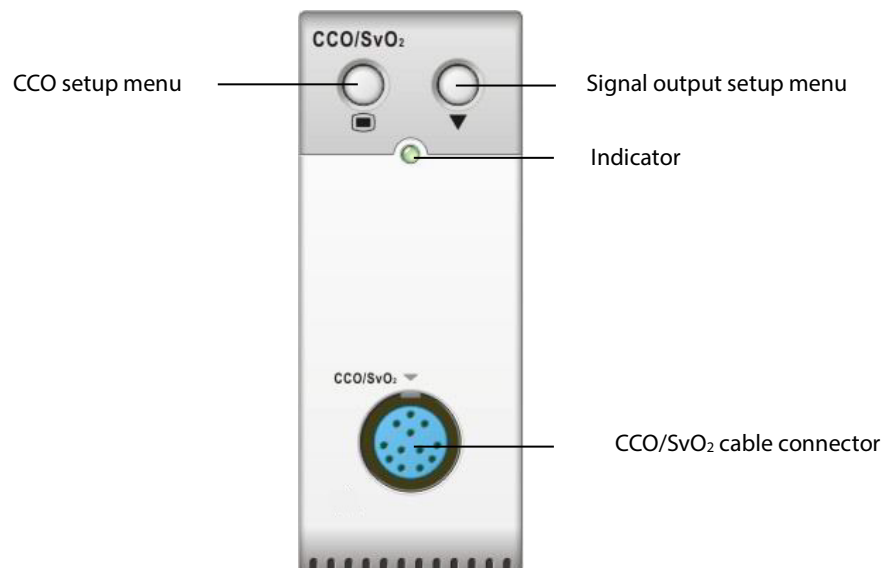

16.2 Safety

WARNING

- **The Vigilance II® monitor, Vigileo™ monitor, and EV1000 monitor are manufactured by Edwards Lifesciences. This company provides the technology of measuring and calculating the relevant parameters. We only provide the connection between this monitor and Vigilance II® monitor/Vigileo™ monitor/ EV1000 monitor.**
 - **If you have any doubts about the operation and maintenance of the Vigilance II® monitor/Vigileo™ monitor/ EV1000 monitor, please read the Operator's Manuals for these monitors or contact Edwards Lifesciences (www.edwards.com) directly.**
 - **Fully observe the Vigilance II® monitor/Vigileo™ monitor/ EV1000 monitor Operator's Manuals to configure settings and to connect the monitor to the patient.**
-

NOTE

- When the Vigilance II® monitor, the Vigileo™ monitor, or the EV1000 monitor is disconnected from the Passport 12m or the Passport 17m monitor, a disconnection alarm is announced. In addition, the CCO numeric area and the SvO₂ /ScvO₂ numeric area disappear from the monitor's screen. To clear the disconnection alarm, please see the ScvO₂ section of *D.2 Technical Alarm Messages*.

16.3 Automatic Communication Detection

The relevant parameter window is not displayed on the screen if this monitor detects communication failure between the CCO/SvO₂ module and Vigilance II® monitor/Vigileo™ monitor/ EV1000 monitor.

16.4 Connecting the Device

16.4.1 Connecting the Vigilance II® Monitor



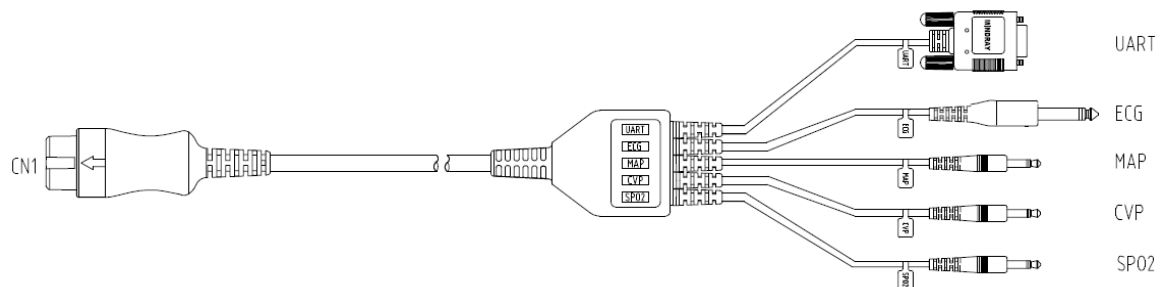

The following figure shows how to connect this monitor to the Vigilance II® monitor through cables.

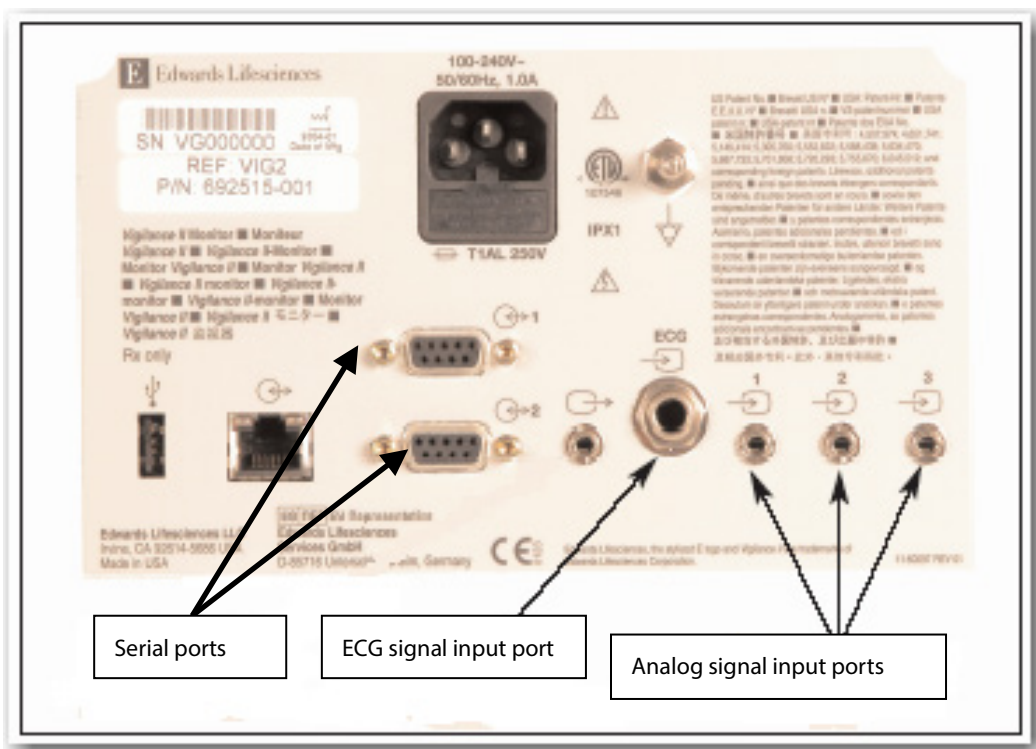

The following figure shows the rear housing of the Vigilance II® monitor.



To connect the Vigilance II® monitor:

1. Connect CN1 with the CCO/SvO₂ connector on the patient monitor.
2. Insert the ECG signal end into the ECG signal input port marked  on the rear housing of the Vigilance II® monitor.
3. Insert the MAP signal end into the analog signal input port 1 marked , the CVP signal end into port 2 marked , and SPO₂ signal end into port 3 marked  respectively on the rear housing of the Vigilance II® monitor.
4. Insert UART into either of the serial ports (marked ) on the rear housing of the Vigilance II® monitor
5. Set the Vigilance II® monitor as follows:
 - Access the [Serial Port Setup] menu.
 - ◆ Set [Device] to [IFMout], [Baud Rate] to [19200], [Parity] to [None], [Stop Bits] to [1], [Data Bits] to [8], and [Flow Control] to [2 s].
 - Access the [Analog Input Setup] menu.
 - ◆ For port 1, set [Parameter] to [MAP], [Voltage Range] to [0-5 v], [Full Scale Range] to 500 mmHg (66.7 kPa), [Simulated High Value] to 500 mmHg (66.7 kPa), and [Simulated Low Value] to 0 mmHg (0.0 kPa).
 - ◆ For port 2, set [Parameter] to [CVP], [Voltage Range] to [0-5 v], [Full Scale Range] to 100 mmHg (13.3 kPa), [Simulated High Value] to 100 mmHg (13.3 kPa), and [Simulated Low Value] to 0 mmHg (0.0 kPa).
 - ◆ For port 3, set [Parameter] to [SaO₂], [Voltage Range] to [0-10 v], [Full Scale Range] to [100%], [Simulated High Value] to [100%], and [Simulated Low Value] to [0%].

Refer to the Vigilance II® Operator's Manual for the operation of the monitor.

WARNING

- **Calibrate the Vigilance II® monitor before monitoring. Refer to the Vigilance II® Operator's Manual for the calibration instructions.**
-
-

NOTE

- **For the Vigilance II® monitor, [Flow Control] must be set to 2 seconds.**
-
-

16.4.2 Connecting the Vigileo™ Monitor

The following figure shows how to connect this monitor to the Vigileo™ monitor through cables.

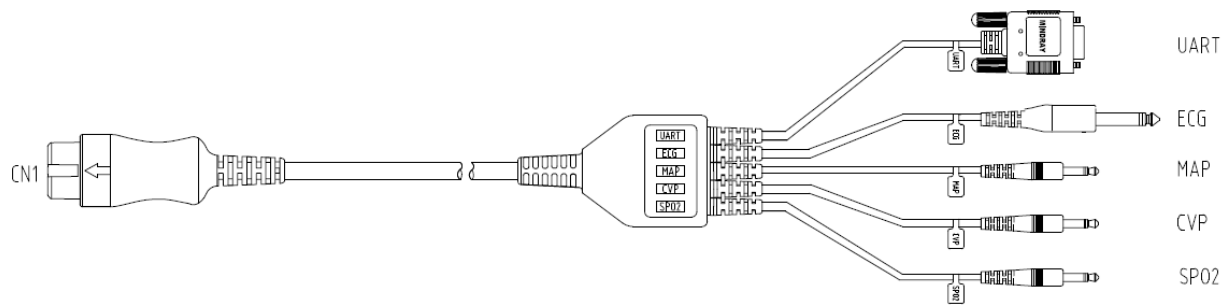

The following figure shows the rear housing of the Vigileo™ monitor.

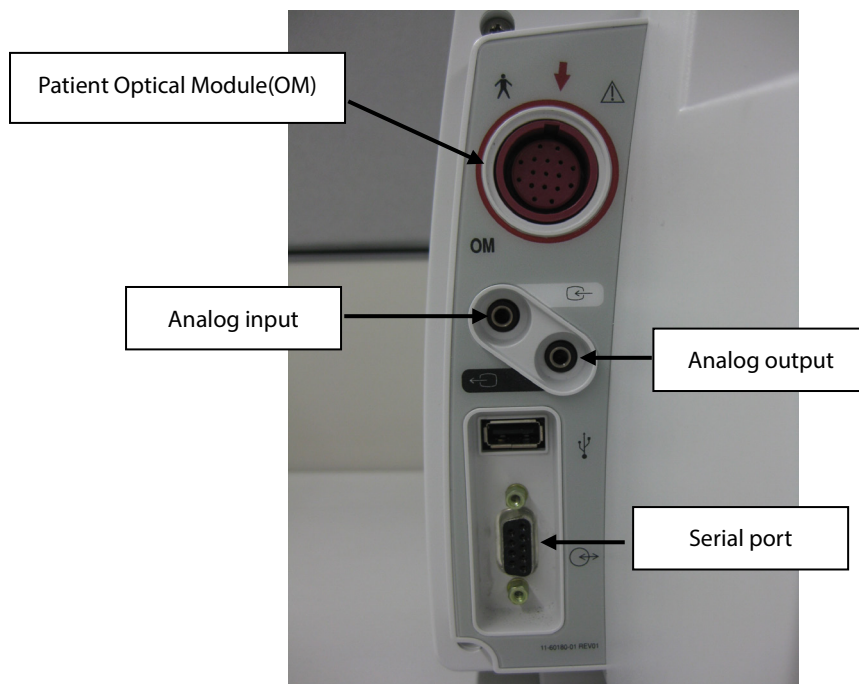

To connect the Vigileo™ monitor:

1. Connect CN1 with the CCO/SvO₂ connector on the monitor.
2. Insert the CVP signal end into the analog signal input port on the rear housing of the Vigileo™ monitor.
3. Insert UART into the serial port on the rear housing of the Vigileo™ monitor.
4. Set the Vigileo™ monitor as follows:
 - Access the **[Serial Port Setup]** menu.
 - ◆ Set **[Device]** to **[IFMout]**, **[Baud Rate]** to **[19200]**, **[Parity]** to **[None]**, **[Stop Bits]** to **[1]**, **[Data Bits]** to **[8]**, and **[Flow Control]** to **[2 seconds]**.
 - Access the **[Analog Input Port Setup]** menu.
 - ◆ Set **[Parameter]** to **[CVP]**, **[Voltage Range]** to **[0-5 v]**, **[Full Scale Range]** to **100 mmHg** (13.3 kPa), **[Simulated High Value]** to **100 mmHg** (13.3 kPa), and **[Simulated Low Value]** to **0 mmHg** (0.0 kPa).

Refer to the Vigileo™ Operator's Manual for the operation of the monitor.

WARNING

- Calibrate the Vigileo™ monitor before monitoring. Refer to the Vigileo™ Operator's Manual for the calibration instructions.
-

NOTE

- For the Vigileo™ monitor, [Flow Control] must be set to 2 seconds.
-

16.4.3 Connecting the EV1000 Monitor

The following figure shows how to connect this monitor to the EV1000 monitor through cables.

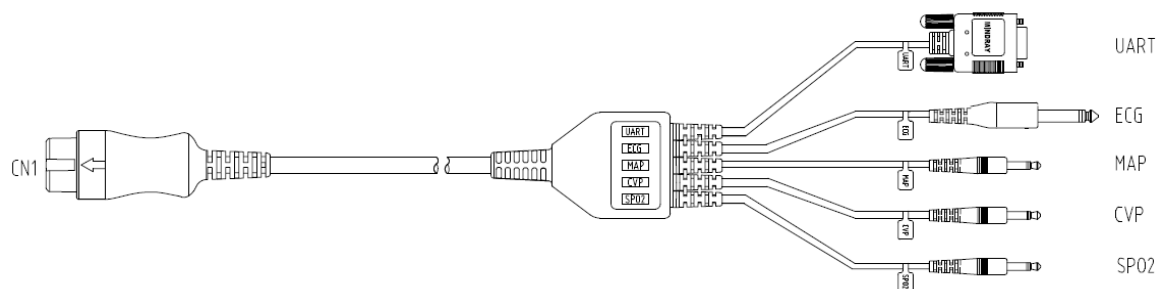

The following figure shows the rear housing of the EV1000 monitor.

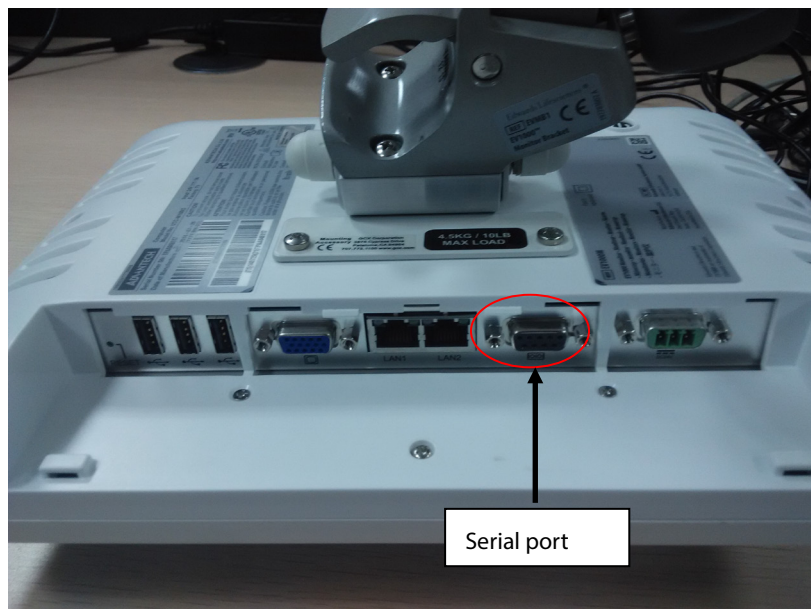

To connect the EV1000 monitor:

1. Connect CN1 with the CCO/SvO₂ connector on the patient monitor.
2. Insert UART into the serial port on the rear housing of the EV1000 monitor.
3. On the main screen of the EV1000 monitor, select the  button to access the [Settings] menu.
4. Select [Monitor Settings] and then select [Serial Port Setup] to access the [Serial Port Setup] menu.
5. Set [Device] to [IFMout], [Baud Rate] to [19200], [Parity] to [None], [Stop Bits] to [1], [Data Bits] to [8], and [Flow Control] to [2 s].

Refer to the EV1000 Operator's Manual for the operation of the monitor.

WARNING

- **Calibrate the EV1000 monitor before monitoring. Refer to the EV1000 Operator's Manual for the calibration instructions.**

16.5 Understanding CCO Parameters

When the monitor is connected to the Vigilance II® monitor/Vigileo™ monitor/EV1000 monitor, select the CCO parameter window → [Hemodynamic Parameters >>] to view the hemodynamic parameters for evaluation of the patient's hemodynamic status.

16.5.1 Hemodynamic Parameters for Vigilance II® Monitor

Abbreviation	Unit	Full Spelling	Measurement Range	Resolution
CCO	L/min	continuous cardiac output	1 to 20 L/min	0.1
CCI	L/min/m ²	continuous cardiac index	0 to 20 L/min/m ²	0.1
C.O.	L/min	cardiac output	1 to 20 L/min	0.1
C.I.	L/min/m ²	cardiac index	0 to 20 L/min/m ²	0.1
EDV	ml	end diastolic volume	40 to 800 ml	1
EDVI	ml/m ²	end diastolic volume index	20 to 400 ml/m ²	1
SV	ml	stroke volume	0 to 300 ml	1
SVI	ml/m ²	stroke volume index	0 to 200 ml/m ²	1
SVR	DS/cm ⁵	systemic vascular resistance	0 to 3000 DS/cm ⁵	1
	kPa-s/l		0 to 300 kPa-s/l	0.1
SVRI	DS·m ² /cm ⁵	systemic vascular resistance index	0 to 6000 DS·m ² /cm ⁵	1
	kPa-s-m ² /l		0 to 600 kPa-s-m ² /l	0.1
RVEF	%	right ventricular ejection fraction	10 to 60%	1
TB	°C	blood temperature	25 to 45 °C	0.1
	°F		77 to 113 °F	0.1
ESV	ml	end systolic volume	10 to 700 ml	1
ESVI	ml/m ²	end systolic volume index	5 to 400 ml/m ²	1

Abbreviation	Unit	Full Spelling	Measurement Range	Resolution
CVP	cmH ₂ O, kPa or mmHg	central venous pressure	0 to 100 mmHg	1
MAP	mmHg or kPa	mean arterial pressure	0 to 500 mmHg	1
HR	rpm	heart rate	30 to 250 bpm	1

16.5.2 Hemodynamic Parameters for Vigileo™ Monitor

Abbreviation	Unit	Full Spelling	Measurement Range	Resolution
CCO	L/min	continuous cardiac output	1 to 20 L/min	0.1
CCI	L/min/m ²	continuous cardiac index	0 to 20 L/min/m ²	0.1
SV	ml	stroke volume	0 to 300 ml	1
SVI	ml/m ²	stroke volume index	0 to 200 ml/m ²	1
SVV	%	stroke volume variation	0 to 99%	0.1
SVR	DS/cm ⁵	systemic vascular resistance	0 to 3000 DS/cm ⁵	1
	kPa-s/l		0 to 300 kPa-s/l	0.1
SVRI	DS-m ² /cm ⁵	systemic vascular resistance	0 to 6000 DS-m ² /cm ⁵	1
	kPa-s-m ² /l	index	0 to 600 kPa-s-m ² /l	0.1
CVP	cmH ₂ O, kPa or mmHg	central venous pressure	0 to 100 mmHg	1

16.5.3 Hemodynamic Parameters for EV1000 Monitor

When the EV1000 monitor is in the FloTrac or ClearSight mode, you can view parameter values for CCO, CCI, SV, SVI, SVV, SVR, SVRI, CVP, and MAP on the Passport 12m and Passport 17m monitors' screen.

When the EV1000 monitor is in the VolumeView mode, you can view parameter values for CCO, CCI, C.O, C.I., SV, SVI, GEF, CFI, GEDV, GEDI, ITBV, ITBI, SVV, SVR, SVRI, EVLW, ELWI, PVPI, TB, CVP, and MAP on the Passport 12m and Passport 17m monitors' screen.

	Abbreviation	Unit	Full Spelling	Measurement Range	Resolution
Output	CCO	L/min	continuous cardiac output	1 to 20 L/min	0.1
	CCI	L/min/m ²	continuous cardiac index	0 to 20 L/min/m ²	0.1
	C.O.	L/min	cardiac output	1 to 20 L/min	0.1
	C.I.	L/min/m ²	cardiac index	0 to 20 L/min/m ²	0.1
	SV	ml	stroke volume	0 to 300 ml	1
	SVI	ml/m ²	stroke volume index	0 to 200 ml/m ²	1
Contractility	GEF	%	global ejection fraction	1 to 99%	1
	CFI	l/min	cardiac function index	1 to 15 L/min	0.1
Preload Volume	GEDV	ml	global end diastolic volume	40 to 4800 ml	1
	GEDI	ml/m ²	global end diastolic volume index	80 to 2400 ml/m ²	1

	Abbreviation	Unit	Full Spelling	Measurement Range	Resolution
	ITBV	ml	intra-thoracic blood volume	50 to 6000 ml	1
	ITBI	ml/m ²	intra-thoracic blood volume index	100 to 3000 ml/ m ²	1
	SVV	%	stroke volume variation	0 to 99%	0.1
	CVP	cmH ₂ O, kPa, or mmHg	central venous pressure	0 to 300 mmHg	1
Afterload	SVR	DS/cm ⁵	systemic vascular resistance	0 to 3000 DS/cm ⁵	1
		kPa-s/l		0 to 300 kPa-s/l	0.1
	SVRI	DS-m ² /cm ⁵	systemic vascular resistance index	0 to 6000 DS-m ² /cm ⁵	1
		kPa-s-m ² /l		0 to 600 kPa-s-m ² /l	0.1
MAP	mmHg or kPa	mean arterial pressure	0 to 300 mmHg	1	
Organ Function	EVLW	ml	extravascular lung water	10 to 5000 ml	1
	ELWI	ml/kg	extravascular lung water index	0 to 50 ml/kg	0.1
	PVPI	none	pulmonary vascular permeability index	0.1 to 9.9	0.1
	TB	°C	blood temperature	15 to 45°C	0.1
°F		59 to 113°F		0.1	

16.6 Understanding the CCO Display

The parameter area displays the parameter measurements from the Vigilance II® monitor/Vigileo™ monitor/EV1000 monitor. You can select the desired parameters to be displayed.

The parameters display differently in the continuous measurement mode and intermittent measurement mode (for the Vigilance II® monitor and Vigileo™ monitor only). You can select the desired parameters to be displayed in both modes. For the configuration of the parameters to be displayed, see section **16.7.2 Selecting the Displayed Parameters**.

16.7 Changing CCO Settings

16.7.1 Selecting Vascular Resistance Unit

To select vascular resistance unit:

1. Access the [**CCO Setup**] menu.
2. Select [**SVR Unit**] and toggle between [**DS/cm5**] and [**kPa-s/l**].

16.7.2 Selecting the Displayed Parameters

16.7.2.1 Selecting the Displayed Parameters for Vigilance II Monitor and Vigileo™ Monitor

To select the parameter to be displayed:

1. Access the [**CCO Setup**] menu.
2. Select [**Select Parameter >>**].
3. Select the parameters to be displayed from the pop-up menu.

16.7.2.2 Selecting the Displayed Parameters for EV1000 Monitor

To select the parameter to be displayed:

1. Access the [**CCO Setup**] menu.
2. Select [**Select Parameter >>**].
3. Set [**Parameter Display**] to [**Absolute**] or [**Indexed**].
4. Select the desired secondary parameters. You can select up to three secondary parameters.

16.7.3 Checking the C.O. Measurements

When the monitor is connected to the Vigilance II® monitor, you can check the C.O. measurements in the intermittent measurement mode.

To check the C.O. measurements:

1. Access the [**CCO Setup**] menu.
2. Select [**C.O. Measurements >>**].

16.7.4 Setting Signal Output

- When the monitor is connected to the Vigilance II® monitor:

This monitor outputs analog signals for the Vigilance II® monitor. You can select [**Signal Output Setup >>**] from the [**CCO Setup**] menu to set the source of MAP signals. You can also select [**Simulated High Value**] or [**Simulated Low Value**] to provide simulated high value or low value signals for calibrating the Vigilance II® monitor. Refer to the Vigilance II® Operator's Manual for the calibration of the monitor.

- When the monitor is connected to the Vigileo™ monitor:

Select [**Signal Output Setup >>**] from the [**CCO Setup**] menu. In the pop-up menu, you can select [**Simulated High Value**] or [**Simulated Low Value**] to provide simulated high value or low value signals for calibrating the Vigileo™ monitor. Refer to the Vigileo™ Operator's Manual for the calibration of the monitor.

16.7.5 Selecting Alarm Properties

You can select [**Alarm Setup >>**] from the [**CCO Setup**] menu to set the parameter alarm properties.

WARNING

- **Because the alarm limits of the relevant measured parameters can be set on this monitor, the alarms of these parameters may be different from those on the Vigilance II® monitor/Vigileo™ monitor/EV1000 monitor. Please pay special attention to the alarms on the Vigilance II® monitor /Vigileo™ monitor/EV1000 monitor.**
 - **The alarm of the relevant measured parameters on this monitor is Off by default. Please pay special attention to the alarms on the Vigilance II® monitor/Vigileo™ monitor/EV1000 monitor.**
-

The following table lists the alarm limits for hemodynamic parameters that come from Vigilance II® Monitor, Vigileo™ Monitor, and EV1000 Monitor.

Alarm Limit	Range	Step	Applicable For
CCO High	(Low limit+0.1) to 25 L/min	0.1 L/min	Vigilance II® Monitor , Vigileo™ Monitor, and EV1000 Monitor
CCO Low	0.3 to(high limit-0.1)L/min		
CCI High	(Low limit+0.1) to 15 L/min/m ²	0.1 L/min/m ²	
CCI Low	0.1 to(high limit-0.1)L/min/m ²		
EDV High	(Low limit+10)to 800 ml	10 ml	Vigilance II® Monitor
EDV Low	0 to (high limit-10)ml		
EDVI High	(Low limit+10) to 400 ml/m ²	10 ml/m ²	
EDVI Low	0 to (high limit-10)ml/m ²		
SVR High	(Low limit+20) to 5000 DS/cm ⁵ or (low limit+2) to 500 kPa-s/l	20 DS/cm ⁵ or 2 kPa-s/l	Vigilance II® Monitor , Vigileo™ Monitor, and EV1000 Monitor
SVR Low	0 to (high limit-20)DS/cm ⁵ or 0 to (high limit-2)kPa-s/l		
SVRI High	(Low limit+50) to 9950 DS·m ² /cm ⁵ or (low limit+5) to 995 kPa-s-m ² /l	50 DS·m ² /cm ⁵ or 5 kPa-s-m ² /l	

Alarm Limit	Range	Step	Applicable For
SVRI Low	0 to (high limit-5)DS·m ² /cm ⁵ or 0 to (high limit-5)kPa·s·m ² /l		
SV High	(Low limit+5) to 300 ml	5 ml	
SV Low	0 to (high limit-5)ml		
SVI High	(Low limit+5) to 200 ml /m ²	5 ml /m ²	
SVI Low	0 to (high limit-5)ml /m ²		
RVEF High	(Low limit+5) to 100 %	5 %	Vigilance II® Monitor
RVEF Low	0 to (High limit-5)%		
SVV High	(Low limit+1) to 100 %	1%	Vigileo™ Monitor, and EV1000 Monitor
SVV Low	0 to (high limit-1)%		

16.8 Understanding SvO₂/ScvO₂ Parameters

When the monitor is connected to the Vigilance II® monitor/Vigileo™ monitor/EV1000 monitor, you can view all the oxygenation parameters.

To view the oxygenation parameters, following this procedure:

1. Select the SvO₂ parameter window to enter the [**SvO₂ Setup**] menu, or select the ScvO₂ parameter window to enter the [**ScvO₂ Setup**] menu.
2. Select [**Oxygenation Parameters >>**].

16.8.1 Oxygenation Parameters for Vigilance II® Monitor

Abbreviation	Unit	Full Spelling	Measurement Range	Resolution
SvO ₂	%	mixed venous oxygen saturation	0 to 99%	1
ScvO ₂	%	central venous oxygen saturation	0 to 99%	1
SaO ₂	%	arterial oxygen saturation	40 to 100%	1
DO ₂	ml/min	oxygen delivery	0 to 2000 ml/min	1
VO ₂	ml/min	oxygen consumption	0 to 999 ml/min	1
O ₂ El	%	oxygen extraction index	0.0 to 99.9%	0.1

16.8.2 Oxygenation Parameters for Vigileo™ Monitor

Abbreviation	Unit	Full Spelling	Measurement Range	Resolution
SvO ₂	%	mixed venous oxygen saturation	0 to 99%	1
ScvO ₂	%	central venous oxygen saturation	0 to 99%	1

16.8.3 Oxygenation Parameters for EV1000 Monitor

Abbreviation	Unit	Full Spelling	Measurement Range	Resolution
SvO ₂	%	mixed venous oxygen saturation	0 to 99%	1
ScvO ₂	%	central venous oxygen saturation	0 to 99%	1
DO ₂	ml/min	oxygen delivery	0 to 2000 ml/min	1
DO ₂ I	ml/min/m ²	oxygen delivery index	10 to 5000 ml/min/m ²	1
VO ₂	ml/min	oxygen consumption	0 to 999 ml/min	1
VO ₂ I	ml/min/m ²	oxygen consumption index	10 to 5000 ml/min/m ²	1
VO ₂ e	ml/min	estimated oxygen consumption index when ScvO ₂ is being monitored	0 to 999 ml/min	1
VO ₂ Ie	ml/min/m ²	estimated oxygen consumption index	10 to 999 ml/min/m ²	1
Hb	g/L, g/dl or mmol/L	hemoglobin	20.0 to 318.0-g/L 2.0 to 31.8 g/dl 1.2 to 19.7mmol/L	0.1
SpO ₂	%	arterial oxygen saturation from pulse oximetry	0 to 100 %	1

16.9 Understanding the SvO₂/ScvO₂ Display

Depending on the setup of the Vigilance II® monitor, Vigileo™ monitor, or EV1000 monitor, the monitor displays either the SvO₂ numeric area or ScvO₂ numeric area.

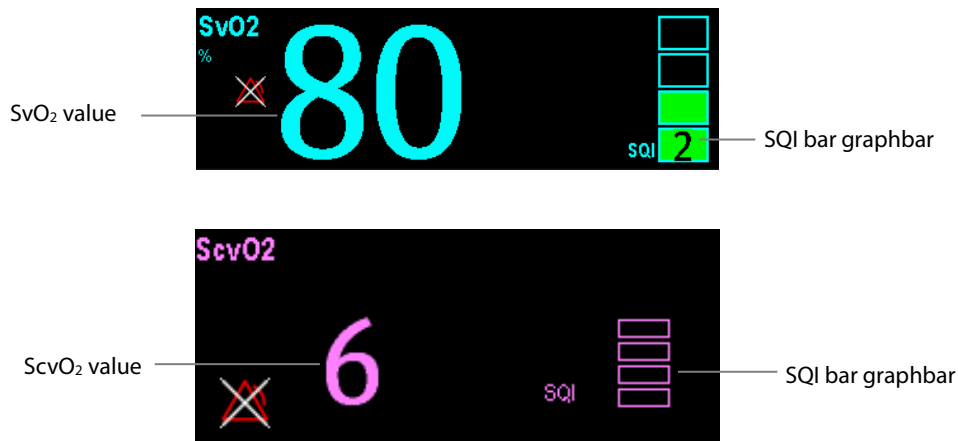

NOTE

- When EV1000 monitor works in ClearSight mode, neither the SvO₂ numeric area nor the ScvO₂ numeric area is displayed on the monitor's screen.

16.10 Changing SvO₂/ScvO₂ Settings

16.10.1 Setting Signal Output

This monitor outputs analog signals for the Vigilance II® monitor. You can select **[Signal Output Setup >>]** from the **[SvO₂ Setup]** menu or **[ScvO₂ Setup]** menu to set the source of MAP signals. You can also select **[Simulated High Value]** or **[Simulated Low Value]** to provide simulated high value or low value signals for the Vigilance II® monitor. Refer to the Vigilance II® Operator's Manual for the monitor calibration.

16.10.2 Selecting Alarm Properties

When the monitor is connected to the Vigilance II® monitor or EV1000 monitor, select the SvO₂ or ScvO₂ parameter area to enter the **[SvO₂ Setup]** or **[ScvO₂ Setup]** menu and then select **[Alarm Setup]** to set the alarm properties for relevant parameters.

When the monitor is connected to the Vigileo™ monitor, select the SvO₂ or ScvO₂ parameter area to enter the **[Alarm Setup]** menu and set the alarm properties for relevant parameters.

The following table lists the alarm limits for oxygenation parameters that come from Vigilance II® Monitor, Vigileo™ Monitor, and EV1000 Monitor.

Alarm Limit	Measurement Range	Resolution	Applicable For
SvO ₂ High	(Low limit+1) to 99%	1	Vigilance II® Monitor, Vigileo™ Monitor, and EV1000 Monitor
SvO ₂ Low	0 to (High limit-1)%		
ScvO ₂ High	(Low limit+1) to 99%		
ScvO ₂ Low	0 to (High limit-1)%		

FOR YOUR NOTES

17 Monitoring ScvO₂

17.1 Introduction

Central venous oxygen saturation (ScvO₂) is measured across spectrophotometry. Spectrophotometry involves the use of light emitting diodes (LED) that produce light of various wavelengths in red and infrared spectra. The light is transmitted to the blood through a fiberoptic in the probe, reflected off the red blood cells and transmitted back through a separate fiberoptic to an optical module. The central venous oxygen saturation is calculated through the analysis of the reflected spectra.

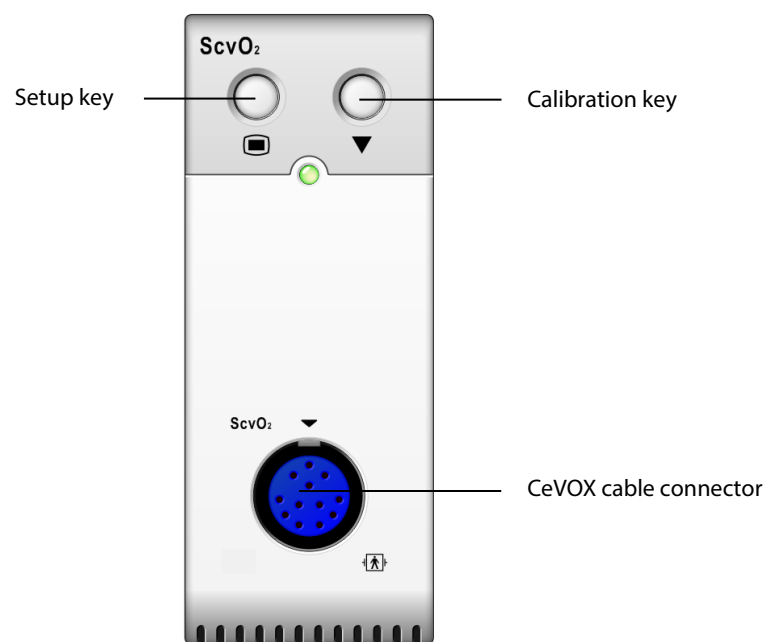

17.2 Safety Information

WARNING

- ScvO₂ monitoring is limited to adult and pediatric patients.
-

NOTE

- For ScvO₂ monitoring using the Edwards Vigilance II monitor, Vigileo™ monitor, or EV1000 monitor, please see *Chapter 16 Monitoring CCO/ SvO₂*.
-

17.3 Performing ScvO₂ Measurements

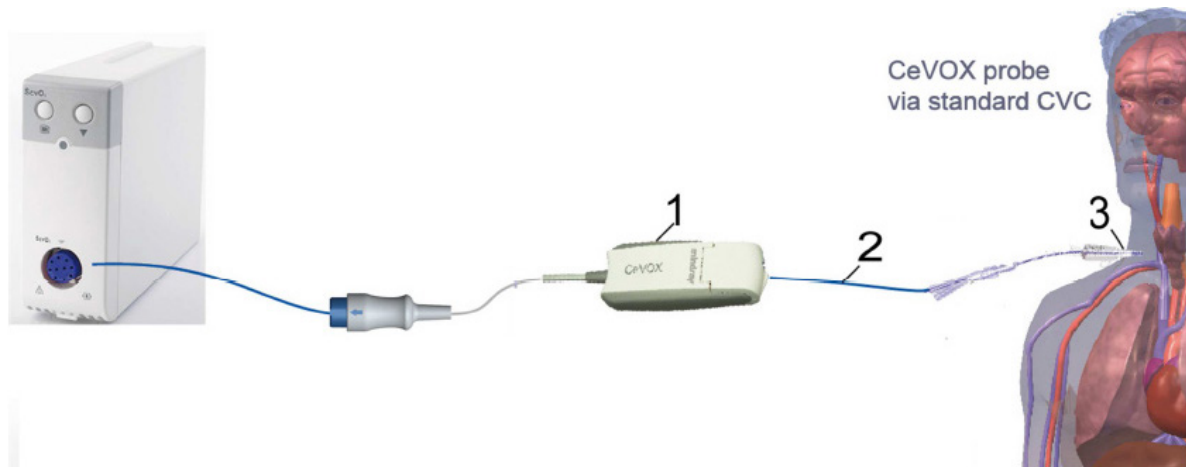

1. CeVOX optical module
2. CeVOX fiberoptic probe
3. Central venous catheter

To perform the ScvO₂ measurements:

1. Apply the central venous catheter.
2. Place one end of the fiberoptic probe into the central venous catheter through the distal lumina, and connect the other end to the CeVOX optical module. Then plug the CeVOX cable into the ScvO₂ module.
3. If you see the message [**Calibration Required**], calibrate the ScvO₂ before performing the measurements. For detailed information on ScvO₂ calibration, please see section **17.4 ScvO₂ Calibration**.
4. Check the reading in the ScvO₂ parameter window.

WARNING

- To avoid installation failure, ensure that the proper fiberoptic probe is selected.
 - Incorrect placement of the fiberoptic probe can lead to vessel perforation. Therefore check the correct position of the probe as indicated in the probe's instructions for use.
-

17.4 ScvO₂ Calibration

Regular in vivo calibration is required using blood gas analysis of a central venous blood sample to ensure accurate measurement of continuous ScvO₂. For optimal accuracy, it is recommended that an in vivo calibration be performed at least every 24 hours or if hemoglobin is changing (for more details, check the notes below).

To perform calibration:

1. Check the central venous catheter and CeVOX probe for proper placement.
2. Check the quality of the signal. The Signal Quality Indicator (SQI) is used for assessing the quality of fiberoptical signals during probe placement, calibration and measurement. The signal quality is indicated by bars of different height levels. Generally, the higher the level, the better the signal.
3. Withdraw a sufficient amount of central venous blood from the side port of the CeVOX probe to avoid intermixture of infusion/injection with the withdrawn blood.
4. Slowly withdraw 2ml blood from the side port of the CeVOX probe. Do not pull too strongly in order to avoid a hemolysis.
5. Immediately confirm by pressing the [**Sample drawn**] button.
6. If necessary put blood sample on ice and perform an analysis by a blood gas analysis device or a laboratory oximeter.
7. Input lab values for Hb/Hct and ScvO₂ and press [**Calibrate**] to confirm.

NOTE

- **The SQI signal can be affected by the presence of electrosurgical units. Keep electrocautery equipment and cables away from the monitor and use separate power socket if possible.**
- **To achieve optimal accuracy, it is recommended that the entered hemoglobin and hematocrit values are updated when there is a change of 6 % or more in hematocrit, or of 1.8 g/dl (1.1 mmol/l) or more in hemoglobin. A change in hemoglobin may also affect SQI.**
- **Dye (e.g. Indocyanine Green) or other substances, containing dyes which usually modify the light absorption capacities, can lead to faulty measurement values of the oxygen saturation.**

17.5 Understanding the ScvO₂ Display



17.6 Understanding ScvO₂ Parameters

Apart from ScvO₂, the monitor can also monitor DO₂, VO₂, DO₂I, and VO₂I. You can access the [**ScvO₂ Calibration**] menu from the [**ScvO₂ Setup**] menu and input a SaO₂ value in [**SaO₂**] edit box. The monitor will calculate the values for oxygenation parameters automatically, and display these parameters at [**Oxygention Parameters**] in the [**ScvO₂ Setup**] menu. If a parameter value exceeds its normal range, the system will add a " ↑ " or " ↓ " to the right of the parameter.

WARNING

- **The monitor may only be regarded as a device providing early warning. If there is an indication of a trend towards de-oxygenation of the patient, blood samples must be taken and tested on a laboratory oximeter in order to arrive at a decision concerning the condition of the patient.**
-
-

17.7 Changing ScvO₂ Settings

17.7.1 Selecting Hb/Hct

To select Hb/Hct:

1. Open the [**ScvO₂ Setup**] menu.
2. Select [**Hb/Hct**] and then select [**Hb**] or [**Hct**].

17.7.2 Selecting Alarm Properties

Select [**Alarm Setup >>**] from the [**ScvO₂ Setup**] menu to set the alarm properties for the relevant parameters.

18 Monitoring CO₂

18.1 Introduction

CO₂ monitoring is a continuous, non-invasive technique for determining the concentration of CO₂ in the patient's airway by measuring the absorption of infrared (IR) light of specific wavelengths. CO₂ has its own absorption characteristic and the amount of light passing the gas probe depends on the concentration of the measured CO₂. When a specific band of IR light passes through respiratory gas samples, some of IR light will be absorbed by the CO₂ molecules. The amount of IR light transmitted after it has been passed through the respiratory gas sample is measured with a photodetector. From the amount of IR light measured, the concentration of CO₂ is calculated.

Sidestream/Microstream measurement samples expired patient gas at a constant sample flow from the patient's airway and analyzes it with a CO₂ sensor built into the CO₂ module.

The sidestream and microstream CO₂ measurement can be used, with specified accessories, with intubated and non-intubated adult, pediatric, and neonatal patients. With intubated patients, a sample of the respiratory gas is drawn from the patient's breathing circuit through an airway adapter and a gas sampling line. With non-intubated patients, the gas sample is drawn through a nasal cannula.

The measurement provides:

- A CO₂ waveform
- End tidal CO₂ value (EtCO₂): the CO₂ value measured at the end of the expiration phase.
- Fraction of inspired CO₂ (FiCO₂): the smallest CO₂ value measured during inspiration.
- Airway respiration rate (awRR): the number of breaths per minute, calculated from the CO₂ waveform.

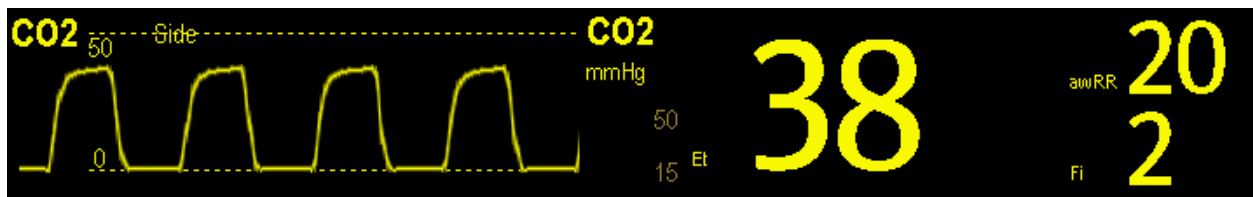

18.2 Identifying CO₂ Modules

From left to right are sidestream CO₂ module (2 slots), sidestream CO₂ 1.0 module(1 slot)/sidestream CO₂ 2.0 module (1 slot), and microstream CO₂ module.

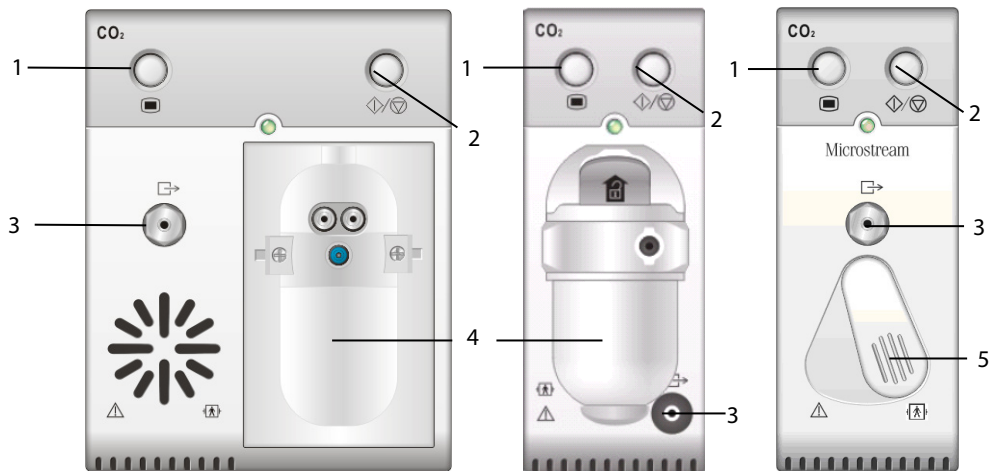

1. Setup key to enter the CO₂ setup menu
2. Measure/standby
3. Gas outlet
4. CO₂ watertrap seat
5. Sampling line connector

If you measure CO₂ using the AG module, see the chapter **19 Monitoring AG**.

NOTE

-
- The 1-slot sidestream CO₂ 2.0 module is supported by the software version 05.40.00 and above.
-

18.3 Preparing to Measure CO₂

WARNING

-
- Check that the alarm limit settings are appropriate before taking measurement.
 - Eliminate the exhausted gas before performing the measurement.
-

NOTE

-
- Perform the measurement in a well-ventilated environment.
-

18.3.1 Making a Sidestream CO₂ Measurement

To make a sidestream CO₂ measurement:

1. Attach the watertrap to the module and then connect the CO₂ components as shown below.

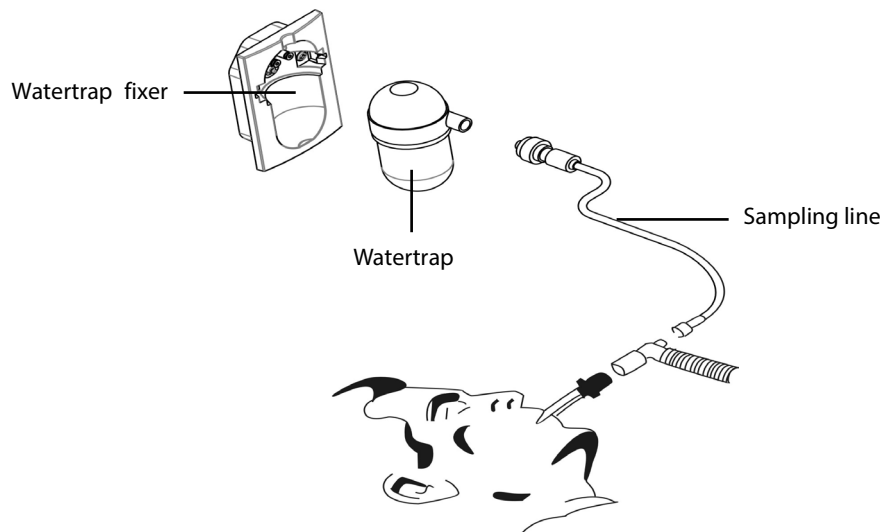

2. Plug the CO₂ module into the monitor.
3. The CO₂ module needs time to warm up to reach operating temperature. The message [CO₂ Sensor Warmup] is displayed during warm-up.
4. After warm-up is finished, you can perform CO₂ measurements.

CAUTION

- The watertrap collects water drops condensed in the sampling line and therefore prevents them from entering the module. To avoid blocking the airway, empty the watertrap container whenever half full. Dispose of accumulated fluids in accordance with hospital policy or your local regulations.
- The watertrap has a filter preventing bacterium, water and secretions from entering the module. After long-term use, dust or other substances may compromise the performance of the filter or even block the airway. In this case, replace the watertrap. It is recommended that you replace the watertrap once a month, or when the watertrap is found leaky, damaged or contaminated.
- Do not apply adult watertrap to the neonate patient. Otherwise, patient injury could result.

NOTE

- To extend the lifetime of the watertrap and module, disconnect the watertrap and set the operating mode to the standby mode when CO₂ monitoring is not required.
-

18.3.2 Making a Microstream CO₂ Measurement

Connect the sampling line to the module and then connect the CO₂ components as shown below. After warm-up is finished, you can perform CO₂ measurements.

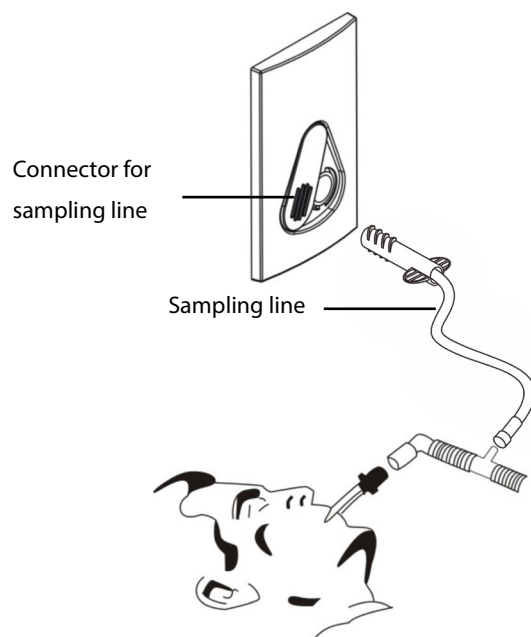

18.4 Changing CO₂ Settings

18.4.1 Accessing CO₂ Menus

By selecting the CO₂ parameter window, you can access the [CO₂ Setup] menu.

18.4.2 Setting the CO₂ Unit

To set the CO₂ Unit:

1. Select [Main Menu]→[Maintenance >>]→[User Maintenance]→enter the required password →[Unit Setup >>].
2. In the Unit Setup menu, select [CO₂ Unit] and then select [mmHg], [%] or [kPa].

18.4.3 Setting Up Gas Compensations

WARNING

- **Make sure to use the appropriate compensations. Inappropriate compensations may cause inaccurate measurement values and result in misdiagnosis.**
-

For the sidestream CO₂ module:

1. Select [**CO₂ Setup**].
2. According to the actual condition, set the concentration required for the following compensations:
 - ◆ [**O₂ Compen**]
 - ◆ [**N₂O Compen**]
 - ◆ [**Des Compen**]

For the microstream CO₂ module, gas compensations are not required.

18.4.4 Setting Up Humidity Compensation

Sidestream and microstream CO₂ modules are configured to compensate CO₂ readings for either Body Temperature and Pressure, Saturated Gas (BTPS), to account for humidity in the patient's breath, or Ambient Temperature and Pressure, Dry Gas (ATPD).

1. ATPD: $P_{CO_2}(mmHg) = CO_2(vol\%) \times P_{amb}/100$
2. BTPS: $P_{CO_2}(mmHg) = CO_2(vol\%) \times (P_{amb} - 47)/100$

Where, P_{CO_2} = partial pressure, $vol\%$ = CO₂ concentration, P_{amb} = ambient pressure, and unit is mmHg.

For the sidestream and microstream CO₂ module, you can set the humidity compensation on or off according to the actual condition.

To set the humidity compensation:

1. Select the CO₂ parameter window to access the [**CO₂ Setup**] menu, and then select [**BTPS Compen**].
2. Select either [**On**] for BTPS or [**Off**] for ATPD, depending on which compensation applies.

18.4.5 Setting the Apnea Alarm Delay

To set the apnea alarm delay:

1. Select the CO₂ parameter window to access the **[CO₂ Setup]** menu.
2. Select **[Apnea Delay]** and then select the appropriate setting.

The monitor will alarm if the patient has stopped breathing for longer than the selected apnea time. The setting of **[Apnea Delay]** takes effect simultaneously to the Resp, CO₂, AG, and RM modules.

WARNING

- **The respiration measurement does not recognize the cause of apneas. It only indicates an alarm if no breath is detected when a pre-adjusted time has elapsed since the last detected breath. Therefore, it cannot be used for diagnostic purposes.**
-

18.4.6 Choosing a Time Interval for Peak-Picking

For microstream CO₂ modules, you can select a time interval for picking the highest CO₂ as the EtCO₂ and the lowest as the FiCO₂.

To set the time interval:

1. Select the CO₂ parameter window to access the **[CO₂ Setup]** menu.
2. Select **[Max Hold]**.
3. Select **[Single Breath]**, **[10 s]**, **[20 s]** or **[30 s]**:
 - ◆ **[Single Breath]**: EtCO₂ and FiCO₂ are calculated for every breath.
 - ◆ **[10 s]**, **[20 s]**, or **[30 s]**: EtCO₂ and FiCO₂ are calculated using 10, 20 or 30 seconds of data.

18.4.7 Setting the Flow Rate

For the sidestream CO₂ module, you can change the sampling rate of respiratory gas in the patient's airway by setting the flow rate.

To set the flow rate:

1. Select the CO₂ parameter window to access the **[CO₂ Setup]** menu.
2. Select an appropriate setting from **[Flow Rate]**.

WARNING

- **Please consider the patient's actual bearing capability and then select the appropriate flow rate.**
-

18.4.8 Setting up the CO₂ Wave

Select the CO₂ parameter window to access the **[CO₂ Setup]** menu, in which you can:

- Select **[Wave Type]** and then select **[Draw]** or **[Fill]**:
 - ◆ **[Draw]**: The CO₂ wave is displayed as a curved line.
 - ◆ **[Fill]**: The CO₂ wave is displayed as a filled area.
- Select **[Sweep]** and then select the appropriate setting. The faster the wave sweeps, the wider the wave is.
- Change the size of the CO₂ waveform by adjusting the wave **[Scale]**.

18.4.9 Setting RR Source

To set RR source:

1. Select the CO₂ parameter window to access the **[CO₂ Setup]** menu.
2. Select **[RR Source]** and then select a source or **[Auto]** from the dropdown list.

The **[RR Source]** setting takes effect simultaneously to the Resp, CO₂, AG and RM modules. For details, please refer to section **9.9 Setting Respiration Rate (RR) Source**.

18.4.10 Barometric Pressure Compensation



Both sidestream and microstream CO₂ modules have the function of automatic barometric pressure compensation (the system automatically measures the barometric pressure which the patient monitor is exposed to).

18.4.11 Entering the Standby Mode

The Standby mode of the CO₂ module relates to the Standby mode of the monitor as follows:

- If the monitor enters the Standby mode, the CO₂ module also enters the Standby mode.
- If the monitor exits the Standby mode, the CO₂ module also exits the Standby mode.
- If the CO₂ module enters or exits the Standby mode, it does not affect the monitor.

To enter or exit the Standby mode manually:

- select the /  hardkey on the module, or
- select **[Operating Mode]** in the **[CO₂ Setup]** menu and then select **[Standby]** or **[Measure]**.

When you set the sidestream CO₂ module to the Standby mode, the CO₂ gas sample intake pump automatically sets the sample flow rate to zero. When exiting the Standby mode, the CO₂ module continues to work at the previously set sample flow rate.

For the sidestream CO₂ module, you can set the delay time after which, the CO₂ module will enter the Standby mode if no breath is detected.

For the microstream CO₂ module, you can also set a period of time after which the CO₂ module enters the Standby mode if no breath is detected, or since the CO₂ module was powered on, or since the CO₂ module was switched to the measuring mode, or the automatic Standby time is re-set.

To set the standby time:

1. Select the CO₂ parameter window to access the **[CO₂ Setup]** menu.
2. Select **[Auto Standby]** and then select the appropriate setting.

18.5 Measurement Limitations

Some adverse effects can influence the CO₂ performance.

CAUTION

- **The following factors may influence the accuracy of measurement:**
 - ◆ Leaks or internal venting of sampled gas
 - ◆ Mechanical shock
 - ◆ Cyclic pressure up to 10 kPa (100 cmH₂O)
 - ◆ Other sources of interference, if any
 - **Measurement accuracy may be affected by the breath rate and I/E ratio as follow:**
 - ◆ etCO₂ is within specification for breath rate ≤ 60 bpm and I/E ratio ≤ 1:1;
 - ◆ etCO₂ is within specification for breath rate ≤ 30 bpm and I/E ratio ≤ 2:1.
 - **Measurement accuracy is unspecified for breath rate larger than 60 bpm.**
-

18.6 Leakage test

When the sidestream CO₂ modules need maintenance, the monitor displays the message in the CO₂ waveform window: **[Need maintenance. Enter CO₂ setup menu.]**. Then:

1. Select **[Main Menu]**→**[Maintenance >>]**→**[User Maintenance >>]**→enter the required password→**[Module Maintenance >>]**→**[Maintain CO₂]**.
2. Perform leakage test according to the prompt messages on the menu.

18.7 Troubleshooting the Sidestream CO₂ Sampling System

When the sampling system of the sidestream CO₂ module does not work correctly, check to see if the sampling line is kinked. If the sampling line is not kinked, remove it from the watertrap. If the monitor gives a message indicating the sampling system still does not work correctly, it indicates that the watertrap is blocked and it should be replaced with a new one. Otherwise, the sampling line is blocked and should be replaced with a new one.

18.8 Removing Exhaust Gases from the System

WARNING

- **Anesthetics: When using the Sidestream or Microstream CO₂ measurement on patients who are receiving or have recently received anesthetics, connect the outlet to a scavenging system to avoid exposing medical staff to anesthetics.**
-

To remove the sample gas to a scavenging system, connect an exhaust tube to the gas outlet connector of the module.

18.9 Zeroing the Sensor

Zero calibration eliminates the effect of baseline drift during CO₂ measurement exerted on the readings and therefore maintains the accuracy of the CO₂ measurements.

For sidestream and microstream CO₂ modules, a zero calibration is carried out automatically when necessary. You can also start a manual zero calibration if necessary.

To manually start a zero calibration:

1. Select **[Main Menu]**→**[Maintenance >>]**→**[User Maintenance >>]**→enter the required password→**[Maintain CO₂ >>]**.
2. Select **[Calibrate CO₂ >>]**→**[Start Zero Cal.]**.

Disconnecting the patient airway is not required when performing a zero calibration.

WARNING

- **Do not rely on the readings during zeroing.**
-
-

18.10 Calibrating the Sensor

For sidestream or microstream CO₂ modules, a calibration should be performed once every year or when the readings go far beyond the range. For details, refer to the chapter **34 User Maintenance**.

18.11 Oridion Information

Microstream

■ Oridion Patents

This posting serves as notice under 35 U.S.C. § 287(a) for Covidien patents: <http://www.covidien.com/patents>.

■ No Implied License

Possession or purchase of this device does not convey any express or implied license to use the device with unauthorized CO₂ sampling consumables which would, alone, or in combination with this device, fall within the scope of one or more of the patents relating to this device and/or CO₂ sampling consumable.

19 Monitoring AG

19.1 Introduction

The anaesthetic gas (AG) module measures the patient's anaesthetic and respiratory gases by connecting to the airway of intubated patients or collecting the gases with specified accessories. It also incorporates the features of the O₂ module and BIS module. The AG measurement is applicable for adult, pediatric and neonatal patients.

The AG module determines the concentration of certain gases using the infrared (IR) light absorption measurement. The gases that can be measured by the AG module absorb IR light. Each gas has its own absorption characteristic. The gas is transported into a sample cell, and an optical IR filter selects a specific band of IR light to pass through the gas. For multiple gas measurements, there are multiple IR filters. The higher the concentration of gas in a given volume the more IR light is absorbed. This means that higher concentration of IR absorbing gas cause a lower transmission of IR light. The amount of IR light transmitted after it has been passed through an IR absorbing gas is measured. From the amount of IR light measured, the concentration of gas present can be calculated.

Oxygen does not absorb IR light as other breathing gases and is therefore measured relying on its paramagnetic properties. Inside the O₂ sensor are two nitrogen-filled glass spheres mounted on a strong rare metal taut-band suspension. This assembly is suspended in a symmetrical non-uniform magnetic field. In the presence of paramagnetic oxygen, the glass spheres are pushed further away from the strongest part of the magnetic field. The strength of the torque acting on the suspension is proportional to the oxygen concentration. From the strength of the torque, the concentration of oxygen is calculated.

NOTE

- **The AG modules are configured with automatic barometric pressure compensation function.**
- **Perform the measurement in a well-ventilated environment.**

19.2 Identifying AG Modules

The AG module can identify two anaesthetic gases in a mixture automatically and distinguish between them according to their contributions to the MAC value for display as the primary and secondary anaesthetic agents. The AG module cannot be used outside healthcare facilities or during patient transfer.

- Example of three-slot AG module

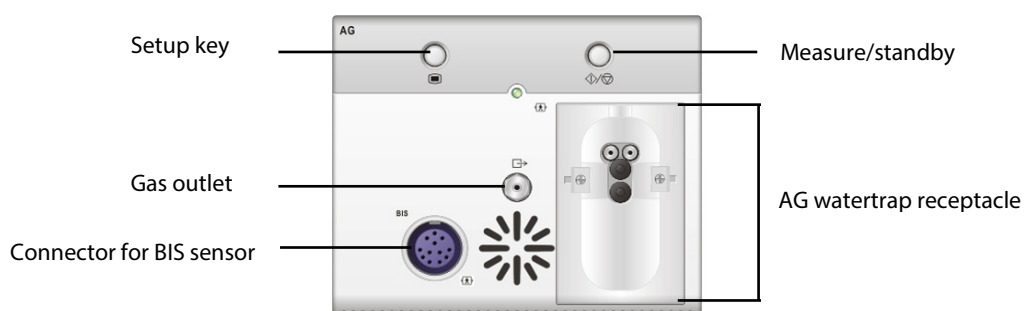

For details on BIS, refer to the chapter **20 Monitoring Bispectral Index (BIS)**.

■ Example of two-slot AG module

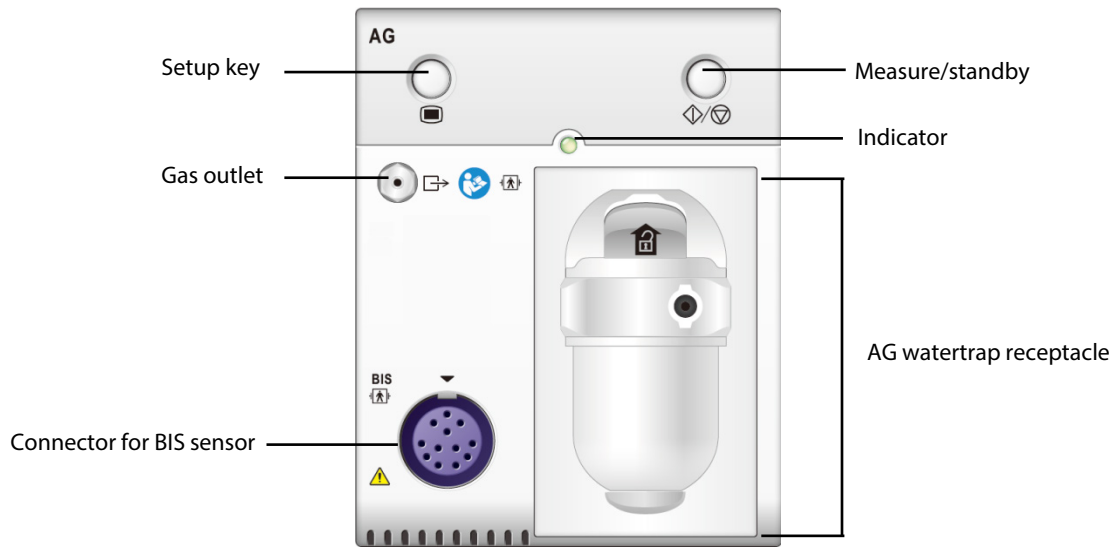

NOTE

- The two-slot AG module is only available for the U.S.

19.3 Understanding the AG Display

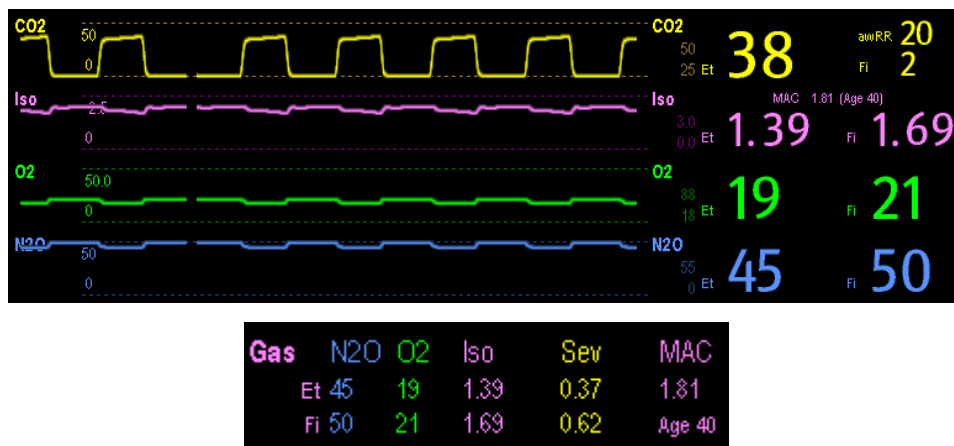

The AG module can send waves and numerics for all measured anesthetic gases for display on the monitor, including:

- CO₂, O₂, N₂O and AA waves
- awRR: airway respiratory rate
- MAC: minimum alveolar concentration
- End tidal (Et) and fraction of inspired (Fi) numerics for CO₂, O₂, N₂O and AA

Where AA represents Des (desflurane), Iso (isoflurane), Enf (enflurane), Sev (sevoflurane), or Hal (halothane).

The AA waveform area displays the primary anesthetic gas's waveform. The O₂ waveform will be displayed only when the O₂ waveform is currently switched on.

WARNING

- To avoid explosion hazard, do not use flammable anesthetic agent such as ether and cyclopropane with this equipment.
-

19.4 MAC Values

Minimum alveolar concentration (MAC) is the minimum concentration of the agent in the alveoli. It is a basic index to indicate the depth of anesthesia. The standard ISO 80601-2-55 defines MAC as this: alveolar concentration of an inhaled anesthetic agent that, in the absence of other anesthetic agents and at equilibrium, prevents 50% of patients from moving in response to a standard surgical stimulus.

Minimum alveolar concentration (MAC) values are listed below:

Agent	Des	Iso	Enf	Sev	Hal	N2O
1 MAC	6%*	1.15%	1.7%	2.1%	0.77%	105%**

* indicates the data is taken from a 25-year-old patient.

** indicates 1 MAC nitrous oxide can only be reached in hyperbaric chamber.

NOTE

- The MAC values shown in the table above are those published by the U.S. Food and Drug Administration for a healthy 40-year-old adult male patient.
 - In actual applications, the MAC value may be affected by age, weight and other factors.
-

The formula to calculate the MAC value is as follows:

$$MAC = \sum_{i=0}^{N-1} \frac{EtAgent_i}{AgentVol_{age}i}$$

Where N is the number of all agents (including N₂O) that the AG module can measure, EtAgent_i is the concentration of each agent, and AgentVol_{age}i is the concentration of each agent at 1 MAC with age correction.

The formula for calculating age correction of 1 MAC is:

$$MAC_{age} = MAC_{40} \times 10^{(-0.00269 \times (age - 40))}$$

For example, the Des concentration at 1 MAC of a 60-year old patient is $6\% \times 10^{(-0.00269 \times (60 - 40))} = 6\% \times 0.88$.

The AG module measures there are 4% of Des, 0.5% of Hal and 50% of N₂O in the patient's end-tidal gas:

$$MAC = \frac{4.0\%}{6\% \times 0.88} + \frac{0.5\%}{0.77\% \times 0.88} + \frac{50\%}{105\% \times 0.88} = 2.04$$

NOTE

- The formula above is only suitable for patients who are older than one year. If the patient is less than one year, the system uses one year to do age correction.
-

19.5 Preparing to Measure AG

To prepare for the AG measurement:

1. Select an appropriate watertrap according to patient category and attach it to the module.
2. Connect the gas sample line to the watertrap connector.
3. Connect the other end of the gas sampling line to the patient via the airway adapter.
4. Connect the gas outlet to a scavenging system using an exhaust tube.

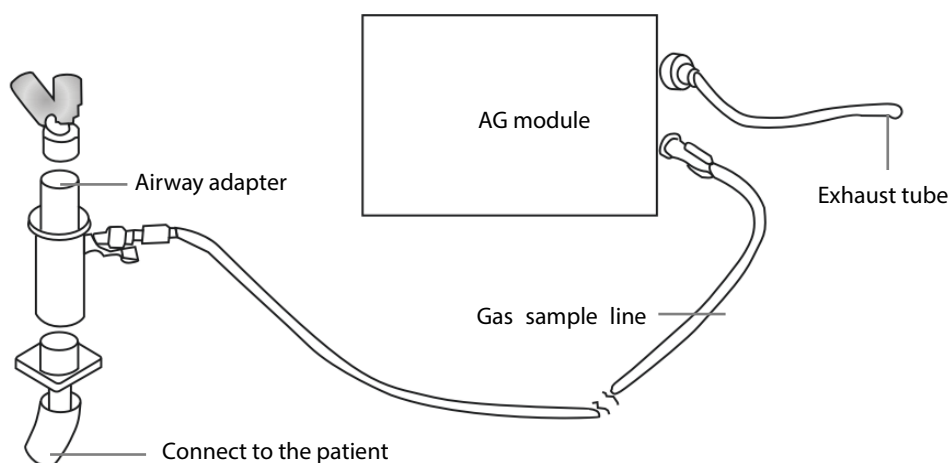

5. Insert the AG module into the SMR or the module rack of the monitor and the monitor will prompt [**AG Startup**]. Then the AG module starts to warmup and at the same time the monitor prompts [**AG Warmup**]. After 45 seconds, the AG module enters the iso accuracy mode. After 10 minutes, the module enters the full accuracy mode.

WARNING

- **Perform the AG leakage test every time before the AG measurement. For instructions on how to perform the leakage test, see 34.7AG Leakage Test.**
 - **Make sure that the connections are tight. Any leak in the system can result in erroneous readings due to ambient air mixing with patient gases.**
 - **Do not apply adult watertrap to the neonate patient. Otherwise, patient injury could result.**
 - **Using high-frequency electrosurgical units may increase the risk of skin burn. In this case, do not use antistatic or conductive respiratory tubing.**
 - **Check that the alarm limit settings are appropriate before taking measurement.**
-

CAUTION

- **Position the airway adapter so that the part connecting to the gas sample line is pointing upwards. This prevents condensed water from passing into the gas sample line and causing an occlusion.**
 - **The watertrap collects water drops condensed in the sampling line and therefore prevents them from entering the module. To avoid blocking the airway, empty the watertrap container whenever half full. Dispose of accumulated fluids in accordance with the hospital policy or your local regulations.**
 - **The watertrap has a filter preventing bacterium, water and secretions from entering the module. After long-term use, dust or other substances may compromise the performance of the filter or even block the airway. In this case, replace the watertrap. Replacing the watertrap once a month is recommended.**
-

19.6 Changing AG Settings

19.6.1 Setting Gas Unit

For N₂O and AA, the unit of the measured gas is fixed to “%”.

To set the gas unit:

1. Select **[Main Menu]**→**[Maintenance >>]**→ **[User Maintenance]** →enter the required password→**[Unit Setup >>]**.
2. In the Unit Setup menu, you can select **[CO₂ Unit]** or **[O₂ Unit]** and then select **[mmHg]**, **[%]** or **[kPa]**.

19.6.2 Setting the Apnea Alarm Delay

To set the apnea alarm delay:

1. Select the AG parameter area to access the **[AG Setup]** menu.
2. Select **[Apnea Delay]** and select the appropriate setting.

The monitor alarms if the patient has stopped breathing for longer than the preset apnea time. The **[Apnea Delay]** setting is universally applied to the Resp, CO₂, AG, and RM modules.

WARNING

- **The respiration measurement does not recognize the cause of apneas. It only indicates an alarm if no breath is detected when a preset time has elapsed since the last detected breath. Therefore, it cannot be used for diagnostic purpose.**
-

19.6.3 Changing the Sample Flow Rate

In the setup menu for any gas, select [**Flow Rate**] and then choose either:

- [**High**]: 200 ml/min for adult and pediatric patients, and 120 ml/min for neonatal patients.
- [**Med**]: 150 ml/min for adult and pediatric patients, and 90 ml/min for neonatal patients.
- [**Low**]: 120 ml/min for adult and pediatric patients, and 70 ml/min for neonatal patients.

19.6.4 Entering the Standby Mode

For the AG module, the default operating mode is measure. When you set the AG module to the Standby mode, the AG gas sample intake pump automatically sets the sample flow rate to zero. When exiting the Standby mode, the AG module continues to work at the previously set sample flow rate with no need to warm up again. After nearly 1 minute, the module enters the full accuracy mode. The Standby mode of the AG module relates to the Standby mode of the monitor as follows:

- If the monitor enters the Standby mode, the AG module also enters the Standby mode.
- If the monitor exits the Standby mode, the AG module also exits the Standby mode.
- If the AG module enters or exits the Standby mode, it does not affect the monitor.

To enter or exit the Standby mode manually, in the agent's setup menu, select [**Operating Mode**] and then select [**Standby**] or [**Measure**]. You can also set a period of time after which the AG module enters the Standby mode automatically if no breath is detected since the last detected breath. To set the Standby time, in the agent's setup menu, select [**Auto Standby (min)**] and then select the appropriate setting.

19.6.5 Setting Up the AG Wave

Select the AG parameter area to access the **[AG Setup]** menu, you can:

- Select **[CO₂ Wave Type]** and then select **[Draw]** or **[Fill]**:
 - ◆ **[Draw]**: The CO₂ wave is displayed as a curved line.
 - ◆ **[Fill]**: The CO₂ wave is displayed as a filled area.
- Select **[Sweep]** and then select the appropriate setting. The faster the wave sweeps, the wider the wave is.
- Change the size of the waveform by adjusting the scale.

19.6.6 Setting RR Source

To set RR source:

1. Select the AG parameter area to access the **[AG Setup]** menu.
2. Select **[RR Source]** and then select a source or **[Auto]** from the dropdown list.

The **[RR Source]** setting is universally applied to the Resp, CO₂, AG and RM modules. For details, refer to section **9.9 Setting Respiration Rate (RR) Source**.

19.7 Changing the Anesthetic Agent

When the anesthetic agent used on the patient is changed, the AG module detects the mixed anesthetic gas during the transition of two anesthetic agents. The time required for completing the replacement of anesthetic agent depends on anesthesia type (low flow or high flow) and the characteristics of anesthetic agents (pharmacokinetics).

The AG module can identify two anesthetic agents automatically. When the proportion of the primary and secondary anesthetic agents in the mixture changes, the AG module can distinguish between them according to their contributions to the MAC value. Then the primary and secondary anesthetic agents will be exchanged for display.

CAUTION

- **During the transition of two anesthetic agents, the monitor gives no prompt messages and the MAC value displayed may be inaccurate.**
-

19.8 Measurement Limitations

The following factors may influence the measurement accuracy:

- Leaks or internal venting of sampled gas
- Mechanical shock
- Cyclic pressure up to 10 kPa (100 cmH₂O)
- Other sources of interference, if any

19.9 Troubleshooting

19.9.1 When the Gas Inlet is Blocked

If the gas inlet (including watertrap, sampling line and airway adapter) is occluded by condensed water, the message **[AG Airway Occluded]** appears.

To remove the occlusion:

- Check the airway adapter for an occlusion and replace if necessary.
- Check the sampling line for an occlusion or kinking and replace if necessary.
- Check the watertrap for a build up of water. Empty the watertrap. If the problem persists, replace the watertrap.

19.9.2 When an Internal Occlusion Occurs

Condensed water may enter the module and cause contamination and/or internal occlusions. In this case, the message **[AG Airway Occluded]** displays.

To remove the occlusion:

- Check for airway adapter for an occlusion and replace if necessary.
- Check the sampling line for an occlusion or kinking and replace if necessary.
- Check the watertrap for a build up of water. Empty the watertrap. If the problem persists, replace the watertrap.

19.10 Removing Exhaust Gases from the System

WARNING

- **Anesthetics: When using the AG measurement on patients who are receiving or have recently received anesthetics, connect the outlet to a scavenging system to avoid exposing medical staff to anesthetics. For the AG module sold in the U.S., you can also connect the outlet to the patient respiration circuit to avoid exposing medical staff to anesthetics.**
-

To remove the sample gas to a scavenging system, connect an exhaust tube to the gas outlet connector of the module.

20 Monitoring Bispectral Index (BIS)

20.1 Introduction

Bispectral index (BIS) monitoring is for use on adult and pediatric patients within a hospital or medial facility providing patient care to monitor the state of the brain by data acquisition of EEG signals.

The BIS, a processed EEG variable, may be used as an aid in monitoring the effects of certain anesthetic agents. Use of BIS monitoring to help guide anesthetic administration may be associated with the reduction of the incidence of awareness with recall during general anesthesia or sedation.

The BISx is for single side BIS monitoring, and the BISx4 is for both single side and bilateral BIS monitoring. The BISx4 applies only when the BIS Bilateral Sensor is connected.

The BISx or BISx4 equipment must be used under the direct supervision of a licensed healthcare practitioner or by personnel trained in its proper use.

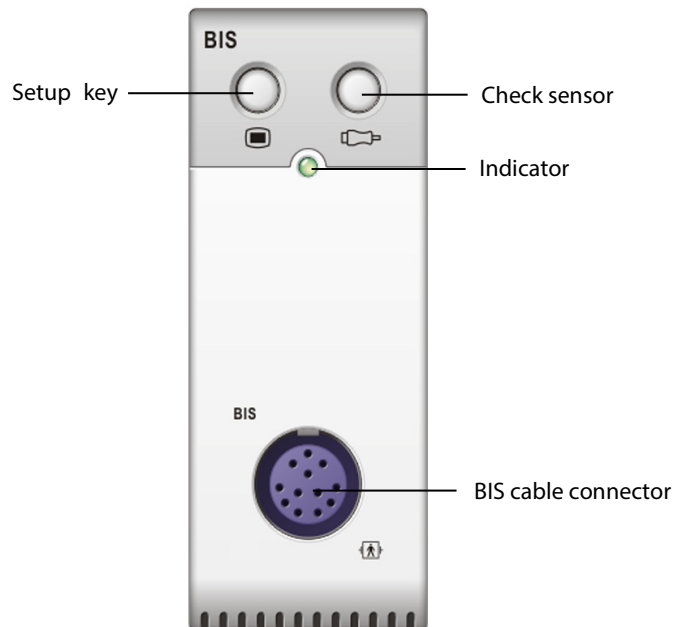

20.2 Safety Information

For patients with neurological disorders, patients taking psychoactive medication, and children below the age of 1 year, BIS values should be interpreted cautiously.

WARNING

- **The conductive parts of sensors and connectors should not come into contact with other conductive parts, including earth.**
 - **To reduce the hazard of burns in the high-frequency surgical neutral electrode connection, the BIS sensor should not be located between the surgical site and the electro-surgical unit return electrode.**
 - **To reduce the hazard of burns during use of brain-stimulating devices (e.g., transcranial electrical motor evoked potential), place stimulating electrodes as far as possible from the BIS sensor and make certain that sensor is placed according to package instructions.**
 - **The BIS sensor must not be located between defibrillator pads when a defibrillator is used on a patient connected to the patient monitor.**
 - **The BIS component using on our monitor is purchased from Covidien. It is important to recognize this index is derived using solely that company's proprietary technology. Therefore, it is recommended that clinicians have reviewed applicable information on its utility and/or risks in published articles and literature/web site information from Covidien, Inc. or contact that company itself at www.covidien.com if you have clinical-based BIS questions relating to this module portion of the patient monitor. Failure to do so could potentially result in the incorrect administration of anesthetic agents and/or other potential complications of anesthesia or sedation. We recommend that clinicians also review the following practice advisory (that includes a section on BIS monitoring): The American Society of Anesthesiologists, Practice Advisory for Intraoperative Awareness and Brain Function Monitoring (Anesthesiology 2006;104:847-64). Clinicians are also recommended to maintain current knowledge of FDA or other federal-based regulatory, practice or research information on BIS and related topics.**
 - **The BIS is a complex technology, intended for use only as an adjunct to clinical judgment and training.**
 - **The clinical utility, risk/benefit and application of the BIS component have not undergone full evaluation in the pediatric population.**
-

20.3 Understanding the BIS Display

20.3.1 BIS Parameter Area

BIS, the primary parameter, always displays in the parameter area. The other parameters are secondary parameters, and display only when configured. See section **20.9 Changing the Secondary Parameters** for the configuration of the secondary parameters.

For single side BIS monitoring, the BIS parameter area displays the following parameters:



1. Bispectral Index (BIS)

The BIS numeric reflects the patient's level of consciousness. It ranges from 100 for wide awake to 0 in the absence of brain activity.

BIS numeric	Description
100	The patient is wide awake.
70	The patient is underdosed but still unlikely to become aware.
60	The patient is under general anesthesia and loses consciousness.
40	The patient is overdosed and in deep hypnosis.
0	The EEG waveform is displayed as a flat line, and the patient has no electrical brain activity.

2. Signal Quality Index (SQI)

The SQI numeric reflects signal quality and provides information about the reliability of the BIS, SEF, TP, and SR numerics during the last minute. Signal quality is optimal when all five bars of the SQI icon are filled with color. SQI ranges from 0-100%.

1 bar represents SQI in the 1%-20% range.

2 bars represent SQI in the 21%-40% range.

3 bars represent SQI in the 41%-60% range.

4 bars represent SQI in the 61%-80% range.

5 bars represent SQI in the 81%-100% range.

- ◆ 0 to 15%: the numerics cannot be derived.
- ◆ 15% to 50%: the numerics cannot be reliably derived.
- ◆ 50% to 100%: the numerics are reliable.

3. Electromyograph (EMG)

EMG bar graph reflects the electrical power of muscle activity and high frequency artifacts. The power range is 30-55 dB. When the EMG indicator is low, it indicates that EMG activity is low. BIS monitoring conditions are optimal when the bar is empty.

1 bar represents power in the 31-35 range.

2 bars represent power in the 36-40 range.

3 bars represent power in the 41-45 range.

4 bars represent power in the 46-50 range.

5 bars represent power greater than 51.

- ◆ EMG > 55 dB: this is an unacceptable EMG.
- ◆ EMG < 55 dB: this is an acceptable EMG.
- ◆ EMG ≤ 30 dB: this is an optimal EMG.

4. Suppression Ratio (SR)

SR numeric is the percentage of time over the last 63-second period during which the EEG is considered to be in a suppressed state.

5. Spectral Edge Frequency (SEF)

The SEF is a frequency below which 95% of the total power is measured.

Other parameters will display if configured:

■ Total Power (TP)

TP numeric, which only monitors the state of the brain, indicates the power in the frequency band 0.5-30Hz. The useful range is 40-100db.

■ Burst Count (BC)

A burst means a period (at least 0.5 second) of EEG activity followed and preceded by inactivity. The BC numeric helps you quantify suppression by measuring the number of EEG bursts per minute. This parameter is intended for the BIS module with the Extend Sensor or Bilateral Sensor only. BC numeric is valid only when SQI ≥ 15% and SR ≥ 5%.

For bilateral BIS monitoring, the BIS parameter area displays the following parameters (L: Left brain hemisphere; R: Right brain hemisphere):

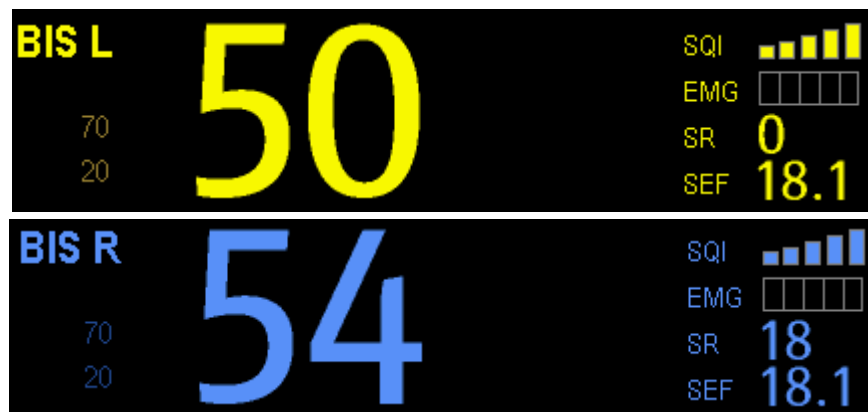

- BIS L BIS R
- EMG L EMG R
- SR L SR R
- SEF L SEF R
- SQI L SQI R
- TP L TP R
- BC L BC R
- sBIS L sBIS R

sBIS (BIS Variability Index)

This numeric represents the standard deviation of the BIS variable over the last three minutes.

- sEMG LsEMG R

sEMG (EMG Variability Index)

This numeric represents the standard deviation of the EMG value over the last three minutes.

- ASYM

Asymmetry (ASYM) is a processed variable indicating the percentage of EEG power present in the left or right hemispheres with respect to total (left and right) EEG power.

Designation 'L' of the asymmetry data indicates asymmetry to the left side.

Designation 'R' of the asymmetry data indicates asymmetry to the right side.

20.3.2 BIS Waveform Area

The BIS waveform area allows you to view either the EEG waveform or the BIS trend. A secondary parameter's trend line can also be displayed together with the BIS trend line.

To view the BIS waveform area:

1. Enter the **[BIS Setup]** menu.
2. Select **[Display]** and then select the desired option.

- ◆ **[EEG]**

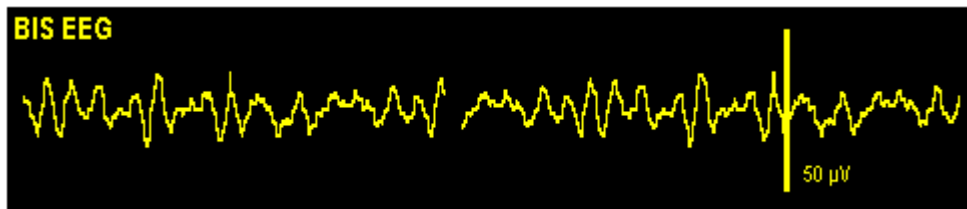

- ◆ **[BIS Trend]**

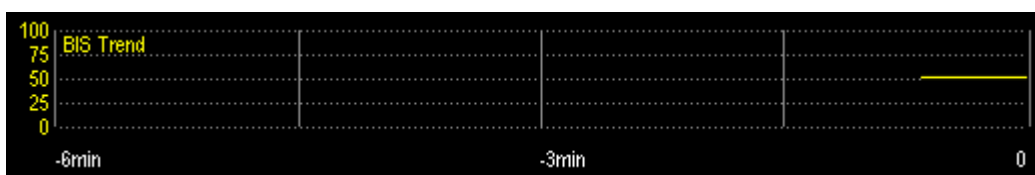

- ◆ The available options for BIS trend superimpose display include: **[BIS+EMG Trend]**, **[BIS+SQI Trend]**, **[BIS+SR Trend]**, **[BIS L+R Trend]**, **[BIS+BC Trend]**, **[BIS+sBIS Trend]** or **[BIS+sEMG Trend]**, depending on the sensor type.

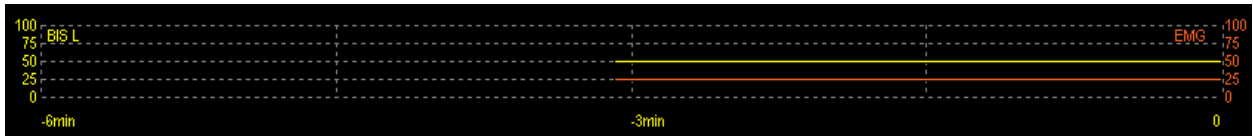

20.3.3 BIS Expand View

When BIS Bilateral Sensor is used for bilateral monitoring, BIS expand view can be displayed.

To view the BIS expanded view:

1. Enter the **[BIS Setup]** menu.
2. Select **[BIS Expand View >>]**.
3. Select **[Display]** and then select **[EEG]**, **[BIS Trend]** or **[DSA]**.

20.3.3.1 Displaying EEG Waveforms

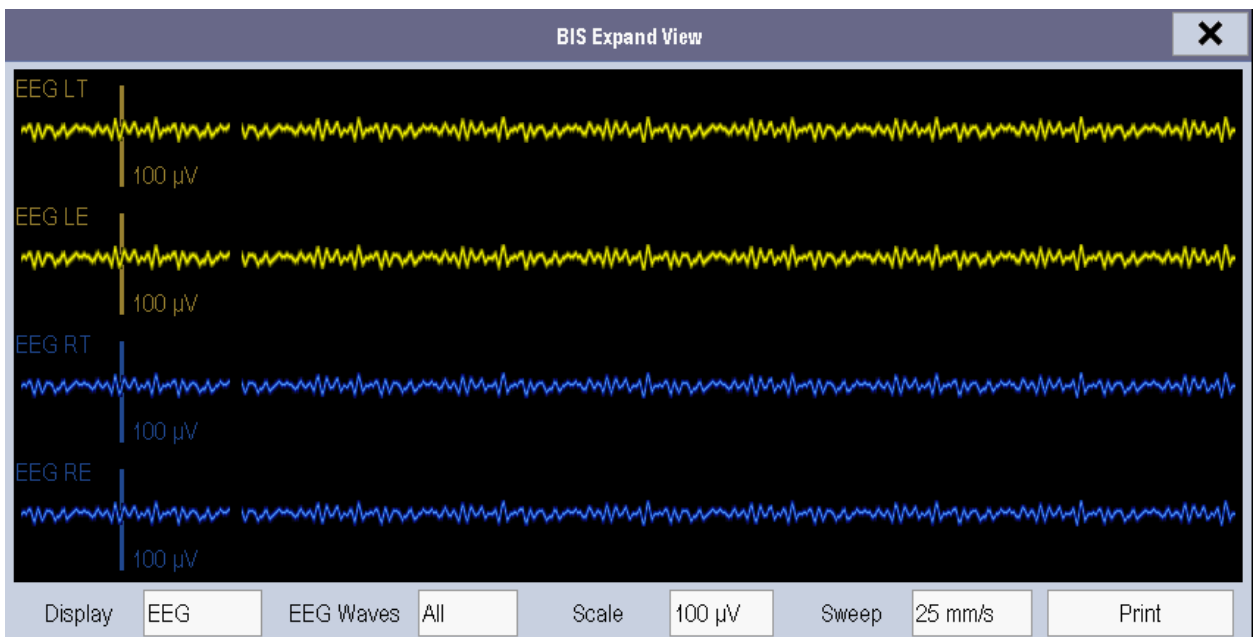

You can select the EEG waveforms to be displayed. You can also set the desired scale and sweep speed by selecting corresponding buttons.

20.3.3.2 Displaying BIS Trend

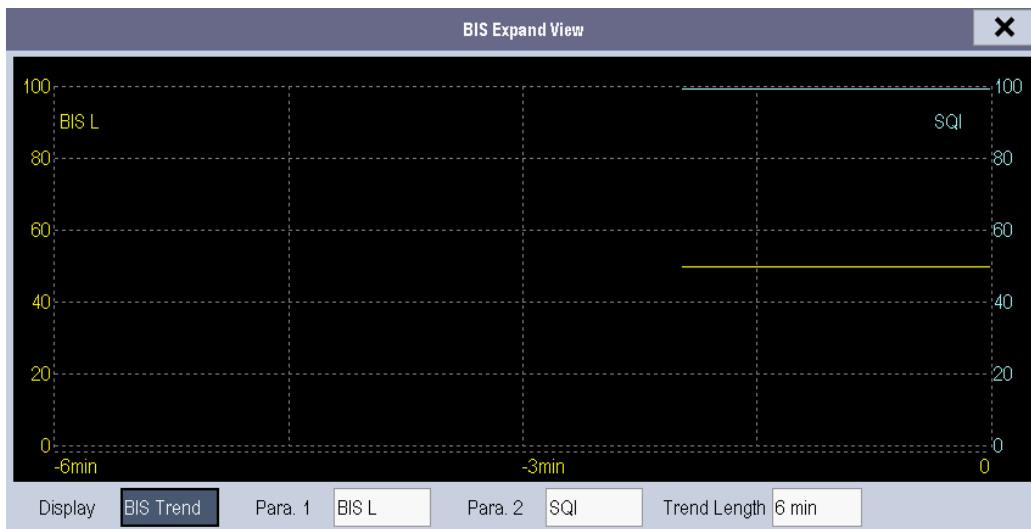

You can select the desired trend lines to be displayed and set the time scale. The artifact mark is displayed at the bottom to indicate SQI value. When $SQI < 15\%$, the artifact mark is yellow and the corresponding trend lines of BIS, SR, BC and sBIS are not displayed. When $15\% \leq SQI < 50\%$, the artifact mark is brown.

20.3.3.3 Displaying Density Spectral Array (DSA)

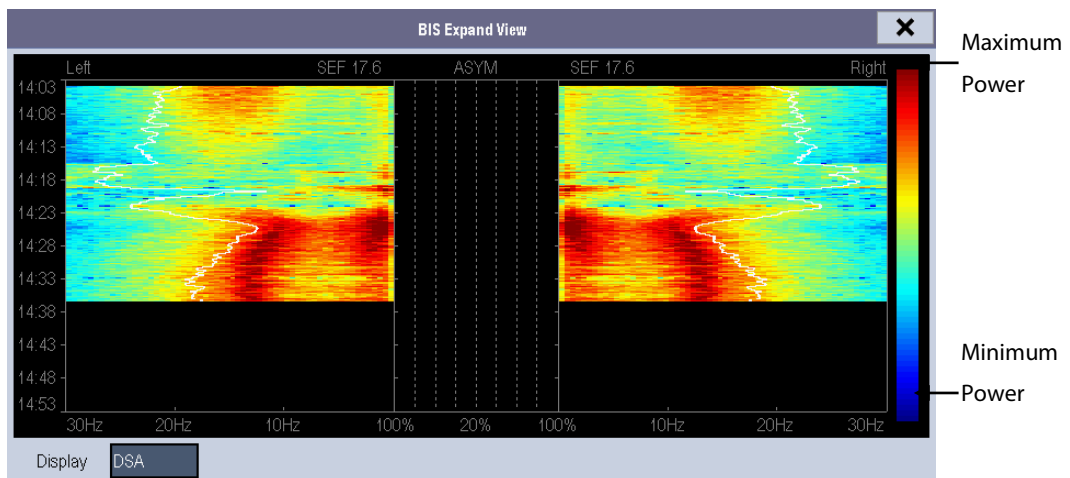

The Density Spectral Array (DSA) shows changes in the power spectrum distribution over a certain time period. The DSA represents the power spectra ranging from 49-94 dB. The color bar to the right of the time scale shows the range of colors used to indicate minimum and maximum power. The frequency scale is shown on the horizontal axis with a range from 0-30 Hz.

A white Spectral Edge line is superimposed on the graph where 95% of the total power lies on one side of the line (toward the inside of the graph) and 5% lies on the other. The Spectral Edge Frequency value (SEF) displays above the graph.

The ASYM graph in the center of the screen shows the degree of asymmetry in EEG power between the left and right hemispheres. The ASYM scale begins at 20% at the center line and runs left or right to 100%. Asymmetry data less than 20% are not displayed on the graph, but are available in the tabular trends.

20.4 Setting up the BIS Measurement

To set up the BIS measurement:

1. Connect the BISx or BISx4 model to the BIS module.

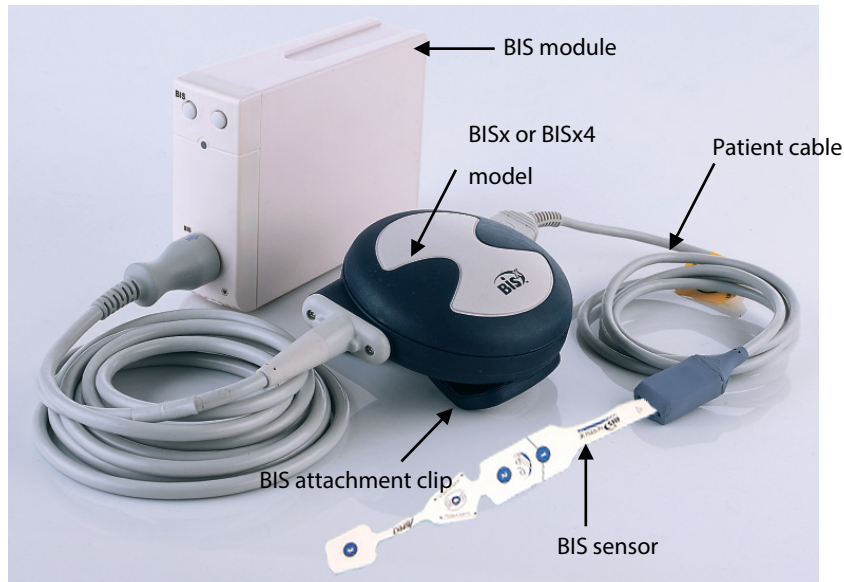

2. Use the attachment clip to secure the BISx or BISx4 model near, but not above the level of the patient's head.
3. Connect the BISx or BISx4 model to the patient cable.
4. Attach the BIS sensor to the patient following the instructions supplied with the sensor.

NOTE

- **Make sure the patient's skin is dry. A wet sensor or a salt bridge could result in erroneous BIS and impedance values.**
-

5. Connect the BIS sensor to the patient interface cable.
-

CAUTION

- **Do not use if sensor is dry. To avoid dry out, do not open pack until ready for use. Due to intimate skin contact, reuse may pose risk of infection. If skin rash or other unusual symptom develops, stop using and remove. Limited to short-term use (maximum of 24 hours). Do not cut sensor components, as this can result in improper operation.**
-

20.5 Auto Impedance Check

Auto impedance checks:

- The combined impedance of the signal electrodes plus the reference electrode. This is done automatically and continuously and does not affect the EEG wave. As long as the impedances are within the valid range, there is no prompt message of this check or its results.
- The impedance of the ground electrode. This is done every ten minutes and takes approximately four seconds. It causes artifact in the EEG wave, and the message **[BIS Ground Checking]** is displayed on the monitor during the check. If the ground electrode does not pass this check, another check is initiated. This continues until the ground electrode passes the check.

By default, auto impedance is switched on. If the auto impedance check interferes with other measurements, it can be switched off.

To switch the function off:



1. Select **[Sensor Check]** in the **[BIS Setup]** menu to open the sensor check window.
2. Set **[Automatic Check]** to **[Off]**.

CAUTION

- **Switching the auto impedance check off will disable automatic prompt to the user of impedance value changes, which may lead to incorrect BIS values. Therefore, this should only be done if the check interferes with or disturbs other measurements.**
-

20.6 Sensor Check

Sensor check measures the exact impedance of each individual electrode. It causes a disturbed EEG wave, and a prompt message is displayed on the monitor.

- The sensor check is automatically initiated when a sensor is connected. To manually start a sensor check, you can either:
 - ◆ Press the  hardkey on the BIS module.
 - ◆ Select **[Sensor Check]** in the **[BIS Setup]** menu.
 - ◆ Select **[Start Sensor Check]** in the BIS sensor window.
- The sensor check stops automatically if the impedances of all electrodes are within the valid range. To manually stop a sensor check, you can either:
 - ◆ Press the  hardkey on the BIS module.
 - ◆ Select **[Stop Sensor Check]** in the sensor check window.

20.7 BIS Sensor Check Window

To open the sensor check window, select **[Sensor Check]** in the **[BIS Setup]** menu. The graphic in the BIS sensor check window automatically adapts to show the type of sensor you are using, show each electrode as required. Each symbol in the graphic represents an electrode and illustrates the most recently-measured impedance status of the electrodes.

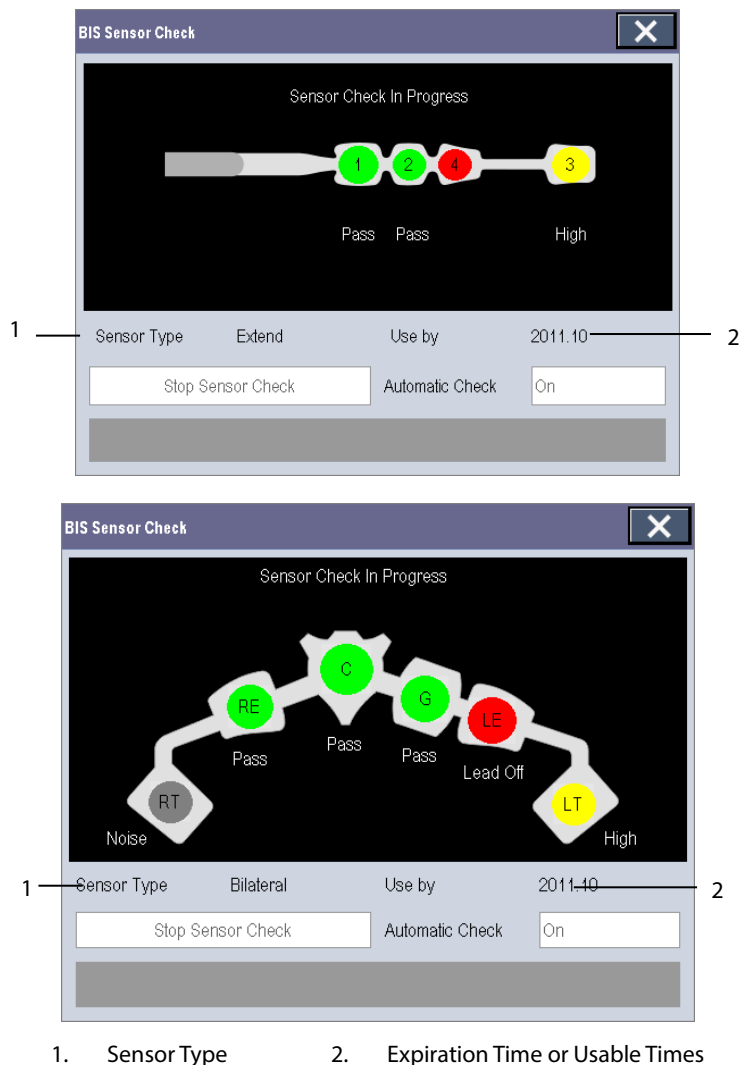

Different colors indicate different statuses. The electrode status is displayed below each electrode:

Color	Status	Description	Action
Red	[Lead Off]	The Electrode fell off and has no skin contact.	Reconnect electrode, or check the sensor-to-skin contact. If necessary, clean and dry skin.
Grey	[Noise]	The EEG signal is too noisy. Impedance cannot be measured.	Check the sensor-to-skin contact. If necessary, clean and dry skin.
Yellow	[High]	The impedance is above the limit.	
Green	[Pass]	The impedance is within valid range.	No action necessary.

Although BIS may still be measured when the electrode status is **[Noise]** or **[High]**, for best performance, all electrodes should be in **[Pass]** status.

20.8 Choosing the BIS Smoothing Rate

The smoothing rate defines how the monitor averages the BIS value. With the smoothing rate becoming smaller, the monitor provides increased response to changes in the patient's state. Contrarily, the monitor provides a smoother BIS trend with decreased variability and sensitivity to artifacts.

To change the smoothing rate:

1. Select the BIS parameter window to enter the **[BIS Setup]** menu.
2. Select **[Smoothing Rate]** and then select **[10 s]**, **[15 s]** or **[30 s]**.

NOTE

-
- When **[Smoothing Rate]** is set as **[10 s]** or **[30 s]**, **sBIS** and **sEMG** are displayed as invalid values.
-

20.9 Changing the Secondary Parameters

To choose the desired secondary parameters for display on the screen:

1. Enter the **[BIS Setup]** menu.
2. Select **[Change Secondary Parameter>>]** and then select a maximum of 2 parameters from the pop-up menu.

20.10 Changing the EEG Wave Size

To change the EEG wave size:

1. Enter the **[BIS Setup]** menu.
2. Select **[EEG]** from **[Display]**.
3. Select **[Scale]** and then select the appropriate setting.

20.11 Changing the Speed of the EEG Wave

To change the speed of the EEG wave:

1. Enter the **[BIS Setup]** menu.
2. Select **[EEG]** from **[Display]**.
3. Select **[Sweep]** and then select the appropriate setting. The faster the wave sweeps, the wider the wave is.

20.12 Setting the Trend Length

To set the trend length:

1. Enter the **[BIS Setup]** menu.
2. Select a BIS trend option from **[Display]**.
3. Select **[Trend Length]** and then select the appropriate BIS time length setting.

20.13 Switching the Filter On or Off

To switch the filter on or off:

1. Enter the **[BIS Setup]** menu.
2. Select **[Filter]** and then select **[On]** or **[Off]**. The default is **[On]**.

The filter screens out undesirable interference from the raw EEG wave display. The notch filter includes filters for both 50 and 60 Hz. Filter settings do not affect processing of the trend variables (i.e., BIS, EMG, and SR).

20.14 Covidien Information

■ Covidien Patents

This posting serves as notice under 35 U.S.C. § 287(a) for Covidien patents: <http://www.covidien.com/patents>.

■ No Implied License

Possession or purchase of this device does not convey any express or implied license to use the device with unauthorized replacement parts or consumables which would, alone, or in combination with this device, fall within the scope of one or more of the patents relating to this device.

21 Monitoring NMT (From TOF-Watch® SX Monitor)

21.1 Introduction

This monitor can connect an Organon TOF-Watch® SX monitor for NMT (neuromuscular transmission) monitoring. This monitor can display, store and review measurements from TOF-Watch® SX monitor, as well as present related alarms. On this patient monitor, you can separately set the level of NMT related alarms and switch on or off alarm recording; you can also view TOF-Watch® SX monitor settings of alarm limits and alarm switch.

21.2 Safety

WARNING

- **TOF-Watch® SX monitor is manufactured by Organon. This company provides the technology for measuring NMT parameters. We only provide the connection between this patient monitor and TOF-Watch® SX monitor.**
 - **If you have any doubts about the operation and maintenance of the TOF-Watch® SX monitor, please refer to TOF-Watch® SX monitor operator's manual or directly contact Organon.**
 - **Fully observe TOF-Watch® SX monitor operator's manual to make settings and to connect the monitor with a patient.**
-

21.3 Connecting a TOF-Watch® SX monitor

The TOF-Watch® SX monitor connects with BeneLink module through an ID adapter. For how to establish connection between the TCM monitor and the BeneLink module, refer to ***BeneLink Module Operator's Manual (PN: 046-011948-00)***.

21.4 NMT Parameters

TOF-Watch® SX monitor provides the following measurements:

- TOF-Ratio
- TOF-Count
- PTC
- Single
- Tskin

21.5 Accessing the NMT Setup menu

You can access the [+NMT Setup] menu by selecting the NMT area or selecting [Main Menu] → [Parameters >>] →

[+NMT Setup>>]. In the [+NMT Setup] menu, you can

- Toggle [Alarm Sound] between [On] and [Off] to switch on or off NMT alarms on this patient monitor.
- View the setup as follows:
 - ◆ Stimulation Current
 - ◆ Stimulation Charge
 - ◆ Pulse Width
 - ◆ TOFs Interval
 - ◆ Transducer Sensitivity
- Set alarm level for TOF-Ratio and TOF-Count, switch on or off alarm record.

21.6 NMT Display

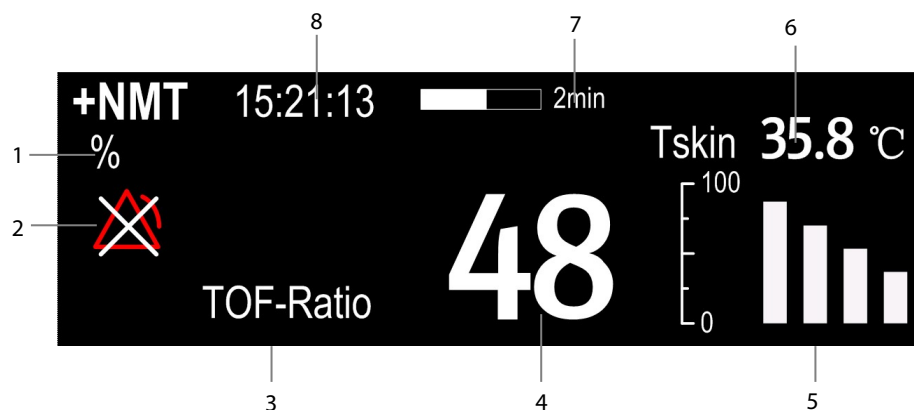

1. Parameter unit
2. Alarm status
3. Parameter label
4. Parameter measurement
5. Response amplitude of stimulation
6. Skin temperature
7. Measurement countdown
8. Time of last measurement

In the case that you take a measurement in TET50Hz mode, TET100Hz mode, DBS3.3 mode or DBS3.2 mode, only mode label is displayed in the NMT parameter area, which is shown as follows:



Measuring mode

FOR YOUR NOTES

22 Monitoring Respiratory Mechanics (RM)

22.1 Introduction

WARNING

- **RM monitoring is not intended for neonatal patients.**
-

The RM monitoring enables clinicians to understand the ventilator operation and patient respiratory status. In the respiratory mechanics (RM) measurement, the airway pressures are measured, from the part between the patient circuit and intubation tube, using a flow sensor between the Y-piece of patient circuit and the patient connection. The pressure is transferred to the monitor through the tube and measured by a pressure transducer in the RM module. The pressure difference together with the gas concentration information is used to calculate flow. The volume information is obtained by integrating the flow signal. From these three parameters, other parameters such as RR, I:E, Compl, etc. are derived.

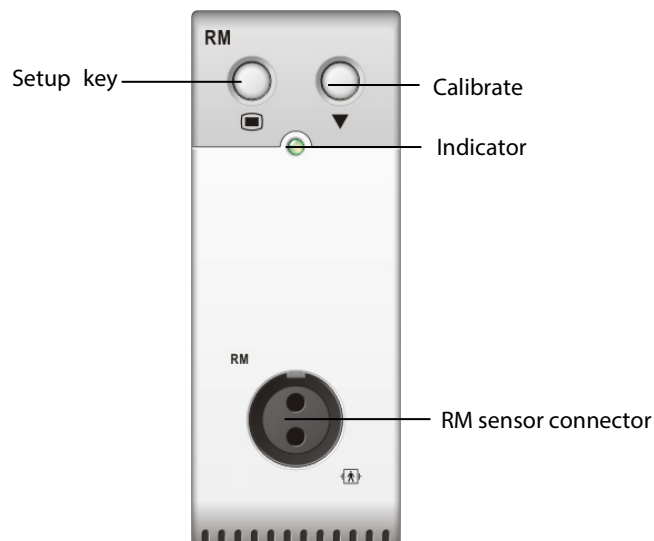

RM monitoring displays the following waveforms and loops:

- Flow waveform
- Paw waveform
- Vol waveform
- FV (flow-volume) loop
- PV (paw-volume) loop

RM monitoring provides values for 15 parameters. The 15 parameters can be classified into 4 categories:

1. Paw parameters (not applicable for patients with spontaneous breath)

- ◆ PIP: peak inspiratory pressure (unit: cmH₂O)
- ◆ Pplat: pressure (unit:cmH₂O)
- ◆ PEEP: positive end expiratory pressure (unit: cmH₂O)
- ◆ Pmean: mean pressure (unit: cmH₂O)

2. Flow parameters

- ◆ PIF: peak inspiratory flow (unit: L/min)
- ◆ PEF: peak expiratory flow (unit: L/min)

3. Vol parameters

- ◆ TVi: inspiratory tidal volume (unit: ml)
- ◆ TVe: expiratory tidal volume (unit: ml)
- ◆ MVi: inspiratory minute volume (L)
- ◆ MVe: expiratory minute volume (L)

4. Other parameters

- ◆ RR: respiratory rate (unit: rpm)
- ◆ I: E: ratio of the inspiratory and expiratory time
- ◆ Compl: compliance (unit: ml/cmH₂O)
- ◆ FEV1.0: first second forced expiratory volume ratio (unit: %)
- ◆ RSBI: rapid shallow breathing index (unit: rpm/L)

22.2 Safety Information

WARNING

- **Check for leaks in the breathing circuit system, as they may significantly affect respiratory mechanics readings.**
 - **Match the airway adapter you select to the appropriate patient category. Improper sensor selection may produce excessive ventilation resistance or introduce excessive airway dead space, and inaccurate scales and alarm limits.**
 - **Periodically check the flow sensor and tubing for excessive moisture or secretion build-up and purge if necessary.**
-
-

NOTE

- To avoid the affects of excessive moisture in the measurement circuit, insert the flow sensor airway adapter in the breathing circuit with the tubes upright.
- Do not place the airway adapter between the endotracheal tube and an elbow as this may allow patient secretions to block the adapter windows.
- Measurement values provided by a ventilator may differ significantly from the values provided by the RM module, due to different locations of the flow sensor.
- It is recommended to put a heat moisture exchanger between the ventilator and the flow sensor.
- It is recommended to position the connector of flow sensor lower than the pressure sampling line.
- Keep the respiration loop away from condensing equipment.
- Set the ventilator according to the specified range of the RM module. Or unexpected alarm or inaccurate measurement could result.

22.3 Preparing to Monitor RM

To prepare to monitor RM:

1. Select an appropriate flow sensor in accordance with the patient category.
2. Connect the small tubes of the flow sensor to the RM connector of the module using a color-coded adapter.
3. Insert the flow sensor between the Y-piece of the patient circuit and the patient connection.

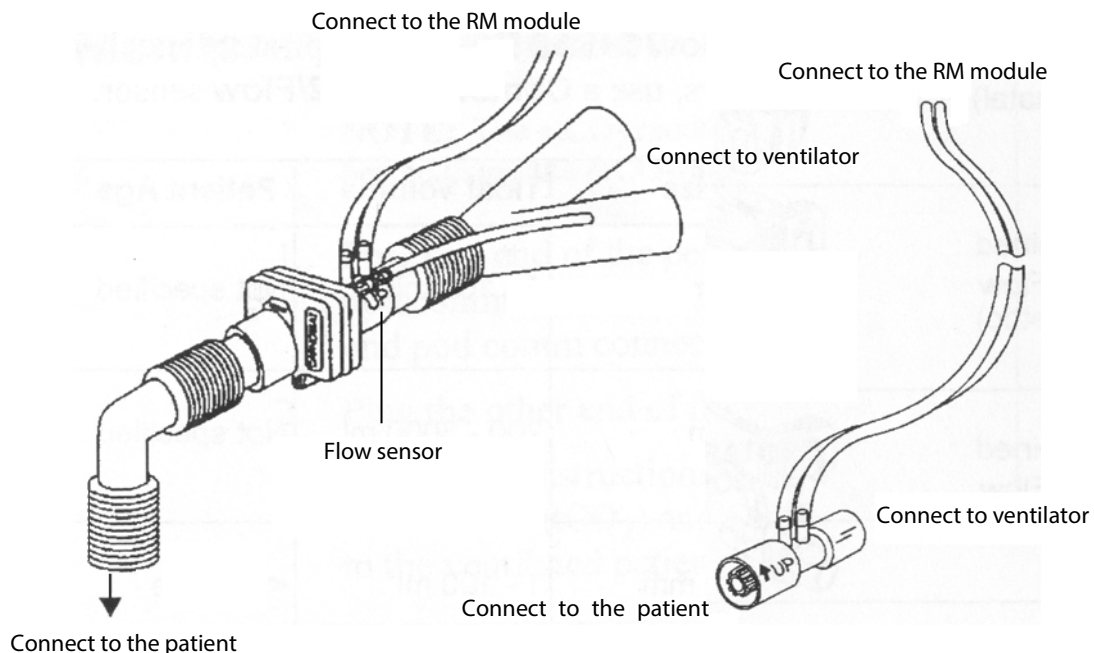

4. Calibrate the flow sensor according to the procedure described in section **22.8 Calibrating the Flow Sensor**.
5. Select **[Sensor Type]** in the **[Calibrate RM]** menu and then choose **[Infant One-time]**, **[Disposable]** or **[Reusable]** according to the selected sensor.

22.4 Understanding the RM Display

The RM display shows either the Paw and Flow waveforms, or the Paw and Vol windows in the waveform area.

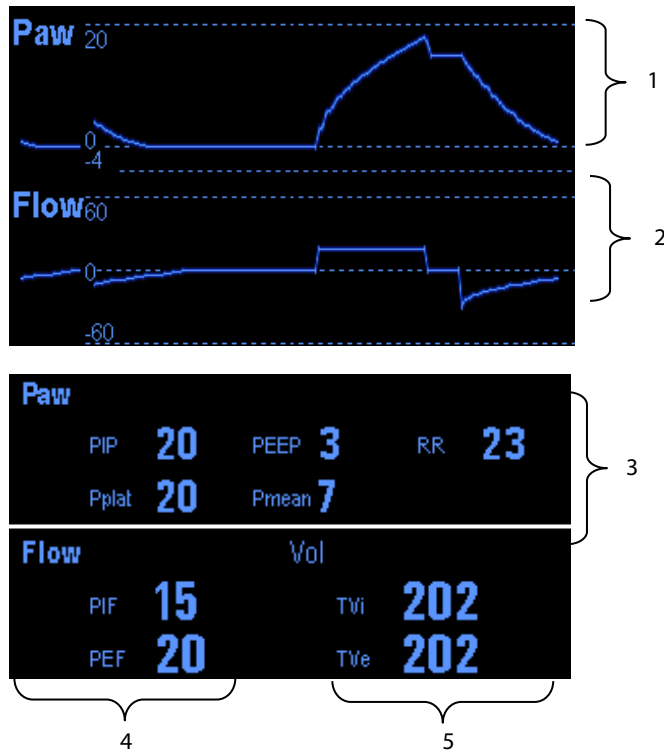

1. Paw waveform
2. Flow waveform
3. Paw parameter window
4. Flow parameter window
5. Vol parameter window

22.5 Changing RM Settings

22.5.1 Accessing RM Menus

To access the RM menus:

- Select the RM parameter window or waveform area to can access the **[RM Setup]** menu.
- Select the Paw wave to access the **[Paw Waveform]** menu.
- Select the Flow wave to access the **[Flow Waveform]** menu.
- Select the Vol wave to access the **[Vol Waveform]** menu.

22.5.2 Setting the Apnea Alarm Delay

To set the apnea alarm delay:

1. Select the RM parameter window or waveform area to access the **[RM Setup]** menu.
2. Select **[Apnea Delay]** and then select the appropriate setting. The monitor will alarm if the patient has stopped breathing for longer than the previously set apnea time.

The **[Apnea Delay]** setting takes effect simultaneously to the Resp, CO₂, AG, and RM modules.

WARNING

- **The respiration measurement does not recognize the cause of apneas. It only indicates an alarm if no breath is detected when a pre-adjusted time has elapsed since the last detected breath. Therefore, it cannot be used for diagnostic purposes.**
-

22.5.3 Selecting TV or MV for Display

To select tidal volume (TV) or minute volume (MV) for display in the Vol parameter window:

1. Select the RM parameter window or waveform area to access the **[RM Setup]** menu.
2. Select **[TV/MV]** and then select **[TV]** or **[MV]**.

By default, the Vol parameter window displays TV values.

22.5.4 Selecting Flow or Vol Waveform for Display

To select Flow or Vol waveform for display:

1. Select the RM parameter window or waveform area to access the **[RM Setup]** menu.
2. Select **[Flow/Vol]** and then select **[Flow]** or **[Vol]**.

22.5.5 Changing the Wave Sweep Speed

To change the sweep speed:

1. Select the RM parameter window or waveform area to access the **[RM Setup]** menu.
2. Select **[Sweep]** and select the appropriate setting. The faster the wave sweeps, the wider the wave is.

22.5.6 Changing the Wave Scale

To change the wave scale:

1. Select the RM parameter window or waveform area to access the **[RM Setup]** menu.
2. In the **[RM Setup]** menu, select **[Wave Scale >>]**.
3. Select the appropriate settings in the pop-up menu.

22.5.7 Setting RR Source

To set the RR (respiration rate) source:

1. Select the RM parameter window or waveform area to access the **[RM Setup]** menu.
2. Select **[RR Source]** and then select a source or **[Auto]** from the dropdown list.

The **[RR Source]** setting takes effect simultaneously to the Resp, CO₂, AG and RM modules. For details, please refer to section **9.9 Setting Respiration Rate (RR) Source**.

22.6 Understanding the Respiratory Loops

Select **[Respiratory Loop]** in the **[RM Setup]** menu. The following window will be displayed.

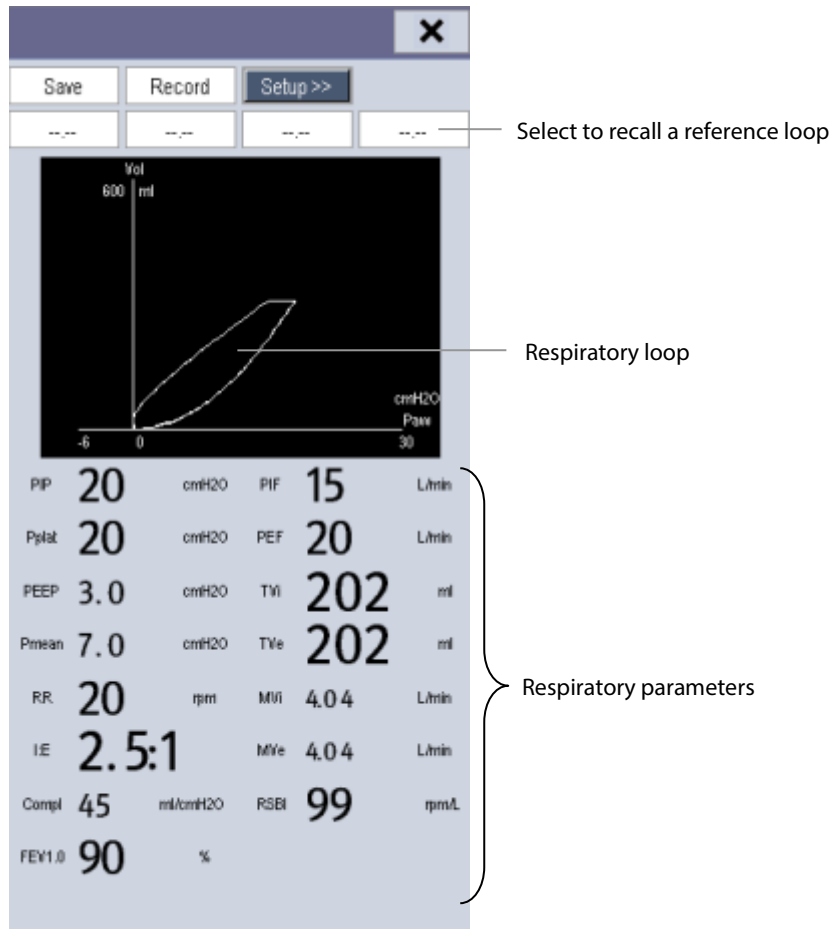

In this window, you can:

- Select [**Save**] to save the respiratory loops in the current respiratory cycle as the reference loops. Up to 4 groups of respiratory loops can be saved, and the saving time is displayed above the respiratory loops.
- Change the respiratory loops displayed on the screen: select [**Setup >>**]→[**Display Loop**] and then select [**PV Loop**] or [**FV Loop**].
- Turn on/off reference loop: select [**Setup >>**]→[**Reference Loop**], and then select [**On**] or [**Off**].
- Change the size of the PV and FV loops: select [**Setup >>**], and then adjust the [**Paw Scale**], [**Vol Scale**] or [**Flow Scale**].
- Select parameters for display: select [**Setup >>**]→[**Select RM Parameters >>**], and then select [**All RM Parameters**] or [**Select Desired RM Parameters**]. When you select [**Select Desired RM Parameters**], 6 parameters at maximum can be selected.
- Print out all parameters for a reference loop by selecting your desired reference loop and then selecting [**Record**].

22.7 Zeroing the RM Module

A zero calibration is carried out automatically every time the monitor is switched on or the RM module connected, and then a zero calibration will automatically be triggered every 5 minutes. You can also start a manual zero calibration when there is a drift in the zero: in the [**RM Setup**] menu, select [**Zero RM**].

22.8 Calibrating the Flow Sensor

A calibration must be performed every time the RM module is connected to the monitor or the flow sensor is connected. To calibrate the flow sensor:

1. When calibration is needed, the [**Calibrate RM**] menu pops up automatically. You can also enter the [**Calibrate RM**] menu by selecting [**Calibrate RM >>**] from the [**RM Setup**] menu.
2. Select [**Sensor Type**] and then choose [**Infant One-time**], [**Disposable**] or [**Reusable**] according to the sensor used.
3. Enter the positive and negative factor provided on the flow sensor and select [**Calibrate**].
4. After the calibration is completed successfully, the last calibration time and the message [**Calibration Completed!**] are displayed. Otherwise, the message [**Calibration Failed!**] is displayed.

FOR YOUR NOTES

23 Monitoring NMT (from Mindray NMT Module)

23.1 Introduction

The neuromuscular transmission (NMT) module evaluates muscle relaxation of patients under neuromuscular block by measuring the strength of muscle reaction after electrically stimulating the dedicated motor nerve. The electrodes are placed on the patient's skin over dedicated nerve, a controllable current source delivers stimulation pulses to two skin surface electrodes for the nerve stimulation, and the muscle response is measured with an acceleration sensor.

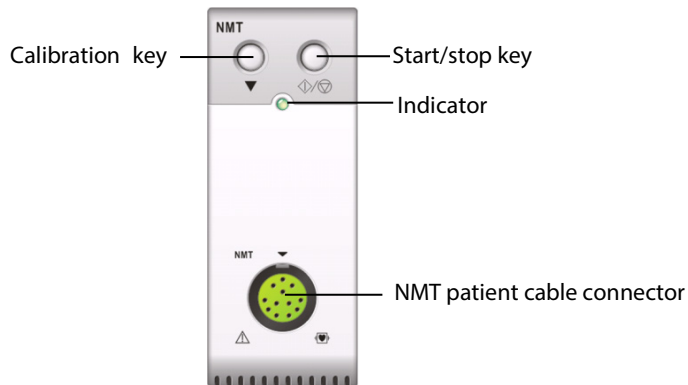

NOTE

- The NMT module is only available for the U.S.
-

23.2 Safety

WARNING

- The NMT measurement is not intended for neonatal patients.
 - The NMT stimulation should not be applied across or through the head, directly on the eyes, covering the mouth, on the front of the neck, especially the carotid sinus, or from electrodes placed on the chest and the upper back or cross over the heart.
 - Application of electrodes near the thorax may increase the risk of cardiac fibrillation.
 - Never apply electrodes to patients in areas where inflammation or injury is evident.
 - When you are connecting the electrodes or the patient cable, make sure that the connectors do not touch any electrically conductive material including earth.
 - Patients with nerve damage or other neuromuscular problems may not respond properly to stimulation. The NMT measurement may show unusual patterns when monitoring muscle paralysis in these patients.
 - NMT stimulation current pulses may interfere with other sensitive equipment, for example, implanted cardiac pacemakers. Do not use the NMT measurement on patients with implanted medical devices unless so directed by a medical specialist.
 - Simultaneous use of the NMT with high frequency electrosurgical equipment (ESU) may result in burns at the stimulation site and can also adversely affect measurement accuracy. Make sure the ESU return electrode is properly applied to the patient.
 - Do not use the NMT in close proximity to shortwave or microtherapy devices, there is a risk of adversely
-

 **WARNING**

affecting the NMT measurement.

- **Never touch the electrodes unless the stimulation has been stopped.**
 - **Check each time before use that the material insulating the NMT sensor and the stimulation cable is intact and does not show signs of wear and tear.**
 - **Do not use in the presence of flammable anesthetics or gases, such as a flammable anesthetic mixture with air, oxygen or nitrous oxide. Use of the device in such an environment may present an explosion hazard.**
-

 **CAUTION**

- **NMT monitoring is intended as an adjunct in patient assessment and must be used in conjunction with observation of clinical signs and symptoms.**
 - **NMT stimulation can be painful to a non-sedated patient. It is recommended not to stimulate before the patient is adequately sedated.**
 - **Pay special attention to current densities exceeding 2 mA r.m.s/cm² for any electrodes.**
 - **It is recommended to use small electrodes in order to obtain a sufficient current density. The diameter of the conductive hydrogel should be 1 inches or less. In order to ensure the quality of the NMT test, be sure only to use stimulation electrodes authorized by FDA.**
-

23.3 Stimulation Modes

The NMT module provides the following stimulation modes. Some stimulation modes require a minimum neurophysiological recovery time and during this recovery phase no new stimulation can be started. So you cannot start a measurement or calibration.

23.3.1 Train-Of-Four (TOF)

TOF mode is recommended for most cases. It is also the factory default setting.

In Train of Four stimulus mode, four stimulation pulses are generated at 0.5 second intervals. Each stimulation of the train causes the muscle to contract. The fade in the individual response to each single stimulation provides a basis for evaluation. The response is measured after each stimulus and the ratio of the fourth to the first response of the TOF sequence is calculated resulting in TOF-Ratio.

When relaxation deepens, the TOF% declines until the fourth response disappears and no TOF% is calculated.

When no TOF% is available, the degree of neuromuscular block is estimated from the number of responses or TOF Counts. The fewer the response count is detected, the deeper is the relaxation.

If NMT calibration establishes the reference response amplitude, response to the first stimulus (T1) as percentage of the reference value is calculated resulting in T1%.

In TOF mode, the minimum neurophysiological recovery time is 10 seconds. If NMT measurement or calibration is initiated during this period, it will be automatically delayed.

23.3.2 Single Twitch (ST)

In single twitch (ST) stimulation, the module sends a single electrical pulse and measures the strength of the resulting twitch, the module then calculates the ratio of measured response to the reference twitch resulting in ST-Ratio.

ST mode is practical when using depolarizing relaxants since TOF% does not give any additional information about the patient status. Additionally, when the change of patient's relaxation level is considered, ST stimulation at a frequency of 1 Hz can indicate the relaxation change in a more real-time way.

23.3.3 Post-Tetanic Count (PTC)

When neuromuscular block deepens, different parameters are needed to measure the response. At first, when the response to the fourth TOF stimulation pulse disappears or the first twitch is very weak, the TOF% is not available and only the number of detected counts can be observed. When stimulation pulses no longer give any stimulation response, you do not get the TOF count either. To monitor the relaxation level, you can start tetanic stimulation and estimate the relaxation level from the Post Tetanic Count (PTC).

PTC stimulation mode starts with a sequence of four current pulses delivered at 2 Hz. If a muscle response is detected, the PTC sequence is stopped and the TOF result is reported. If there is no muscle response, the sequence continues with a five seconds long tetanic stimulation delivered at 50 Hz, followed by a pause of 3 seconds, followed by 20 single current pulses delivered at 1 Hz. The number of detected responses is counted and expressed as PTC. The fewer responses are detected, the deeper is the relaxation.

After tetanic stimulation, NMT measurements and calibration are disabled for 20 seconds and PTC is disabled for 2 minutes.

23.3.4 Double-Burst Stimulation (DBS)

Double Burst Stimulation (DBS) enables better visual observing of the fading in the responses. DBS consists of two separate bursts at an interval of 750 ms, where each burst consists of certain pulses directly after each other at a frequency of 50 Hz. The response ratio of the second to the first burst is calculated resulting in DBS-Ratio, while the number of responses is detected and expressed as DBS Count.

The module supports DBS 3.2 and DBS 3.3. For DBS3.2 mode, the first burst consists of 3 consecutive pulses, and the second burst consists of 2 consecutive pulses. For DBS3.3 mode, both bursts consist of 3 consecutive pulses.

In DBS mode, the minimum neurophysiological recovery time is 15 seconds. If NMT measurement or calibration is initiated during this period, it will be automatically delayed.

23.4 Preparing for NMT Measurement

To take NMT measurement, connect the NMT patient cable to the NMT module. The following picture shows NMT cable and patient connection.

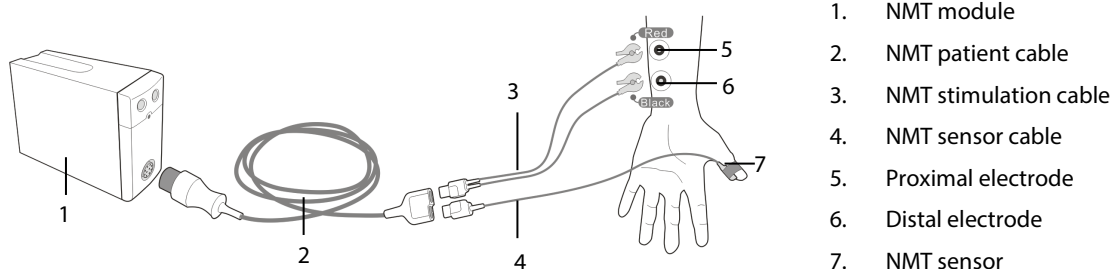

23.4.1 Skin Preparation

Good electrode-to-skin contact is important for good signal quality. Before applying the electrodes, clean the application site of oil and dirt and avoid placing the electrodes over excessive body hair or lesions. Insufficient cleaning of the skin can cause high skin impedance which could cause the stimulation to stop.

To properly prepare the skin:

1. Select sites with intact skin, without lesion of any kind.
2. Clip or shave hair from application sites as necessary.
3. Thoroughly clean the sites with mild soap and water, leaving no soap residue.
We do not recommend using ether or pure alcohol because this dries the skin and increases the impedance.
4. Dry the skin thoroughly.

WARNING

- **The NMT measurement is not intended for neonatal patients.**
-
-

23.4.2 Placing the Electrodes and Sensor

Stimulation of the ulnar nerve in the wrist and acceleration measurements at the adductor pollicis is preferred for routine monitoring.

When monitoring neuromuscular transmission, round surface electrodes with snap connection are a must. Small (pediatric or neonatal) electrodes are advisable to obtain a sufficient current density. In order to ensure a steady signal quality, be sure only to use CE marked electrodes.

Ensure that the thumb can move freely before applying NMT electrodes and sensor. Follow this procedure to place the electrodes and sensor.

1. Place the distal electrode near the wrist.
2. Place the proximal electrode 2 to 3 cm proximal of the distal electrode.
3. Attach the red cable clamp cable to the proximal electrode.
4. Attach the black cable clamp cable to the distal electrode.
5. Affix the sensor with its large flat side against the palmar side of the thumb with a piece of tape. The cable should be attached in such a way that it does not 'pull' at the sensor and that movement of the thumb is not obstructed.

The arm used for the NMT measurement should be kept immobile during the whole procedure.

 **CAUTION**

- To avoid unintentional electrical shocks always make sure that the NMT stimulation has been stopped before touching the electrodes.
 - Take care to handle the the NMT sensor, avoiding forcefully striking the sensor.
 - After repositioning the patient, check that the sensor is still applied and that the thumb can move freely.
-

NOTE

- Correct positioning of the electrodes is important. Small displacements may result in considerable changes in stimulation current requirements. Furthermore, the electrodes must be positioned in such a way to avoid direct stimulation of the muscle.
 - The electrodes should be applied properly to the patient skin. It has been found that slight pressure on the electrodes may improve the stimulation considerably. Therefore, taping the electrodes to the skin may be advisable.
 - The more distal the sensor is placed on the thumb, the stronger the acceleration signal. This effect can be used to adjust the signal strength.
-

23.5 Accessing the NMT Setup Menu

You can access the [NMT Setup] menu by selecting the NMT area.

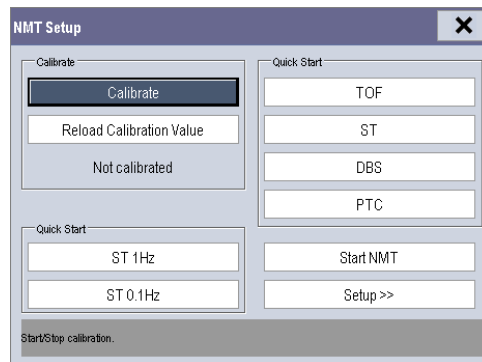

The [NMT Setup] menu enables you to perform calibration, and provides quick start to NMT measurements. You can also access the following menu by selecting [Setup >>].

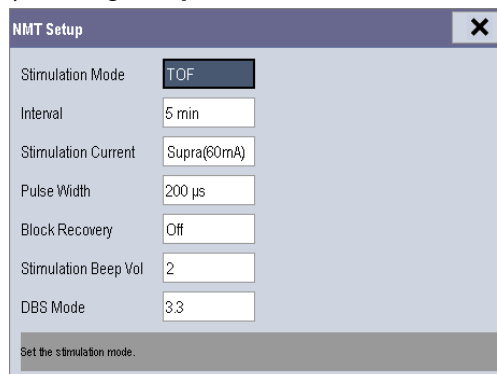

23.6 Calibrating the NMT Measurement

The size of the sensor signal varies from patient to patient. NMT calibration determines supramaximal stimulation current and the reference response amplitude. The reference response amplitude is the twitch at the supramaximal stimulation current when the patient is not paralyzed. The calibration must be done prior to administration of a muscle relaxant drug.

If **[Stimulation Current]** is set to **[Supra (60 mA)]**, the module automatically searches for supramaximal current to determine the reference response amplitude. If a value between 0 and 60 mA is selected, the reference response amplitude is determined using the selected stimulation current. For adults, the supramaximal current is usually between 35 and 55 mA.

To starting calibration,

1. Check that settings of **[Stimulation Current]** and **[Pulse Width]** are correct from the **[NMT Setup]** menu.
2. Press the Calibration key on the NMT module, or select **[Calibrate]** from the **[NMT Setup]** menu.

If calibration failed, the NMT module automatically use the default value as the reference amplitude.

NOTE

- **It is recommended that the patient be anesthetized before setting up the calibration twitch as nerve stimulation can be painful.**
 - **Changing the stimulation current or pulse width after calibration invalidates the stored reference data, and therefore recalibration is required.**
-

23.6.1 Starting/Stopping NMT Measurements

To Start NMT measurements,

- Press the Start/stop key on the NMT module, or
- Select the **[Start NMT]** key from the **[NMT Setup]** menu, or
- Select the shortcut key of desired stimulation mode, **[ST 0.1HZ]**, **[ST 1HZ]**, **[TOF]**, **[ST]**, **[DBS]**, or **[PTC]**, from the left side of the **[NMT Setup]** menu.

To Stop NMT measurements, press the Start/stop key on the NMT module, or select **[Stop all NMT]** in the **[NMT Setup]** menu. The measurement is interrupted immediately.

If you need to change the NMT settings after startup, stop the measurements, change the settings, and then restart the measurements.

NOTE

- **Take care when removing the sensor from the patient. Do not pull on the cable.**
-

23.7 Change NMT Measurement Settings

From the **[NMT Setup]** menu, you can change stimulation related settings.

23.7.1 Changing Stimulation Mode

The module provides four stimulation modes: TOF, ST, DBS, and PTC, see **23.3 Stimulation Modes** for detail.

In the **[NMT Setup]** menu, set **[Stimulation Mode]** to **[TOF]**, **[ST]**, or **[DBS]**. To perform tetanic stimulation, directly select the **[PTC]** button.

23.7.2 Changing Stimulation Current

Before calibration and monitoring, confirm that the desired stimulus current is selected.

The current is either supramaximal or manually selected between 0 and 60 mA. For adults, the supramaximal current is usually between 35 and 55 mA. Smaller currents may be desirable for children.

23.7.3 Changing Pulse Width

You can increase the pulse width to increase the effect of the stimulation to help finding the supramaximal current.

Changing pulse width after calibration invalidates the stored reference amplitude.

23.7.4 Changing Measurement Interval

Measurement interval is the time interval between NMT measurements.

This function is not available in the PTC mode.

23.8 Enabling Block Recovery Note

The block recovery note alerts you when the set limit is reached. This indicates that the patient is responding more clearly to the stimuli and the neuromuscular block is decreasing. The note can be used, for example, to help maintain a certain relaxation level.

To enable the note and set the limit for activate the note, select **[Block Recovery]** and set the limit. If **[Off]** is selected, the monitor will not give a note.

23.9 Adjusting Stimulation Tone Volume

You can adjust the volume of NMT stimulation tone by setting **[Stimulation Beep Vol]** from the **[NMT Setup]** menu. The monitor gives a beep at the selected volume at each stimulation pulse if the setting is not **[0]**.

23.10 Understanding NMT Display

Dependent on the selected stimulation mode, the following parameters are provided:

Stimulation mode	Parameter label	Unit	Maximum bars
TOF	TOF-Ratio	%	4
	TOF-Count	/	4
ST	ST-Ratio	%	1
	ST-Count	/	1
PTC	PTC	/	/
DBS	DBS-Ratio	%	2
	DBS-Count	/	2

The follow picture is an example of NMT display of TOF mode:

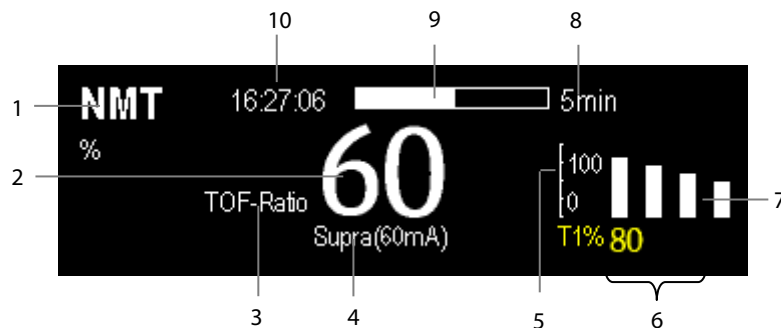

1. Parameter unit
2. Parameter value
3. Parameter label
4. Stimulation Current
5. Scale: indicates the amplitude of response to stimulation. Bar graph is not shown if calibration is not completed successfully.
6. T1%: response to first stimulus as percentage of the reference amplitude in TOF mode. This value is not shown if calibration is not completed successfully.
7. Bar graph: amplitude of response to the stimulation. The maximum height of the bar graphs displayed is 120%.
8. Measurement interval: The monitor displays "Manual" here if **[Interval]** is set to **[Manual]**.
9. Measurement countdown: time to the next measurement. The measurement countdown is not shown if **[Interval]** is set to **[Manual]**.
10. Time of last measurement

NOTE

- **The NMT parameter values darken 15 minutes after the NMT measurement is taken.**
- **The PTC value is shown on the display for 20 seconds after which the NMT module returns to the preset stimulation mode.**

23.11 Recalling Calibration Information

In the situation that the NMT module is power down, or you want move the NMT module to another monitor along with the patient and you want to continue with the already determined calibration information, including stimulation current, pulse width, and reference response amplitude, you can use the recall function.

To recall the calibration information, select the **[Restore Calibration Information]** button from the **[NMT Setup]** menu.

FOR YOUR NOTES

24 Device Integration

24.1 Introduction

The BeneLink module is intended for connecting external devices to the Passport17m or Passport 12m patient monitor. It allows the information (patient data, alarms, etc.) from the external device to be displayed, saved, recorded, printed, or calculated through the patient monitor. If the patient monitor is connected with the CMS or eGateway, information from the external device can also be transmitted to the CMS or eGateway.

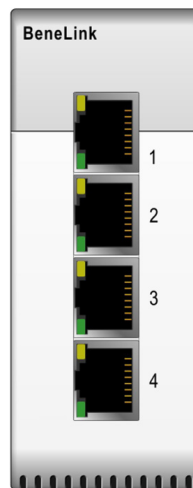

24.2 Safety Information

WARNING

- **Devices of the same category cannot be connected to the BeneLink module simultaneously.**
 - **A patient monitor supports only one BeneLink module.**
 - **The signal labels used on the patient monitor may be different from those given on the external device. For details please see the description of parameters and alarms in corresponding sections of this chapter.**
 - **The alarms from the external device may be advanced or delayed before transmission to the patient monitor.**
 - **There can be differences between the alarm priorities displayed on your patient monitors and the priorities displayed on the external devices interfaced through BeneLink. Please see the list of Output Signals corresponding with each external device for the alarm priorities used by your patient monitor.**
-

NOTE

- **Only monitors using software version 05.38.00 or later support BeneLink module software version 2.7 or later.**
-

24.3 Supported Devices and Device Connection Method

For the list of supported devices, device information, and device connection method, refer to ***BeneLink Module Operator's Manual (PN: 046-011948-00)***.

24.4 Differences in Displayed Values

In certain cases, there may be differences between the numerics seen on the patient monitor and those seen on the external device. The table below lists some situations and possible reasons.

Situation	Possible Reasons
Some parameter values are displayed as invalid values on the monitor.	The monitor and the external device may have different parameter configuration or displaying range of values. If the monitor displays a parameter that is not configured in the external device or a parameter value from the external device exceeds the displaying range of the monitor, the corresponding parameter value is displayed on the monitor as an invalid value.
The monitor and the external device may display the parameter values with different numbers of places of decimals.	The monitor displays the parameter values from the external device based on its own display rules. Same parameter value is displayed differently when the monitor and external device adopt different numbers of places of decimals of the value for display.
Non-continuously measured values and continuously measured values have the same displaying mode in the monitor.	Non-continuously measured values are displayed on the monitor as latest measured values until a new measurement is performed on the external device.
Differences between the parameter values displayed on the monitor and those displayed on the external device.	Some parameter values are converted to different units during transmission to the monitor so that they can be used for calculations. Sometimes, values from the external device may be advanced or delayed before transmission to the monitor.

NOTE

- **When the pressure units are converted among cmH₂O, hPa and mbar, the parameter value remains unchanged, for example, 1cmH₂O=1hPa=1mbar, which may differ from some external devices.**

24.5 Devices Integrated Window

You can view the external device information in the **[Devices Integrated]** window, which provides the information of both individual devices and multi devices. In the individual device menu, you can select **[Para. Display>>]**, **[Units>>]** or **[Alarms>>]** to set the parameters to be displayed, the parameter units, or view the alarm list.

Anesthesia		Vent Mode: VCV	
Ppeak cmH2O	18	MV L/min	4.5
Pplat cmH2O	15	f bpm	15(15)
Pmean cmH2O	6.0	I:E	1:2(1:2)
VT ml	(300)	TIP: T1 %	(25)
VTe ml	300	Plimit cmH2O	(30)
		Compl ml/cmH2O	17
		Raw cmH2O/L/s	9
		FiO2 %	23.0

Para. Display>> Units>> Alarms>>

The parameters in the **[Devices Integrated]** window are displayed in the order of priorities. If the window cannot display all the selected parameters, only parameters with the highest priority are displayed. For the parameters controlled by the external device, their settings display in parentheses.

In the **[Devices Integrated]** window, you can select the **[Multi Devices]** tab to view the parameter information of all the external devices interfaced currently. The displayed parameters are those selected in **[Para. Display]** menu of the individual device window. If the monitor cannot display all the selected parameters, only parameters of the highest priority are displayed.

24.6 System Functions of the Monitor

24.6.1 Alarms

The monitor does not display the realtime alarms from the external device. However, you can view the current alarm list of the corresponding device by selecting **[Alarms>>]** in the individual device window. The alarm priority is defined by a "*" before each alarm message. An alarm list can display up to 100 alarm messages.

24.6.2 Data Storage

The monitor can save and review the graphic trends, tabular trends, and alarm events of parameters from the external device. In the **[Graphic Trends]** menu and **[Events]** menu, parameters from the external device are displayed in white. In the **[Review]** menu, **[Trend Group]** menu, and **[Print Setup]** menu, a mark "+" is shown before each label of parameters from the external device. Please refer to the parameter list to see which parameters can be saved.

NOTE

- **Parameters from the external device are saved and displayed according to the time of the patient monitor.**
-

24.6.3 Recording and Printing

Information from the external device can be recorded and printed both in realtime and in graphic and tabular trends by the monitor. In addition, the monitor can also record the history of parameters of the external device.

25 Monitoring tcGas

25.1 Introduction

This monitor can connect an external device for continuous transcutaneous blood gas monitoring.

This monitor can display, store and review measurements from the external device, as well as present related alarms. On this monitor, you can separately set the level of tcGas related alarms and switch on or off alarm recording; you can also view the settings of alarm limits and alarm switch at the external device.

This monitor can integrate the following TCM monitors:

- TCM CombiM
- TCM TOSCA
- SenTec Digital Monitor (SDM)

25.2 Safety Information

WARNING

- **TCM CombiM monitor and TCM TOSCA monitor are manufactured by Radiometer Medical ApS. This company provides the technology for measuring tcGas parameters. We only provide the connection between this monitor and TCM monitors.**
 - **The SenTec Digital Monitor (SDM) is manufactured by SenTec AG. This company provides the technology for measuring tcGas parameters. We only provide the connection between this patient monitor and the SenTec Digital Monitor.**
 - **If you have any doubts about the operation and maintenance of an external device, please refer to the operator's manual of the external device or directly contact its manufacturer.**
 - **Fully observe the operator's manual of the external device to make settings and to connect the external device with a patient.**
 - **For the intended use and contraindication of the external devices, refer to their operator's manuals.**
-

25.3 Connecting an External Device

The TCM monitor connects with BeneLink module through an ID adapter. For how to establish connection between the TCM monitor and the BeneLink module, refer to ***BeneLink Module Operator's Manual (PN: 046-011948-00)***.

25.4 tcGas Parameters

TCM CombiM monitor provides the following measurements:

- tcpCO₂
- tcpO₂
- Power
- Tsensor

In which, tcpCO₂ and tcpO₂ are primary parameters, and the others are secondary parameters.

TCM TOSCA provides the following measurements:

- tcpCO₂
- SpO₂
- PR
- Power
- Tsensor

In which, tcpCO₂ is primary parameter, and the others are secondary parameters.

SenTec SDMS tcPCO₂ provides the following measurements:

- tcpCO₂
- tcpO₂
- SpO₂
- PR
- Power
- Tsensor

In which up to two parameters can be selected as primary parameters and the others are secondary parameters.

Options for primary parameters are tcpCO₂, tcpO₂, SpO₂, and PR, with tcpCO₂ and tcpO₂ being the defaults.

NOTE

-
- **On the SenTec Digital Monitor it is possible to disable/enable the parameters to be monitored. For tcpO₂ Monitoring, an OxiVenT™ Sensor with activated PO₂-option is required. If the SenTec Digital Monitor is operated in neonatal mode, SpO₂ and PR are not supported.**
-

25.5 Displaying tcGas Parameters

To display tcGas parameters on this monitor:

1. Select the **[Screen Setup]** button  to enter the **[Screens]** window.
2. Select **[Screen Setup]**. You can choose where to display the tcGas parameters on the screen.

25.6 Entering the tcGas Setup menu

You can access the **[+tcGas Setup]** menu by selecting the tcGas area or selecting **[Main Menu]→[Parameters >>]→[+tcGas Setup>>]**.

In the **[+tcGas Setup]** menu, you can:

- Set **[Alarm Sound]** to **[On]** or **[Off]** to switch on or off tcGas alarms on the monitor.
- Choose the secondary parameters to be displayed. The tcGas area can display maximum three secondary parameters.

For TCM CombiM monitor, only two secondary parameters, Power and Tsensor, are measured in the **[+tcGas Setup]** menu. The option **[Change Secondary Parameters >>]** is not available.

- Set alarm level for tcGas parameters, and switch on or off alarm record.

25.7 Setting tcpCO₂/tcpO₂ Unit

To set the tcpCO₂/tcpO₂ unit:

1. Select **[Main Menu]→[Maintenance >>]→[User Maintenance >>]**→enter the required password→**[Maintain CO₂ >>]**.
2. Select **[Unit Setup >>]** and set **[tcpCO₂/tcpO₂ Unit]** to **[mmHg]** or **[kPa]**.

25.8 tcGas Display

If TCM CombiM monitor is connected, the tcGas area is shown as follows:

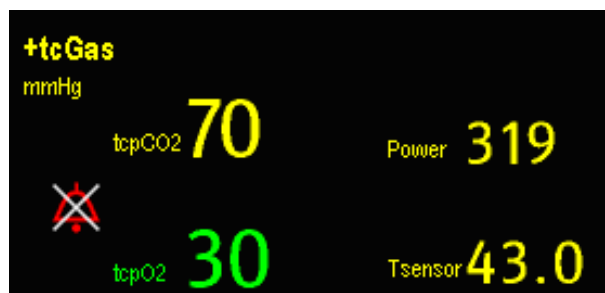

If TCM TOSCA monitor is connected, the tcGas area is shown as follows:

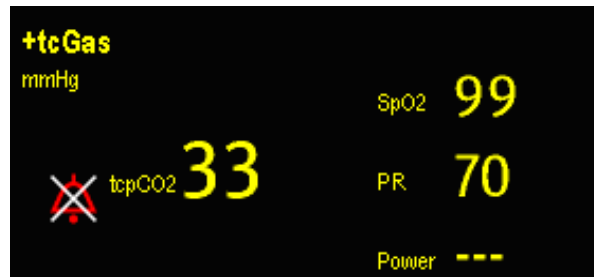

If SenTec Digital Monitor is connected, the tcGas area is shown as follows:

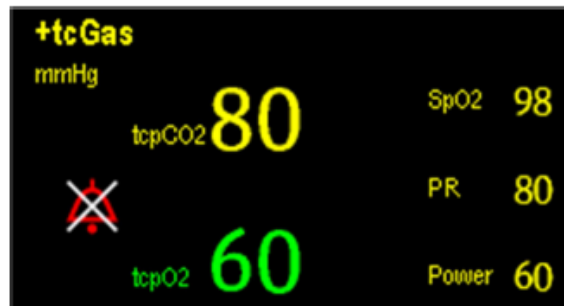

26 Freezing Waveforms

During patient monitoring, the freeze feature allows you to freeze the currently displayed waveforms on the screen so that you can have a close examination of the patient's status. Additionally, you can select any frozen waveform for recording.

26.1 Freezing Waveforms

To freeze waveforms, select the **[Freeze]** hardkey on the monitor's front panel.

- The system closes the displayed menu (if any), and opens the **[Freeze]** menu.
- All displayed waveforms are frozen, i.e. the waveforms stop being refreshed.

NOTE

- **The freeze feature does not affect the split-screen view of minitrends, OxyCRG and other patients.**
-

26.2 Viewing Frozen Waveforms

To view the frozen waveforms, you can either:

- Select the **[Scroll]** button and then rotate the knob clockwise or counter-clockwise, or
- Directly select the ◀ or ▶ beside the **[Scroll]** button using a mouse or through the touchscreen.

The frozen waveforms will scroll left or right accordingly. And meanwhile, at the lower right corner of the last waveform, there is an upward arrow. The freeze time displays below the arrow and the initial frozen time is **[0 s]**. With the waveforms scrolling, the freeze time changes at intervals of 1 second. This change will be applied for all waveforms on the screen.

26.3 Unfreezing Waveforms

To unfreeze the frozen waveforms, you can either:

- Select the  button at the upper right corner of the **[Freeze]** menu,
- Select the **[Freeze]** hardkey on the monitor's front panel, or
- Perform any other action that causes the screen to be readjusted or opens a menu, such as inserting or removing a module, pressing the **[Menu]** hardkey, etc.

26.4 Recording Frozen Waveforms

To record the frozen waveforms:

1. In the **[Freeze]** menu, select, in order, **[Wave 1]**, **[Wave 2]** or **[Wave 3]** and then select your desired waveforms.
2. Select the **[Record]** button. The selected waveforms and all numerics at the frozen time are printed out by the recorder.

27 Review

27.1 Accessing Respective Review Windows

To access the review windows:

1. Select the [Review] QuickKey, or [Main Menu]→[Review >>].
2. Select [Graphic Trends], [Tabular Trends], [Events], [Full Disclosure] or [12-lead ECG] to access their respective review windows.

27.2 Reviewing Graphic Trends



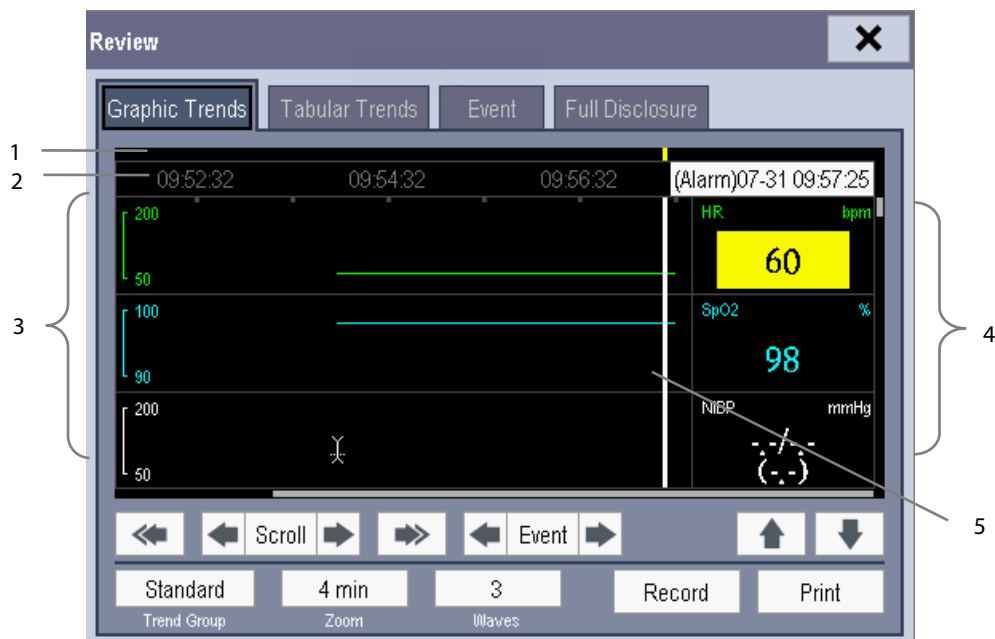

In the [Review] menu, select [Graphic Trends] to access the following window.





1. Event mark area
2. Time axis
3. Graphic trends area
4. Parameter area
5. Cursor

Events are marked with colors in the event mark area. Red represents high level alarm event. Yellow represents medium/low level alarm event. Green represents manual event.

In this review window:

- Select **[Trend Group]** and you can select a trend group for viewing in the pop-up menu. If **[Custom 1]** or **[Custom 2]** is selected, you can further select **[Define Trend Group]**. Then you can select the parameters for viewing in the pop-up menu.
- Select **[Zoom]** to set the time length of the review window.
- Select **[Waves]** to set the number of waves displayed in one page.
- To browse the graphic trends, you can either:
 - ◆ Select  or  beside **[Scroll]** to move the cursor one step to the left or right to navigate through the graphic trends, or
 - ◆ Select  or  to move the cursor one page to the left or right to navigate through the graphic trends.

A time indicating your current position displays above the parameter area. Numeric measurement values corresponding to the cursor location change as the cursor is moved. The measurement value that triggered a high level alarm has a red background. The one that triggered a medium/low level alarm has a yellow background.

- Select  or  beside **[Event]** to position the cursor to a different event time.
- Select the **[Record]** button to print the currently displayed graphic trends to the recorder.
- Select the **[Print]** button to set and print the graphic trends report by the printer. For how to set the graphic trends report, refer to chapter **29 Printing**.

27.3 Reviewing Tabular Trends



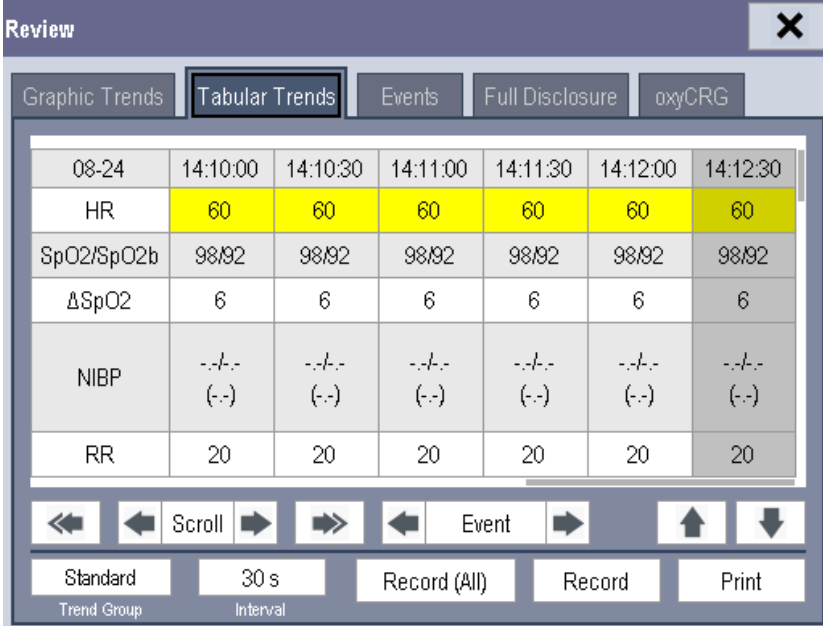

In the **[Review]** menu, select **[Tabular Trends]** to access the **[Tabular Trends]** window.





	08-24	14:10:00	14:10:30	14:11:00	14:11:30	14:12:00	14:12:30
HR		60	60	60	60	60	60
SpO2/SpO2b		98/92	98/92	98/92	98/92	98/92	98/92
ΔSpO2		6	6	6	6	6	6
NIBP		-.- (-.)	-.- (-.)	-.- (-.)	-.- (-.)	-.- (-.)	-.- (-.)
RR		20	20	20	20	20	20

Events are marked with colors in window's top area. Red represents high level alarm event. Yellow represents medium/low level alarm event. Green represents manual event.

In this review window:

- Select **[Trend Group]** and you can select a trend group for viewing in the pop-up menu. If **[Custom 1]** or **[Custom 2]** is selected, you can further select **[Define Trend Group]**. Then you can select the parameters for viewing in the pop-up menu.
- Select **[Interval]** to change the resolution of the trend data and then select the appropriate setting:
 - ◆ **[5 s]** or **[30 s]**: select to view up to 4 hours of tabular trends at 5- or 30-second resolution.
 - ◆ **[1 min]**, **[5 min]**, **[10 min]**, **[15 min]**, **[30 min]**, **[1 h]**, **[2 h]** or **[3 h]**: select to view up to 120 hours of tabular trends at your selected resolution.
 - ◆ **[NIBP]**: select to view the tabular trends when NIBP measurements were acquired.
- To browse the tabular trends, you can either:
 - ◆ Select  or  beside **[Scroll]** to drag the scrollbar left or right to navigate through the trend database, or
 - ◆ Select  or  to scroll left or right to navigate through the trend database.

The measurement value that triggered a high level alarm has a red background. The one that triggered a medium/low level alarm has a yellow background.

- Select  or  beside **[Event]** to position the cursor to a different event time.
- Select the **[Record]** button to access the **[Record Setup]** menu and set the start and end time of the tabular trends you want to record. This feature is not available when reviewing a patient's history. By further selecting **[Record]**, you can print the displayed tabular trends to the recorder.
- Select the **[Record (All)]** button to print all of the tabular trends to the recorder. The trends will be printed in reverse chronological order from the current time to the last time a patient was admitted to the patient monitor.
- Select the **[Print]** button to set and print out the tabular trends report to the printer. For how to set the tabular trends report, refer to chapter **29 Printing**.

27.4 Reviewing Events

27.4.1 Marking Events

During patient monitoring, some events may affect the patient and change the displayed waveforms or numerics displayed on the monitor. To help analyze these waveforms or numeric changes, you can mark these events.

Select **[Main Menu]**→**[Mark Event >>]**. In the pop-up menu, you can select the waves to store after triggering a manual event. You can select **[Trigger Manual Event]** from the **[Mark Event]** menu or the **[Manual Event]** from the **[Main Menu]** to trigger a manual event and store it at the same time.

When you are reviewing graphic trends, tabular trends or full-disclosure waveforms, the manual event symbol is displayed at the time the event is triggered.

27.4.2 Reviewing Events

The monitor saves the events in real time. You can review these events.

In the [Review] menu, select [Events] to access the [Events] tab. You can review parameter alarm events, arrhythmia alarm events and manual events. When an event occurs, the system stores all the measurement numerics at the event triggering time and related waveforms 4 seconds, 8 seconds, or 16 seconds before and after the event triggering time, as per the setting of recording length.

NOTE

- Pausing or switching off alarms will not be recorded as events. The time of these operations will not be recorded in the system log.
- Earlier-recorded events might be overwritten by later ones if the events log reaches capacity.

In the [Events] tab:

- Select [Event] to view the desired events.
- Select [Level] to view the desired events according to the alarm priority.

After selecting the desired event, you can select [Details] to access the following window. In this window, the waveform area displays the waveforms related to the event, and the parameter area displays the parameter values happened at the event trigger time.

NOTE

- A total loss of power has no impact on the saved events.

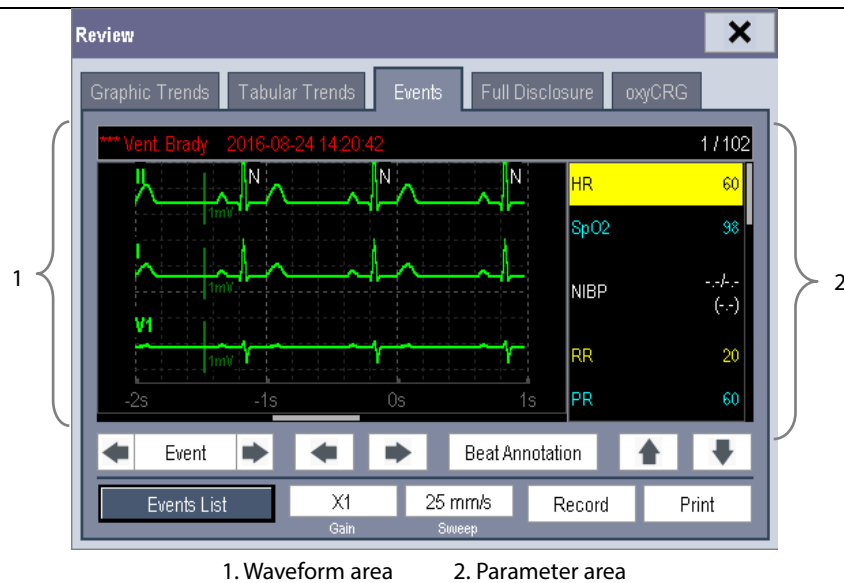

In this window:

- You can select or to navigate through the waveforms.
- You can select or beside the [Event] button to switch between events.

- By selecting the **[Beat Annotation]** button, you can display or hide beat labels above the first ECG waveform on the screen. The white beat labels indicate how the monitor is classifying beats and may help explain suspected, missed, or false arrhythmia calls.
 - ◆ N = Normal
 - ◆ V = Ventricular Ectopic
 - ◆ S = Supraventricular Premature
 - ◆ P = Paced
 - ◆ L = Learning
 - ◆ ? = Insufficient information to classify beats
 - ◆ I = Inoperative (for example, Lead Off)
 - ◆ M = No beat detected

When beat labels are displayed above the ECG waveform, they can be printed via the recorder or a laser printer. If you select **[Beat Annotation]** in the **[Events]** tab to display or hide beat labels, these beat labels will also be displayed or hidden in the **[Full Disclosure]** tab, and vice versa.

CAUTION

- **Ensure that you have selected the optimal leads with the best waveform amplitude and the highest signal-to-noise ratio. Selecting the optimal leads is important for beat detection, beat classification, and V-Fib detection.**
-

- You can set the desired **[Gain]** for ECG waveform.
- You can set the desired **[Sweep]**.
- Select the **[Record]** button to print the displayed alarm events to the recorder.
- Select the **[Print]** button to print the displayed alarm events to the pre-connected laser printer.
- Select the **[Events List]** button to view the events list.

27.5 Reviewing Waveforms

In the **[Review]** menu, select **[Full Disclosure]** to access the following window.

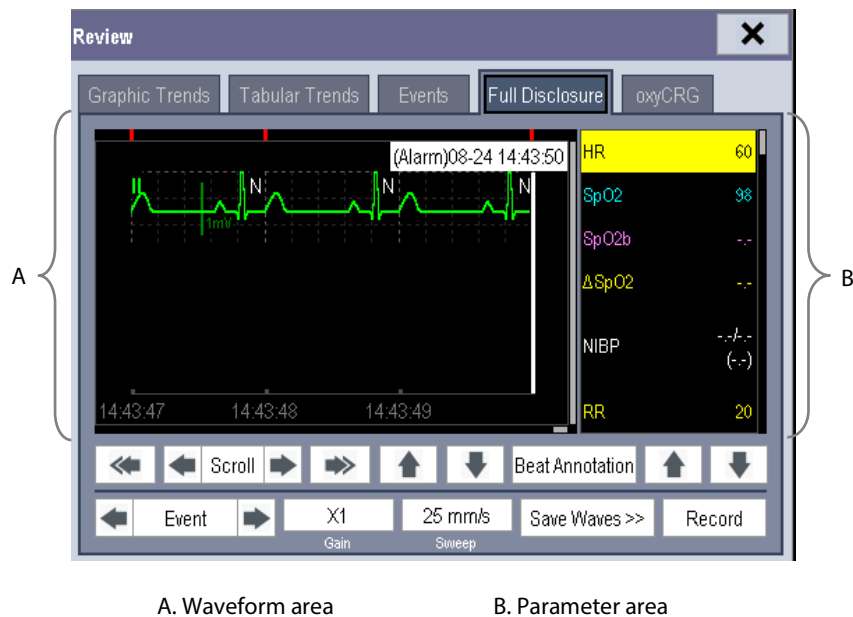

In this review window:

- To review full-disclosure waveforms, you need to save waveforms first. Select **[Save Waves >>]** and then select the parameters whose waveforms you want to view. To save full-disclosure waveforms, your monitor must have a CF storage card.

- To view the waveforms, you can either:

- ◆ Select or beside the **[Scroll]** button to move the cursor one step left or right to navigate through the waveforms, or
- ◆ Select or to move the cursor one page left or right to navigate through the waveforms.

A time indicating your current position is displayed at the top of the waveform area. Numeric measurement values corresponding to the cursor location are displayed in the parameter area, and change as the cursor is moved.

- By selecting the **[Beat Annotation]** button, you can display or hide beat labels above the first ECG waveform on the screen. For more information on the beat annotation function, refer to the section **27.4.2 Reviewing Events**.
- You can change the ECG wave gain by selecting **[Gain]** and then selecting the appropriate setting.
- You can change the waveform sweep speed by selecting **[Sweep]** and then selecting the appropriate setting.
- You can select the **[Record]** button to print out the first three waveforms and measurement numerics to the recorder.
- You can select or beside the **[Event]** button to position the cursor between events.

27.6 Reviewing OxyCRG

In the [Review] menu, select [OxyCRG] tab to access the following window.

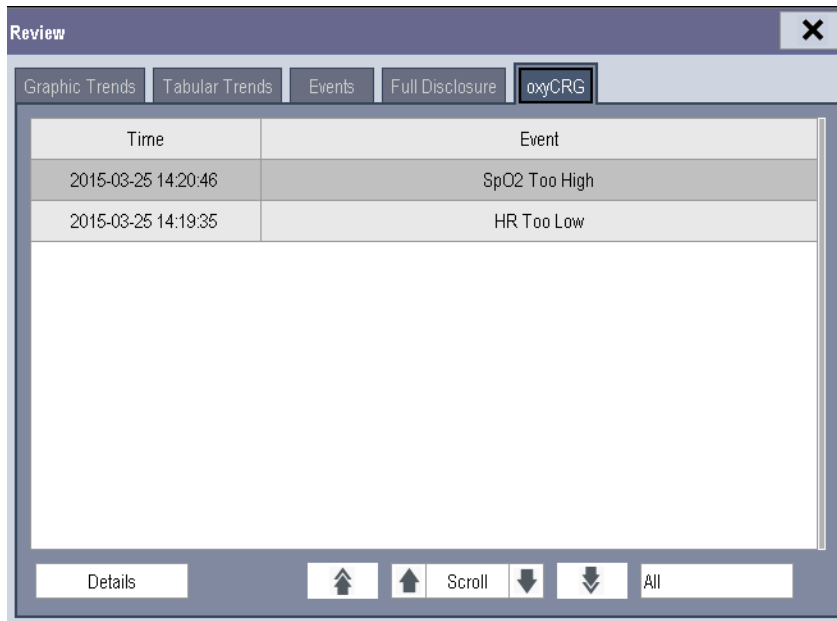





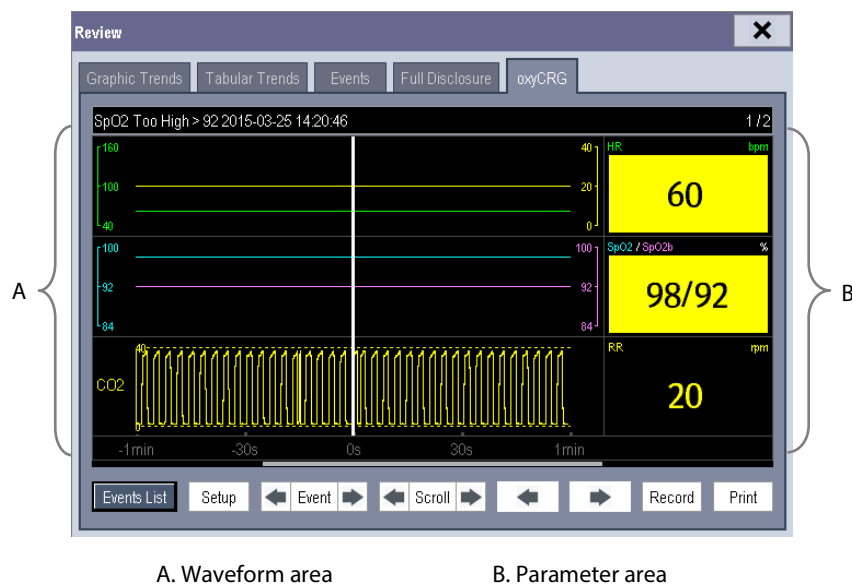

In this window:

- Select [Details] to view the trends, waveform and measurement numerics of selected parameters.
- Select ↑ or ↓ beside the [Scroll] button to switch between events.
- Select ⬆ or ⬇ to switch between pages.
- Select the button at the lower right corner of this window to change the parameter events to be displayed.

After selecting the [Details] button, you can access the following window. In this window, the waveform area displays the trends and waveform of the OxyCRG, and the parameter area displays the parameter values at the event trigger time.



In this window:

- Select **[Events List]** to switch to the OxyCRG events list.
- Select **[Setup]** to change the displayed parameters.
- Select  or  beside the **[Event]** button to adjust the position of the cursor between events.
- Select  or  beside the **[Scroll]** button to move the cursor one step left or right to navigate through the trends and waveform.
- Select  or  to navigate through the parameter trends and waveform.
- Select the **[Record]** button to print out the currently displayed trends, waveform, and measurement numerics by the recorder.
- Select the **[Print]** button to print to the independent printer.

28 Calculations

28.1 Introduction

The calculation feature is available with your monitor. The calculated values, which are not directly measured, are computed based on the values you provide.

You can perform the following calculations:

- Dose calculations
- Oxygenation calculations
- Ventilation calculations
- Hemodynamic calculations
- Renal calculations

To perform a calculation, select **[Main Menu]** → **[Calc >>]**, or the **[Calculations]** QuickKey and then select the calculation you want to perform.

Upon completion of a calculation, calculation results will be automatically sent to the central monitoring system and eGateway.

WARNING

- **After the calculation is finished, verify the entered values are correct and the calculated values are appropriate. We assume no responsibility for any consequences caused by wrong entries and improper operations.**

NOTE

- **The calculation feature is independent of other monitoring functions and can be therefore used for patients being monitored by other monitors. Any operation in a calculation window does not affect the patient monitoring by the local monitor.**
-

28.2 Dose Calculations

28.2.1 Performing Calculations

To perform a dose calculation:

1. Select [**Main Menu**]→[**Cal >>**]→[**Dose >>**], or select [**Calculations**] QuickKey→[**Dose >>**].
2. Select [**Patient Cat.**] and [**Drug Name**] and then select the appropriate settings. The dose calculation program has a library of commonly used drugs, of which Drug A through Drug E are for those not specified in this library.
 - ◆ Drug A, B, C, D, E
 - ◆ Aminophylline
 - ◆ Dobutamine
 - ◆ Dopamine
 - ◆ Epinephrine
 - ◆ Heparin
 - ◆ Isuprel
 - ◆ Lidocaine
 - ◆ Nipride
 - ◆ Nitroglycerin
 - ◆ Pitocin
3. The system gives a set of default values when the above steps are finished. However, these values cannot be used as the calculated values. The user must enter values following the doctor's instructions, and only then can the calculated values be used
4. Enter the patient's weight.
5. Enter other values.
6. Verify if the calculated values are correct.

28.2.2 Selecting the Proper Drug Unit

Each drug has its fixed unit or unit series. Among a unit series, one unit may change to another automatically depending on the entered value.

The units for each drug are as follows:

- Drug A, B, C, Aminophylline, Dobutamine, Dopamine, Epinephrine, Isuprel, Lidocaine, Nipride and Nitroglycerin use the unit series: g, mg and mcg.
- Drug D, Heparin and Pitocin use the unit series: Unit, KU (kilo units) and MU (million units).
- Drug E uses the unit: mEq (milli-equivalents).

You must select the proper drug name (A, B, C, D or E) according to the units when you define a drug not listed in this library.

NOTE

- For neonate patients, [Drip Rate] and [Drop Size] are disabled.

28.2.3 Titration Table





To open the titration table, select **[Titration Table >>]** in the **[Dose Calculation]** window after the dose calculation is finished.

In the titration table, when you change:

- **[Reference]**
- **[Interval]**
- **[Dose Type]**

The titrated values change accordingly.

You can also:

- Select  or , or  or  beside the vertical scrollbar to view more values.
- Select **[Record]** to print the displayed titrated values by the recorder.

28.2.4 Drug Calculation Formulas

Abbreviation	Unit	Formula
Conc.	g/ml, unit/ml or mEq/ml	Amount / Volume
Dose	Dose/hr, Dose/kg/min	Rate × Conc.
Volume	ml	Rate × Duration
Amount	g, unit, mEq	Rate × Duration
Duration	h	Amount/Dose
Drip Rate	gtt/min	INF Rate × Drop Size / 60

28.3 Oxygenation Calculations

28.3.1 Performing Calculations

To perform an oxygenation calculation:

1. Select **[Main Menu]**→**[Cal >>]**→**[Oxygenation >>]**, or select **[Calculations]** QuickKey→**[Oxygenation >>]**.
2. Enter values for calculation.
3. Select the **[Calculate]** button. The system performs a calculation per the current settings and displays the calculated values.
 - ◆ If a calculated value is outside the range, its background will highlight in yellow. You can select **[Range]** to view its normal range in the unit field.
 - ◆ Invalid values are displayed as [---].

In the **[Oxygenation Calculation]** window, you can:

- Change the pressure unit, Hb unit and oxygen content unit by selecting **[Press. Unit]**, **[Hb Unit]** and **[OxyCont Unit]** and then selecting the appropriate settings. The changes take effect automatically.
- Trigger a recording by selecting the **[Record]** button. The displayed oxygenation calculations are printed out by the recorder.
- Review the previously performed calculations by selecting **[Review]**.

28.3.2 Entered Parameters

Abbreviation	Unit	Full spelling
C.O.	L/min	cardiac output
FiO ₂	%	percentage fraction of inspired oxygen
PaO ₂	mmHg	partial pressure of oxygen in the arteries
PaCO ₂	mmHg	partial pressure of carbon dioxide in the arteries
SaO ₂	%	arterial oxygen saturation
PvO ₂	mmHg	partial pressure of oxygen in venous blood
SvO ₂	%	venous oxygen saturation
Hb	g/L	hemoglobin
CaO ₂	ml/L	arterial oxygen content
CvO ₂	ml/L	venous oxygen content
VO ₂	ml/min	oxygen consumption
RQ	None	respiratory quotient
ATMP	mmHg	atmospheric pressure
Height	cm	height
Weight	kg	weight

28.3.3 Calculated Parameters and Formulas

Abbreviation	Unit	Full spelling	Formula
BSA	m ²	body surface area	$Wt^{0.425} \times Ht^{0.725} \times 0.007184$
VO ₂ calc	ml/min	oxygen consumption	$C(a-v)O_2 \times C.O.$
C(a-v)O ₂	ml/L	arteriovenous oxygen content difference	$CaO_2 - CvO_2$
O ₂ ER	%	oxygen extraction ratio	$100 \times C(a-v)O_2 / CaO_2$
DO ₂	ml/min	oxygen transport	$C.O. \times CaO_2$
PAO ₂	mmHg	partial pressure of oxygen in the alveoli	$FiO_2 / 100 \times (ATMP - 47) - PaCO_2 \times [FiO_2 / 100 + (1 - FiO_2 / 100) / RQ]$
AaDO ₂	mmHg	alveolar-arterial oxygen difference	$PAO_2 - PaO_2$
CcO ₂	ml/L	capillary oxygen content	$Hb \times 1.34 + 0.031 \times PAO_2$
Qs/Qt	%	venous admixture	$100 \times [1.34 \times Hb \times (1 - SaO_2 / 100) + 0.031 \times (PAO_2 - PaO_2)] / [1.34 \times Hb \times (1 - SvO_2 / 100) + 0.031 \times (PAO_2 - PvO_2)]$
C.O. calc	L/min	calculated cardiac output	$VO_2 / (CaO_2 - CvO_2)$

28.4 Ventilation Calculations

28.4.1 Performing Calculations

To perform a ventilation calculation:

1. Select **[Main Menu]**→**[Cal>>]**→**[Ventilation >>]**, or select **[Calculations]** QuickKey→**[Ventilation >>]**.
2. Enter values for calculation. If the monitor is connected to an anesthesia machine or a ventilator, the system automatically loads the supported parameter values to the **[Ventilation Calculation]** window.
3. Select the **[Calculate]** button. The system performs a calculation per the current settings and displays the calculated values.
 - ◆ If a calculated value is outside the range, its background will highlight in yellow. You can select **[Range]** to view its normal range in the unit field.
 - ◆ Invalid values are displayed as [---].

In the **[Ventilation Calculation]** window, you can:

- Change the pressure unit by selecting **[Press. Unit]** and then selecting the appropriate setting. Corresponding pressure values shall convert and update automatically.
- Select the **[Record]** button to record the displayed ventilation calculations to the recorder.
- Review the previously performed calculations by selecting **[Review]**.

28.4.2 Entered Parameters

Abbreviation	Unit	Full spelling
FiO ₂	%	percentage fraction of inspired oxygen
RR	rpm	respiration rate
PeCO ₂	mmHg	partial pressure of mixed expiratory CO ₂
PaCO ₂	mmHg	partial pressure of carbon dioxide in the arteries
PaO ₂	mmHg	partial pressure of oxygen in the arteries
TV	ml	tidal volume
RQ	None	respiratory quotient
ATMP	mmHg	atmospheric pressure

28.4.3 Calculated Parameters and Formulas

Abbreviation	Unit	Full spelling	Formula
PAO ₂	mmHg	partial pressure of oxygen in the alveoli	$(ATMP - 47) \times FiO_2 / 100 - PaCO_2 \times [FiO_2 / 100 + (1 - FiO_2 / 100) / RQ]$
AaDO ₂	mmHg	alveolar-arterial oxygen difference	$PAO_2 - PaO_2$
Pa/FiO ₂	mmHg	oxygenation ratio	$100 \times PaO_2 / FiO_2$
a/AO ₂	%	arterial to alveolar oxygen ratio	$100 \times PaO_2 / PAO_2$
MV	L/min	minute volume	$(TV \times RR) / 1000$
Vd	ml	volume of physiological dead space	$TV \times (1 - PeCO_2 / PaCO_2)$
Vd/Vt	%	physiologic dead space in percent of tidal volume	$100 \times Vd / TV$
VA	L/min	alveolar volume	$(TV - Vd) \times RR / 1000$

28.5 Hemodynamic Calculations

28.5.1 Performing Calculations

To perform a hemodynamic calculation:

1. Select [**Main Menu**]→[**Cal >>**]→[**Hemodynamic >>**], or select [**Calculations**] QuickKey→[**Hemodynamic >>**].
2. Enter values for calculation.
 - ◆ For a monitored patient, [**HR**], [**Art mean**], [**PA mean**] and [**CVP**] are automatically taken from the currently measured values. If you have just performed C.O. measurements, [**C.O.**] is the average of multiple thermodilution measurements. [**Height**] and [**Weight**] are the patient's height and weight you have entered. If the monitor does not provide these values, their fields are blank.
 - ◆ For a monitored patient, confirm the entered values.
3. Select the [**Calculate**] button. The system performs a calculation per the current settings and displays the calculated values.
 - ◆ If a calculated value is outside the range, its background will highlight in yellow. You can select [**Range**] to view its normal range in the unit field.
 - ◆ Invalid values are displayed as [---].

In the [**Hemodynamic Calculation**] window, you can:

- Trigger a recording by selecting the [**Record**] button. The currently displayed hemodynamic calculations are printed out by the recorder.
- Review the previously performed calculations by selecting [**Review**].

28.5.2 Entered Parameters

Abbreviation	Unit	Full spelling
C.O.	L/min	cardiac output
HR	bpm	heart rate
PAWP	mmHg	pulmonary artery wedge pressure
Art Mean	mmHg	artery mean pressure
PA Mean	mmHg	pulmonary artery mean pressure
CVP	mmHg	central venous pressure
EDV	ml	end-diastolic volume
Height	cm	height
Weight	kg	weight

28.5.3 Calculated Parameters and Formulas

Abbreviation	Unit	Full spelling	Formula
BSA	m ²	body surface area	$Wt^{0.425} \times Ht^{0.725} \times 0.007184$
C.I.	L/min/m ²	cardiac index	C.O. / BSA
SV	ml	stroke volume	C.O. / HR × 1000
SI	ml/m ²	stroke index	SV / BSA
SVR	DS/cm ⁵	systemic vascular resistance	$79.96 \times (AP\ MAP - CVP) / C.O.$
SVRI	DS·m ² /cm ⁵	systemic vascular resistance index	SVR × BSA
PVR	DS/cm ⁵	pulmonary vascular resistance	$79.96 \times (PAMAP - PAWP) / C.O.$
PVRI	DS·m ² /cm ⁵	pulmonary vascular resistance index	PVR × BSA
LCW	kg·m	left cardiac work	$0.0136 \times APMAP \times C.O.$
LCWI	kg·m/m ²	left cardiac work index	LCW / BSA
LVSW	g·m	left ventricular stroke work	$0.0136 \times APMAP \times SV$
LVSWI	g·m/m ²	left ventricular stroke work index	LVSW / BSA
RCW	kg·m	right cardiac work	$0.0136 \times PAMAP \times C.O.$
RCWI	kg·m/m ²	right cardiac work index	RCW / BSA
RVSW	g·m	right ventricular stroke work	$0.0136 \times PAMAP \times SV$
RVSWI	g·m/m ²	right ventricular stroke work index	RVSW / BSA
EF	%	ejection fraction	$100 \times SV / EDV$

28.6 Renal Calculations

28.6.1 Performing Calculations

To perform a renal calculation:

1. Select **[Main Menu]** → **[Cal >>]** → **[Renal >>]**, or select **[Calculations]** QuickKey → **[Renal >>]**.
2. Enter values for calculation.
3. Select the **[Calculate]** button. The system performs a calculation per the current settings and displays the calculated values.
 - ◆ If a calculated value is outside the range, its background will highlight in yellow. You can select **[Range]** to view its normal range in the unit field.
 - ◆ Invalid values are displayed as [---].

In the **[Renal Calculation]** window, you can:

- Trigger a recording by selecting the **[Record]** button. The displayed renal calculations are printed by the recorder.
- Review the previously performed calculations by selecting **[Review]**.

28.6.2 Entered Parameters

Abbreviation	Unit	Full spelling
URK	mmol/L	urine potassium
URNa	mmol/L	urinary sodium
Urine	ml/24h	urine
Posm	mOsm/ kgH ₂ O	plasma osmolality
Uosm	mOsm/ kgH ₂ O	urine osmolality
SerNa	mmol/L	serum sodium
Cr	μmol/L	creatinine
UCr	μmol/L	urine creatinine
BUN	mmol/L	blood urea nitrogen
Height	cm	height
Weight	kg	weight

28.6.3 Calculated Parameters and Formulas





Abbreviation	Unit	Full spelling	Formula
URNaEx	mmol/24h	urine sodium excretion	$\text{Urine} \times \text{URNa} / 1000$
URKEx	mmol/24h	urine potassium excretion	$\text{Urine} \times \text{URK} / 1000$
Na/K	%	sodium potassium ratio	$100 \times \text{URNa} / \text{URK}$
CNa	ml/24h	clearance of sodium	$\text{URNa} \times \text{Urine} / \text{SerNa}$
Clcr	ml/min	creatinine clearance rate	$\text{Ucr} \times \text{Urine} / \text{Cr} / (\text{BSA} / 1.73) / 1440$
FENa	%	fractional excretion of sodium	$100 \times (\text{URNa} \times \text{Cr}) / (\text{SerNa} \times \text{Ucr})$
Cosm	ml/min	osmolar clearance	$\text{Uosm} \times \text{Urine} / \text{Posm} / 1440$
CH ₂ O	ml/h	free water clearance	$\text{Urine} \times (1 - \text{Uosm} / \text{Posm}) / 24$
U/P osm	None	urine to plasma osmolality ratio	$\text{Uosm} / \text{Posm}$
BUN/Cr	None*	blood urea nitrogen creatinine ratio	$1000 \times \text{BUN} / \text{Cr}$
U/Cr	None	urine-serum creatinine ratio	Ucr / Cr

*: BUN/Cr is a ratio under the unit of mol.

28.7 Understanding the Review Window

With the review feature, you can review oxygenation, ventilation, hemodynamic and renal calculations. The review window for each calculation is similar. Take the hemodynamic calculations review window for example, you can access it by selecting **[Review]** in the **[Hemodynamic Calculation]** window.

In this review window:

- You can select , ,  or  to view more values.
- The values that exceed the range are displayed in a yellow background. The **[Unit]** field displays parameter units. If some parameter values are outside of their normal ranges, you can view their normal range in the **[Unit]** field by selecting **[Range]**.
- You can review an individual calculation by selecting its corresponding column and then selecting **[Original Calc]**. You can record the currently displayed calculations or perform another calculation in this window.

29 Recording

29.1 Using a Recorder

The thermal recorder prints patient information, measurement numeric, and waveforms, etc.

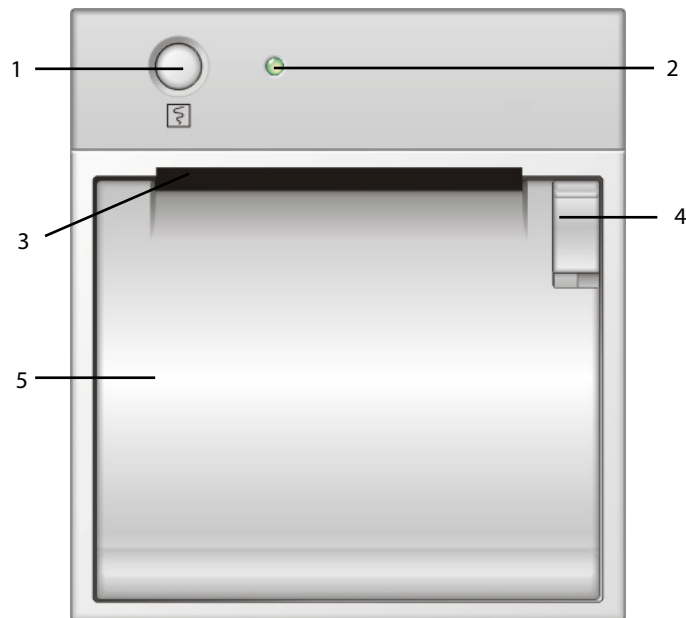

1. Start/Stop key: press to start a recording or stop the current recording.
2. Indicator
 - ◆ On: when the recorder works correctly.
 - ◆ Off: when the monitor is switched off.
 - ◆ Flashes: if an error occurred to the recorder, e.g., the recorder runs out of paper.
3. Paper outlet
4. Latch
5. Recorder door

29.2 Overview of Recording Types

By the way recordings are triggered, the recordings can be classified into the following categories:

- Manually-triggered realtime recordings.
- Timed recordings.
- Alarm recordings triggered by an alarm limit violation or an arrhythmia event.
- Manually-triggered, task-related recordings.

NOTE

- For details about alarm recording, refer to the chapter 7 Alarms .
- For details about task-related recordings, refer to respective sections of this manual.

29.3 Starting and Stopping Recordings

To manually start a recording, you can either:

- Press the **[Record]** hardkey on the front of the monitor;
- Press the  hardkey on the front of the recorder module; or
- Select the **[Record]** button from the current menu or window.

Automatic recordings will be triggered in the following conditions:

- Timed recordings will start automatically at preset intervals.
- If both **[Alarm]** and **[Alm Rec]** for a measurement are set on, an alarm recording will be triggered automatically as alarms occur.

When a recording is in process, to manually stop the recording, you can either:

- Press the **[Record]** hardkey on the front of the monitor;
- Press the  hardkey on the front of the recorder module; or
- Select **[Clear All Tasks]** in the **[Record Setup]** menu.

Recordings stop automatically when:

- A recording is completed.
- The recorder runs out of paper.
- When the recorder has an alarm condition.

When a recording is stopped, the following markers will be added:

- Automatically stopped recording: prints two columns of '*' at the end of the report.
- Manually or abnormally stopped recording: prints one column of '*' at the end of the report.

29.4 Setting up the Recorder

29.4.1 Accessing the Record Setup Menu

To access the **[Record Setup]** menu, select **[Main Menu]** → **[Record Setup >>]**.

29.4.2 Selecting Waveforms for Recording

The recorder can record up to 3 waveforms at a time. You can select, in order, **[Waveform 1]**, **[Waveform 2]** and **[Waveform 3]** in the **[Record Setup]** menu, and then select the waveforms you want. You can also turn off a waveform recording by selecting **[Off]**. These settings are intended for realtime and scheduled recordings.

29.4.3 Setting the Realtime Recording Length

After starting a realtime recording, the recording time depends on your monitor's settings. In the **[Record Setup]** menu, select **[Length]** and then select **[8 s]** or **[Continuous]**.

- **[8 s]**: record 4-second waveforms respectively before and after current moment.
- **[Continuous]**: record the waveforms from the current moment until stopped manually.

29.4.4 Setting the Interval between Timed Recordings

Timed recordings start automatically at preset intervals. Each recording lasts 8 seconds. To set the interval between timed recordings: in the **[Record Setup]** menu, select **[Interval]** and then select the appropriate setting.

29.4.5 Changing the Recording Speed

In the **[Record Setup]** menu, select **[Paper Speed]** and then select **[25 mm/s]** or **[50 mm/s]**. This setting is for all recordings containing waveforms.

29.4.6 Clearing Recording Tasks

In the **[Record Setup]** menu, select **[Clear All Tasks]**. All queued recording tasks are cleared and the current recording is stopped.

29.4.7 Setting the IBP Waveform Overlap Recordings

To switch on or off the recordings for IBP waveform overlapping:

1. Open **[Record Setup]** menu.
2. Set **[IBP Overlap]** to:
 - ◆ **[On]**: If two or more waveforms in the selected waveforms for recording are IBP waveforms, the IBP waveforms will be recorded in the overlapping format.
 - ◆ **[Off]**: IBP waveforms will be recorded normally.

29.5 Loading Paper

To load the paper:

1. Press the latch in the upper right corner of the recorder door to open it.
2. Insert a new roll into the compartment as shown below.
3. Close the recorder door.
4. Check if paper is loaded correctly and the paper end is feeding from the top.

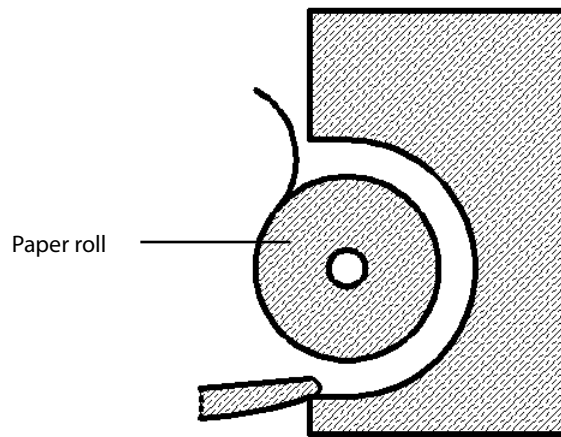

CAUTION

- **Use only specified thermal paper. Otherwise, it may cause damage to the recorder's printhead, the recorder may be unable to print, or poor print quality may result.**
 - **Never pull the recorder paper with force when a recording is in process. Otherwise, it may cause damage to the recorder.**
 - **Do not leave the recorder door open unless you are reloading paper or removing an issue.**
-

29.6 Removing Paper Jam

If the recorder works incorrectly or produces unusual sounds, check if there is a paper jam first. If a paper jam is detected, follow this procedure to remove it:

1. Open the recorder door.
2. Take out the paper and tear off the draped part.
3. Reload the paper and close the recorder door.

29.7 Cleaning the Recorder Printhead

If the recorder has been used for a long time, deposits of paper debris may collect on the printhead compromising the print quality and shortening the lifetime of the roller. Follow this procedure to clean the printhead:

1. Take measures against the static electricity such as Disposable Wrist Strap for the work.
2. Open the recorder door and take out the paper.
3. Gently wipe around the printhead using cotton swabs dampened with alcohol.
4. After the alcohol has completely dried, reload the paper and close the recorder door.

CAUTION

- **Do not use anything that may destroy the thermal element.**
 - **Do not add unnecessary force to the thermal head.**
-

30 Printing

30.1 Printer

The monitor can output patient reports via a connected printer. The monitor supports the following printers:

- HP LaserJet 1505n
- HP LaserJet P2035n
- HP LaserJet P4015n
- HP LaserJet Pro 400 M401n401dn
- HP LaserJet 600 M602
- HP LaserJet Enterprise M605
- HP LaserJet Enterprise M608n

The report specifications are:

- Paper: A4, Letter
- Resolution: 300 dpi

For more details about the printer, see the document accompanying the printer. With product upgrades, the monitor may support more printers without prior notice being given. If you have any questions or doubts about your printer, contact Mindray.

30.2 Connecting a printer

To print the reports or the trend data of a patient, you can choose either print to:

- the local printer

Connect the printer and the monitor directly with a network cable, and then start printing what you want.

- the CMS

If your monitor is connected to a CMS, it is recommended to use the CMS for printing.

30.3 Setting Up the Printer

To set the printer's properties, select **[Main Menu]**→**[Print Setup >>]**→**[Printer Setup >>]**. In the **[Printer Setup]** menu, you can:

- Select a connected printer.
Select **[Printer]** and then select a connected printer as the monitor's printer.
- Search for a printer
If your selected printer is not in the list or a new printer is added into the network, you can select the **[Search Printer]** to search for all printers in the network.
- Set up the paper
Select **[Paper Size]** and then select **[A4]** or **[Letter]**.

30.4 Starting Report Printouts

Reports	Contents	Procedures
ECG reports	ECG waveforms and relevant parameter values	Select [Main Menu] → [Print Setup >>] → [ECG Reports >>] → [Print]
QT report	QT parameter values and waveforms	Select [ECG Setup] → [QT Analysis >>] → [QT View >>] → [Print] Note: [QT Analysis] must be set to [On] .
Tabular trends	Depends on the selected parameter group, resolution and time period	Select [Main Menu] → [Print Setup >>] → [Tabular Trends Reports >>] → [Print] , or select [Main Menu] → [Review >>] → [Tabular Trends] → [Print] → [Print]
Graphic trends	Depends on the selected parameter group, resolution and time period	Select [Main Menu] → [Print Setup >>] → [Graphic Trends Reports >>] → [Print] , or select [Main Menu] → [Review >>] → [Graphic Trends] → [Print] → [Print]
Arrh. alarm review	ECG waveforms and relevant parameter values	Select [Print] in [Arrh. Events]
Parameter alarm review	Depends on the selected alarms	Select [Main Menu] → [Review >>] → [Alarms] → [Print]
Realtime waves	Depends on the selected waveforms	Select [Main Menu] → [Print Setup >>] → [Realtime Reports >>] → [Print]

30.5 Stopping Report Printouts

To stop report printouts, select **[Main Menu]**→**[Print Setup >>]**→**[Stop All Reports]**.

30.6 Setting Up Reports

30.6.1 Setting Up ECG Reports

You can print ECG reports only from the full-screen, half-screen or 12-lead monitoring screen. To set up ECG reports, select **[Main Menu]**→**[Print Setup >>]**→**[ECG Reports >>]**.

- **[Amplitude]**: set the amplitude of the ECG waveforms.
- **[Sweep]**: set the wave print speed to 25 mm/s or 50 mm/s.
- **[Auto Interval]**: if **[Auto Interval]** is set to **[On]**, the system will automatically adjust the space between waveforms to avoid overlapping.
- **[Gridlines]**: choose whether to show gridlines.
- **[12-Lead Format]**: if you select **[12×1]**, 12 waveforms will be printed on a paper from top to bottom. If you select **[6×2]**, 12 waveforms will be printed from left to right with 6 waveforms on each half and a rhythm waveform will be printed across the bottom. If you select **[3×4]**, 12 waveforms will be printed from left to right with 3 waveforms in each of the 4 columns and a rhythm waveform will be printed across the bottom.

30.6.2 Setting Up Tabular Trends Reports

To set up tabular trends reports, select **[Main Menu]**→**[Print Setup >>]**→**[Tabular Trends Reports >>]**.

- **[Start time]**: you can set a time period whose trend data will be printed out by setting **[From]** and **[Back]**. For example, if you set **[From]** as 2014-4-2 10:00:00 and **[Back]** as **[2 h]**, the outputted data will be from 2014-4-2 08:00:00 to 2014-4-2 10:00:00. In addition, the **[Back]** can be set to either:
 - ◆ **[Auto]**: if **[ReportFormat]** is set to **[Time Oriented]**, the report will be printed by time. If **[ReportFormat]** is set to **[Parameter Oriented]**, the report will be printed by parameter.
 - ◆ **[All]**: if you select **[All]**, all trend data will be printed out. In this case, there is no need to set **[From]**.
- **[Interval]**: choose the resolution of the tabular trends printed on the report.
- **[ReportFormat]**: if you select **[Time Oriented]**, the report will be printed by time. If you select **[Parameter Oriented]**, the report will be printed by parameter.
- **[Select Parameter >>]**: from the pop-up menu, you can:
 - ◆ **[Currently Displayed Trended Parameters]**: print the parameter trend data selected from the **[Tabular Trends]**.
 - ◆ **[Standard Parameter Group]**: select the standard parameter group for printing.
 - ◆ **[Custom]**: define a parameter group for printing from the parameters displayed in the lower part of the menu.

30.6.3 Setting Up Graphic Trends Reports

To set up graphic trends reports, select **[Main Menu]**→**[Print Setup >>]**→**[Graphic Trends Reports >>]**. Setting up graphic trends reports is similar with tabular trends reports. Refer to section **30.6.2** Setting Up Tabular Trends Reports for details.

30.6.4 Setting Up Realtime Reports

To set up realtime reports, select **[Main Menu]**→**[Print Setup >>]**→**[Realtime Reports >>]**.

- **[Sweep]**: set the wave print speed to 12.5 mm/s, 25 mm/s, 50 mm/s, or Auto.
- **[Select Wave >>]**: from the pop-up menu, you can:
 - ◆ **[Current]**: print the currently displayed waves.
 - ◆ **[Select Wave]**: select the desired waves for printing.

30.7 End Case Reports

ECG reports, tabular trends reports, graphic trends reports, NIBP review reports and realtime reports can be set as end case reports. When you discharge a patient, the system will automatically print all contents that are set as end case reports.

For example, to set the ECG report as an end case report:

1. Select **[Main Menu]**→**[Print Setup >>]**→**[ECG Report >>]**.
2. Select **[End Case Report]**→**[Set as End Case Report]** and then select **[Ok]** from the pop-up dialog box.
3. Set as described in section **30.6.1 Setting Up ECG Reports**.

30.8 Printer Statuses

30.8.1 Printer Out of Paper

When the printer is out of paper, the printer will not print until the paper is replaced. If there are too many print jobs that are not printed, a printer error may occur. In this case, you need to install paper and then re-send the print request. Restart the printer if necessary.

To avoid this, ensure that there is enough paper in the printer before sending a print request.

30.8.2 Printer Status Messages

Printer Status Message	Possible causes and suggested action
Printer unavailable	The selected printer is not available. Check if the printer is switched on or correctly connected or installed with paper.

31 Other Functions

31.1 Analog Output

The monitor provides analog output signals to accessory equipment via the Micro-D connector on the rear of the monitor. To obtain analog output signals, connect the accessory equipment such as an oscillograph, etc. to the monitor and then follow this procedure:

1. Select **[Main Menu]** → **[Analog Output Setup>>]**.
2. Select **[Analog Out.]** and then select **[On]**.

NOTE

- **The analog output feature is seldom applied in clinical applications. You can contact your service personnel for more details.**
-

31.2 Exporting the Log

The monitor stores system status information, including failures, abnormality, and technical alarms, into the log. You can export the log to a USB disk.

To export the log,

1. Connect a USB disk to the monitor's USB connector. See section **2.2.3 Rear View** for the proper location of the USB connector.
2. Select **[Main Menu]**→**[Maintenance >>]**→**[User Maintenance >>]**→enter the required password→**[Others >>]**.
3. Select **[Export Log]**.

31.3 Transferring Data

You can transfer the patient data saved in the monitor to a PC via a crossover network cable or CF storage card, or within a LAN for data management, for review or print.

31.3.1 Data Export System

You must install the data export system on the intended PC before performing the data transfer operation. Refer to the document accompanying the data export system installation CD-ROM for installation instructions.

The data export system supports patient management, data review, data format conversion, print, etc. in addition to data transfer. Refer to the help file of the data export system software for more details.

31.3.2 Transferring Data by Different Means

NOTE

- **Never enter the data transfer mode when the monitor is in normal operation or performs monitoring. You must re-start the monitor to exit the data transfer mode.**
-

Transfer data via a crossover network cable

Before transferring data using a crossover network cable:

1. Connect one end of the crossover network cable to the monitor and the other end to the PC.
2. Set the IP address of the PC. This IP address must be in the same network segment with that of the monitor.
3. Make sure that the data export system is active on the PC.

Then, follow this procedure to transfer data:

1. Select [**Main Menu**]→[**Patient Data >>**]→[**Transfer Data**].
2. Select [**Yes**] from the pop-up message box.
3. Input the IP address already set on the PC.
4. Select [**Start**] to start transferring data.

Transfer data within a LAN

Before transferring data within a LAN:

1. Connect the monitor and the intended PC into the same LAN and acquire the PC's IP address.
2. Make sure that the data export system is active on the PC.

Follow the same procedure as via a crossover network cable to transfer data.

Transfer data via a CF storage card

1. Power off the monitor and remove the CF storage card from it. Refer to chapter **3 Basic Operations** for details.
2. Run the data export system on the PC.
3. Insert the CF storage card into the card reader that connects the PC.
4. Perform the data transfer operation following the help file of the system software.

31.4 Nurse Call

The monitor provides a nurse call connector to output nurse call signal when a user-defined alarm occurs. To obtain nurse call signal, use the nurse call cable (**PN: 8000-21-10361**) we supply to connect the hospital nurse call system to the nurse call connector of the monitor and then follow this procedure:

1. Select **[Main Menu]**→**[Maintenance >>]**→**[User Maintenance >>]**→enter the required password.
2. Select **[Others >>]** to access the **[Others]** menu.
3. Select **[Nurse Call Setup >>]** to change the nurse call settings as follows:
 - Select **[Signal Type]** and then select **[Pulse]** or **[Continuous]**.
 - ◆ **[Pulse]**: the nurse call signal is a pulse signal and each pulse lasts one second. When multiple alarms occur simultaneously, only one pulse signal is output. If an alarm occurs but the previous one is not cleared, a new pulse signal will also be output.
 - ◆ **[Continuous]**: the nurse call signal lasts until the alarm ends, i.e. the duration of a nurse call signal is equal to that of the alarm condition.
 - Select **[Contact Type]** and then select **[Normally Open]** or **[Normally Closed]**.
 - ◆ **[Normally Open]**: select if your hospital's nurse call relay contact is normally open.
 - ◆ **[Normally Closed]**: select if your hospital's nurse call relay contact is normally closed.
 - Select **[Alm Lev]** and set the alarm level for nurse call-triggering alarms.
 - Select **[Alarm Cat.]** and then select the category to which the nurse call-triggering alarms belong.

Alarm conditions are indicated to nurses only when:

- The nurse call system is enabled,
- An alarm that meets your preset requirements occurs, and
- The monitor is not in the alarm paused or silence status.

WARNING

- **To obtain the nurse call signal, use the Mindray approved nurse call cable (PN: 8000-21-10361). Otherwise the nurse call function will not work and the monitor may be damaged.**
 - **Do not rely exclusively on the nurse call system for alarm notification. Remember that the most reliable alarm notification combines audible and visual alarm indications with the patient's clinical condition.**
-

NOTE

- **If no setting is selected from [Alm Lev] or [Alarm Cat.], no nurse call signal will be triggered whatever alarms occur.**
-

31.5 iView System (for Passport 17m only)

The iView system is a subsystem integrated in the monitor to display the PC application program window on the monitor and exchange information.

The iView system of this monitor can be configured with the Windows operating system. You can install and use the required PC application program on the monitor through the Windows operating system.

31.5.1 Start, Power off and Restart iView System

Start iView System

Select [Main Menu]→[Maintenance>>]→[User Maintenance>>]→enter the required password→[iView Maintenance>>]→[iView Start]. Then the iView system runs and the ShortCut [iView] in the main screen is enabled.

Power off iView system

Select [Main Menu]→[Maintenance>>]→[User Maintenance>>]→enter the required password→[iView Maintenance>>]→[iView Power Off], and select [Yes] in the pop-up. Then the iView system shuts down and the ShortCut [iView] in the main screen is disabled.

Restart iView System

Select [Main Menu]→[Maintenance>>]→[User Maintenance>>]→enter the required password→[iView Maintenance>>]→[iView Restart], and select [Yes] in the pop-up.

NOTE

- The Restart, Shutdown, Sleep and Hibernate operations from the [Start] menu of the configured Windows system are ineffective to the iView system. The corresponding operations have to be performed in the [iView Maintenance>>] menu.

31.5.2 Configuring Application Program ShortCuts

Select [iView] and the iView ShortCuts area is displayed. Up to five PC application program ShortCuts can be displayed in this area. You can select from these ShortCuts to use the desired application programme.

To configure the ShortCuts:

1. Select [Main Menu]→[Maintenance>>]→[User Maintenance>>]→enter the required password→[iView Maintenance>>]→[iView Maintenance].
2. To start the configuration tool, select "Config" on the desktop or select [Start]→[My Computer] in the lower left corner of the desktop. Run "Config.exe" under the path "C:\Program Files\Mindray".

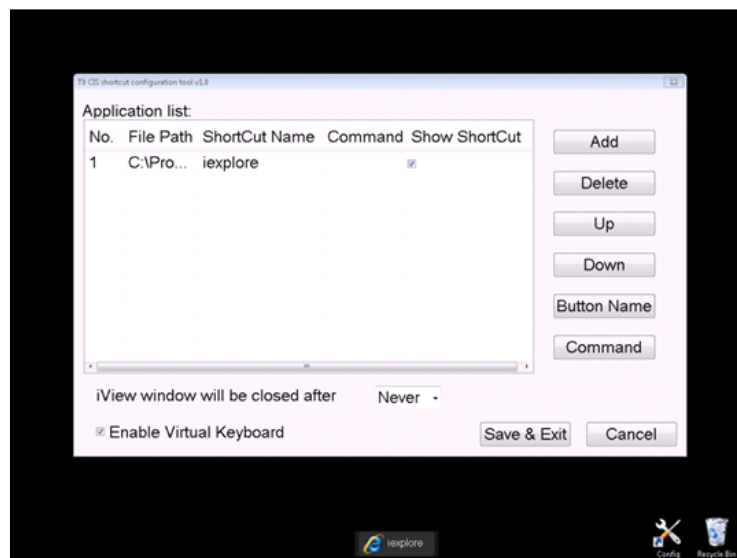

Note

- The task bar is hidden automatically and is displayed when the mouse is placed at the bottom of the screen.

3. Select **[Add]** and select the application program to be added from the accessed dialog box. Then select **[Open]** to finish adding the application program.

You can select whether to display ShortCuts. **[Show Shortcut]** is checked by default. If not selected, the application program ShortCuts will not be displayed in the iView ShortCuts area. Not selecting the checkbox usually occurs when the application program is started up indirectly. In this case, add both startup program and started program into **[T8 iView shortcut configuration tool]** and do not select the started program. For example, if you want to start the "iexplore.exe" application program to access "www.mindray.com" through the "IE.bat" batch file, write parameters into the batch file. Then add "IE.bat" and the "iexplore.exe" application programs into the **[T8 iView shortcut configuration tool]** and uncheck the "iexplore.exe" status. Finally, save the setting and exit.

4. Select **[Up]** or **[Down]** to change the display order of ShortCuts.
5. Select the cell under **[Shortcut Name]** to change the name of application program.
6. For the application program that can be started up together with the parameter, select the cell under **[Command]** to configure a parameter of the application program. For example, if you add application program "iexplore.exe" into **[T8 iView shortcut configuration tool]**, set **[Command]** to "www.mindray.com". Then in the iView ShortCuts area, select the Shortcut of "iexplore.exe" and the system enters the website "www.mindray.com".
7. Select **[Save&Exit]** to finish Shortcut configuration.
8. Select the checkbox before **[Enable Virtual Keyboard]**, and the virtual keyboard can be used after the application program runs.
9. Select **[Never]**, **[10]**, **[30]** or **[60]** in the drop-down list of **[iView window will be closed after]** to set the time interval for the system to automatically close the iView window. For example, when you set to **[10]**, if no operation in the iView window is done in 10 minutes, the iView window will automatically close.

Push the **[Main Menu]** key on the monitor front panel to return to the main screen.

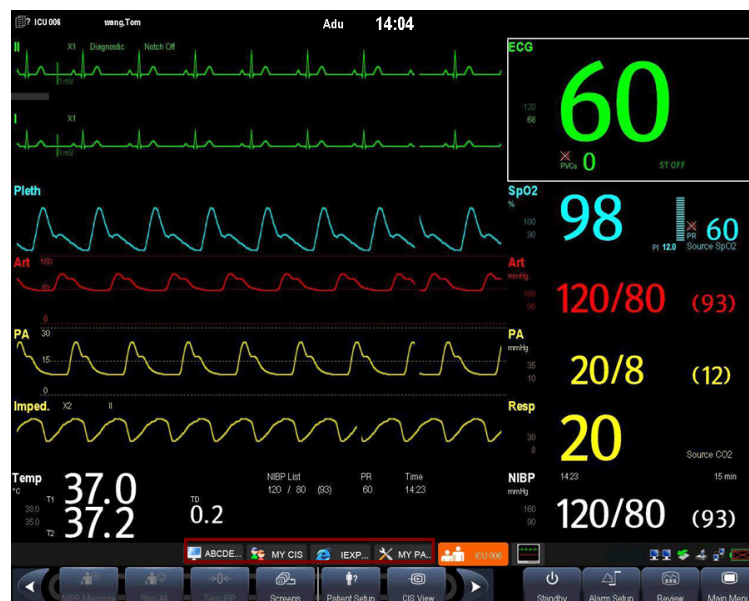

iView ShortCuts Area

31.5.3 Using PC Software

1. Select **[Main Menu]** and select **[iVew]**, or select **[iView]** on the main screen directly. The PC software ShortCuts with which your monitor is configured will be displayed.
2. Select the ShortCut corresponding to the PC software you want to use to access the corresponding software screen. Only one PC software screen can be accessed at a time.

iView ShortCuts Area is automatically hidden while the PC software is running. It is automatically displayed when the PC software display is minimized or turned off. You can adjust the size or display position of the software window via mouse.

WARNING

- **All the waveforms and parameters on the monitor are hidden when the PC software display is maximized. Pay attention to the risk arising from this operation.**
 - **Exit PC software or minimize PC software display when PC software is not in use.**
-

To hide a PC software screen:

- Select the  button in the upper right corner of the software screen.
- Select another area on the monitor screen.
- Push the **[Main Menu]** key or the **[Freeze]** key on the monitor front panel.

If PC software is open, and **[Enable Virtual Keyboard]** is checked in the **[T8 iView shortcut configuration tool]**, a

virtual keyboard icon  hides in the left corner of application window. Select the icon, the virtual keyboard will display.

31.5.4 iView Window Close and Standby

The monitor will automatically close the iView window if you have not done an operation in the iView window for a period of time, depending on the time selected for **[iView window will be closed after]**.

To re-access iView window, select the ShortCut **[iView]** in main screen.

When the monitor enters Standby, the iView system will also enter Standby.

31.5.5 Recover iView System

The USB device for iView maintenance can be used to recover the iView system.

Note

- **Use the USB device for iView maintenance under the guidance of Mindray authorized personnel. The USB device is only for Passport 17m patient monitor. Never use it on other equipment.**
-

31.5.6 Remote Login

If the monitor is networked via iView network connector, you can remotely log in to the monitor's built-in Windows system through the PC within the LAN. On the PC, you can view the program running on the monitor and perform remote maintenance. Before exiting remote login, you need to restart the monitor's Windows system. To restart the monitor's Windows system, select **[Start]**→**[Run]** on the remote PC and then enter "Shutdown -f -r -t 0".

31.5.7 Using McAfee Solidifier

McAfee Solidifier is the default installation software on iView Windows system . McAfee Solidifier consolidates the executable files of the system, dynamic link library and batch files by way of dynamic white list. Executable files not included in the white list are held back so as to protect the system. You can update the application program or monitor Windows system via the McAfee Solidifier.

To update the application program:

1. Enter update status.

Before adding, updating or deleting an application program on iView system, let McAfee Solidifier enter update status first. In this case, select "McAfee Solidifier" on the desktop to enter command line dialog box and then enter command "sadmin bu".

Note

- **Before updating an application program, pay attention to anti-virus measures such as network anti-virus strategy and USB device virus scanning.**
-

2. Enter monitor status.

After adding, updating or deleting an application program of the built-in PC, let McAfee Solidifier enter monitor status. In this case, select "McAfee Solidifier" on the desktop to enter command line dialog box and then enter command "sadmin eu".

Other commonly used commands of McAfee Solidifier include:

- sadmin help: used to view the commonly used commands;
- sadmin status: used to view the status of McAfee.

31.6 Network Setup

CAUTION

- **Disconnecting from the network may result in loss of transmitted data, including parameter waveforms and measurements, alarm events, trends and patient data, or cause function failure. In case of network disconnection, check the patient and solve the network problem as soon as possible.**
-

31.6.1 Setting the Network Type

The Passport 12m patient monitor supports both wired and wireless network. The Passport 17m patient monitor supports the wired network only.

To set the network type:

1. Select **[Main Menu]**→**[Maintenance>>]**→**[User Maintenance>>]**→enter the required password→select **[Ok]**.
2. Select **[Network Setup >>]**.
3. Select **[Monitor Network Setup >>]**.
4. Set **[Network Type]** to **[LAN]** or **[WLAN]**.

31.6.2 Wireless Network Connection (For Passport 12m Only)

31.6.2.1 Requirements for Wireless Network

To set up the wireless network, the following requirements should be met:

- The Cisco AIR-AP2802I-A-K9, AIR-CAP2602I-A-K9, or AIR-AP1242AG-A-K9, is the recommended wireless Access Point (AP). Performance cannot be guaranteed if any other wireless APs are used.
- Support the 802.11a/b/g/n wireless protocol.
- The channel bandwidth should be 20 MHz.
- WPA2-PSK security method is recommended for authentication and encryption.
- Support WPA-PSK, WPA2-PSK, WPA-Enterprise, and WPA2-Enterprise.
- The throughput capacity of each Passport 12m monitor is 2.98 Mbps for the BeneVision CMS. The total throughput of the wireless devices connected to a wireless AP should be less than the effective transmitting capability of the wireless AP. Refer to the AP manufacturer for the AP effective transmitting capability.
- Where the monitor is located, the wireless AP signal strength should be no less than -65 dBm.
- Where the monitor is located, the signal strength of other Wi-Fi devices of the same channel should be no greater than -85 dBm.
- Where the monitor is located, the signal strength of other Wi-Fi devices of adjacent channels should no greater than -50 dBm.
- The recommended distance between the monitor and other non-Wi-Fi wireless devices, including wireless devices at the frequency of 2.4GHz, cellular mobile communication networks, microwave ovens, intercoms, cordless phones and electro-surgical units, is no less than 20 cm.

CAUTIONS

- Always configure the wireless network according to local wireless regulations.
 - Authentication and encryption other than WPA2-PSK or WPA/WPA2 Enterprise may expose sensitive data and allow a malicious attack on the system.
 - Keep network authentication information, for example passwords, safe to protect the network from being accessed by unauthorized users.
 - Disconnecting from the network may result in data loss, including waveforms, numerics, alarm events, trends and patient data, or function failure. Check the patient in case of network disconnection and solve the network problem as soon as possible.
 - Do not connect non-medical devices to the wireless network.
-

31.6.2.2 Setting the Wireless Network

To set the wireless network:

1. Select **[Main Menu]**→**[Maintenance>>]**→**[User Maintenance>>]**→enter the required password→select **[Ok]**.
2. Select **[Network Setup >>]**.
3. Select **[Monitor Network Setup >>]**.
4. Set **[Network Type]** to **[WLAN]**.
5. Set the desired **[Address Type]**.
 - ◆ **[Manual]** : Indicates that the operator will manually enter network settings including IP Address, Subnet Mask, Gateway.
 - ◆ **[DHCP]**: Indicates that the monitor will automatically acquire network settings from a DHCP server.

31.6.2.3 Wireless Network Related Problems

Symptoms	Correction Action
Unable to connect the network.	<ol style="list-style-type: none"> 1. Verify that the network is available. 2. Check if the network type is correctly set. For example, if LAN is used, set the network type to LAN and connect the Passport 12m to the network; if WLAN is used, set the network type to WLAN and connect the Passport 12m to the wireless network. 3. Check that the SSID and password of the monitor are consistent with those of the wireless AP. 4. Check for IP address conflicts. If any are found, change the IP addresses to remove the conflict. 5. Check if the Mindray recommended wireless AP is used. If not, verify the AP effective transmission rate meets the throughput requirements of the connected devices. 6. Verify the AP channel bandwidth is 20 MHz. 7. Verify that where the monitor is located, the wireless AP signal strength is no less than -65 dBm. 8. Verify that where the monitor is located, the signal strength of other Wi-Fi devices on the same channel is no greater than -85 dBm. 9. Verify that where the monitor is located, the signal strength of other Wi-Fi devices on adjacent channels is no greater than -50 dBm. 10. Verify that the recommended distance between the monitor and other non-Wi-Fi wireless devices, including wireless devices at the frequency of 2.4GHz, cellular mobile communication networks, microwave ovens, intercoms, cordless phones and electro-surgical units, is no less than 20 cm.
The monitor is frequently off line or disconnects from the network. The transmission delay is too long.	<ol style="list-style-type: none"> 1. Check if the Mindray recommended wireless AP is used. If not, verify the AP effective transmission rate meets the throughput requirements of the connected devices. 2. Verify the AP channel bandwidth is 20 MHz. 3. Verify that where the monitor is located, the wireless AP signal strength is no less than -65 dBm. 4. Verify that where the monitor is located, the signal strength of other Wi-Fi devices on the same channel is no greater than -85 dBm. 5. Verify that where the monitor is located, the signal strength of other Wi-Fi devices on adjacent channels is no greater than -50 dBm. 6. Verify that the recommended distance between the monitor and other non-Wi-Fi wireless devices, including wireless devices at the frequency of 2.4GHz, cellular mobile communication networks, microwave ovens, intercoms, cordless phones and electro-surgical units, is no less than 20 cm. 7. Verify that no unauthorized devices are connected to the wireless AP.

31.6.3 Viewing the MAC Address

You can get the MAC address from the monitor for network management.

To view the MAC address:

1. Select **[Main Menu]**→**[Maintenance>>]**→**[User Maintenance>>]**→enter the required password→select **[Ok]**.
2. Select **[Network Setup >>]**.
3. Select **[Monitor Network Setup >>]**.

NOTE

- **Only the MAC address of the wired NIC is available. The wireless radio MAC address is not available.**

31.6.4 Enabling the Data Encryption

If you enable the data encryption, the patient's MRN (Medical Record Number), visit number, first name and last name are encrypted when transferring data to the CMS or eGateway.

To enable the data encryption:

1. Select **[Main Menu]**→**[Maintenance>>]**→**[User Maintenance>>]**→enter the required password→select **[Ok]**.
2. Select **[Network Setup >>]**.
3. Set **[Network Encrypt Switch]** to **[On]**.

31.6.5 Connecting the Monitor to the CMS

The Passport 12m and Passport 17m monitors can be connected to the central station (CMS) through the network. When connected with the CMS,

- ◆ The monitor transmits waveforms and numerics of parameters (e.g. ECG, Resp, Temp, SpO₂, CO₂, NIBP), related alarms and alarm settings, patients' information, operating mode, and and historical data, including trends and events, to the central station.. The waveforms, numerics, alarms, alarm settings, patients' information, operating mode, and historical data displayed on the central station are consistent with the monitor.
- ◆ When so configured, the central station can transmit alarm settings, patients' information, and operating mode settings to the monitor. The alarm settings, patients' information, and operating mode settings of the monitor are consistent with the central station.

31.6.5.1 Setting the Central Stations for Passport 12m

You can configure up to 30 central stations (CMS) for your monitor. To set the CMSs:

1. Select **[Main Menu]**→**[Maintenance >>]**→**[User Maintenance>>]**→enter the required password.→**[Network Setup >>]**→**[Central Station Setup >>]**.
2. Set CMS names and corresponding IP addresses.

Selecting a CMS

If **[Select CMS]** is enabled, you can select the central station (CMS) for the current monitoring.

To select the CMS, select the prompt message area at the bottom of the screen. Then the selected CMS name will display.

If no CMS is selected, this area displays "???".

Clearing the Selected CMS at Startup

You can clear the selected CMS each time the monitor restarts after being powered off for more than 2 minutes.

To clear the selected CMS:

- 1 Select **[Main Menu]**→**[Maintenance>>]**→**[User Maintenance>>]**→enter the required password→**[Others >>]**.
- 2 Set **[Clear CMS IP at startup]** to **[On]**.

The selected CMS will not be cleared when only one CMS is configured, or the monitor is restarted within 2 minutes.

This function is switched off by default.

31.6.5.2 Connecting the Passport 17m to the CMS

To connect a Passport 17m monitor to the CMS:

- 1 Select **[Main Menu]**→**[Maintenance>>]**→**[User Maintenance>>]**→enter the required password→**[Network Setup >>]**→**[Monitor Network Setup >>]**.
- 2 In the **[Monitor Network Setup]** menu, set **[Network Type]** and **[Address Type]**.
- 3 Input the monitor IP address, subnet mask and gateway address if the **[Address Type]** is set to **[Manual]**.
- 4 Admit a Passport 17m monitor on the CMS. Refer to the *H-046-007960-00 BeneVision CMS Ops Manual(FDA)* or *H-046-010879-00 BeneVision CMS Operator's Manual R3* for details of admitting Passport 17m.

31.6.6 Setting the Network Service Quality Level

To set the quality of service (QoS):

1. Select **[Main Menu]**→**[Maintenance>>]**→**[User Maintenance>>]**→enter the required password.→**[Network Setup >>]**→**[QoS Setup >>]**.
2. Select the desired value for **[Realtime Monitoring]**. This sets the service quality of network connection for important realtime network transactions such as parameter measurements, waveforms, and alarms. The value ranges from 0 to7. The greater the value, the higher priority the network transaction.
3. Select the desired value for **[Others]**. This sets the service quality of network connection for secondary non-realtime network transactions such as transferring historical data from the monitor to the CMS. The value ranges from 0 to7. The greater the value, the higher priority the network transaction.

31.6.7 Setting the Multicast Parameters

Multicast parameters must be configured before use on a network.

To set the multicast parameters:

1. Select **[Main Menu]**→**[Maintenance>>]**→**[User Maintenance>>]**→enter the required password.→**[Network Setup >>]**→**[Multicast Setup >>]**.
2. Set **[Multicast Addr]** and **[TTL]**.
3. Select **[Ok]** to save the setting.

31.7 MLDAP

MLDAP refers to Mindray LDAP (Lightweight Directory Access Protocol). It is an independent process which can be installed on eGateway or other application server (Windows). MLDAP provides user authorization and authentication. The MLDAP server is connected to the hospital's LDAP or ADT server. All monitoring devices are connected to the MLDAP server to perform authorization and authentication for the following operations:

- Changing alarm settings
- Changing arrhythmia settings
- Accessing the **[User Maintenance]** menu

31.7.1 Setting MLDAP

To access the MLDAP server, you should set your monitor as follows:

1. Select **[Main Menu]**→**[Maintenance>>]**→**[User Maintenance>>]**→enter the required password.→**[Network Setup >>]**→**[User Authentication Service Setup >>]**.
2. Set IP address and port of the MLDAP server.

31.7.2 Selecting Password for User Authentication

You can select what password is used when changing alarm settings, arrhythmia settings, and accessing the Maintenance menu. To select the passwords:

1. Select **[Main Menu]**→**[Maintenance>>]**→**[User Maintenance>>]**→enter the required password.→**[Password Protection >>]**.
2. Select **[Alarm Setup]** to set password for changing alarm settings.
 - ◆ **[No Password]**: changing alarm settings is not password protected.
 - ◆ **[Local Password]**: changing alarm ON/OFF switch, alarm limit, and alarm priority is password protected. The monitor's local password is required to change alarm settings.
 - ◆ **[User Password]**: changing alarm ON/OFF switch, alarm limit, and alarm priority is password protected. The user name and password saved in the MLDAP server are required to change alarm settings.
3. Select **[Arrh. Alarm Settings]** to set password for changing arrhythmia settings.
 - ◆ **[No Password]**: changing arrhythmia settings is not password protected.
 - ◆ **[Local Password]**: changing arrhythmia ON/OFF switch, alarm priority, and arrhythmia threshold is password protected. The monitor's local password is required to change arrhythmia settings.
 - ◆ **[User Password]**: changing arrhythmia ON/OFF switch, alarm priority, and arrhythmia threshold is password protected. The user name and password saved in the MLDAP server are required to change arrhythmia settings.
4. Select **[User Maintenance]** to set password for changing user maintenance settings.
 - ◆ **[Local Password]**: changing user maintenance settings is password protected. The monitor's local password is required to change user maintenance settings.
 - ◆ **[User Password]**: changing user maintenance settings is password protected. The user name and password saved in the MLDAP server are required to change user maintenance settings.

To change the monitor's local password for changing alarm settings and arrhythmia settings, select [**Modify Local Alarm Password>>**], enter the new password, and select [**OK**].

To change the monitor's local password for accessing the [**User Maintenance**] menu, select [**Modify Local User Maintenance Password>>**], enter the new password, and select [**OK**].

31.8 Using DVI-VGA Adapter Box

The monitor can be connected with a VGA device via a DVI-VGA adapter box.

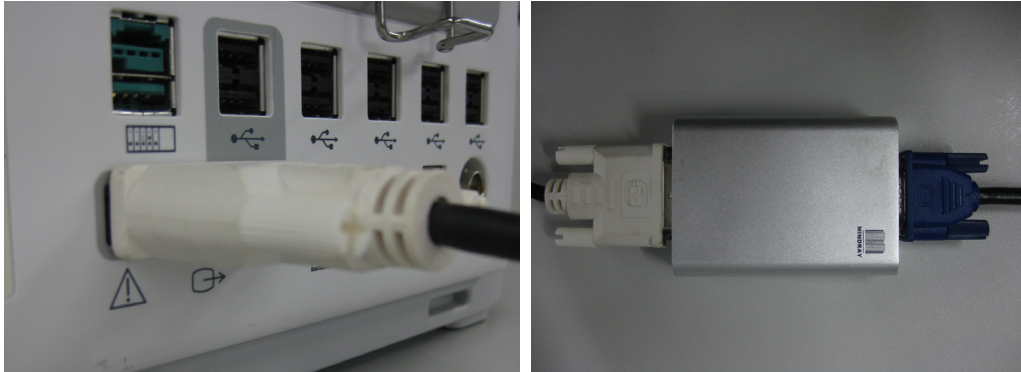

1. Connect the monitor's DVI output with DVI-VGA adapter box's DVI input.
2. Connect the DVI-VGA adapter box's VGA output with VGA device.

32 Batteries

32.1 Overview

This monitor is designed to operate from rechargeable Lithium-ion battery power when AC power is not available. It is recommended to always install fully charged batteries into the monitor to ensure normal monitoring in case of accidental power failure. If the AC power is interrupted during patient monitoring, the monitor automatically runs from the batteries.

On-screen battery symbols indicate the battery status as follows:



Indicates full battery capacity.



Indicates that the batteries work correctly. The solid portion represents the current charge level of the battery in proportion to its maximum charge level.



Indicates that the batteries have a low charge level and need to be charged.



Indicates that the batteries are almost depleted and need to be charged immediately.



Indicates that no batteries are installed or only one battery is installed to the Passport 17m monitor.

The capacity of the battery is limited. When the battery is low, the technical alarm area displays **[Low Battery]**, the alarm lamp flashes, and monitor produces an alarm sound.

If the battery is depleted, the battery symbol on the screen flashes, the technical alarm area displays **[Battery Depleted]**, the alarm lamp flashes, and the monitor produces alarm sound. Connect the equipment to AC mains to run the equipment and charge the battery. Otherwise the monitor will shut down.

32.2 Safety

CAUTION

- **Keep the battery out of children's reach.**
 - **Use only specified batteries.**
 - **Keep the batteries in their original package until you are ready to use them.**
 - **Do not expose batteries to liquid.**
 - **High ambient temperature shortens battery run time.**
 - **Extremely high ambient temperature may cause battery overheat protection, and then the monitor will turn off.**
 - **If the battery shows signs of damage or signs of leakage, replace it immediately. Do not use a faulty monitor battery.**
 - **Do not crush, drop or puncture the battery. Mechanical abuse can lead to internal damage and internal short circuits. If a battery has been dropped or banged against a hard surface, whether damage is externally visible or not, remove the battery from use and dispose of it properly.**
 - **Please replace your battery when it reaches the end of its service life. Failure to replace the battery may cause serious damage to your device from battery overheating.**
-

NOTE

- **Charge the batteries in the monitor.**
 - **Use AC power supply when iView is in use.**
-

32.3 Battery Guidelines

Battery life expectancy depends on how frequent and how long it is used. For a properly maintained and stored lithium ion battery, its life expectancy is about 3 years. For more aggressive use models, life expectancy can be less. We recommend replacing lithium ion batteries after 500 full charge/discharge cycles or every 3 years from first use, whichever occurs first.

To get the most out of the battery, observe the following guidelines:

- The battery performance test must be performed every six months, before monitor repairs, or whenever poor battery performance is suspected.
- Condition the batteries regularly to maintain their useful life. For details, refer to **32.6 Conditioning a Battery**.
- Remove the battery before the monitor is shipped or will not be used for more than two weeks. Leaving the battery in a monitor that is not in regular use will shorten the life of the battery.

- The shelf life of a lithium ion battery is about 6 months when the battery is stored with the battery power being 50% of the total power. In 6 months the battery power must be depleted before the Lithium Ion battery is fully charged. Then run the monitor on this fully charged battery .When its battery power becomes 50% of the total power, take out the battery from the monitor and store it.
- Store batteries properly. For details, refer to **32.8 Storing a Battery**.

32.4 Installing or Replacing a Battery

Passport 12m

When the monitor uses two battery packs, one battery pack can easily be exchanged while the monitor operates from the other. If the monitor uses one battery pack, you should insert a new battery pack before the old one depletes.

To install or replace a battery:

1. Push down the button on the battery door and then slide backward as indicated to open the battery door.

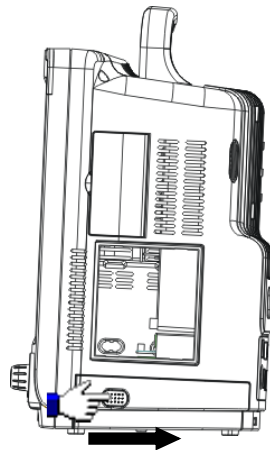

2. Push aside the latch securing the battery and then remove the battery.
3. Place the new battery into the slot.
4. If necessary, replace the other battery following the steps above.
5. Restore the latch to the original position and close the battery door.

NOTE

- **Using two batteries are recommended when a SMR is connected.**

Passport 17m

The monitor uses two battery packs. If the two batteries have different charge capacity, the message [**Diff. Battery Voltages**] is displayed. In this case, apply AC power to the monitor until the two batteries have approximately equal charge capacity or are both fully charged. You cannot use them before they have approximately equal charge capacity or are fully charged. In situations where no patient monitoring is being performed or interrupting the patient monitoring is permitted, you can replace the batteries.

When the monitor is operating on battery power, make sure the monitor is powered off before replacing a battery.

The monitor uses two batteries. You can install the batteries by following this procedure:

1. Turn off the patient monitor and disconnect the power cord and other cables.
2. Place the monitor with its face up.
3. Open the battery compartment door.

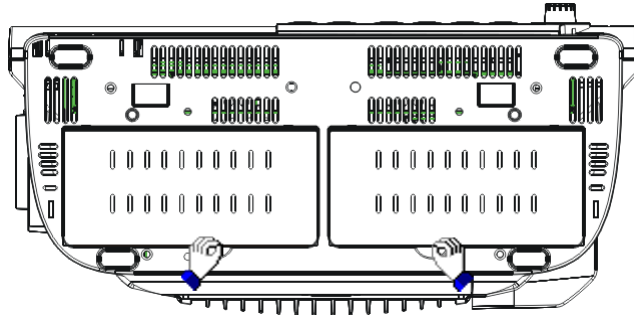

4. Place the batteries into the slots.
5. Close the battery door and place the monitor upright.

32.5 Charging a Battery

To optimize performance, a fully (or nearly fully) discharged battery should be charged as soon as possible. The battery is charged regardless of whether or not the monitor is currently turned on.

To charge the battery:

1. Install the battery in the monitor
2. Connect the monitor with the AC power source.

When the battery is charging, the AC power indicator and battery indicator are both on. If the monitor is powered on, the battery status symbol on the monitor screen displays  when the charging is complete.

32.6 Conditioning a Battery

The performance of rechargeable batteries may deteriorate over time. If a battery is not conditioned for a prolonged time, its charge indication may not be accurate and you may wrongly evaluate the remaining battery runtime. Keeping the battery continuously fully charged without conditioning will speed up battery aging and shorten its life time. You should condition a battery every three months, before it is used for the first time, or when its run time becomes noticeably shorter.

A battery conditioning cycle is one uninterrupted charge of the battery, followed by an uninterrupted battery discharge and charge.

NOTE

- **The battery charge level indicator does not indicate the capacity or operating time of the battery. It only indicates the current battery charge level. The actual battery capacity decreases over time with the use of the battery. For an old battery, its capacity and operating time may not fulfill battery specifications even when the battery charge level indicates the battery is fully charged. Please replace the battery if its operating time is significantly lower than the specified time.**
-

To condition a battery:

1. Disconnect the monitor from the patient and stop all monitoring and measuring procedures.
2. Insert the battery to be conditioned in the monitor battery slots.
3. Apply AC power to the monitor and allow the battery to charge uninterruptedly for 10 hours.
4. Remove AC power and allow the monitor to run from the battery until it shuts off.
5. Apply AC power again to the monitor and allow the battery to charge uninterruptedly for 6 hours.
6. This battery is now conditioned and the monitor can be returned to service.

CAUTION

- **Do not use the monitor to monitor the patient during battery conditioning.**
-

NOTE

- **Do not interrupt battery conditioning.**
-

32.7 Checking Battery Performance

The performance of a rechargeable battery will deteriorate over time. The battery performance test should be performed every six months, before monitor repairs, or whenever the battery performance is diminished. To check the battery performance:

1. Disconnect the monitor from the patient and stop all monitoring and measuring procedures.
2. Turn off the monitor.
3. Apply AC power to the monitor and allow the battery to charge uninterruptedly for 6 hours.
4. Remove AC power and allow the monitor to run from the battery until it shuts off.
5. Record the battery operating time.

The battery operating time directly reflects its performance. If the operating time of a battery is noticeably shorter than that stated in the specifications, replace the battery or contact the Mindray service personnel.

NOTE

- **Battery operating time depends on the device configuration and operation. For example, high display brightness or measuring NIBP repeatedly will shorten the battery operating time.**
-

32.8 Storing a Battery

When storing batteries, make sure that the battery terminals do not come into contact with metallic objects. If batteries are stored for an extended period of time, they should be placed in a cool place with a partial charge of 40% to 60% capacity.

Stored batteries should be conditioned every 6 months. Refer to section **32.6 Conditioning a Battery** for details.

NOTE

- **Remove the battery from the equipment if the equipment is not used for a prolonged period of time (for example, several weeks). Otherwise the battery may be over discharged and damaged.**
 - **Storing batteries at high temperature for an extended period of time will significantly shorten their life expectancy.**
 - **Storing batteries in a cool place will slow the aging process. Ideally the batteries should be stored at 15 °C. Do not store the batteries in an environment above 60 °C or lower than -20 °C.**
-

32.9 Recycling a Battery

Remove the old battery from the monitor and recycle it properly. Follow local laws for proper battery disposal.

WARNING

- **Do not open batteries, heat above 60 °C, incinerate batteries, or short the battery terminals. They may ignite, explode, leak, or heat up, causing personal injury.**
-

33 Care and Cleaning

33.1 General Points

In this chapter we only describe cleaning and disinfection of the main unit, modules, satellite module rack (SMR) and certain accessories. For the cleaning and disinfection of other reusable accessories, refer to instructions for use of the corresponding accessories.

Keep your equipment and accessories clean. To avoid damage to the equipment, follow these guidelines:

- Always follow the manufacturer's instructions for each cleaning / disinfecting agent.
- Do not immerse any part of the equipment or accessories into liquid.
- Do not pour liquid onto the equipment or accessories.
- Do not allow liquid to enter the case.
- Never use abrasive materials (such as steel wool or silver polish), or erosive cleaners (such as acetone or acetone-based cleaners).

WARNING

- **Be sure to turn off the system and disconnect all power cables from the outlets before cleaning the equipment.**
-

CAUTION

- **If you spill liquid on the equipment or accessories, contact Mindray or your service personnel.**
 - **Avoid wetting the pins and metal parts of the main unit, modules, SMR or accessories during cleaning and disinfection.**
 - **Use only Mindray approved cleaners and disinfectants and methods listed in this chapter to clean or disinfect your equipment. Warranty does not cover damage caused by unapproved substances or methods.**
 - **We make no claims regarding the efficacy of the listed chemicals or methods as a means for controlling infection. For the method to control infection, consult your hospital's Infection Control Officer or Epidemiologist.**
 - **The responsible hospital or institution shall carry out all cleaning and disinfection procedures specified in this chapter.**
 - **Refer to the respective instructions for use of the cleaning agents and disinfectants.**
 - **Do not mix disinfecting solutions (such as bleach and ammonia) as hazardous gases may result.**
-

NOTE

- **To clean or disinfect reusable accessories, refer to the instructions delivered with the accessories.**
-

33.2 Cleaning and Disinfecting the Main Unit/Module/SMR



33.2.1 Approved Cleaning and Disinfecting Agents

The following table lists approved cleaning and disinfecting agents:

Product Name	Product Type	Active Ingredients
Sodium hypochlorite bleach *	Liquid	Sodium hypochlorite bleach 0.5%
Hydrogen peroxide*		Hydrogen peroxide 3%
Isopropanol*		Isopropanol 70%
1-Propanol*		1-Propanol 50%
Metrex CaviCide1™		Diisobutylphenoxyethoxyethyl dimethyl benzyl ammonium chloride 0.28%, Isopropanol 17.2%
Virex® II 256		Didecyl dimethyl ammonium chloride 8.704%, n-Alkydimethyl benzyl ammonium chloride 8.190%
Virex® TB		n-Alkyl dimethyl benzyl ammonium chlorides 0.105%, n-Alkyl dimethyl ethylbenzyl ammonium chlorides 0.105%
Rely+On™ Virkon® Powder *(Used as 1% solution)	Powder	Used as 1% solution Biocidal active: Pentapotassium bis (peroxymonosulphate) bis (sulphate)(500g/kg), Contains dipotassium peroxodisulphate.
*Perform® Classic Concentrate OXY, 0.5%		Bactericidal 0.5% (5 g/l) Fungicidal 1% (10 g/l) Sporicidal 1% (10 g/l) Enveloped virucidal (BVDV, Vaccinia) * 0.5% (5 g/l)
Alpet® D2 Surface Sanitizing Wipes	Wipes	Isopropyl Alcohol 58.6000%, Octyl Decyl Dimethyl Ammonium chloride 0.0075%, Dioctyl Dimethyl Ammonium Chloride 0.0030%
Clorox Dispatch® Hospital Cleaner Disinfectant Towels with Bleach		Sodium Hypochlorite 0.65%
Clorox Healthcare® Bleach Germicidal Wipes		Sodium Hypochlorite 0.55%
Clorox Healthcare® Hydrogen Peroxide Cleaner Disinfectant Wipes		Hydrogen Peroxide 1.4%
Diversey Oxivir® TB Wipes		Hydrogen Peroxide 0.5%
Metrex CaviWipes™		Diisobutylphenoxyethoxyethyl dimethyl benzyl ammonium chloride 0.28%, Isopropanol 17.2%
PDI Sani-Cloth® AF3 Germicidal Disposable Wipe	Wipes	n-Alkyl dimethyl ethylbenzyl ammonium chlorides 0.14%, n-Alkyl dimethyl benzyl ammonium chlorides 0.14%
PDI Sani-Cloth® Bleach Germicidal Disposable Wipe		Sodium Hypochlorite 0.63%, other ingredients 99.37%

Product Name	Product Type	Active Ingredients
PDI Sani-Cloth [®] HB Germicidal Disposable Wipe		n-Alkyl dimethyl ethylbenzyl ammonium chlorides 0.07%, n-Alkyl dimethyl benzyl ammonium chlorides 0.07%
PDI Sani-Cloth [®] Plus Germicidal Disposable Cloth	Wipes	n-Alkyl dimethyl ethylbenzyl ammonium chlorides 0.125%, n-Alky dimethyl benzyl ammonium chlorides 0.125%
PDI Super Sani-Cloth [®] Germicidal Disposable Wipe		n-Alkyl dimethyl ethylbenzyl ammonium chlorides 0.25%, n-Alkyl dimethyl benzyl ammonium chlorides 0.25%, Isopropyl Alcohol 55.0%,
VIRAGUARD Hospital Surface Disinfectants		Isopropanol 70%,Other ingredients 30%

NOTE

- For equipment with the symbol , all the listed cleaning and disinfecting agents are available for use.
- For equipment without the symbol , only the cleaning and disinfecting agents marked with "*" are available for use.

33.2.2 Cleaning the Main Unit/Module/SMR

Your equipment should be cleaned on a regular basis. Before cleaning the equipment, consult your hospital's regulations for cleaning the equipment.

To clean your equipment, follow this procedure:

- Shut down the monitor and disconnect it from the AC power.
- Clean the display screen with wipes or a soft cloth moistened with one of the cleaning agents listed in **33.2.1 Approved Cleaning and Disinfecting Agents** only.
- Clean the exterior surface of the equipment, module or SMR with wipes or a soft cloth moistened with one of the cleaning agents listed in **33.2.1 Approved Cleaning and Disinfecting Agents** only.
- Wipe off all the cleaning agent residue with a dry cloth.
- Dry your equipment in a ventilated, cool place.

33.2.3 Disinfecting the Main Unit/Module/SMR

Disinfect the equipment as required in your hospital's servicing schedule using the disinfecting agents listed in the table above. Cleaning equipment before disinfecting is recommended.

CAUTION

- Never use EtO or formaldehyde for disinfection.

33.3 Cleaning and Disinfecting the Accessories

For the NIBP air hose, Masimo SpO₂ cable, Nellcor SpO₂ cable and NMT accessories, you should clean and disinfect them using the cleaners and disinfectants and methods listed in this section. For other accessories, you should consult the instructions delivered with the accessories.

CAUTION

- **Fluids entering the NIBP air hose can damage the equipment. When cleaning and/or disinfecting the NIBP air hose, prevent liquid from entering the hose.**
- **Periodically inspect the NIBP air hose and connector for signs of wear or deterioration. Replace the NIBP air hose if you detect a leak. Dispose of damaged NIBP air hose according to local laws for disposal of hospital waster.**
- **Never immerse or soak the accessories in any liquid.**
- **Never clean or disinfect the metallic connectors at either end of the accessories.**
- **Use only Mindray approved cleaners and disinfectants and methods listed in this section to clean or disinfect the accessories. Warranty does not cover damage caused by unapproved substances or methods.**
- **To avoid long term damage, the accessories should be disinfected only when necessary as determined by your hospital's policy.**

33.3.1 Approved Accessories Cleaning and Disinfecting Agents

The following table lists approved NIBP air hose cleaning and disinfecting agents:

Product Name	Product Type	Active Ingredients
Isopropanol	Liquid	Isopropanol 70%
1-Propanol		1-Propanol 50%
Metrex CaviCide1™		Diisobutylphenoxyethoxyethyl dimethyl benzyl ammonium chloride 0.28%, Isopropanol 17.2%
Virex® TB		n-Alkyl dimethyl benzyl ammonium chlorides 0.105%, n-Alkyl dimethyl ethylbenzyl ammonium chlorides 0.105%
Rely+On™ Virkon® Powder (Used as 1% solution)	Powder	Used as 1% solution Biocidal active: Pentapotassium bis (peroxymonosulphate) bis (sulphate) (500g/kg), Contains dipotassium peroxodisulphate 1%
Alpet® D2 Surface Sanitizing Wipes	Wipes	Isopropyl Alcohol 58.6000%, Octyl Decyl Dimethyl Ammonium chloride 0.0075%, Dioctyl Dimethyl Ammonium Chloride 0.0030%

Product Name	Product Type	Active Ingredients
Clorox Dispatch [®] Hospital Cleaner Disinfectant Towels with Bleach	Wipes	Sodium Hypochlorite 0.65%
Metrex CaviWipes [™]		Diisobutylphenoxyethoxyethyl dimethyl benzyl ammonium chloride 0.28%, Isopropanol 17.2%
PDI Sani-Cloth [®] AF3 Germicidal Disposable Wipe		n-Alkyl dimethyl ethylbenzyl ammonium chlorides 0.14%, n-Alkyl dimethyl benzyl ammonium chlorides 0.14%
PDI Sani-Cloth [®] Plus Germicidal Disposable Cloth		n-Alkyl dimethyl ethylbenzyl ammonium chlorides 0.125%, n-Alkyl dimethyl benzyl ammonium chlorides 0.125%
PDI Super Sani-Cloth [®] Germicidal Disposable Wipe		n-Alkyl dimethyl ethylbenzyl ammonium chlorides 0.25%, n-Alkyl dimethyl benzyl ammonium chlorides 0.25%, Isopropyl Alcohol 55.0%,
VIRAGUARD Hospital Surface Disinfectants		Isopropanol 70%, Other ingredients 30%

The following table lists approved Masimo SpO₂ cable cleaning and disinfecting agents:

Product Name	Product Type	Ingredients
Isopropanol	Liquid	Isopropanol 70%

The following table lists approved Nellcor SpO₂ cable cleaning and disinfecting agents:

Product Name	Product Type	Ingredients
Sodium hypochlorite bleach	Liquid	Sodium hypochlorite bleach 0.5%
Isopropanol		Isopropanol 70%
1-Propanol		1-Propanol 50%
Virex [®] TB		n-Alkyl dimethyl benzyl ammonium chlorides 0.105%, n-Alkyl dimethyl ethylbenzyl ammonium chlorides 0.105%
Rely+On [™] Virkon [®] Powder (Used as 1% solution)	Powder	Used as 1% solution Biocidal active: Pentapotassium bis (peroxymonosulphate) bis (sulphate) (500g/kg), Contains dipotassium peroxodisulphate 1%
Clorox Dispatch [®] Hospital Cleaner Disinfectant Towels with Bleach	Wipes	Sodium Hypochlorite 0.65%
Clorox Healthcare [®] Bleach Germicidal Wipes		Sodium Hypochlorite 0.55%
Clorox Healthcare [®] Hydrogen Peroxide Cleaner Disinfectant Wipes		Hydrogen Peroxide 1.4%
Diversey Oxivir [®] TB Wipes		Hydrogen Peroxide 0.5%
PDI Super Sani-Cloth [®] Germicidal Disposable Wipe		n-Alkyl dimethyl ethylbenzyl ammonium chlorides 0.25%, n-Alkyl dimethyl benzyl ammonium chlorides 0.25%, Isopropyl Alcohol 55.0%,

Product Name	Product Type	Ingredients
VIRAGUARD Hospital Surface Disinfectants		Isopropanol 70%, Other ingredients 30%

The following table lists approved NMT accessory cleaning and disinfecting agents:

Product Name	Product Type	Ingredients
Sodium hypochlorite bleach	Liquid	Sodium hypochlorite bleach 0.5%
Isopropanol		Isopropanol 70%
1-Propanol		1-Propanol 50%
Metrex CaviCide1™		Diisobutylphenoxyethoxyethyl dimethyl benzyl ammonium chloride 0.28%, Isopropanol 17.2%
Virex® TB		n-Alkyl dimethyl benzyl ammonium chlorides 0.105%, n-Alkyl dimethyl ethylbenzyl ammonium chlorides 0.105%
Rely+On™ Virkon® Powder (Used as 1% solution)	Powder	Used as 1% solution Biocidal active: Pentapotassium bis (peroxymonosulphate) bis (sulphate) (500g/kg), Contains dipotassium peroxodisulphate 1%
Alpet® D2 Surface Sanitizing Wipes	Wipes	Isopropyl Alcohol 58.6000%, Octyl Decyl Dimethyl Ammonium chloride 0.0075%, Dioctyl Dimethyl Ammonium Chloride 0.0030%
Clorox Dispatch® Hospital Cleaner Disinfectant Towels with Bleach		Sodium Hypochlorite 0.65%
Clorox Healthcare® Bleach Germicidal Wipes		Sodium Hypochlorite 0.55%
Clorox Healthcare® Hydrogen Peroxide Cleaner Disinfectant Wipes		Hydrogen Peroxide 1.4%
Diversey Oxivir® TB Wipes		Hydrogen Peroxide 0.5%
Metrex CaviWipes™		Diisobutylphenoxyethoxyethyl dimethyl benzyl ammonium chloride 0.28%, Isopropanol 17.2%
PDI Sani-Cloth® AF3 Germicidal Disposable Wipe		n-Alkyl dimethyl ethylbenzyl ammonium chlorides 0.14%, n-Alkyl dimethyl benzyl ammonium chlorides 0.14%
PDI Sani-Cloth® Bleach Germicidal Disposable Wipe		Sodium Hypochlorite 0.63%, other ingredients 99.37%
PDI Sani-Cloth® Plus Germicidal Disposable Cloth		n-Alkyl dimethyl ethylbenzyl ammonium chlorides 0.125%, n-Alkyl dimethyl benzyl ammonium chlorides 0.125%
PDI Super Sani-Cloth® Germicidal Disposable Wipe		n-Alkyl dimethyl ethylbenzyl ammonium chlorides 0.25%,

Product Name	Product Type	Ingredients
VIRAGUARD Hospital Surface Disinfectants		n-Alkyl dimethyl benzyl ammonium chlorides 0.25%, Isopropyl Alcohol 55.0%,
		Isopropanol 70%, Other ingredients 30%

33.3.2 Cleaning the Accessories

You should clean the accessories (NIBP air hose, Masimo SpO₂ cable, Nellcor SpO₂ cable and NMT accessories) on a regular basis. Before cleaning the accessories, consult your hospital's regulations for cleaning the accessories.

To clean the accessories (NIBP air hose, Masimo SpO₂ cable, Nellcor SpO₂ cable and NMT accessories), follow this procedure:

1. Clean the accessories with wipes or a soft cloth moistened with one of the cleaning agents listed in **33.3.1 *Approved Accessories Cleaning and Disinfecting Agents*** only.
2. Wipe off all the cleaning agent residue with a dry cloth.
3. Allow the accessories to air dry.

33.3.3 Disinfecting the Accessories

We recommend that the accessories (NIBP air hose, Masimo SpO₂ cable, Nellcor SpO₂ cable and NMT accessories) should be disinfected only when necessary as determined by your hospital's policy, to avoid long term damage to the accessories. Cleaning the accessories before disinfecting is recommended.

33.4 Sterilization

Sterilization is not recommended for this equipment, related products, accessories, or supplies unless otherwise indicated in the Instructions for Use that accompany the products, accessories or supplies.

FOR YOUR NOTES

34 User Maintenance

CAUTION

- **Failure on the part of the responsible individual hospital or institution using this equipment to implement a recommended maintenance schedule may cause undue equipment failure and possible health hazards.**
 - **The safety checks or maintenance involving any disassembly of the equipment should be performed by professional servicing personnel. Otherwise, undue equipment failure and possible health hazards could result.**
 - **No modification of this equipment is allowed.**
 - **Do not open the equipment housings. All servicing and future upgrades must be carried out by the service personnel trained and authorized by Mindray only.**
 - **If you discover a problem with any of the equipment, contact your service personnel or Mindray.**
 - **The service personnel must be properly qualified and thoroughly familiar with the operation of the equipment.**
-

34.1 General Inspection

A thorough inspection should be performed by qualified service personnel to ensure the reliability before first use, after your monitor has been used for 12 months, or whenever your monitor is repaired or upgraded.

Follow these guidelines when inspecting the equipment:

- Make sure that the environment and power supply meet the specifications.
- Inspect the equipment and its accessories for mechanical damage.
- Inspect all power cords for damage, and make sure that their insulation is in good condition.
- Make sure that only specified accessories are applied.
- Inspect if the alarm system functions correctly.
- Make sure that the recorder functions correctly and the recorder paper meets the specifications.
- Make sure that the batteries meet the performance specifications.
- Make sure that the monitor is in good working condition.

In case of any damage or abnormality, do not use the monitor. Contact the hospital's biomedical engineers or your service personnel immediately.

34.2 Maintenance and Testing Schedule

The following maintenance and tests, except for visual inspection, power on test, touchscreen calibration, battery check, ECG calibration, NIBP leakage, CO₂ leakage, AG leakage, and recorder check, should be carried out by the service personnel only. Ensure the monitor is safe and the performance tested by qualified service personnel before initial installation, after upgrade, or during regular scheduled maintenance. Contact your service personnel if any maintenance is required. Make sure to clean and disinfect the equipment before any test and maintenance.

CAUTION

- **Changing the settings in [User Settings >>] and [Factory Maintenance >>] menus may cause data loss.**
- **Service personnel should acquaint themselves with the test tools and make sure that the test tools and cables are applicable.**

Check/Maintenance Item		Recommended Frequency
Performance Tests		
Visual inspection		When first installed or reinstalled.
ECG test	Performance test	<ol style="list-style-type: none"> 1. If the user suspects that the measurement is incorrect. 2. Following any repairs or replacement of relevant module. 3. At least once every two years. <p>Note: At least once a year is recommended for NIBP, CO₂NMT and AG.</p>
	Verification	
Resp performance test		
SpO ₂ test		
NIBP test	Pressure check	
	Leakage test	
Temp test		
IBP performance test		
C.O. test		
Sidestream and Microstream CO ₂ tests and calibration	Leakage test	
	Performance test	
	Calibration	
AG test	Leakage test	
	Performance test	
	Calibration	
BIS test		
RM test		
CCO/SvO ₂ test	Interconnecting function	
	Output calibration	
NMT test	Performance test	
	Sensor Check	
ScvO ₂ test		
Nurse call relay performance test		If the user suspects that the analog output does not work well.
Analog output performance test		

Check/Maintenance Item		Recommended Frequency
Electrical Safety Tests		
Electrical safety test		At least once every two years
Other Tests		
Power on test		1. When first installed or reinstalled. 2. Following any maintenance or the replacement of any main unit parts.
Touchscreen calibration		1. When the touchscreen appears abnormal. 2. After the touchscreen is replaced.
Recorder check		Following any repair or replacement of the recorder.
Network print test		1. When first installed. 2. Whenever the printer is serviced or replaced.
Device integration check		1. When first installed. 2. Following any repair or replacement of the external device.
Battery check	Functionality test	1. When first installed. 2. Whenever a battery is replaced.
	Performance test	Once a year or if the battery run time reduced significantly.

34.3 Checking Monitor and Module Information

To view the information about system start time, selftest, etc., select **[Main Menu]→[Maintenance >>]→[Monitor Information >>]**. You can print out the information for the convenience of troubleshooting. The information will not be saved during shut down.

You can also view the information about the monitor configuration and system software version by selecting **[Main Menu]→[Maintenance >>]→[Software Version >>]**.

34.4 ECG Verification

The ECG signal may be inaccurate due to hardware or software problems. As a result, the ECG wave amplitude becomes greater or smaller. In that case, you need to verify the ECG module.

1. Select the ECG parameter window or waveform area→**[Filter]→[Diagnostic]**.
2. Select **[Main Menu]→[Maintenance >>]→[User Maintenance >>]**→enter the required password→**[Module Maintenance >>]→[Calibrate ECG]**. A square wave appears on the screen and the message **[ECG Calibrating]** is displayed.
3. Compare the amplitude of the square wave with the wave scale. The difference should be within 5%.
4. After the verification is completed, select **[Stop Calibrating ECG]**.

You can print the square wave and wave scale and then measure the difference between them if necessary. If the difference exceeds 5%, contact your service personnel.

34.5 NIBP Leakage Test

The NIBP leakage test checks the integrity of the system and of the valve. It is required at least once a year or when you doubt the measured NIBP. If the test failed, corresponding prompt messages will be given. If no message is displayed, it means no leakage is detected.

Tools required:

- An adult cuff
- Air tubing
- A correct sized cylinder

To perform a leakage test:

1. Set the patient category to **[Adu]**.
2. Connect the cuff to the NIBP connector on the monitor.
3. Wrap the cuff around the cylinder as shown below.

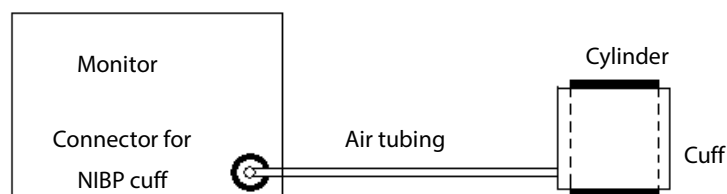

4. Select **[Main Menu]**→**[Maintenance >>]**→**[User Maintenance >>]**. Enter the required password and then select **[OK]**.
5. Select **[Module Maintenance >>]**→**[NIBP Leakage Test]**. The NIBP display shows **[Leakage Testing...]**.

After about 20 seconds, the monitor will automatically deflate. This means the test is completed. If the message **[NIBP Pneumatic Leak]** is displayed, it indicates that the NIBP airway may have leakages. Check the tubing and connections for leakages. If you ensure that the tubing and connections are all correct, perform a leakage test again.

If the problem persists, contact your service personnel.

NOTE

-
- **The leakage test is intended for use to simply determine whether there are leakages in the NIBP airway. It is not the same as that specified in the EN 1060-3 standard.**
-

34.6 CO₂ Leakage Test

For sidestream and microstream CO₂ modules, leakage test is needed every year or when you suspect the measurement.

To perform this test:

1. Connect the CO₂ module with the patient module.
2. Wait until CO₂ warmup is finished and then use your hand or other objects to completely block the gas inlet of the module or watertrap. The sidestream and microstream CO₂ modules will behave as follows:
 - ◆ Sidestream: The alarm message [**CO₂ FilterLine Err**] is displayed on the screen after certain time. Block the gas inlet for another 30 s. If the alarm message does not disappear, it indicates that the module does not leak.
 - ◆ Microstream: The alarm message [**CO₂ Purging**] is displayed on the screen after certain time. Block the gas inlet for another 30s. If alarm message [**CO₂ FilterLine Err**] is shown, it indicates that the module does not leak.

34.7 AG Leakage Test

The AG leakage test is required before every AG measurement. Follow this procedure to perform the test:

1. Plug the AG module into the module rack.
2. Wait until the AG module warmup is finished, and then use your hand or other objects to completely block the gas inlet of the AG module. An alarm message [**AG Airway Occluded**] will appear on the screen.
3. Block the gas inlet for 60 s. Select [**Main menu**]→[**Maintenance >>**]→[**User Maintenance >>**]→enter the required password→[**Module Maintenance >>**]→[**Calibrate AG >>**], and check that current flow rate is less than 10ml/min.

If the flow rate is less than 10ml/min and the alarm message [**AG Airway Occluded**] remain displayed, it indicates that the module does not leak.

If the alarm message does not appear, or the flow rate is greater than or equal to 10ml/min, it indicates that the module leaks. If the problem remains, contact your service personnel for help.

34.8 Checking NMT Sensor

NMT sensor check is required once a year or when you doubt the measured values.

To check the NMT transducer,

1. Select [**Main Menu**]→[**Maintenance >>**]→[**User Maintenance >>**]→ enter the required password→[**Module Maintenance >>**]→[**NMT Sensor Check >>**].
2. Follow the on-screen instructions to check the NMT sensor in four ways.

If sensor check completes successfully, the message "Test passed. The function of NMT sensor is OK" is presented. If any of the four steps fails, check if the sensor is placed correctly as instructed, and perform the sensor check again. Replace



the sensor or contact your service personnel if you cannot pass the sensor check.

NOTE

- **Stop NMT measurement or calibration before starting the NMT sensor check.**
 - **Take care when handling the the NMT sensor, avoiding rough impact.**
-

34.9 Calibrating the Touchscreen

To calibrate the touchscreen:

1. Select **[Main Menu]**→**[Maintenance >>]**→ **[Cal. Touchscreen]**.The  symbol will appear at different positions of the screen.
2. Select each  as it appears on the screen.
3. After the calibration is completed, the message **[Screen Calibration Completed!]** is displayed. Select **[Ok]** to confirm the completion of the calibration.

35 Accessories

The accessories listed in this chapter comply with the requirements of IEC 60601-1-2 when in use with the patient monitor. The accessory material that contacts the patients has undertaken the bio-compatibility test and is verified to be in compliance with ISO 10993-1. For details about the accessories, refer to the instructions for use provided with the accessory.

WARNING

- **Use accessories specified in this chapter. Using other accessories may cause damage to the patient monitor or not meet the claimed specifications.**
 - **Single-use accessories are not designed to be reused. Reuse may cause a risk of contamination and affect the measurement accuracy.**
-

CAUTION

- **Check the accessories and their packages for any sign of damage. Do not use them if any damage is detected.**
 - **Use the accessories before the expiry date if their expiry date is indicated.**
 - **The disposable accessories shall be disposed of according to hospital's regulations.**
-

NOTE

- **This manual describes all the accessories that are validated for use. Not all accessories are available in every market.**
-

35.1 ECG Accessories

ECG Electrodes

Model	Part No.	Description	Patient category
31499224	0010-10-12304	ECG electrode, Covidien, 10 pieces	Adult
2245-50	9000-10-07469	ECG electrode, 3M, (package of 50)	Pediatric
/	0681-00-0098-01	Radio Opaque, Pre-wired, 3-lead ECG electrodes, AHA, 18" (45.7 cm), 3 pcs/pack, 100 packs/box	Neonate
/	0681-00-0098-02	Radio Translucent, Pre-wired, 3-lead ECG electrodes, AHA, 18" (45.7 cm), 3 pcs/pack, 100 packs/box	Neonate

ECG Cables

Model	PN	Description	Applicable patient
EV6222	040-000754-00	ECG cable, 12-pin, 3-lead, defibrillation-proof, DIN connector	Neonate, infant
EV6201	0010-30-42719	ECG cable, 12-pin, 3/5-lead, defibrillation-proof, AHA/IEC	Adult, pediatric
EV6202	0010-30-42720	ECG cable, 12-pin, 3-lead, defibrillation-proof, AHA/IEC	Neonate, infant
EV6203	0010-30-42721	ECG cable, 12-lead, defibrillation-proof, AHA	Adult
EV6211	0010-30-42723	ECG cable, 12-pin, 3/5-lead, ESU-proof, AHA/IEC	Adult, pediatric
EV6212	0010-30-42724	ECG cable, 12-pin, 3-lead, ESU-proof, AHA/IEC	Neonate, infant
EV6206	009-005266-00	ECG cable, defibrillation-proof, 3.1 m, T/N series	Adult, pediatric
EV6207	009-005267-00	ECG cable, defibrillation-proof, 6.2 m, T/N series	Adult, pediatric
EV6216	009-005268-00	ECG cable, defibrillation-proof, 3.1 m, T/N series	Adult, pediatric
EV6217	009-005269-00	ECG cable, defibrillation-proof, 6.2 m, T/N series	Adult, pediatric
/	040-001416-00	ECG cable, 12-pin 3/5-lead defibrillation-proof	Adult, pediatric
/	009-003652-00	ECG cable, 12-pin 3/5-lead, ESU-proof	Adult, pediatric
EV6208	040-003528-00	12Pin 12-Lead Host Cable, AHA, Def-P(MW)	Adult, pediatric

ECG Leadwires

3-Electrode Leadwires			
Model	PN	Description	Applicable patient
EL6305A	0010-30-42896	ECG leadwires, 3-lead, AHA, pinch	Neonate, infant
EL6301A	0010-30-42726	ECG leadwires, 3-lead, AHA, pinch	Adult, pediatric
EL6303A	0010-30-42731	ECG leadwires, 3-lead, AHA, pinch, long	Adult, pediatric
EL6301B	0010-30-42734	ECG leadwires, 3-lead, AHA, snap	Adult, pediatric
EL6311B	040-000146-00	ECG leadwires, 3-lead, AHA, snap, single patient use	Neonate, infant
/	0012-00-1503-05	ECG Leadwires, 3-lead, Snap, 24" (61.0 cm), AAMI	Adult, pediatric
/	0012-00-1503-06	ECG Leadwires, 3-lead, Snap, 36" (101.6 cm), AAMI	Adult, pediatric
/	0012-00-1503-14	ECG Leadwires, 3-lead, Snap, 24" (61.0 cm), IEC	Adult, pediatric
/	0012-00-1503-15	ECG Leadwires, 3-lead, Snap, 36" (101.6 cm), IEC	Adult, pediatric
/	0012-00-1514-05	ECG Leadwires, 3-lead, Pinch, 24" (61.0 cm), AAMI	Adult, pediatric
/	0012-00-1514-06	ECG Leadwires, 3-lead, Pinch, 36" (101.6 cm), AAMI	Adult, pediatric
/	0012-00-1514-14	ECG Leadwires, 3-lead, Pinch, 24" (61.0 cm), IEC	Adult, pediatric
/	0012-00-1514-15	ECG Leadwires, 3-lead, Pinch, 36" (101.6 cm), IEC	Adult, pediatric
/	040-000748-01	Disp leadwires, 3-L snap, AAMI, 20 pk	Adult, pediatric
EY6316B	009-004765-00	3-lead, new telemetry, AHA, snap, 24"	Adult, pediatric
EY6305B	009-004766-00	3-lead, new telemetry, AHA, snap, 36"	Adult, pediatric
EY6316A	009-004771-00	3-lead, new telemetry, AHA, pinch, 24"	Adult, pediatric
EY6305A	009-004772-00	3-lead, new telemetry, AHA, pinch, 36"	Adult, pediatric
EY6310B	009-004777-00	3-lead, new telemetry, disposable, AHA, snap, 24"	Adult, pediatric

5-Electrode Leadwires			
Model	PN	Description	Applicable patient
EL6501A	0010-30-42727	ECG leadwires, 5-lead, AHA, pinch	Adult, pediatric
EL6503A	0010-30-42729	ECG leadwires, 5-lead, AHA, pinch, long	Adult, pediatric
EL6501B	0010-30-42735	ECG leadwires, 5-lead, AHA, snap	Adult, pediatric
/	0012-00-1503-02	ECG Leadwires, 5-lead, Snap, 24" (61.0 cm), AAMI	Adult, pediatric
/	0012-00-1503-03	ECG Leadwires, 5-lead, Snap, 36" (101.6 cm), AAMI	Adult, pediatric
/	0012-00-1503-11	ECG Leadwires, 5-lead, Snap, 24" (61.0 cm), IEC	Adult, pediatric
/	0012-00-1503-12	ECG Leadwires, 5-lead, Snap, 36" (101.6 cm), IEC	Adult, pediatric
/	0012-00-1514-02	ECG Leadwires, 5-lead, Pinch, 24" (61.0 cm), AAMI	Adult, pediatric
/	0012-00-1514-03	ECG Leadwires, 5-lead, Pinch, 36" (101.6 cm), AAMI	Adult, pediatric
/	0012-00-1514-11	ECG Leadwires, 5-lead, Pinch, 24" (61.0 cm), IEC	Adult, pediatric
/	0012-00-1514-12	ECG Leadwires, 5-lead, Pinch, 36" (101.6 cm), IEC	Adult, pediatric
/	040-000746-01	Disp leadwires, 5-L snap, AAMI, 20 pk	Adult, pediatric
EY6511B	009-004782-00	5-lead, new telemetry, AHA, snap, 24"	Adult, pediatric
EY6512B	009-004783-00	5-lead, new telemetry, AHA, snap, 36"	Adult, pediatric
EY6511A	009-004786-00	5-lead, new telemetry, AHA, pinch, 24"	Adult, pediatric
EY6512A	009-004787-00	5-lead, new telemetry, AHA, pinch, 36"	Adult, pediatric
EY6507B	009-004790-00	5-lead, new telemetry, disposable, AHA, snap, 24"	Adult, pediatric

12-Electrode Leadwires			
Model	PN	Description	Applicable patient
EL6801A	0010-30-42902	ECG leadwires, 12-lead, limb lead, AHA, pinch	Adult
EL6803A	0010-30-42904	ECG leadwires, 12-lead, chest lead, AHA, pinch	Adult
EL6801B	0010-30-42906	ECG leadwires, 12-lead, limb lead, AHA, snap	Adult
EL6803B	0010-30-42908	ECG leadwires, 12-lead, chest lead, AHA, snap	Adult

35.2 SpO₂ Accessories

Extension Cable

Model	Part No.	Description	Applicable patient
/	115-020768-00	8-pin, purple connector, 2.1 m, Masimo	All
572A	0010-20-42712	8-pin, 2.5 m, Nellcor	All
4080	040-003378-00	RD SET MD 14-05, PC 5 ft	All
4081	040-003379-00	RD SET MD 14-12, patient cable 12 ft	All
583A	040-003310-00	8pin Masimo cable (RD SET) for MAHWAH	All
4092	040-003426-00	LNCS to RD adapter	All
4089	040-003381-00	RD to LNC Adapter Cable	All
/	040-003310-00	8-pin Masimo Cable	All

SpO₂ Sensors

Masimo SpO ₂ Module				
Model	PN	Description	Applicable patient	Application site
LNCS DCI	0600-00-0126	Reusable SpO ₂ sensor	Adult	Finger
LNCS DCIP	0600-00-0127	Reusable SpO ₂ sensor	Pediatric	Finger
LNCS NeoPt	0600-00-0156	Disposable SpO ₂ sensor	Neonate	Foot
LNCS Neo	0600-00-0157	Disposable SpO ₂ sensor	Adult (> 40 kg) Neonate (< 3 kg)	Finger Foot
LNCS Inf	0600-00-0158	Disposable SpO ₂ sensor	Infant neonate (3 to 20 kg)	Toe Foot
LNCS Pdtx	0600-00-0122	Disposable SpO ₂ sensor	Pediatric	Finger
LNCS Adtx	0600-00-0121	Disposable SpO ₂ sensor	Adult	Finger
4050	040-003376-00	RD SET DCI, adult reusable sensor	Adult (> 30 kg)	Finger
4051	040-003377-00	RD SET DCI, pediatric reusable sensor	Pediatric (10 to 50 kg)	Finger
4053	040-003380-00	RD Set TC-I SpO ₂ reusable tip-clip ear sensor, 3ft	Adult (> 30 kg)	Ear
4000	040-003382-00	RD SET adhesive disposable sensor	Adult (> 30 kg)	Finger
4001	040-003383-00	RD SET PDT adhesive disposable senso	Pediatric (10 to 50 kg)	Finger
4002	040-003384-00	RD Set infant adhesive disposable sensor	Infant (3 to 20 kg)	Toe/Finger
4003	040-003385-00	RD Set neo adhesive disposable sensor	Adult (> 40 kg) Neonate (< 3 kg)	Foot/Finger
4004	040-003386-00	RD Set NeoPt adhesive disposable sensor	Neonate (< 1 kg)	Foot
4005	040-003387-00	RD Set NeoPt-500 nonadhesive disposable sensor	Neonate (< 1 kg)	Foot

Wavelength of Masimo SpO₂ sensors: red light: 660 nm; infrared light: 940 nm.

The maximum photic output consumption of the sensor is less than 18 mW.

The information about the wavelength range and maximum photic output consumption can be especially useful to clinicians (for example, when photodynamic therapy is performed).

35.3 NIBP Accessories

NIBP hoses

Model	Part No.	Description	Applicable patient
CM1901	6200-30-11560	Reusable NIBP hose	Neonate
CM1903	6200-30-09688	Reusable NIBP hose	Adult, pediatric, infant

Cuffs

Model	Part No.	Description	Applicable patient
CM1500A	001B-30-70692	NIBP cuff, single patient use, size 1, 3.1 to 5.7 cm arm circumference, 20 pcs/box	Neonate
CM1500B	001B-30-70693	NIBP cuff, single patient use, size 2, 4.3 to 8.0 cm arm circumference, 20 pcs/box	Neonate
CM1500C	001B-30-70694	NIBP cuff, single patient use, size 3, 5.8 to 10.9 cm arm circumference, 20 pcs/box	Neonate
CM1500D	001B-30-70695	NIBP cuff, single patient use, size 4, 7.1 to 13.1 cm arm circumference, 20 pcs/box	Neonate
/	115-027563-00	Disposable bladderless cuff, 10 - 19 cm, 10 pcs/box	Child
/	115-027564-00	Disposable bladderless cuff, 18 – 26 cm, 10 pcs/box	Small adult
/	115-027565-00	Disposable bladderless cuff, 24 – 35 cm, 10 pcs/box	Adult
/	115-027566-00	Disposable bladderless cuff, 33 – 47 cm, 10 pcs/box	Large adult
/	115-027567-00	Disposable bladderless cuff, 46 – 66 cm, thigh, 5 pcs/box	Adult
/	115-027568-00	Disposable bladderless long cuff, 24 – 35 cm, 10 pcs/box	Adult
/	115-027569-00	Disposable bladderless long cuff, 33 – 47 cm, 10 pcs/box	Large adult
/	115-027713-00	Reusable bladderless cuff, 10 - 19 cm	Child
/	115-027714-00	Reusable bladderless cuff, 18 – 26 cm	Small adult
/	115-027715-00	Reusable bladderless cuff, 24 – 35 cm	Adult
/	115-027716-00	Reusable bladderless cuff, 33 – 47 cm	Large adult
/	115-027717-00	Reusable bladderless cuff, 46 – 66 cm	Thigh
/	115-027718-00	Reusable bladderless long cuff, 24 – 35 cm	Adult
/	115-027719-00	Reusable bladderless long cuff, 33 – 47 cm	Large adult
/	115-031807-00	Starter kit, reusable bladderless cuff	/

35.4 Temp Accessories

Temp Cables

Model	Part No.	Description	Applicable patient
MR420B	0011-30-37391	2-pin, extension cable, applicable	All
MR421	0010-30-43056	Adapter cable	All
MR420B	040-001235-00	Temperature adapter cable (2-pin plug)	All

Temp Probes

Model	Part No.	Description	Applicable patient
MR411	0011-30-90446	Disposable temperature probe, esophageal	All
MR412	0011-30-90447	Disposable temperature probe, skin	All
MR401B	0011-30-37392	Reusable temperature probe, esophageal	Adult
MR402B	0011-30-37394	Reusable temperature probe, esophageal	Pediatric, neonate
MR403B	0011-30-37393	Reusable temperature probe, skin	Adult
MR404B	0011-30-37395	Reusable temperature probe, skin	Pediatric, neonate
/	0206-03-0112-02	PROBE,D TEMP,ES400-12 (box of 20)	Adult
/	0206-03-0118-02	PROBE,D TEMP,ES400-18 (box of 20)	Adult
/	0206-03-0209-02	PROBE,D TEMPER 400-9 (box of 20)	Adult
/	0206-03-0212-02	PROBE,D TEMPER400-12 (box of 20)	Adult
/	0206-03-0300-02	PROBE,D TEMP,STS-400 (box of 20)	Adult

35.5 IBP/ICP Accessories

IBP Accessories

Model	Part No.	Description	Applicable patient
IM2202	001C-30-70757	12-pin IBP cable, BD	All
IM2201	001C-30-70759	12-pin IBP cable, Abbott	All
/	0010-20-42795	IBP cable adapter (12 pin to 6 pin)	/
/	0010-21-12179	12 Pin IBP Cable for Edwards	/
/	0010-21-43082	12 Pin IBP Cable for Memscap (SP844 82031 transducer)	/

ICP Accessories

Model	Part No.	Description	Applicable patient
/	0010-30-42742	12-pin ICP cable, Gaeltec	All
ICT/B	0010-10-12151	Disposable ICP transducer, Gaeltec	All

35.6 C.O. Accessories

Model	Part No.	Description
CO7702	0010-30-42743	12-pin C.O. cable.
SP4042	6000-10-02079	TI sensor
SP5045	6000-10-02080	TI sensor housing
MX387	6000-10-02081	12 cc control syringe W/1CC stop W/rotator
/	0012-00-1519	Cable, C.O. Edwards Lifesciences bath probe adapter
/	6800-30-50617	Becton Dickinson C.O. accessory kit (includes 12 pin cable, BD accessories)
93522	0012-00-1520	In-line inject temperature Probe

35.7 CO₂ Accessories

Sidestream CO₂ module

Model	Part No.	Description	Applicable patient	Applicable for
4000	M02A-10-25937	Nasal CO ₂ sample cannula	Adult	Two-slot CO ₂ module and one-slot CO ₂ module
4100	M02A-10-25938	Nasal CO ₂ sample cannula	Pediatric	
4200	M02B-10-64509	Nasal CO ₂ sample cannula	Neonate	
60-15200-00	9200-10-10533	Sampling line, 2.5m, disposable	Adult, pediatric	
60-15300-00	9200-10-10555	Sampling line, 2.5m, disposable	Neonate	
60-14100-00	9000-10-07486	Airway adapter, disposable, straight	Adult, pediatric	
040-001187-00	040-001187-00	Airway adapter, disposable, elbow	Neonate	
60-13100-00	125-000005-00	Watertrap, 10pcs/box	Adult, pediatric	Two-slot CO ₂ module
60-13200-00	125-000006-00	Watertrap, 10pcs/box	Neonate	One-slot CO ₂ module
100-000080-00	115-058733-00	DRYLINE II Watertrap, 10pcs/box	Adult, pediatric	
100-000081-00	115-058734-00	DRYLINE II Watertrap, 10pcs/box	Neonate	

35.8 AG Accessories

Model	Part No.	Description	Applicable patient	Applicable for
60-13100-00	125-000005-00	Watertrap, 10pcs/box	Adult, pediatric	Three-slot AG module
60-13200-00	125-000006-00	Watertrap, 10pcs/box	Neonate	
60-14100-00	9000-10-07486	Airway adapter, disposable, straight	/	Three-slot AG module and two-slot AG module
040-001187-00	040-001187-00	Airway adapter, disposable, elbow	Neonate	
60-15200-00	9200-10-10533	Sampling line, 2.5m, disposable	Adult, pediatric	
60-15300-00	9200-10-10555	Sampling line, 2.5m, disposable	Neonate	
/	115-052162-00	AG exhasust gas outlet assembly	Adult, pediatric	
100-000080-00	115-058733-00	DRYLINE II Watertrap, 10pcs/box	Adult, pediatric	Two-slot AG module
100-000081-00	115-058734-00	DRYLINE II Watertrap, 10pcs/box	Neonate	
60-14200-00	9000-10-07487	Airway adapter, disposable,elbow	Adult, pediatric	

35.9 BIS Accessories

Model	Part No.	Description	Applicable patient
186-0195-MR	6800-30-50761	BIS module and cable	/
186-0224-MR	115-005707-00	BISx4 module and cable	/

35.10 NMT Accessories (for Mindray NMT module)

Model	Part No.	Description	Applicable patient
NM13101	040-001462-00	NMT cable	Adult, pediatric
NM13401	040-001463-00	NMT sensor cable	Adult, pediatric
NM13701	040-001464-00	NMT stimulation cable	Adult, pediatric
/	040-002258-00	NMT sensor securing strap,20 pcs/box	Adult, pediatric

35.11 RM Accessories

Model	Part No.	Description	Applicable patient
CP12901	6800-20-50328	RM connector	/
PN155362	0010-30-42678	Flow sensor, Hamilton, reusable	Adult, pediatric
PN155500	0010-30-42680	Flow sensor, Hamilton, disposable	Infant

35.12 CCO/SvO₂ Accessories

Model	Part No.	Description	Applicable patient
/	009-000259-00	CCO/SvO ₂ Cable	/

35.13 ScvO₂ Accessories

Model	Part No.	Description	Applicable patient
PC3030	115-008191-00	8Pin ScvO ₂ Module and Cable	/
PV2022-37	040-000919-00	CeVOX Probe (37cm)	/
PV2022-35	040-000920-00	CeVOX Probe (35cm)	/

35.14 Installation Accessories

Passport 17m

Part No.	Material
045-003426-00	Main unit wall mount bracket
045-000933-00	Satellite module rack wall mount bracket
045-000934-00	Keyboard wall mount bracket
045-000936-00	Display wall mount bracket
045-001302-00	Passport 17m wall mount bracket (VHM)

Passport 12m

Part No.	Material
045-000915-00	Roll stand
045-003426-00	Main unit wall mount bracket
045-000933-00	Satellite module rack wall mount bracket
045-000934-00	Keyboard wall mount bracket
045-000936-00	Display wall mount bracket
045-001275-00	Passport 12m quick release
045-001300-00	Passport 12m wall mount bracket
045-001301-00	Passport 12m wall mount bracket (VHM)

35.15 Miscellaneous Accessories

Part No.	Material
022-000008-00	Lithium battery, LI23S002A
DA8K-10-14452	Power cord (America)
1000-21-00122	Grounding cable
009-000027-00	Defibrillator synchronization cable
8000-21-10361	Nurse call cable ($\leq 60W$, $\leq 2A$, $\leq 36VDC$, $\leq 25VAC$)
115-004861-00	DVI-VGA adapter box
009-003648-00	Cable protecting tube
009-003903-00	Accessories management tape
115-011465-00	BeneLikn ID adapter
023-000524-00	Wireless mouse and keyboard kit
023-000525-00	Wired mouse and keyboard kit
023-000217-00	USB drive, 4GB, USB 2.0 (TRANSCEND)
023-001673-00	USB drive, 8GB, USB 3.0 (APACER)
023-000846-00	CF card
023-001566-00	HP LaserJet Enterprise M608n
023-001128-00	Elo ET1929LM, 19-inch black LCD
A30-000001---	Recording paper, 50 mm*20 m
115-046944-00	SMR material package(2M/handle/hook)
115-046949-00	SMR material package(2M/no handle)
115-033914-00	SMR NIBP bracket installation kit
115-033911-00	SMR cable management hook installation kit

36 Part Numbers for Canadian Use

All the part numbers listed in the table below are modules that are compatible with the Passport 12m and Passport 17m patient monitors. Our Passport 12m and Passport 17m patient monitors offer various optional modules to accommodate the customer's different needs.

Part No.	Description	Contents
M51AF-PA00046	Masimo SpO ₂ , 3/5-lead ECG, IBP	Module Part Number: 115-022715-00 Accessories kit (PN 115-023313-00) which contains: 040-001235-00 - Temperature Cable 040-001416-00 - ECG cable 0012-00-1503-02 - ECG Leadwire 115-020768-00 - Masimo SpO ₂ cable 100-000078-00 - Reusable Adult Masimo SpO ₂ sensor 115-027715-00 - Reusable Adult NIBP Cuff 6200-30-09688 - NIBP Hose
115-023313-00	MPM Accessory kit - Masimo SpO ₂	040-001235-00 - Temperature Cable 040-001416-00 - ECG cable 0012-00-1503-02 - ECG Leadwire 115-020768-00 - Masimo SpO ₂ cable 100-000078-00 - Reusable Adult Masimo SpO ₂ sensor 115-027715-00 - Reusable Adult NIBP Cuff 6200-30-09688 - NIBP Hose
M51AF-PA00050	Masimo SpO ₂ , 3/5-lead ECG, IBP, Advanced Arrhythmia and ST analysis	This kit has the same contents as M51AF-PA00046 with the difference between them being that this configuration contains the Advanced ST/ARR Software
M51AF-PA00049	Masimo SpO ₂ , 3/5/12-lead ECG, IBP, Advanced Arrhythmia and ST analysis	Module Part Number:115-022718-00 Accessories kit (PN 115-023313-00) which contains: 040-001235-00 - Temperature Cable 040-001416-00 - ECG cable 0012-00-1503-02 - ECG Leadwire 115-020768-00 - Masimo SpO ₂ cable 100-000078-00 - Reusable Adult Masimo SpO ₂ sensor 115-027715-00 - Reusable Adult NIBP Cuff 6200-30-09688 - NIBP Hose

Part No.	Description	Contents
M51AF-PA00042	Nellcor SpO ₂ , 3/5-lead ECG, IBP	Module Part Number 115-022716-00 Accessories kit (PN 115-023314-00) which contains: 040-001235-00 - Temperature Cable 040-001416-00 - ECG cable 0012-00-1503-02 - ECG Leadwire 0010-20-42712 - Nellcor SpO ₂ cable License 9000-10-05161 - Reusable Adult Nellcor SpO ₂ sensor 115-027715-00 - Reusable Adult NIBP Cuff 6200-30-09688 - NIBP Hose
115-023314-00	MPM Accessory kit - Nellcor SpO ₂	040-001235-00 - Temperature Cable 040-001416-00 - ECG cable 0012-00-1503-02 - ECG Leadwire 0010-20-42712 - Nellcor SpO ₂ cable License 9000-10-05161 - Reusable Adult Nellcor SpO ₂ sensor 115-027715-00 - Reusable Adult NIBP Cuff 6200-30-09688 - NIBP Hose
M51AF-PA00044	Nellcor SpO ₂ , 3/5-lead ECG, IBP, Advanced Arrhythmia and ST analysis	This kit has the same contents as M51AF-PA00042 with the difference between them being that this configuration contains the Advanced ST/ARR Software
M51AF-PA00045	Nellcor SpO ₂ , 3/5/12-lead ECG, IBP, Advanced Arrhythmia and ST analysis	Module Part Number 115-022719-00 Accessories kit (PN 115-023314-00) which contains: 040-001235-00 - Temperature Cable 040-001416-00 - ECG cable 0012-00-1503-02 - ECG Leadwire 0010-20-42712 - Nellcor SpO ₂ cable License 9000-10-05161 - Reusable Adult Nellcor SpO ₂ sensor 115-027715-00 - Reusable Adult NIBP Cuff 6200-30-09688 - NIBP Hose
115-030472-00	Benelink module	Module Part Number: 115-030471-00
6800-30-50878	Adult BIS 2X accessory kit	Module Part Number: 6800-30-50761 0010-10-42672 - 5 BIS Sensors (Quatro)
6800-30-50144	Pediatric BIS 2X accessory kit	Module Part Number: 6800-30-50761 0010-10-42673 - 5 BIS pediatric Sensors (Quatro)
115-013249-00	CCO/SvO ₂ Module with interface cable	Module Part Number: 115-003480-00 009-000259-00 - CCO/SVO ₂ Cable
115-030585-00	2-ch IBP module	Module Part Number: 115-029851-00
6800-30-50820	Microstream CO ₂ module with accessory kit	Module Part Number: 6800-30-50558 Accessories kit: 6800-30-50619 which contains 0010-10-42560 - XS-04620 Oridion Filter Line set 0010-10-42577 - 8174 Oridion NIV-Line

Part No.	Description	Contents
6800-30-50619	Microstream CO ₂ Accessory Kit	0010-10-42560 - XS-04620 Oridion Filter Line set 0010-10-42577 - 8174 Oridion NIV-Line
6800-30-50842	Multi-Gas Module with auto ID, O ₂ and Multi-Gas accessory kit	Module Part Number: 6800-30-50585 Accessories kit 6800-30-50621 which contains: 9200-10-10530 - Dryline water trap, Adult/Pediatric, box of 10 9200-10-10574 - Dryline water trap, Neonatal, box of 10 9200-10-10533 - Sampling line, Adult, 2.5 m, box of 25 9200-10-10555 - Sampling line, Neonatal, 2.5 m, box of 25 9000-10-07486 - Dryline airway adapter, straight, box of 10 9000-10-07487- Dryline airway adapter, elbow, box of 10
6800-30-50621	Multi-Gas Accessory Kit	9200-10-10530 - Dryline water trap, Adult/Pediatric, box of 10 9200-10-10574 - Dryline water trap, Neonatal, box of 10 9200-10-10533 - Sampling line, Adult, 2.5 m, box of 25 9200-10-10555 - Sampling line, Neonatal, 2.5 m, box of 25 9000-10-07486 - Dryline airway adapter, straight, box of 10 9000-10-07487- Dryline airway adapter, elbow, box of 10
6800-30-50853	Respiratory Mechanics Module with accessory kit	Module Part Number: PN 6800-30-50488 Accessory kit (Part Number 6800-30-50612) which contains: 0010-30-42678 - Adult/Pediatric reusable flow sensor 6800-20-50328 - RM Connecting Plug
6800-30-50612	Respiratory Mechanics Accessory Kit	0010-30-42678 - Adult/Pediatric reusable flow sensor 6800-20-50328 - RM Connecting Plug
6800-30-50139	Sidestream CO ₂ module with adult/pediatric	Module Part Number: 6800-30-50137

Part No.	Description	Contents
	CO ₂ accessory kit	Accessory Kit (Part Number 6800-30-50618) which contains: 9200-10-10530 - Dryline water trap, Adult/Pediatric, box of 10 9200-10-10533 Adult Sampling Line 9000-10-07486 - Airway Adapter M02A-10-25937 - Adult Nasal Cannula M02A-10-25938 - Pediatric Nasal Cannula
6800-30-50618	Adult/pediatric CO ₂ accessory kit	9200-10-10530 - Dryline water trap, Adult/Pediatric, box of 10 9200-10-10533 Adult Sampling Line 9000-10-07486 - Airway Adapter M02A-10-25937 - Adult Nasal Cannula M02A-10-25938 - Pediatric Nasal Cannula
6800-30-50467	Sidestream CO ₂ kit, Neonatal	9200-10-10574 - Dryline water trap, Neonatal, box of 10 9200-10-10555 - Sampling line, Neonatal, 2.5 m, box of 25 M02B-10-64509 same as License 6892 (Salter Labs) / 4200 9000-10-07486 - Airway Adapter
115-023310-00	Masimo module (additional-including cable and adult reusable sensor)	Module Part Number: 115-020921-00 Accessories kit (115-020769-00) which contains: 115-020768-00 - Masimo SpO ₂ cable 100-000078-00 - Reusable Adult Masimo SpO ₂ sensor
115-020769-00	Masimo Accessory Kit	115-020768-00 - Masimo SpO ₂ cable 100-000078-00 - Reusable Adult Masimo SpO ₂ sensor
115-021056-00	Sidestream CO ₂ module (1X) with neonatal accessory kit	Module Part Number 115-020189-00 Accessory Kit: 115-021055-00 which contains: 9200-10-10555 - Neonate Sampling Line 100-000081-00 - Dryline II water trap M02B-10-64509 - Neonate Nasal Cannula 040-001187-00 - Airway Adapter
115-021055-00	Sidestream CO ₂ module (1X) neonatal accessory kit	9200-10-10555 - Neonate Sampling Line 100-000081-00 - Dryline II water trap, neonate M02B-10-64509 - Neonate Nasal Cannula 040-001187-00 - Airway Adapter

Part No.	Description	Contents
115-020919-00	Sidestream CO ₂ module with adult/pediatric accessory kit	Module Part Number 115-020189-00 Accessory Kit: 115-021054-00 which contains: 9200-10-10533 Adult Sampling Line 100-000080-00 - Dryline II water trap, adult M02A-10-25937 - Adult Nasal Cannula M02A-10-25938 - Pediatric Nasal Cannula 9000-10-07486 - Airway Adapter
115-021054-00	Sidestream CO ₂ module (1X) adult/pediatric accessory kit	9200-10-10533 Adult Sampling Line 100-000080-00 - Dryline II water trap, adult M02A-10-25937 - Adult Nasal Cannula M02A-10-25938 - Pediatric Nasal Cannula 9000-10-07486 - Airway Adapter

FOR YOUR NOTES

A Product Specifications

NOTE

- For the specifications of T1 and N1, refer to their operating manuals.

A.1 Monitor Safety Specifications

A.1.1 Classifications

The monitor is classified, according to IEC60601-1:

Components	Type of protection against electrical shock	Degree of protection against electrical shock	Degree of protection against harmful ingress of water	Degree of protection against hazards of explosion	Mode of operation
Main unit	I	Not marked	IPX 1	Not suitable	Continuous
MPM	NA	CF(*)			
IBP module					
SpO ₂ module					
NMT module					
C.O. module					
BIS module		BF(*)			
AG module					
CO ₂ module					
RM module					
ScvO ₂ module					
BeneLink module		Not marked			
SMR		Not marked			
CCO/SvO ₂ module		Not marked			

- I: Class I equipment
- BF: Type BF applied part. (*Defibrillator-proof protection against electric shock.)
- CF: Type CF applied part. (*Defibrillator-proof protection against electric shock.)
- NA: Not applicable
- IPX1: Protection against vertically falling water drops.
- Not suitable: Equipment not suitable for use in the presence of a flammable anesthetic gas mixture.

A.1.2 Environmental Specifications

CAUTION

- The equipment may not meet the performance specifications if stored or used outside the specified temperature and humidity ranges.

Main unit, MPM, SpO₂ module, IBP module, C.O. module, Recorder, CCO/SvO₂ module, BIS module, BeneLink module, NMT module		
Item	Operating conditions	Storage conditions
Temperature (°C)	0 to 40	-20 to 60
Relative humidity (noncondensing)	15% to 95%	10% to 95%
Barometric (mmHg)	427.5 to 805.5	120 to 805.5

Microstream CO₂ module		
Item	Operating conditions	Storage conditions
Temperature (°C)	0 to 40	-20 to 60
Relative humidity (noncondensing)	15% to 95%	10% to 95%
Barometric (mmHg)	430 to 790	430 to 790

Sidestream CO₂ module		
Item	Operating conditions	Storage conditions
Temperature (°C)	5 to 40	-20 to 60
Relative humidity (noncondensing)	15% to 95%	10% to 95%
Barometric (mmHg)	430 to 790	430 to 790

AG module		
Item	Operating conditions	Storage conditions
Temperature (°C)	10 to 40	-20 to 60
Relative humidity (noncondensing)	15% to 95%	10% to 95%
Barometric (mmHg)	525 to 805.5	525 to 805.5

RM module		
Item	Operating conditions	Storage conditions
Temperature (°C)	5 to 40	-20 to 60
Relative humidity (noncondensing)	15% to 95%	10% to 95%
Barometric (mmHg)	427.5 to 805.5	120 to 805.5

ScvO₂ module		
Item	Operating conditions	Storage conditions
Temperature (°C)	10 to 40	-20 to 60
Relative humidity (noncondensing)	15% to 75%	10% to 90%
Barometric (mmHg)	427.5 to 805.5	120 to 805.5

Note

- The environmental specifications of unspecified parameters are the same as those of the main unit.

A.1.3 Power Supply Specifications

Line voltage	100 to 240 VAC ($\pm 10\%$)
Current	Passport 12m: 2.5 to 1.4 A Passport 17m: 2.8 to 1.6 A
Frequency	50 Hz /60 Hz (± 3 Hz)
Fuse	Passport 12m: Time-lag 250V T3.15A Passport 17m: Time-lag 250V T4A

A.2 Physical Specifications

Components	Weight	Size	Equipment type
Main unit (Passport 12m)	<7.5 kg (16.5 pound)	297×336×187 mm (11.7×13.2×7.4 inch)	Without modules, batteries, accessories, and recorder
Main unit (Passport 17m)	<12.0 kg (26.5 pound)	400×370×193 mm (15.7×14.5×7.6 inch)	
SMR (OEM)	<1.8 kg (4.0 pound)	142×402×151 mm (5.6×15.8×5.9 inch)	With no module inserted
SMR (Mindray)	<2.30 kg (5.1 pound)	403× 221× 145 mm (15.9×8.7×5.7inch)	With a handle and cable hooks
MPM	<0.63 kg (1.4 pound)	136.5×80.5×102 mm (5.4×3.2×4.0 inch)	
SpO ₂ module	<0.26 kg (0.57 pound)	136.5×40×102 mm (5.4×1.6×4.0 inch)	
IBP module	<0.25 kg (0.55 pound)	136.5×40×102 mm (5.4×1.6×4.0 inch)	
C.O. module	<0.25 kg (0.55 pound)	136.5×40×102 mm (5.4×1.6×4.0 inch)	
Sidestream CO ₂ module (2 slots)	<0.48 kg (1.1 pound)	136.5×80.5×102 mm (5.4×3.2×4.0 inch)	
Sidestream CO ₂ module (1 slot)	<0.60 kg (1.3 pound)	136.5×40×102 mm (5.4×1.6×4.0 inch)	
Microstream CO ₂ module	<0.37 kg (0.8 pound)	136.5×40×102 mm (5.4×1.6×4.0 inch)	
AG module (3 slots)	<1.75 kg (3.8 pound)	136.5×121×102 mm (5.4×4.8×4.0 inch)	With O ₂ and BIS modules
AG module (2 slots)	<1.03 kg (2.27 pound)	136.5 × 80.5 × 102 (5.4×3.2×4.0 inch)	With O ₂ module
AG module (2 slots)	<1.15 kg (2.53 pound)	136.5 × 80.5 × 102 (5.4×3.2×4.0 inch)	With O ₂ and BIS modules
BIS module	<0.25 kg (0.55 pound)	136.5×40×102 mm (5.4×1.6×4.0 inch)	
RM module	<0.27 kg (0.59 pound)	136.5×40×102 mm (5.4×1.6×4.0 inch)	
CCO/SvO ₂ module	<0.25 kg (0.55 pound)	136.5×40×102 mm (5.4×1.6×4.0 inch)	
ScvO ₂ module	<0.26 kg (0.57 pound)	136.5×40×102 mm (5.4×1.6×4.0 inch)	
BeneLink module	<0.35kg (0.8 pound)	136.5×40×102 mm (5.4×1.6×4.0 inch)	
NMT module	<0.30 kg (0.66 pound)	136.5×40×102 mm (5.4×1.6×4.0 inch)	

A.3 Hardware Specifications

A.3.1 Display

Host display	
Screen type	Color TFT LCD
Screen Size (diagonal)	12"(Passport 12m); 17"(Passport 17m)
Resolution	800×600 pixels(Passport 12m); 1280×1024 pixels(Passport 17m)
Secondary display	
Screen type	Medical-grade TFT LCD
Screen Size	Passport 12m: 15", 17",19" Passport 17m: 17", 19"

A.3.2 Recorder

Method	Thermal dot array
Horizontal resolution	16 dots/mm (25 mm/s paper speed)
Vertical resolution	8 dots/mm
Paper width	50 mm
Paper length	20 m
Paper speed	25 mm/s, 50 mm/s
Number of waveform channels	Maximum 3

A.3.3 Battery

Size	147.5×60.4×23.8 mm (5.8×2.4×0.9 inch)
Weight	350 g
Number of batteries	1 or 2 (Passport 12m); 2 (Passport 17m)
Battery Type	Chargeable Lithium-Ion
Voltage	11.1 VDC
Capacity	4500 mAh
Run time	Passport 12m: 330 minutes when powered by two new fully-charged batteries (25°C, SpO ₂ sensor connected, ECG and Temp cables disconnected, Auto NIBP measurements at an intervals of 15 minutes) Passport 17m: 120 minutes when powered by two new fully-charged batteries (25°C, SpO ₂ sensor connected, ECG and Temp cables disconnected, Auto NIBP measurements at an intervals of 15 minutes)
Charge time	less than 5.5 h to 90% less than 6 h to 100%
Shutdown delay	at least 5 min (after a low battery alarm first occurs)

A.3.4 LEDs

Alarm lamp	1 (two color coded: yellow and red)
Power on LED	1 (green)
AC power LED	1 (green)
Battery LED	1 (green)

A.3.5 Audio Indicator

Speaker	Give alarm tones (45 to 85 dB), key tones, QRS tones; support PITCH TONE and multi-level tone modulation; alarm tones comply with IEC60601-1-8.
---------	-------------------------------------------------------------------------------------------------------------------------------------------------

A.3.6 Monitor Interface Specifications

Power	1 AC power input connector
Wired network	Passport 12m: 1 RJ45 connector, 100 Base-TX, IEEE 802.3 Passport 17m: 2 RJ45 connector, 100 Base-TX, IEEE 802.3
USB	Passport 12m: 4 connectors, USB 1.1; Passport 17m: up to 10 connectors, USB 1.1
SMR connector	1 connector, not standard USB
CF	50-pin CF revision 2.0 connector
Video interface	1 connector, standard DVI-D
Nurse call	1 connector, standard BNC
Equipotential Grounding Terminal	1 terminal
Micro-D connector	1 connector, standard Micro-D

A.3.7 Outputs

Auxiliary Output	
Standard	Meets the requirements of IEC60601-1 for short-circuit protection and leakage current
ECG Analog Output	
Bandwidth (-3dB; reference frequency: 10Hz)	Diagnostic mode: 0.05 to 150 Hz Monitor mode: 0.5 to 40 Hz Surgical mode: 1 to 20 Hz ST mode: 0.05 to 40 Hz
QRS delay	≤25 ms (in diagnostic mode, and non-paced)
Sensitivity	1V/mV ±5%
PACE rejection/enhancement	Pace enhancement Signal amplitude: $V_{oh} \geq 2.5V$ Pulse width: 10ms±5% Signal rising and falling time: ≤100μs
IBP Analog Output	
Bandwidth (-3dB; reference frequency: 1 Hz)	DC to 40 Hz

Max transmission delay	≤30 ms
Sensitivity	1 V/100 mmHg ±5%
Nurse Call Signal	
Amplitude	High level: 3.5 to 5 V, providing a maximum of 10 mA output current; Low level: < 0.5 V, receiving a maximum of 5 mA input current.
Rising and falling time	≤1 ms
Defib Sync Pulse	
Output impedance	≤100Ω
Max time delay	35 ms (R-wave peak to leading edge of pulse)
Amplitude	High level: 3.5 to 5 V, providing a maximum of 10 mA output current; Low level: < 0.5 V, receiving a maximum of 5 mA input current.
Pulse width	100 ms ±10%
Rising and falling time	≤1 ms
Digital video output (DVI-D connector)	
Video signals	Single Link TMDS
DDC signals	Signals 12C compliant
Alarm output (Network connector)	
Alarm delay time from the monitor to remote equipment	The alarm delay time is equal to or smaller than 2 s, measured from the time of the monitor alarm signal generation to the time of the remote equipment alarm signal generation.

A.4 Data Storage

Trends	Trends: 120 hours, at 1 min resolution Mid-length trends: 4 hours, at 5 s resolution Minitrends: 1 hour, at 1 s resolution
Parameter alarms	100 physiological alarms and manual events and related parameter waveforms.
OxyCRG events	100 OxyCRG events
Arrh. events	100 arrhythmia events and relate waveforms and parameters.
NIBP measurements	1000 sets
Full-disclosure waveforms	48 hours at maximum. The specific storage time depends on the waveforms stored and the number of stored waveforms.

A.5 Wireless Network (For Passport 12m Only)

Protocol	IEEE 802.11a/b/g/n
Modulation mode	DSSS and OFDM
Operating frequency	2.4G Frequency Bands(FCC):2.4 GHz to 2.483GHz (only use channel 1 to channel 11) 5G Frequency Bands(FCC): 5.15 GHz to 5.35GHz, 5.47GHz to 5.725GHz, 5.725GHz to 5.85GHz
Channel spacing	IEEE 802.11a: 20MHz IEEE 802.11b/g: 5MHz IEEE 802.11n at 2.4 GHz: 5MHz IEEE 802.11n at 5 GHz: 20MHz
Wireless baud rate (data rate)	IEEE 802.11a: 6 to 54 Mbps IEEE 802.11b: 1 to 11 Mbps IEEE 802.11g: 6 to 54 Mbps IEEE 802.11n (at both 2.4GHz and 5GHz): 6.5 to 72.2 Mbps
Output power (transfer power)	< 20 dBm (CE requirement: detection mode – RMS); < 30 dBm (FCC requirement: detection mode – peak power).
Operating mode	Infrastructure
Data security	Standards: WPA/WPA2-PSK, WPA/WPA2-Enterprise EAP methods: PEAP-MsCHAPv2, EAP-FAST, EAP-TLS, EAP-TTLS, PEAP-GTC, PEAP-TLS, EAP-LEAP Encryptions: TKIP,AES
Communication with the central station	<ol style="list-style-type: none"> 1. The Passport 12m transmits waveforms and numerics of parameters (e.g. ECG, Resp, Temp, SpO₂, CO₂, NIBP), related alarms and alarm settings, patients' information, operating mode, and and historical data, including trends and events, to the central station. The waveforms, numerics, alarms, alarm settings, patients' information, operating mode, and historical data displayed on the central station are consistent with the Passport 12m. 2. When so configured, the central station transmits alarm settings, patients' information, and operating mode settings to the Passport 12m. The alarm settings, patients' information, and operating mode settings of the Passport 12m are consistent with the central station.
Communication with other monitors	The Passport 12m transmits waveforms, numerics of parameters (e.g. ECG, Resp, Temp, SpO ₂ , CO ₂ , NIBP), and related alarms to other monitors. The waveforms, numerics, and alarms displayed on other monitors are consistent with the Passport 12m.
Data integrity	The probability for loss of application data within wireless network shall be less than 1000ppm (0.1%).
Data latency	Total delay of data transmission from the Passport 12m to the central station: ≤ 2s Delay of the central station to configure related settings of the Passport 12m: ≤ 2s Total delay of data transmission from Passport 12m to other patient monitors: ≤ 2s Delay of other patient monitors to reset the alarms of the Passport 12m: ≤ 2s
Priority	QoS setting is supported. All communication data types have the same priority at default, but real time monitoring data transmission priority can be configured with a

	higher priority than other data transmission.
Transmission distance	With line of sight from the Passport 12m to the AP, the transmission distance shall be no less than 50 m.
Roaming	Network switchover is automatically implemented when the Passport 12m moves from the coverage area of AP1 to that of AP2.
System capacity	Number of Passport 12m monitors supported by a single AP: ≤ 16 . Each Passport 12m can communicate with the central station and connect to two other monitors at the same time, and among them, at most two Passport 12m can transmit historical data when reconnected at the same time. The wireless functions of all Passport 12m monitors are normal at the same time.
Resistance to wireless interference	The wireless functions of the Passport 12m are normal when the following conditions exist simultaneously: <ol style="list-style-type: none"> 1. The distance between interfering devices (including wireless devices at the frequency of 2.4GHz, cellular communication devices, microwave ovens, intercoms, cordless phones and electro-surgical units, exclude Wi-Fi) and the monitor is greater than 20 cm. 2. Co-channel interference (CCI) on the Wi-Fi network should be no greater than -85dBm. 3. Adjacent-channel interference (ACI) on the Wi-Fi network should be no greater than -50dBm.
Dynamic networking stability	The wireless functions of the test monitor are normal when the Passport 12m is moving at the rate of no more than 3.75 m/s within a 15m non-blocking linear distance.
Network interruption alarm	<ol style="list-style-type: none"> 1. When network interruption occurs, the Passport 12m screen shows a disconnection icon, and the system initiates the related alarms. 2. When the network is reconnected, wireless connection recovers automatically.
Loss of data	When 16 Passport 12m monitors are connected to one AP, the probability for loss of data between the subject Passport 12m monitor and the BeneVision central station is less than 0.1% in a 24 hour period, with any 12 of the 16 Passport 12m monitors roaming 30 times.
FCC approval	SQG-WB45NBT

A.6 Measurement Specifications

The adjustable range for alarm limits is the same as the measurement range for the parameter unless otherwise specified.

A.6.1 ECG

ECG	
Standards	Meet standards of EC11, EC13, EN60601-2-27/IEC60601-2-27 and IEC60601-2-25
Lead set	3-lead: I, II, III 5-lead: I, II, III, aVR, aVL, aVF, V 12-lead: I, II, III, aVR, aVL, aVF, V1 to V6
ECG standard	AHA, IEC
Display sensitivity	1.25 mm/mV (X0.125), 2.5 mm/mV (X0.25), 5 mm/mV (X0.5), 10 mm/mV (X1), 20 mm/mV (X2), 40 mm/mV (X4), Auto
Sweep speed	6.25 mm/s, 12.5 mm/s, 25 mm/s, 50 mm/s
Bandwidth (-3dB)	Diagnostic mode: 0.05 to 150 Hz Monitor mode: 0.5 to 40 Hz Surgical mode: 1 to 20 Hz ST mode: 0.05 to 40 Hz
Common mode rejection ratio (with Notch off)	Diagnostic mode: >90 dB Monitor mode: >105 dB Surgical mode: >105 dB ST mode: >105 dB
Notch filter	50/60 Hz Monitor, ST and surgical mode: Notch turns on automatically. Diagnostic mode: Notch is turned on/off manually
Differential input impedance	≥5 MΩ
Input signal range	±8 mV (peak-to-peak value)
Accuracy of signal reproduction	Use A and E methods based on IEC 60601-2-25 to determine frequency response.
Electrode offset potential tolerance	±500 mV
Lead-off detection current	Measuring electrode: <0.1 μA Drive electrode: <1 μA
Input offset current	Measuring electrode: ≤0.1 μA Drive electrode: ≤1 μA
Baseline recovery time	<5 s (after defibrillation)
Patient leakage current	<10 μA
Calibration signal	1mV (peak-to-peak value)
ESU protection	Cut mode: 300 W Coagulate mode: 100 W Recovery time: ≤10 s In compliance with the requirements in IEC 60601-2-27: Clause 202.6.2.101
Sampling rate	500 samples/s (A/D) 500 samples/s (ECG algorithm)
Accuracy	2.44μV/LSB

Pace Pulse	
Pace pulse markers	<p>Pace pulses meeting the following conditions are labeled with a PACE marker:</p> <p>Amplitude: ± 2 to ± 700 mV</p> <p>Width: 0.1 to 2 ms</p> <p>Rise time: 10 to 100 μs</p>
Pace pulse rejection	<p>When tested in accordance with the IEC60601-2-27: 201.12.1.101.13, the heart rate meter rejects all pulses meeting the following conditions.</p> <p>Amplitude: ± 2 to ± 700 mV</p> <p>Width: 0.1 to 2 ms</p> <p>Rise time: 10 to 100 μs</p>
Pacer pulse detector rejection of fast ECG signals	2.9 V/s RTI when measured in accordance with IEC60601-2-27 Section 4.1.4.3.

Advanced ECG algorithm

HR			
Measurement range	<table border="1"> <tr> <td>3-, 5-, and 12-lead ECG</td> <td> <p>Neonate: 15 to 350 bpm</p> <p>Pediatric: 15 to 350 bpm</p> <p>Adult: 15 to 300 bpm</p> </td> </tr> </table>	3-, 5-, and 12-lead ECG	<p>Neonate: 15 to 350 bpm</p> <p>Pediatric: 15 to 350 bpm</p> <p>Adult: 15 to 300 bpm</p>
3-, 5-, and 12-lead ECG	<p>Neonate: 15 to 350 bpm</p> <p>Pediatric: 15 to 350 bpm</p> <p>Adult: 15 to 300 bpm</p>		
Resolution	1 bpm		
Accuracy	± 1 bpm or $\pm 1\%$, whichever is greater.		
Sensitivity	200 μ V (lead II)		
Minimum QRS detection threshold (for Advanced ECG algorithm only)	<p>Adult and pediatric: 0.16 – 0.48 mV</p> <p>Neonate: 0.12 – 0.40 mV</p>		
HR averaging method	<p>In compliance with the requirements in IEC60601-2-27: Clause 201.7.9.2.9.101 b) 3) , the following method is used:</p> <p>If the last 3 consecutive RR intervals are greater than 1200 ms, the 4 most recent RR intervals are averaged to compute the HR. Otherwise, heart rate is computed by subtracting the maximum and minimum ones from the most recent 12 RR intervals and then averaging them.</p> <p>The HR value displayed on the monitor screen is updated every second.</p>		
Response to irregular rhythm	<p>In compliance with the requirements in : IEC60601-2-27: Clause 201.7.9.2.9.101 b) 4), the heart rate after 20 seconds of stabilization is displayed as follows:</p> <p>Ventricular bigeminy (3a): -80 ± 1 bpm</p> <p>Slow alternating ventricular bigeminy (3b): -60 ± 1 bpm</p> <p>Rapid alternating ventricular bigeminy (3c): -120 ± 1 bpm</p> <p>Bidirectional systoles (3d): -90 ± 2 bpm</p>		
Response time to heart rate change	<p>Meets the requirements of IEC60601-2-27: Clause 201.7.9.2.9.101 b) 5).</p> <p>From 80 to 120 bpm: less than 11 s</p> <p>From 80 to 40 bpm: less than 11 s</p>		
Time to alarm for tachycardia	Meets the requirements of IEC60601-2-27: Clause 201.7.9.2.9.101 b) 6).		

	Waveform 4ah - range: < 11 s 4a - range: < 11 s 4ad - range: < 11 s 4bh - range: < 11 s 4b - range: < 11 s 4bd - range: < 11 s	
Tall T-wave rejection capability	When the test is performed based on IEC60601-2-27: Clause 201.12.1.101.17, the maximum T-wave amplitude that can be rejected is 1.2mV.	
Arrhythmia alarms	Asystole, VFib/VTac, Vtac, Vent. Brady, Extreme Tachy, Extreme Brady, PVCs/min, Couplet, Bigeminy, Trigeminy, R on T, Run PVCs, PVC, Tachy, Brady, Missed Beats, Vent. Rhythm, Pacer Not Pacing, Pacer Not Capture, Multif. PVC, Nonsus. Vtac, Pause, Irr. Rhythm, AFib	
ST Segment Analysis		
Measurement range	-2.0 to 2.0 mV RTI	
Accuracy	-0.8 to 0.8 mV: ±0.02 mV or ±10%, whichever is greater. Beyond this range: Not specified.	
QT/QTc Interval Monitoring		
Measurement range	QT: 200 – 800 ms QTc: 200 – 800 ms QT-HR: 15 – 150 bpm for adult, 15 – 180 bpm for pediatric and neonate	
Accuracy	QT: ± 30 ms	
Resolution	QT: 4 ms QTc: 1 ms	
Alarm limit	Range	Step
HR High	(low limit + 2) to 300 bpm	HR≤40: 1bpm HR>40: 5 bpm
HR Low	15 to (high limit – 2) bpm	
ST High	(low limit +0.2) to 2.0 mV	0.1mV
ST Low	-2.0 to (high limit – 0.2) mV	
QT/QTc alarm limit	Range (bpm)	Step (ms)
QTc High	200 – 800 ms	10
Δ QTc High	30 – 200 ms	

A.6.2 Resp

Technique	Trans-thoracic impedance	
Lead	Options are lead I and II.	
Respiration excitation waveform	<300 μ A RMS, ,62.8 kHz (\pm 10%)	
Respiration impedance range	0.3 to 5 Ω	
Baseline impedance range	200 to 2500 Ω (using an ECG cable with 1k Ω resistance)	
Differential input impedance	>2.5 M Ω	
Bandwidth	0.2 to 2.5 Hz (-3 dB)	
Sweep speed	3mm/s, 6.25 mm/s, 12.5 mm/s, 25 mm/s or 50 mm/s	
Respiration Rate		
Measurement range	Adult: 0 to 120 rpm Pediatric, neonate: 0 to 150 rpm	
Resolution	1 rpm	
Accuracy	7 to 150 rpm: \pm 2 rpm or \pm 2%, whichever is greater 0 to 6 rpm: Not specified.	
Apnea alarm time	10 s, 15 s, 20 s, 25 s, 30 s, 35 s, 40 s	
Alarm limit	Range (rpm)	Step (rpm)
RR High	Adult, pediatric: (low limit + 2) to 100 Neonate: (low limit + 2) to 150	1
RR Low	0 to (high limit - 2)	

A.6.3 SpO₂

Alarm limit	Range (%)	Step (%)
SpO ₂ High	(low limit + 2) to 100	1
SpO ₂ Low	Masimo: Desat to (high limit - 2) Nellcor: Desat or 20 (whichever is greater) to (high limit - 2)	
Desat	0 to (high limit - 2)	

Masimo SpO₂ Module

SpO ₂	
Standards	Meet ISO9919 standards
Measurement range	1 to 100%
Resolution	1%
Response time	≤ 20 s (PR 75 bpm, average time 8 s, SpO ₂ value rises from 60% to 95%)
Accuracy ¹	70 to 100%: ±2% (measured without motion in adult/pediatric mode) 70 to 100%: ±3% (measured without motion in neonate mode) 70 to 100%: ±3% (measured with motion) 1% to 69%: Not specified.
Refreshing rate	≤ 2 s
SpO ₂ averaging time	2-4 s, 4-6 s, 8 s, 10 s, 12 s, 14 s, 16 s
Low perfusion conditions	Pulse amplitude: >0.02% Light penetration: >5%
Low perfusion SpO ₂ accuracy ²	±2%
PI measurement range	0.02 to 20%
<p>¹ The Masimo pulse oximeter with sensors have been validated for no motion accuracy in human blood studies on healthy adult volunteers in induced hypoxia studies in the range of 70% to 100% SpO₂ against a laboratory co-oximeter and ECG monitor. This variation equals plus or minus one standard deviation. Plus or minus one standard deviation encompasses 68% of the population. One percent was added to the accuracies for neonatal sensors to account for accuracy variation due to properties of fetal hemoglobin.</p> <p>The Masimo pulse oximeter with sensors has been validated for motion accuracy in human blood studies on healthy adult volunteers in induced hypoxia studies while performing rubbing and tapping motions at 2 to 4 Hz. At an amplitude of 1 to 2 cm and non-repetitive motion between 1 to 5 Hz. At an amplitude of 2 to 3 cm in induced hypoxia studies in the range of 70% to 100% SpO₂ against a laboratory co-oximeter and ECG monitor. This variation equals plus or minus one standard deviation. Plus or minus one standard deviation encompasses 68% of the population.</p> <p>² The Masimo pulse oximeter has been validated for low perfusion accuracy in bench top testing against a Biotek Index 2 simulator and Masimo's simulator with signal strengths of greater than 0.02% and a % transmission of greater than 5% for saturations ranging from 70 to 100%. This variation equals plus or minus one standard deviation. Plus or minus one standard deviation encompasses 68% of the population.</p>	

Nellcor SpO₂ Module

Measurement range	0 to 100%
Resolution	1%
Response time	≤ 30 s (PI > 0.3, no disturbance, SpO ₂ value sudden change within 70% - 100%)
Refreshing rate	≤ 2 s
Accuracy	70 to 100%: ±2% (adult/pediatric) 70 to 100%: ±3% (neonate) 0% to 69%: Not specified.
<p>When the SpO₂ sensor is applied for neonatal patients as indicated, the specified accuracy range is increased by ±1%, to compensate for the theoretical effect on oximeter measurements of fetal hemoglobin in neonatal blood.</p>	

Information of the Test Subjects of the Clinical Study Report:

Skin color	Gender	Number	Age (years)	Health
Black	Male	1	28.2 ± 9.19	Healthy
	Female	1		
Yellow	Male	3		
	Female	9		

A.6.4 PR

Alarm limit	Range (bpm)	Step (bpm)
PR High	(low limit +2) to 300	1
PR Low	15 to (high limit-2)	

PR from Masimo SpO₂ Module

Measurement range	25 to 240 bpm
Resolution	1 bpm
Response time	≤ 30 s (PI > 0.3, no disturbance, PR value sudden change within 25 – 240 bpm)
Accuracy	±3 bpm (measured without motion) ±5 bpm (measured with motion)

PR from Nellcor SpO₂ Module

Measurement range	20 to 300 bpm
Resolution	1 bpm
Response time	≤ 30 s (PI > 0.3, no disturbance, PR value sudden change within 25 – 250 bpm)
Accuracy	20 to 250 bpm: ±3 bpm 251 to 300 bpm, not specified

PR from IBP Module

Measurement range	25 to 350 bpm
Resolution	1 bpm
Accuracy	±1 bpm or ±1%, whichever is greater

A.6.5 NIBP

Standards	Meet standards of IEC 80601-2-30			
Technique	Oscillometry			
Mode of operation	Manual, Auto and STAT			
Auto mode repetition intervals	1, 2, 2.5, 3, 5, 10, 15, 20, 30, 60, 90, 120, 180, 240 or 480 min			
STAT mode cycle time	5 min			
Max measurement time	Adult, pediatric: 180 s Neonate: 90 s			
Measurement ranges (mmHg)		Adult	Pediatric	Neonate
	Systolic:	25 to 290	25 to 240	25 to 140
	Diastolic:	10 to 250	10 to 200	10 to 115
	Mean:	15 to 260	15 to 215	15 to 125
Accuracy	Max mean error: ± 5 mmHg Max standard deviation: 8 mmHg			
Resolution	1mmHg			
Initial cuff inflation pressure range (mmHg)	Adult: 80 to 280 Pediatric: 80 to 210 Neonate: 60 to 140			
Default initial cuff inflation pressure (mmHg)	Adult: 160 Pediatric: 140 Neonate: 90			
Software overpressure protection	Adult: 297 ± 3 mmHg Pediatric: 297 ± 3 mmHg Neonate: 147 ± 3 mmHg			
Static pressure measurement range	0 mmHg to 300 mmHg			
Static pressure measurement accuracy	± 3 mmHg			
PR				
Measurement range	30 to 300 bpm			
Resolution	1 bpm			
Accuracy	± 3 bpm or $\pm 3\%$, whichever is greater			
Alarm limit	Range (mmHg)			Step (mmHg)
Sys High	Adult: (low limit+5) to 290 Pediatric: (low limit+5) to 240 Neonate: (low limit+5) to 140			5
Sys Low	25 to (high limit-5)			
Mean High	Adult: (low limit+5) to 260 Pediatric: (low limit+5) to 215 Neonate: (low limit+5) to 125			
Mean Low	15 to (high limit-5)			
Dia High	Adult: (low limit+5) to 250 Pediatric: (low limit+5) to 200 Neonate: (low limit+5) to 115			
Dia Low	10 to (high limit-5)			

Measurement accuracy verification: In adult and pediatric modes, the blood pressure measurements measured with this device are in compliance with the Standard for Non-invasive sphygmomanometers (ISO 81060-2) in terms of mean error and standard deviation by comparing with intra-arterial or auscultatory measurements (depending on the configuration) in a typical patient population. For auscultatory reference, the 5th Korotkoff sound was used to determine the diastolic pressure.

In neonatal mode, the blood pressure measurements measured with this device are in compliance with the American National Standard for Non-invasive sphygmomanometers (ISO 81060-2) in terms of mean error and standard deviation by comparing with intra-arterial measurements (depending on the configuration) in a typical patient population.

A.6.6 Temp

Standards	Meet standard of ISO 80601-2-56	
Technique	Thermal resistance	
Operating mode	Direct mode	
Measurement range	0 to 50 °C (32 to 122°F)	
Resolution	0.1 °C	
Accuracy	±0.1 °C or ±0.2 °F (without probe)	
Minimum time for accurate measurement	Body surface: <100 s Body cavity: <80 s	
Minimum time between measurements	Body surface probe: <100 s Body cavity probe: <80 s	
Alarm limit	Range	Step
T1/T2 High	(low limit +1) to 50 °C (low limit +1.8) to 122 °F	0.1 °C 0.1°F
T1/T2 Low	0.1 to (high limit -1) °C 32 to (high limit -1.8) °F	
TD High	0.1 to 50°C 0 to 90°F	

A.6.7 IBP

Standards	Meet standard of EN60601-2-34/IEC60601-2-34.
Technique	Direct invasive measurement
IBP	
Measurement range	-50 to 300 mmHg
Resolution	1 mmHg
Accuracy	±2% or ±1 mmHg, whichever is greater (without sensor)
PPV	
Measurement range	0% ~ 50%
Pressure transducer	
Excitement voltage	5 VDC, ±2%
Sensitivity	5 µV/V/mmHg
Zero adjustment range	± 200 mmHg
Impedance range	300 to 3000Ω
Volume displacement (ABBOTT)	<0.04 mm ³ /100 mmHg

Alarm limit	Range (mmHg)	Step (mmHg)
Sys High	(low limit + 2) to 300	1
Mean High		
Dia High		
Sys Low	-50 to (high limit - 2)	
Mean Low		
Dia Low		

A.6.8 C.O.

Measurement method	Thermodilution method	
Measurement range	C.O.:	0.1 to 20 L/min
	TB:	23 to 43 °C
	TI:	0 to 27 °C
Resolution	C.O.:	0.1 L/min
	TB, TI:	0.1 °C
Accuracy	C.O.:	±5% or ±0.1 L/min, whichever is greater
	TB, TI:	±0.1 °C (without sensor)
Repeatability	C.O.:	±2% or ±0.1 L/min, whichever is greater
Alarm range	TB:	23 to 43 °C
Alarm limit	Range	Step
TB High	(low limit + 1) to 43 °C (low limit + 1.8) to 109.4°F	0.1 °C
TB Low	23 to (high limit - 1) °C 73.4 to (high limit - 1.8) °F	0.1 °F

A.6.9 CCO

Operating mode	Interfaces with Edwards Vigilance II® monitor, Vigileo™ monitor, or EV1000 monitor
Measured parameter	Consistent with CCO-related parameters output by Vigilance II® monitor, Vigileo™ monitor, or EV1000 monitor
Parameter alarm	Vigilance II®: CCO/CCI, EDV/EDVI, SVR/SVRI, SV/SVI, RVEF Vigileo™: CCO/CCI, SV/SVI, SVV, SVR/SVRI EV1000: CCO/CCI, SVR/SVRI, SV/SVI, SVV

Signal Outputs for Vigilance II Monitor	
Standard	Meets the requirements of EN 60601-1 for short-circuit protection and leakage current
Output impedance	≤ 1000Ω
Isolation voltage	1500 VAC
ECG Analog Output	

Bandwidth (-3dB; reference frequency: 10Hz)	ST mode: 0.05~40Hz Diagnostic mode: 0.05~150Hz Monitor mode: 0.5~40Hz Surgical mode: 1~20Hz
Delay (QRS complex delay)	≤200ms
Sensitivity	2V/mV (±5%)
Baseline	5V±15mV
MAP Analog Signal Output	
Output voltage	0 to 5V (0 to 500mmHg)
Output voltage error	±5%
CVP Analog Signal Output	
Output voltage	0 to 5V (0 to 100mmHg)
Output voltage error	±5%

Signal Outputs for Vigileo™ Monitor	
Standard	Meets the requirements of EN 60601-1 for short-circuit protection and leakage current
Output impedance	≤ 1000Ω
Isolation voltage	1500 VAC
CVP Analog Signal Output	
Output voltage	0 to 5V (0 to 100mmHg)
Output voltage error	±5%

A.6.10 SvO₂

Operating mode	Interfaces with Edwards Vigilance II® monitor, Vigileo™ monitor, or EV1000 monitor
Measured parameter	Consistent with CCO-related parameters output by Vigilance II® monitor, Vigileo™ monitor, or EV1000 monitor
Parameter alarm	Vigilance II® monitor, Vigileo™ monitor, and EV1000 monitor:: SvO ₂ , ScvO ₂

Signal Outputs for Vigilance II Monitor	
Standard	Meets the requirements of EN 60601-1 for short-circuit protection and leakage current
Output impedance	≤ 1000Ω
Isolation voltage	1500 VAC
SpO₂ Analog Signal Output	
Output voltage	0 to 10V (0 to 100%)
Output voltage error	±5%

A.6.11 ScvO₂

Measured parameters	Measurement range	Measurement accuracy
ScvO ₂	0 to 99%	50% to 80%: ±3% Other ranges: Not specified.

A.6.12 CO₂

Measurement mode	Sidestream, microstream	
Technique	Infrared absorption	
Apnea delay time	10 s, 15 s, 20 s, 25 s, 30 s, 35 s, 40 s	
Alarm limit	Range	Step
EtCO ₂ High	(low limit + 2) to 99 mmHg	1 mmHg
EtCO ₂ Low	1 to (high limit - 2)mmHg	
FiCO ₂ High	1 to 99 mmHg	
awRR High	Adult, pediatric: (low limit + 2) to 100 rpm Neonate: (low limit + 2) to 150 rpm	1 rpm
awRR Low	0 to (high limit - 2) rpm	

Sidestream CO₂ Module

Standard	Meet standard of ISO 80601-2-55
CO ₂ Measurement range	0 to 99 mmHg
Accuracy*	0 to 40 mmHg: ±2 mmHg 41 to 76 mmHg: ±5% of the reading 77 to 99 mmHg: ±10% of the reading
Accuracy drift	Meet the requirement for measurement accuracy within 6 hours
Resolution	1 mmHg
Sample flowrate	Adult: 70 ml/min, 100 ml/min, 120 ml/min, 150 ml/min Pediatric, neonate: 70 ml/min, 100 ml/min
Sample flowrate tolerance	15% or 15 ml/min, whichever is greater.
Warm-up time	1 min
Response time	Measured with a neonatal watertrap and a 2.5-meter neonatal sampling line: <3.5 s @ 100 ml/min <4 s @ 70 ml/min Measured with a adult watertrap and a 2.5-meter adult sampling line: <4.5 s @ 150 ml/min <5.5 s @ 120 ml/min <5.5 s @ 100 ml/min <7 s @ 70 ml/min
Gas sampling delay time	Measured with a neonatal watertrap and a 2.5-meter neonatal sampling line: <3 s @ 100 ml/min <3.5 s @ 70 ml/min Measured with a adult watertrap and a 2.5-meter adult sampling line: <4 s @ 150 ml/min <5 s @ 120 ml/min <5 s @ 100 ml/min <6.5 s @ 70 ml/min
awRR measurement range	0 to 120 rpm
awRR measurement precision	±2 rpm

Effect of interference gases on CO ₂ measurements		
Gas	Concentration (%)	Quantitative effect*
N ₂ O	≤60	±1 mmHg
Hal	≤4	
Sev	≤5	
Iso	≤5	
Enf	≤5	
Des	≤15	±2 mmHg

*: means an extra error should be added in case of gas interference when CO₂ measurements are performed between 0-40mmHg.

Inaccuracy specifications are affected by the breath rate and I:E change. The end-tidal gas reading is within specification for breath rate below 15BPM and I:E ratio smaller than 1:1 relative to the gas readings without breath.

Microstream CO₂ Module

Standard	Meet standard of ISO 80601-2-55	
CO ₂ Measurement range	0 to 99 mmHg	
Accuracy*	0 to 38 mmHg:	±2 mmHg
	39 to 99 mmHg:	±5% of the reading+0.08% of (the reading-38)
Accuracy drift	Meet the requirement for measurement accuracy within 6 hours	
*This accuracy is applied to respiration rate no greater than 80 rpm. For respiration rate greater than 80 rpm and EtCO ₂ value greater than 18mmHg, the accuracy is 4 mmHg or ±12% of the reading, whichever is greater. For respiration rate greater than 60 rpm, the above accuracy can be achieved by using the CapnoLine H Set for Infant/Neonatal. In the presence of interfering gases, the accuracy specification deteriorates by 4% of the above accuracy.		
Resolution	1 mmHg	
Sample flow rate	50 ^{-7.5} ₊₁₅ ml/min	
Initialization time	180 s (maximum)	
Response time	2.9 s (typical) (The response time is the sum of the rise time and the delay time when using a FilterLine of standard length) Rise time: <190 ms (10% to 90%) Delay time: 2.7 s (typical)	
awRR measurement range	0 to 150 rpm	
awRR measurement accuracy	0 to 70 rpm:	±1 rpm
	71 to 120 rpm:	±2 rpm
	121 to 150 rpm:	±3 rpm

A.6.13 tcGas

Operating mode	Interfaces with TCM CombiM or TCM TOSCA monitor	
Parameters	Measurement range	Measurement accuracy
tcpCO ₂	5 to 200 mmHg (0.7 to 26.7 kPa)	TOSCA Sensor 92, tc Sensor 54: 1 % CO ₂ : better than 1 mmHg (0.13 kPa) 10 % CO ₂ : better than 1 mmHg (0.13 kPa) 33 % CO ₂ : better than 3 mmHg (0.4 kPa) tc Sensor 84: 1 % CO ₂ : better than 1 mmHg (0.13 kPa) 10 % CO ₂ : better than 1 mmHg (0.13 kPa) 33 % CO ₂ : better than 5 mmHg (0.67 kPa)
tcpO ₂	0 to 800 mmHg (0.0 to 99.9 kPa)	tc Sensor 84: 0 % O ₂ : better than 1 mmHg (0.13 kPa) 21 % O ₂ : better than 3 mmHg (0.4 kPa) 50 % O ₂ : better than 5 mmHg (0.67 kPa) 90 % O ₂ : better than 25 mmHg (3.33 kPa)
SpO ₂	0 to 100 %	70 % to 100 %: ± 3 %
PR	25 bpm to 240 bpm	± 3 bpm
Power	0 to 1000 mW	± 20 % of reading

A.6.14 AG

Standards	Meet standard of ISO 80601-2-55		
Technique	Infrared absorption		
Warm-up time	Iso accuracy mode:	≤ 45 s	
	Full accuracy mode:	≤ 10 min	
Sample flow rate	Adult, pediatric:	120, 150, 200 ml/min	
	Neonate:	70, 90, 120 ml/min	
	Accuracy:	±10 ml/min or ±10%, whichever is greater	
Measurement range	CO ₂ :	0 to 30%	
	O ₂ :	0 to 100%	
	N ₂ O:	0 to 100%	
	Des:	0 to 30%	
	Sev:	0 to 30%	
	Enf:	0 to 30%	
	Iso:	0 to 30%	
	Hal:	0 to 30%	
	awRR:	2 to 100 rpm	
Resolution	CO ₂ :	1 mmHg	
	awRR:	1 rpm	
Iso accuracy	CO ₂ :	±0.3% _{ABS}	
	N ₂ O:	±(8% _{REL} +2% _{ABS})	
	Other anesthetic gases:	8% _{REL}	
Full accuracy	Gases	Range (%_{REL})¹	Accuracy (%_{ABS})

	CO ₂	0 to 1 1 to 5 5 to 7 7 to 10 >10	±0.1 ±0.2 ±0.3 ±0.5 Not specified
	N ₂ O	0 to 20 20 to 100	±2 ±3
	O ₂	0 to 25 25 to 80 80 to 100	±1 ±2 ±3
	Des	0 to 1 1 to 5 5 to 10 10 to 15 15 to 18 >18	±0.15 ±0.2 ±0.4 ±0.6 ±1 Not specified
	Sev	0 to 1 1 to 5 5 to 8 >8	±0.15 ±0.2 ±0.4 Not specified
	Enf, Iso, Hal	0 to 1 1 to 5 >5	±0.15 ±0.2 Not specified
	awRR	2 to 60 rpm >60 rpm	±1 rpm Not specified
	Note ¹ : The highest GAS LEVEL for a single halogenated anaesthetic gas in a gas mixture that is concealed when the anaesthetic concentration falls is 0.15/0.3% (Full/ISO accuracy).		
Accuracy drift	Meet the requirement for measurement accuracy within 6 hours		
Apnea alarm time	10 s, 15 s, 20 s, 25 s, 30 s, 35 s, 40 s		
Rise time (10 % ~ 90%)	gas sample flow rate 120ml/min, using the DRYLINE™ or DRYLINE II watertrap and neonatal DRYLINE™ sampling line (2.5m):		
	CO ₂	≤250 ms (fall time ≤ 200ms)	
	N ₂ O	≤250 ms	
	O ₂	≤600 ms	
	Hal, Iso, Sev, Des	≤300 ms	
	Enf	≤350 ms	
	gas sample flow rate 200ml/min, using the DRYLINE™ or DRYLINE II water trap and adult DRYLINE™ sampling line (2.5m):		
	CO ₂	≤250 ms (fall time ≤ 200 ms)	
	N ₂ O	≤250 ms	
	O ₂	≤500 ms	
	Hal, Iso, Sev, Des	≤300 ms	
	Enf	≤350 ms	
Delay time	<4 s		

Response time	Measured with a neonatal watertrap and a 2.5-meter neonatal sampling line: 120 ml/min: CO ₂ : ≤4s N ₂ O: ≤4.2s O ₂ : ≤4s HAL/ISO/SEV/DES/ENF: ≤4.4s
Anesthetic agent limit	Primary anesthetic agent In full accuracy mode: 0.15% In ISO accuracy mode: 0.4%
	Second anesthetic agent: In full accuracy mode: 0.3% or 5% REL (10% _{REL} for Isoflurane) of primary agent if primary agent is greater than 10% In ISO accuracy mode: 0.5%

Inaccuracy specifications are affected by the breath rate and I:E change. The end-tidal gas reading is within specification for breath rate below 15BPM and I:E ratio smaller than 1:1 relative to the gas readings without breath; Add ±6%_{REL} to inaccuracy for HAL and O₂ for breath rate larger than 15 BPM; Add ±6%_{REL} to inaccuracy for all gases for breath rate larger than 30 BPM (inaccuracy for HAL and O₂ are unspecified in this case); inaccuracy is unspecified for breath rate larger than 60 BPM.

Effect of interference gases on AG measurements

Gas	Concentration(%)	Quantitive effect(% _{ABS}) ³⁾			
		CO ₂	N ₂ O	Agent ¹⁾	O ₂
CO ₂	/	/	0.1	0	0.2
O ₂	/	0.1	0.1	0.1	/
N ₂ O	/	0.1	/	0.1	0.2
Agent ¹⁾²⁾	/	0.1	0.1 ⁵⁾	0.1 ⁴⁾	1
Xenon	<100%	0.1	0	0	0.5
Helium	<50%	0.1	0	0	0.5
Ethanol	<0.1%	0	0	0	0.5
Acetone	<1%	0.1	0.1	0	0.5
Methane	<1%	0.1	0.1	0	0.5
Saturated Isopropanol vapour	/	0.1	0	0	0.5
Metered dose inhaler propellants,	/	Unspecified	Unspecified	Unspecified	0.5

1) Agent represents one of Des, Iso, Enf, Sev, and Hal.

2) Multiple agent interference on CO₂, N₂O and O₂ is typically the same as single agent interference.

3) For CO₂, N₂O and Agents, maximum interference from each gas at concentrations within specified accuracy ranges for each gas. The total interference of all gases is never larger than 5%_{REL}.

4) Applicable to type A AG module, representing the interference effect of secondary anesthetic agents on primary anesthetic agent.

5) Measurement interference to type M AG module originates from the applied anesthetic agent that is configured manually.

Alarm limit	Range	Step	
EtCO ₂ High	(low limit + 2) to 99 mmHg	1 mmHg	
EtCO ₂ Low	1 to (high limit - 2)mmHg		
FiCO ₂ High	1 to 99 mmHg		
awRR High	Adult, pediatric: Neonate:	(low limit + 2) to 100 rpm (low limit + 2) to 150 rpm	1 rpm

awRR Low	0 to (high limit - 2)rpm	
EtO ₂ High	(low limit + 2) to 100 %	1%
EtO ₂ Low	0% to (high limit - 2)%	
FiO ₂ High	(low limit + 2) to 100 %	
FiO ₂ Low	18% to (high limit - 2)%	
EtN ₂ O High	(low limit + 2) to 100 %	
EtN ₂ O Low	0 to (high limit - 2)%	1%
FiN ₂ O High	(low limit + 2) to 100 %	
FiN ₂ O Low	0 to (high limit - 2)%	
EtHal/Enf/Iso High	(low limit + 0.2) to 5.0 %	
EtHal/Enf/Iso Low	0 to (high limit - 0.2)%	0.1%
FiHal/Enf/Iso High	(low limit + 0.2) to 5.0 %	
FiHal/Enf/Iso Low	0 to (high limit - 0.2)%	
EtSev High	(low limit + 0.2) to 8.0 %	
EtSev Low	0 to (high limit - 0.2)%	0.1%
FiSev High	(low limit + 0.2) to 8.0 %	
FiSev Low	0 to (high limit - 0.2)%	
EtDes High	(low limit + 0.2) to 18.0 %	
EtDes Low	0 to (high limit - 0.2)%	0.1%
FiDes High	(low limit + 0.2) to 18.0 %	
FiDes Low	0 to (high limit - 0.2)%	

A.6.15 BIS

Standards	Meet standard of IEC 60601-2-26
Technique	Bispectral index
Measured parameters	EEG BIS, BIS L, BIS R: 0 to 100
Calculated parameters	SQI, SQI L, SQI R: 0 to 100% EMG, EMG L, EMG R: 0 to 100 dB SR, SR L, SR R: 0 to 100% SEF, SEF L, SEF R: 0.5 to 30.0 Hz TP, TP L, TP R: 40 to 100 dB BC, BC L, BC R: 0 to 30 sBIS L, sBIS R: 0 to 10.0 sEMG L, sEMG R: 0 to 10.0 ASYM: 0 to 100%
Impedance range	0 to 999 kΩ
Sweep speed	6.25 mm/s, 12.5 mm/s, 25 mm/s or 50 mm/s
Input impedance	>5 MΩ

Noise (RTI)	<0.3 μ V (0.25 to 50 Hz)	
Input signal range	\pm 1 mV	
EEG bandwidth	0.25 to 100 Hz	
Patient leakage current	<10 μ A	
Alarm limit	Range	Step
BIS High	(low limit + 2) to 100	1
BIS Low	0 to (high limit – 2)	

A.6.16 NMT

NMT from Mindray NMT module

Stimulation output	Pulse width	100, 200, or 300 μ s; monophasic rectangle pulse Accuracy: \pm 10%
	Current range	0 - 60 mA in increments of 5 mA Accuracy: \pm 5% or \pm 2 mA, whichever is greater
	Max. skin impedance	3 k Ω @ 60 mA, 5 k Ω @ 40 mA
	Max. output voltage	300 V
ST mode	ST-Ratio	0 - 200%
	Measurement interval	Manual, 1 s, 10 s, 20 s
TOF mode	TOF-Count	0 - 4
	TOF-Ratio	5 - 160%
	Measurement interval	Manual, 12s, 15s, 20s, 30s, 1min, 5min, 15min, 30min, 60min
PTC mode	PTC	0 - 20
	Measurement interval	Manual
DBS mode	Measurement interval	Manual, 15s, 20s, 30s, 1min, 5min, 15min, 30min, 60min
	DBS-Count	0 - 2
	DBS-Ratio	5 - 160%
NMT Block Recovery threshold	Off, 1, 2, 3, 4, 5%, 10%, 20%, 30%, 40%, 50%, 60%, 70%, 80%, 90%, 100%	

NMT from TOF-Watch® SX monitor

Operating mode	Interfaces with TOF-Watch® SX monitor
Parameters	Measurement range
TOF-Ratio	1% to 160%
TOF-Count	0 to 4
Single	0% to 160%
PTC	0 to 15
Tskin	20.0 °C to 41.5 °C

A.6.17 RM

Technique	Flow sensor
Frequency response	≥30 Hz
Dead space	≤11 ml
Flow	
Measurement range	Adult/pediatric*: ± (2 to 120) L/min Infant: ± (0.5 to 30) L/min
Accuracy	Adult/pediatric*: 1.2 L/min or ±10% of the reading, whichever is greater Infant: 0.5 L/min or ±10% of the reading, whichever is greater
Resolution	0.1 L/min
Paw	
Measurement range	-20 to 120 cmH ₂ O
Accuracy	±3%×reading
Resolution	0.1 cmH ₂ O
MVe/MVi	
Measurement range	Adult/Pediatric*: 2 to 60 L/min Infant: 0.5 to 15 L/min
Accuracy	±10%×reading
TVe/TVi	
Measurement range	Adult/Pediatric*: 100 to 1500 ml Infant: 20 to 500 ml
Resolution	1 ml
Accuracy	Adult/pediatric*: ±10% × reading or ± 15 ml, whichever is greater Infant: ±10% × reading or ± 6 ml, whichever is greater
RR (RM)	
Measurement range	4 to 120 rpm
Accuracy	4 to 99 rpm ±1 rpm 100 to 120 rpm ±2 rpm

*Pediatric in this form does not include neonate and infant.

Calculated Parameters		
	Measurement range	Measurement accuracy
I:E	4:1 to 1:8	Not specified.
FEV1.0%	0 to 100%	Not specified.
Pmean	0 to 120 cmH ₂ O	±10%×reading
TV	20 to 1500 ml	Adult/pediatric: ±10% × reading or ±15 ml, whichever is greater. Infant: ±10% × reading or ±6 ml, whichever is greater.
MV	0.5 to 60 L	±10%×reading
PEEP	0 to 120 cmH ₂ O	Not specified.
PEF	2 to 120 L/min	±10% × reading
PIF	2 to 120 L/min	±10% × reading
PIP	0 to 120 cmH ₂ O	±10% × reading
Pplat	0 to 120 cmH ₂ O	Not specified.
Compl	0 to 200 ml/cmH ₂ O	
RSBI	0 to 4095 rpm/L	
Alarm limit	Range	Step
RR High	Adult, pediatric: (low limit + 2) to 100 rpm Neonate: (low limit + 2) to 150 rpm	1 rpm
RR Low	0 to (high limit - 2) rpm	
PEEP High	(low limit + 1) to 120 cmH ₂ O	1 cmH ₂ O
PEEP Low	0 to (high limit - 1) cmH ₂ O	
PIP High	(low limit + 1) to 120 cmH ₂ O	1 cmH ₂ O
PIP Low	1 to (high limit - 1) cmH ₂ O	
MVe High	(low limit + 1.0) to 60.0 L/min	0.5 L/min
MVe Low	0.5 to (high limit - 1.0)	

FOR YOUR NOTES

B EMC and Radio Regulatory Compliance

B.1 EMC

The device meets the requirements of IEC 60601-1-2. All the accessories listed in Chapter 36 also meet the requirements of IEC 60601-1-2 when in use with this device.

CAUTIONS

- **Using accessories, transducers and cables other than those specified may result in increased electromagnetic emission or decreased electromagnetic immunity of the equipment.**
- **The device or its components should not be used adjacent to or stacked with other equipment. If adjacent or stacked use is necessary, the device or its components should be observed to verify normal operation in the configuration in which it will be used.**
- **The device needs special precautions regarding EMC and needs to be installed and put into service according to the EMC information provided below.**
- **Other devices may interfere with this device even though they meet the requirements of CISPR.**
- **When the inputted signal is below the minimum amplitude provided in technical specifications, erroneous measurements could result.**
- **Portable and mobile communication equipment may affect the performance of this device.**
- **Other devices that have RF transmitter or source may affect this device (e.g. cell phones, PDAs, and PCs with wireless function).**

Guidance and Declaration - Electromagnetic Emissions		
The device is intended for use in the electromagnetic environment specified below. The customer or the user of the device should assure that it is used in such an environment.		
Emission tests	Compliance	Electromagnetic environment - guidance
Radio frequency (RF) emissions CISPR 11	Group 1	The device uses RF energy only for its internal function. Therefore, its RF emissions are very low and are not likely to cause any interference in nearby electronic equipment.
RF emissions CISPR 11	Class A	The device is suitable for use in all establishments other than domestic and those directly connected to the public low-voltage power supply network that supplies buildings used for domestic purposes.
Harmonic emissions IEC61000-3-2	Class A	
Voltage Fluctuations/Flicker Emissions IEC 61000-3-3	Complies	



WARNING

- **This equipment/system is intended for use by healthcare professionals only. This equipment/ system may cause radio interference or may disrupt the operation of nearby equipment. It may be necessary to take mitigation measures, such as re-orienting or relocating the [ME EQUIPMENT or ME SYSTEM] or shielding the location.**

If the system is operated within the electromagnetic environment listed in **Table Guidance and declaration** — **electromagnetic immunity**, the system will remain safe and provide the following essential performance,

- Operating mode
- Accuracy
- Function
- Accessories identification
- Data stored
- Alarm
- Detect for connection

Guidance and Declaration - Electromagnetic Immunity			
The device is intended for use in the electromagnetic environment specified below. The customer or the user of the device should assure that it is used in such an environment.			
Immunity test	IEC60601 test level	Compliance level	Electromagnetic environment - guidance
Electrostatic discharge (ESD) IEC 61000-4-2	±6 kV contact ±8 kV air	±6 kV contact ±8 kV air	Floors should be wood, concrete or ceramic tile. If floors are covered with synthetic material, the relative humidity should be at least 30%.
Electrical fast transient/burst IEC 61000-4-4	±2 kV for power supply lines ±1 kV for input/output lines	±2 kV for power supply lines ±1 kV for input/output lines	Mains power quality should be that of a typical commercial or hospital environment.
Surge IEC 61000-4-5	±1 kV line(s) to line(s) ±2 kV line(s) to earth	±1 kV line(s) to line(s) ±2 kV line(s) to earth	
Voltage dips, short interruptions and voltage variations on power supply input lines IEC 61000-4-11	<5 % U_T (>95 % dip in U_T) for 0.5 cycle 40 % U_T (60 % dip in U_T) for 5 cycles 70 % U_T (30 % dip in U_T) for 25 cycles <5 % U_T (>95 % dip in U_T) for 5 s	<5 % U_T (>95 % dip in U_T) for 0.5 cycle 40 % U_T (60 % dip in U_T) for 5 cycles 70 % U_T (30 % dip in U_T) for 25 cycles <5 % U_T (>95 % dip in U_T) for 5 s	Mains power quality should be that of a typical commercial or hospital environment. If the user of our product requires continued operation during power mains interruptions, it is recommended that our product be powered from an uninterruptible power supply or a battery.

Power frequency (50/60 HZ) magnetic field IEC 61000-4-8	3 A/m	3 A/m	Power frequency magnetic fields should be at levels characteristic of a typical location in a typical commercial or hospital environment.
---------------------------------------------------------	-------	-------	-------------------------------------------------------------------------------------------------------------------------------------------

Note: U_T is the AC mains voltage prior to application of the test level.

Guidance and Declaration - Electromagnetic Immunity

The device is intended for use in the specified electromagnetic environment. The customer or the user of the device should assure that it is used in such an environment as described below.

Immunity test	IEC60601 test level	Compliance level	Electromagnetic environment - guidance
Conducted RF IEC61000-4-6	3 Vrms 150 kHz to 80MHz	3Vrms (BIS, ICG: 1Vrms)	Portable and mobile RF communications equipment should be used no closer to any part of the system, including cables, than the recommended separation distance calculated from the equation appropriate for the frequency of the transmitter. Recommended separation distances: $d = 1.2\sqrt{P}$ For BIS, ICG: $d = 3.5\sqrt{P}$
Radiated RF IEC61000-4-3	3V/m 80MHz to 2.5GHz	3V/m (Resp: 1V/m)	Recommended separation distances: 80 MHz~800 MHz $d = 1.2\sqrt{P}$ (Resp: $d = 3.5\sqrt{P}$) 800MHz-2.5GHz $d = 2.3\sqrt{P}$ (Resp: $d = 7\sqrt{P}$) Where, P is the maximum output power rating of the transmitter in watts (W) according to the transmitter manufacturer and d is the recommended separation distance in meters (m). ^b Field strengths from fixed RF transmitters, as determined by an electromagnetic site survey ^a , should be less than the compliance level in each frequency range ^b . Interference may occur in the vicinity of equipment marked with the following symbol: 

Note 1: At 80 MHz to 800 MHz, the separation distance for the higher frequency range applies.

Note 2: These guidelines may not apply in all situations. Electromagnetic propagation is affected by absorption and reflection from structures, objects and people.

Note 3: The device that intentionally receives RF electromagnetic energy at the exclusion band (2395.825MHz-2487.645MHz) is exempt from the essential performance requirements, but remains safe.

a Field strengths from fixed transmitters, such as base stations for radio (cellular/cordless) telephones and land mobile radios, amateur radio, AM and FM radio broadcast and TV broadcast cannot be predicted theoretically with accuracy. To assess the electromagnetic environment due to fixed RF transmitters, an electromagnetic site survey should be considered. If the measured field strength in the location in which the [ME EQUIPMENT or ME SYSTEM] is used exceeds the applicable RF compliance level above, the [ME EQUIPMENT or ME SYSTEM] should be observed to verify normal operation. If abnormal

performance is observed, additional measures may be necessary, such as re-orienting or relocating the [ME EQUIPMENT or ME SYSTEM].

b Over the frequency range 150 kHz to 80 MHz, field strengths should be less than 3V/m. For BIS and ICG, field strengths should be less than 1V/m.



WARNING

- **The device is configured with a wireless network connector to receive wireless signal. Other devices may interfere with this device even though they meet the requirements of CISPR.**

Recommended separation distances between portable and mobile RF communications equipment and the device

The device is intended for use in an electromagnetic environment in which radiated RF disturbances are controlled. The customer or the user of the device can help prevent electromagnetic interference by maintaining a minimum distance between portable and mobile RF communications equipment (transmitters) and the device as recommended below, according to the maximum output power of the communications equipment.

Rated maximum output power of transmitter (W)	Separation distance in meters (m) according to frequency of the transmitter		
	150 kHz to 80 MHz $d = 1.2\sqrt{P}$ (BIS, ICG: $d = 3.5\sqrt{P}$)	80 MHz to 800 MHz $d = 1.2\sqrt{P}$ (Resp: $d = 3.5\sqrt{P}$)	800 MHz to 2.5 GHz $d = 2.3\sqrt{P}$ (Resp: $d = 7\sqrt{P}$)
0.01	0.12 (BIS, ICG: 0.35)	0.12 (0.35)	0.23 (0.70)
0.1	0.38 (BIS, ICG: 1.11)	0.38 (1.11)	0.73 (2.22)
1	1.20 (BIS, ICG: 3.50)	1.20 (3.50)	2.30 (7.00)
10	3.80 (BIS, ICG: 11.07)	3.80 (11.07)	7.30 (22.14)
100	12.00 (BIS, ICG: 35.00)	12.00 (35.00)	23.00 (70.00)

For transmitters rated at a maximum output power not listed above, the recommended separation distance d in metres (m) can be estimated using the equation applicable to the frequency of the transmitter, where P is the maximum output power rating of the transmitter in watts (W) according to the transmitter manufacturer.

Note 1: At 80 MHz and 800 MHz, the separation distance for the higher frequency range applies.

Note 2: These guidelines may not apply in all situations. Electromagnetic propagation is affected by absorption and reflection from structures, objects and people.

B.2 Radio Regulatory Compliance

RF parameters (for Passport 12m)

Type of Radio	IEEE 802.11b/g/n (2.4G)	IEEE 802.11a/n (5G)
Modulation mode	DSSS and OFDM	OFDM
Operating frequency	2400-2483.5MHz	5150-5350 MHz 5470-5725 MHz 5725-5850 MHz
Channel spacing	5 MHz	20 MHz
Output power	< 30 dBm (Peak Power) < 20 dBm (Average Power)	

Federal Communications Commission (FCC) Statement

The wireless module has been tested and found to comply with the limits for a class B digital device, pursuant to Part 15 of the FCC rules. These limits are designed to provide reasonable protection against harmful interference in a residential installation. This equipment generates, uses and can radiate radio frequency energy and, if not installed and used in accordance with the instructions, may cause harmful interference to radio communications. However, there is no guarantee that interference will not occur in a particular installation. If this equipment does cause harmful interference to radio or television reception, which can be determined by turning the equipment off and on, the user is encouraged to try to correct the interference by one or more of the following measures:

- Reorient or relocate the receiving antenna.
- Increase the separation between the equipment and receiver.
- Connect the equipment into an outlet on a circuit different from that to which the receiver is connected.
- Consult the dealer or an experienced radio/TV technician for help.



CAUTION

- **Changes or modifications not expressly approved by the party responsible for compliance could void the user's authority to operate the equipment.**
-



The radio device used in this product is in compliance with the essential requirements and other relevant provisions of Directive 1999/5/EC (Radio Equipment and Telecommunications Terminal Equipment Directive).



WARNING

- **This compliance to general radiation exposure limits for an uncontrolled environment, and minimum of 20 cm separation between monitor and human body.**
-

FOR YOUR NOTES

C Default Configurations

This chapter lists some of the most important factory default settings in configuration management. You cannot change the factory default configuration itself. However, you can make changes to the settings from the factory default configuration and then save the changed configuration as a user configuration.

C.1 Parameters Configuration

C.1.1 ECG

ECG Setup

Item Name	Configurable		Default
	In Config Mode	In Monitor Mode	
Alm Source	Yes	Yes	HR
Alarm	Yes	Yes	On
Alm Lev	Yes	Yes	Med
HR/PR High	Yes	Yes	Adu: 120
			Ped: 160
			Neo: 200
HR/PR Low	Yes	Yes	Adu: 50
			Ped: 75
			Neo: 100
Gain	Yes	Yes	X1
Sweep	Yes	Yes	25 mm/s
Filter	Yes	Yes	General: Monitor OR: Surgery ICU, NICU: Monitor CCU: Diagnostic
QRS Volume	Yes	Yes	General, OR: 2 ICU, NICU, CCU: 1
QRS threshold	No	Yes	0.16 mV
Lead Set	Yes	Yes	Auto (if auto lead detection is available); 5-lead (if auto lead detection is not available)
ECG Display	Yes	Yes	Normal
Notch Filter	Yes	Yes	Weak
Paced	No	Yes	No
Pacer Reject	No	Yes	Off
Smart Lead Off	Yes	Yes	On
Baseline Drift Removal (12-lead screen only)	Yes	Yes	On

Item Name	Configurable		Default
	In Config Mode	In Monitor Mode	
Waveform Layout (12-lead screen only)	Yes	Yes	Standard
ECG Waveform Area (12-lead screen only)	No	Yes	Normal

ST Analysis

Item Name	Configurable		Default
	In Config Mode	In Monitor Mode	
ST Analysis	Yes	Yes	General, OR, ICU, NICU: Off CCU: On
ST Display	Yes	Yes	All
Alarm	Yes	Yes	Off
Alm Lev	Yes	Yes	Med
ST-X High	Yes	Yes	When ST Unit is mV: 0.20 When ST Unit is mm: 2.0
ST-X Low	Yes	Yes	When ST Unit is mV: -0.20 When ST Unit is mm: -2.0
Auto	Yes	Yes	Off
ISO	Yes	Yes	-80 ms
J	Yes	Yes	48 ms
ST	Yes	Yes	J + 60 ms

X represents I, II, III, aVR, aVL, aVF, V, V1, V2, V3, V4, V5 or V6.

QT/QTc Analysis

Item Name	Configurable		Default
	In Config Mode	In Monitor Mode	
QT Analysis	Yes	Yes	Off
QTc Formula	Yes	Yes	Hodges
Analysis lead	Yes	Yes	All
QTc Alarm	Yes	Yes	Off
Δ QTc Alarm	Yes	Yes	Off
QTc Alarm Level	Yes	Yes	Med
Δ QTc Alarm Level	Yes	Yes	Med
QTc Record	Yes	Yes	Off
Δ QTc Record	Yes	Yes	Off

Arrh. Analysis

Arrhythmia Threshold Settings (Mindray)				
Item Name	Configurable		Default	
	In Config Mode	In Monitor Mode		
PVCs High	Yes	Yes	10	
Asys. Delay	Yes	Yes	5	
Vtac Rate	Yes	Yes	130	
Vtac PVC	Yes	Yes	6	
Multif. PVC's Window	Yes	Yes	15	
Tachy	Yes	Yes	Adu: 120 Ped: 160	
Brady	Yes	Yes	Adu: 50 Ped: 75	
Extreme Tachy	Yes	Yes	Adu: 160 Ped: 180	
Extreme Brady	Yes	Yes	Adu: 35 Ped: 50	
Vbrd Rate	Yes	Yes	40	
Vbrd PVCs	Yes	Yes	5	
Pause Time	Yes	Yes	2	
Arrhythmia Alarm Settings (Mindray)				
Item Name	Configurable		Default	
	In Config Mode	In Monitor Mode	Alarm Switch	Alarm Level
Asystole Alarm	Yes	Yes	On	High
VFib/VTac Alarm	Yes	Yes	On	High
Vtac Alarm	Yes	Yes	On	High
Vent. Brady Alarm	Yes	Yes	On	High
Extreme Tachy Alarm	Yes	Yes	On	High
Extreme Brady Alarm	Yes	Yes	On	High
PVCs/min Alarm	Yes	Yes	General, OR, ICU, NICU: Off CCU: On	Med
R on T Alarm	Yes	Yes	General, OR, ICU, NICU: Off CCU: On	Med
Run PVCs Alarm	Yes	Yes	Off	Low
Couplet Alarm	Yes	Yes	Off	Message
Multif. PVC Alarm	Yes	Yes	Off	Med
PVC Alarm	Yes	Yes	Off	Message
Bigeminy Alarm	Yes	Yes	General, OR, ICU, NICU: Off CCU: On	Med
Trigeminy Alarm	Yes	Yes	General, OR, ICU, NICU: Off	Med

Arrhythmia Threshold Settings (Mindray)				
Item Name	Configurable		Default	
			CCU: On	
Tachy Alarm	Yes	Yes	Off	Med
Brady Alarm	Yes	Yes	Off	Med
Pacer Not Pacing Alarm	Yes	Yes	Off	Message
Pacer Not Capture Alarm	Yes	Yes	Off	Message
Missed Beats Alarm	Yes	Yes	Off	Message
Nonsus. Vtac Alarm	Yes	Yes	General, OR, ICU, NICU: Off CCU: On	Med
Vent. Rhythm Alarm	Yes	Yes	Off	Med
Pause Alarm	Yes	Yes	Off	Low
Irr. Rhythm Alarm	Yes	Yes	Off	Message
Afib Alarm	Yes	Yes	Off	Message

C.1.2 RESP

Item Name	Configurable		Default
	In Config Mode	In Monitor Mode	
Alarm	Yes	Yes	On
Alm Lev	Yes	Yes	Med
RR High	Yes	Yes	Adu, Ped: 30 Neo: 100
RR Low	Yes	Yes	Adu, Ped: 8 Neo: 30
Apnea Delay	Yes	Yes	Adu, Ped: 20 Neo: 15
Lead	Yes	Yes	Adu, Ped: Auto Neo: II
Gain	Yes	Yes	X2
Sweep	Yes	Yes	6.25 mm/s
Detection Mode	Yes	Yes	Auto
RR Source	No	Yes	Auto

C.1.3 PR

Item Name	Configurable		Default
	In Config Mode	In Monitor Mode	
Alarm	Yes	Yes	On
Alm Lev	Yes	Yes	Med
HR/PR High	Yes	Yes	Adu: 120
			Ped: 160
			Neo: 200
HR/PR Low	Yes	Yes	Adu: 50
			Ped: 75
			Neo: 100
PR Source	Yes	Yes	SpO ₂
Alm Source	Yes	Yes	HR
Beat Vol	Yes	Yes	General, OR: 2 ICU, NICU, CCU: 1

C.1.4 SpO₂

Item Name	Configurable		Default
	In Config Mode	In Monitor Mode	
Alarm	Yes	Yes	On
Alm Lev	Yes	Yes	SpO ₂ : Med Desat: High
SpO ₂ High	Yes	Yes	Adu, Ped: 100 Neo: 95
SpO ₂ Low	Yes	Yes	90
Desat	Yes	Yes	80
Sensitivity (Mindray)	Yes	Yes	Med
Sensitivity (Masimo)	Yes	Yes	Normal
Averaging (Masimo)	Yes	Yes	8 s
Sat-Seconds (Nellcor)	Yes	Yes	0 s
PI Zoom	Yes	Yes	No
Sweep	Yes	Yes	25 mm/s
NIBP Simul	No	Yes	Off

C.1.5 ΔSpO₂

Item Name	Configurable		Default
	In Config Mode	In Monitor Mode	
Alarm	Yes	Yes	Off
Alm Lev	Yes	Yes	Med
ΔSpO ₂ High	Yes	Yes	10 %
PI Zoom	Yes	Yes	No

C.1.6 Temp

Item Name	Configurable		Default
	In Config Mode	In Monitor Mode	
Alarm	Yes	Yes	On
Alm Lev	Yes	Yes	Med
T1/T2 High (°C)	Yes	Yes	38.0
T1/T2 Low (°C)	Yes	Yes	35.0
TD High (°C)	Yes	Yes	2.0

C.1.7 NIBP

Item Name	Configurable		Default
	In Config Mode	In Monitor Mode	
Alarm	Yes	Yes	On
Alm Lev	Yes	Yes	Med
Interval	Yes	Yes	General: 15 min OR: 5 min ICU: 15 min NICU: 30 min CCU: 15 min
NIBP End Tone	Yes	Yes	Off
Clock	Yes	Yes	On
Initial Pressure (mmHg)	Yes	Yes	Adu: 160 Ped: 140 Neo: 90
Cuff Press. (mmHg)	Yes	Yes	Adu: 80 Ped: 60 Neo: 40
Alarm Limit			
NIBP-S High (mmHg)	Yes	Yes	Adu: 160 Ped: 120 Neo: 90
NIBP-S Low (mmHg)	Yes	Yes	Adu: 90 Ped: 70 Neo: 40
NIBP-M High (mmHg)	Yes	Yes	Adu: 110 Ped: 90 Neo: 70

Item Name	Configurable		Default
	In Config Mode	In Monitor Mode	
NIBP-M Low (mmHg)	Yes	Yes	Adu: 60 Ped: 50 Neo: 25
NIBP-D High (mmHg)	Yes	Yes	Adu: 90 Ped: 70 Neo: 60
NIBP-D Low (mmHg)	Yes	Yes	Adu: 50 Ped: 40 Neo: 20

C.1.8 IBP

Item Name	Configurable		Default
	In Config Mode	In Monitor Mode	
Alarm	Yes	Yes	On
Alm Lev	Yes	Yes	Med
P1 Measure	Yes	Yes	All
P2 Measure	Yes	Yes	All
P3 Measure	Yes	Yes	Mean
P4 Measure	Yes	Yes	Mean
PPV Measurement	Yes	Yes	Off
PPV Source	Yes	Yes	Auto
Sensitivity	Yes	Yes	Med
Sweep	Yes	Yes	25 mm/s
Filter	Yes	Yes	12.5 Hz
Gridlines	Yes	Yes	Off
Art, Ao, UAP, BAP, FAP, LV, P1-P2 Arterial Pressure Alarm Limits			
IBP-S High (mmHg)	Yes	Yes	Adu: 160 Ped: 120 Neo: 90
IBP-S Low (mmHg)	Yes	Yes	Adu: 90 Ped: 70 Neo: 55
IBP-M High (mmHg)	Yes	Yes	Adu: 110 Ped: 90 Neo: 70
IBP-M Low (mmHg)	Yes	Yes	Adu: 70 Ped: 50 Neo: 35

Item Name	Configurable		Default
	In Config Mode	In Monitor Mode	
IBP-D High (mmHg)	Yes	Yes	Adu: 90 Ped: 70 Neo: 60
IBP-D Low (mmHg)	Yes	Yes	Adu: 50 Ped: 40 Neo: 20

PA Alarm Limit			
PA-S High (mmHg)	Yes	Yes	Adu: 35 Ped, Neo: 60
PA-S Low (mmHg)	Yes	Yes	Adu: 10 Ped, Neo: 24
PA-M High (mmHg)	Yes	Yes	Adu: 20 Ped, Neo: 26
PA-M Low (mmHg)	Yes	Yes	Adu: 0 Ped, Neo: 12
PA-D High (mmHg)	Yes	Yes	Adu: 16 Ped, Neo: 4
PA-D Low (mmHg)	Yes	Yes	Adu: 0 Ped, Neo: -4
CVP, LAP, RAP, ICP, UVP, P3-P4 Venous Pressure Alarm Limits			
IBP-M High (mmHg)	Yes	Yes	Adu: 10 Ped, Neo: 4
IBP-M Low (mmHg)	Yes	Yes	0
Art, Ao, BAP, FAP, LV, P1-P2 Arterial Pressure Scale			
Scale (mmHg)	Yes	Yes	0-160
PA Waveform Scale			
Scale (mmHg)	Yes	Yes	0-30
CVP, LAP, RAP, ICP, UVP Scale			
Scale (mmHg)	Yes	Yes	0-20
UAP, P3-P4 Venous Pressure Scale			
Scale (mmHg)	Yes	Yes	0-80
IBP Overlapping Left Scale			
Scale (mmHg)	Yes	Yes	0-160
IBP Overlapping Right Scale			
Scale (mmHg)	Yes	Yes	0-20

C.1.9 C.O.

Item Name	Configurable		Default
	In Config Mode	In Monitor Mode	
Alarm	Yes	Yes	On
Alm Lev	Yes	Yes	Med
TB High (°C)	Yes	Yes	39.0
TB Low (°C)	Yes	Yes	36.0
Comp. Const	Yes	Yes	0.542
Auto TI	Yes	Yes	Auto
Manual TI (°C)	Yes	Yes	2.0
Measuring mode	Yes	Yes	Manual

C.1.10 CCO/SvO₂ Setup (Vigilance II)

Item Name	Configurable		Default
	In Config Mode	In Monitor Mode	
Alarm	Yes	Yes	Off
Alarm Level	Yes	Yes	Med
Primary Parameter	Yes	Yes	C.O./CCO
Secondary Parameters	Yes	Yes	SVR, EDV, SV
CCO High	Yes	Yes	14
CCO Low	Yes	Yes	2
CCI High	Yes	Yes	10
CCI Low	Yes	Yes	1
EDV High	Yes	Yes	300
EDV Low	Yes	Yes	80
EDVI High	Yes	Yes	150
EDVI Low	Yes	Yes	60
SVR High	Yes	Yes	1500 DS/cm ⁵
SVR Low	Yes	Yes	500 DS/cm ⁵
SVRI High	Yes	Yes	3000 DS·m ² / cm ⁵
SVRI Low	Yes	Yes	1000 DS·m ² / cm ⁵
RVEF High	Yes	Yes	50
RVEF Low	Yes	Yes	0
SV High	Yes	Yes	120
SV Low	Yes	Yes	20
SVI High	Yes	Yes	60
SVI Low	Yes	Yes	10
SvO ₂ High	Yes	Yes	90
SvO ₂ Low	Yes	Yes	40
ScvO ₂ High	Yes	Yes	90
ScvO ₂ Low	Yes	Yes	40

C.1.11 CCO/SvO₂ Setup (Vigileo)

Item Name	Configurable		Default
	In Config Mode	In Monitor Mode	
Alarm	Yes	Yes	Off
Alarm Level	Yes	Yes	Med
Primary Parameter	Yes	Yes	CCO
Secondary Parameters	Yes	Yes	SV, SVR, SVV
CCO High	Yes	Yes	14
CCO Low	Yes	Yes	2
CCI High	Yes	Yes	10
CCI Low	Yes	Yes	1
SV High	Yes	Yes	120
SV Low	Yes	Yes	20
SVI High	Yes	Yes	60
SVI Low	Yes	Yes	10
SVV High	Yes	Yes	30
SVV Low	Yes	Yes	0
SVR High	Yes	Yes	1500 DS/cm ⁵
SVR Low	Yes	Yes	500 DS/cm ⁵
SVRI High	Yes	Yes	3000 DS·m ² / cm ⁵
SVRI Low	Yes	Yes	1000 DS·m ² / cm ⁵
SvO ₂ High	Yes	Yes	90
SvO ₂ Low	Yes	Yes	40
ScvO ₂ High	Yes	Yes	90
ScvO ₂ Low	Yes	Yes	40

C.1.12 CCO/SvO₂ Setup (EV1000)

Item Name	Configurable		Default
	In Config Mode	In Monitor Mode	
Alarm	Yes	Yes	Off
Alarm Level	Yes	Yes	Med
Parameter Display (when the EV1000 is in the None or VolumeView mode)	Yes	Yes	Indexed
Secondary Parameters (when the EV1000 is in the None or VolumeView mode)	Yes	Yes	GEDI, SVRI, ELWI
Parameter Display (when the EV1000 is in the FloTrac or ClearSightmode)	Yes	Yes	Indexed
Secondary Parameters (when the EV1000 is in the FloTrac or ClearSightmode)	Yes	Yes	SVI, SVV, SVRI
CCO High	Yes	Yes	14
CCO Low	Yes	Yes	2
CCI High	Yes	Yes	10
CCI Low	Yes	Yes	1
SV High	Yes	Yes	120
SV Low	Yes	Yes	20
SVI High	Yes	Yes	60
SVI Low	Yes	Yes	10
SVV High	Yes	Yes	30
SVV Low	Yes	Yes	0
SVR High	Yes	Yes	1500 DS/cm ⁵
SVR Low	Yes	Yes	500 DS/cm ⁵
SVRI High	Yes	Yes	3000 DS·m ² / cm ⁵
SVRI Low	Yes	Yes	1000 DS·m ² / cm ⁵
SvO ₂ High	Yes	Yes	90
SvO ₂ Low	Yes	Yes	40
ScvO ₂ High	Yes	Yes	90
ScvO ₂ Low	Yes	Yes	40

C.1.13 CO₂

Item Name	Configurable		Default
	In Config Mode	In Monitor Mode	
Alarm	Yes	Yes	On
Alm Lev	Yes	Yes	Med
Apnea Delay	Yes	Yes	Adu, Ped: 20 Neo: 15
Operating Mode	Yes	Yes	Measure
Sweep	Yes	Yes	6.25 mm/s
Scale (mmHg)	Yes	Yes	50
RR Source	No	Yes	Auto
Sidestream CO₂ Setup			
Flow Rate	Yes	Yes	Adu, 120 ml/min Ped: 100 ml/min Neo: 70 ml/min
BTPS Compen	Yes	Yes	Off
N ₂ O Compen	Yes	Yes	0
O ₂ Compen	Yes	Yes	General: 21 OR: 100 ICU, NICU, CCU: 21
Des Compen	Yes	Yes	0
Microstream CO₂ Setup			
BTPS Compen	Yes	Yes	Off
Max Hold	Yes	Yes	20 s
Auto Standby (min)	Yes	Yes	0
Alarm Limits			
EtCO ₂ High (mmHg)	Yes	Yes	Adu, Ped: 50 Neo: 45
EtCO ₂ Low (mmHg)	Yes	Yes	Adu, Ped: 25 Neo: 30
FiCO ₂ High (mmHg)	Yes	Yes	Adu, Ped, Neo: 4
RR High	Yes	Yes	Adu, Ped: 30 Neo: 100
RR Low	Yes	Yes	Adu, Ped: 8 Neo: 30

C.1.14 tcGas

Item Name	Configurable		Default
	In Config Mode	In Monitor Mode	
Alarm Sound	Yes	Yes	Off
Change Secondary Parameters	Yes	Yes	SpO ₂ , PR, Power

C.1.15 AG

Item Name	Configurable		Default
	In Config Mode	In Monitor Mode	
Alarm	Yes	Yes	On
Alm Lev	Yes	Yes	Med
Sweep	Yes	Yes	6.25 mm/s
O ₂ Compen	Yes	Yes	OR: On General, ICU, NICU, CCU: Off
Operating Mode	Yes	Yes	Measure
Flow Rate	Yes	Yes	Adu, Ped: 120 ml/min Neo: 70 ml/min
Auto Standby	Yes	Yes	Off
Apnea Time	Yes	Yes	20 s
RR Source	No	Yes	Auto
CO₂ Setup			
Wave Type	Yes	Yes	Draw
Scale	Yes	Yes	When unit is mmHg: 50 When unit is % or KPa: 7.0
EtCO ₂ High (mmHg)	Yes	Yes	Adu, Ped: 50 Neo: 45
EtCO ₂ Low (mmHg)	Yes	Yes	Adu, Ped: 25 Neo: 30
FiCO ₂ High (mmHg)	Yes	Yes	4
RR High	Yes	Yes	Adu, Ped: 30 Neo: 100
RR Low	Yes	Yes	Adu, Ped: 8 Neo: 30
Gas Setup			
Agent	Yes	Yes	AA
N ₂ O Scale	Yes	Yes	50
O ₂ Scale	Yes	Yes	When unit is mmHg: 400 When unit is % or KPa: 50
AA Scale	Yes	Yes	9.0
Hal/Enf/Iso Scale	Yes	Yes	2.5
Des Scale	Yes	Yes	9.0
Sev Scale	Yes	Yes	4.0
EtO ₂ High	Yes	Yes	88
EtO ₂ Low	Yes	Yes	18
FiO ₂ High	Yes	Yes	Adu, Ped: 100 Neo: 90
FiO ₂ Low	Yes	Yes	18
EtN ₂ O High	Yes	Yes	55
EtN ₂ O Low	Yes	Yes	0
FiN ₂ O High	Yes	Yes	53

Item Name	Configurable		Default
	In Config Mode	In Monitor Mode	
FiN ₂ O Low	Yes	Yes	0
EtHal/Enf/Iso High	Yes	Yes	3.0
EtHal/Enf/Iso Low	Yes	Yes	0.0
FiHal/Enf/Iso High	Yes	Yes	2.0
FiHal/Enf/Iso Low	Yes	Yes	0.0
EtSev High	Yes	Yes	6.0
EtSev Low	Yes	Yes	0.0
FiSev High	Yes	Yes	5.0
FiSev Low	Yes	Yes	0.0
EtDes High	Yes	Yes	8.0
EtDes Low	Yes	Yes	0.0
FiDes High	Yes	Yes	6.0
FiDes Low	Yes	Yes	0.0

C.1.16 BIS

Item Name	Configurable		Default
	In Config Mode	In Monitor Mode	
Alarm	Yes	Yes	On
Alm Lev	Yes	Yes	Med
Smoothing Rate	Yes	Yes	General, OR, ICU,CCU: 15 s
			NICU: Adu: 15s Ped: 15s Neo: N/A
Display	Yes	Yes	General, OR, ICU,CCU: EEG
			NICU: Adu: EEG Ped: EEG Neo: N/A
Filters	Yes	Yes	General, OR, ICU,CCU: On
			NICU: Adu: On Ped: On Neo: N/A
Scale	Yes	Yes	General, OR, ICU,CCU: 100 μ V
			NICU: Adu: 100 μ V Ped: 100 μ V Neo: N/A
Sweep	Yes	Yes	General, OR, ICU,CCU: 25mm/s
			NICU: Adu: 25mm/s Ped: 25mm/s Neo: N/A
Trend Length	Yes	Yes	General, OR, ICU,CCU: 60 min

Item Name	Configurable		Default
	In Config Mode	In Monitor Mode	
			Adu: 60 min NICU: Ped: 60 min Neo: N/A
Secondary Parameters	Yes	Yes	General, OR, ICU,CCU: SR,SEF
			NICU: Adu, Ped: SR, SEF Neo: N/A
Display	Yes	Yes	General, OR, ICU,CCU: BIS Trend
			NICU: Adu: BIS Trend Ped: BIS Trend Neo: N/A
EEG Waveforms	Yes	Yes	General, OR, ICU,CCU: All
			NICU: Adu: All Ped: All Neo: N/A
Parameter 1	Yes	Yes	General, OR, ICU,CCU: BIS L
			NICU: Adu: BIS L Ped: BIS L Neo: N/A
Parameter 2	Yes	Yes	General, OR, ICU,CCU: EMG
			NICU: Adu: EMG Ped: EMG Neo: N/A
BIS High	Yes	Yes	70
BIS Low	Yes	Yes	70

C.1.17 NMT

NMT from Mindray NMT module

Item Name	Configurable		Default
	In Config Mode	In Monitor Mode	
Stimulation mode	Yes	Yes	TOF
Interval	Yes	Yes	TOF, DBS: 1 min
			ST: 0.1 Hz
Stimulation Current	Yes	Yes	Supra
Pulse Width	Yes	Yes	200 μ s
Stimulation Beep Volume	Yes	Yes	2
Block Recovery	Yes	Yes	Off
DBS	Yes	Yes	DBS 3.3
NMT parameter switch	No	Yes	On

NMT from TOF-Watch® SX monitor

Item Name	Configurable		Default
	In Config Mode	In Monitor Mode	
Alarm Sound	Yes	Yes	Off

C.1.18 RM

Item Name	Configurable		Default
	In Config Mode	In Monitor Mode	
Alarm	Yes	Yes	On
Alm Lev	Yes	Yes	Med
Apnea Delay	Yes	Yes	Adu, Ped: 20S Neo: 15 s
Sensor Type	No	Yes	Disposable
TV/MV	Yes	Yes	TV
Flow/Vol	Yes	Yes	Flow
Sweep	Yes	Yes	6.25 mm/s
RR Source	No	Yes	Auto
Paw Scale	Yes	Yes	Adu, Ped: 40 Neo: N/A
Flow Scale	Yes	Yes	Adu, Ped: 60 Neo: N/A
Vol Scale	Yes	Yes	Adu, Ped: 1200 Neo: N/A
Display Loop	No	Yes	PV Loop
Reference Loop	No	Yes	On
RR High	Yes	Yes	Adu, Ped: 30 Neo: 100
RR Low	Yes	Yes	Adu, Ped: 8 Neo: 30
PEEP High	Yes	Yes	10
PEEP Low	Yes	Yes	0
PIP High	Yes	Yes	40
PIP Low	Yes	Yes	1
MVe High	Yes	Yes	30.0
MVe Low	Yes	Yes	2.0

C.2 Routine Configuration

C.2.1 Alarm

Item Name	Configurable		Default
	In Config Mode	In Monitor Mode	
Alm Volume	Yes	Yes	General: 2 OR: 1 ICU, NICU, CCU: 2
Reminder Vol	Yes	Yes	Low
Recording Length	Yes	Yes	16 s
Apnea Delay	Yes	Yes	Adu, Ped: 20s Neo: 15 s
Alarm Delay	Yes	Yes	6 s
ST Alarm Delay	Yes	Yes	30 s
VTac Latching	No	Yes	On

C.2.2 Screens

Item Name	Configurable		Default	
	In Config Mode	In Monitor Mode		
Choose Screen	Yes	Yes	Normal Screen	
Display the ST segments on ECG screen	Yes	Yes	Unselected	
Select Wave Sequence for Normal Screen	1	Yes	Yes	ECG1
	2			ECG2
	3			SpO ₂ +PR
	4			Any IBP
	5			Any IBP
	6			CO ₂
	7			Paw
	8			Flow/Vol
	9			BIS
	10			Resp
Select Parameters for Big Numerics Screen	Parameter 1	Yes	Yes	ECG
	Parameter 2			SpO ₂ +PR
	Parameter 3			Resp
	Parameter 4			NIBP

Item Name		Select QuickKeys (Passport 12m)
O.M	C	Yes
	M	No
General		NIBP Measure→Stop All→Zero IBP→Review→Standby→Screens→Patient Setup→Manual Event→Realtime Print→Volume Setup
OR		
ICU		
NICU		NIBP Measure→Stop All→oxyCRG→Review→Standby→Screens→Patient Setup→Manual Event→Realtime Print→Volume Setup
CCU		NIBP Measure→Stop All→Zero IBP→Review→Standby→Screens→Patient Setup→Manual Event→Realtime Print→Volume Setup
User Defaults		

Item Name		Select QuickKeys (Passport 17m)
O.M	C	Yes
	M	No
General		NIBP Measure→Stop All→Zero IBP→Screens→Patient Setup→Manual Event→Realtime Print→Print Setup→Minitrends→Volume Setup→Load Configuration→Privacy Mode
OR		NIBP Measure→Stop All→Zero IBP→Screens→Patient Setup→Manual Event→Realtime Print→Print Setup→Minitrends→Volume Setup→Load Configuration→PAWP
ICU		NIBP Measure→Stop All→Zero IBP→Screens→Patient Setup→Manual Event→Realtime Print→Print Setup→Minitrends→Volume Setup→Load Configuration→Privacy Mode
NICU		NIBP Measure→Stop All→oxyCRG→Screens→Patient Setup→Manual Event→Realtime Print→Minitrends→Zero IBP→Volume Setup→Load Configuration→Privacy Mode
CCU		NIBP Measure→Stop All→Zero IBP→Screens→Patient Setup→Manual Event→Realtime Print→Print Setup→Minitrends→Volume Setup→Load Configuration→Privacy Mode
User Defaults		

C.2.3 Parameter/Wave Color

Item Name	Configurable		Default
	In Config Mode	In Monitor Mode	
ECG	No	Yes	Green
NIBP			White
SpO ₂			Cyan
SpO ₂ b			Purple
Δ SpO ₂			Yellow
PR			Cyan
TEMP			White
Art/Ao/UAP/FAP /BAP/LV/P1~P4 (arterial pressure)			Red
PA			Yellow
CVP/ICP/P1~P4 (venous pressure)			Blue
LAP			Purple
RAP			Orange
UVP			Cyan
CO ₂ /tcpCO ₂			Yellow
RESP			Yellow
AA			Yellow
N ₂ O			Blue
O ₂ /tcpO ₂			Green
Hal			Red
Enf			Orange
Iso			Purple
Des			Cyan
Sev			Yellow
C.O.			White
Paw			Blue
Flow/Vol			Blue
NMT			White
EEG L/BIS L Trend			Yellow
EEG R/BIS R Trend			Blue
SvO ₂			Cyan
ScvO ₂			Purple
CCO			Yellow

C.2.4 Review

Item Name		Configurable		Default
		In Config Mode	In Monitor Mode	
Tabular Trends	Interval	No	Yes	General: 30 min OR: 5 min ICU, NICU, CCU: 30 min
	Trend Group	No	Yes	Standard
Graphic Trends	Trend Group	No	Yes	Standard
	Zoom	No	Yes	90 min
	Waves	No	Yes	2
Full Disclosure	Save Waves	No	Yes	Save ECG1 by default.
	Gain	No	Yes	x 1
	Sweep	No	Yes	25 mm/s

C.2.5 Event

Item Name		Configurable		Default
		In Config Mode	In Monitor Mode	
Waveform 1		No	Yes	II
Waveform 2		No	Yes	General, OR, ICU, CCU: I NICU Pleth
Waveform 3		No	Yes	General, OR, ICU, CCU: Pleth NICU Resp

C.2.6 Record

Item Name		Configurable		Default
		In Config Mode	In Monitor Mode	
Length		No	Yes	8 s
Interval		No	Yes	Off
Paper Speed		No	Yes	25 mm/s
IBP Overlap		No	Yes	Off
Alm Rec	X	No	Yes	Off

X represents a parameter label.

C.2.7 Print

Item Name	Configurable		Default	
	In Config Mode	In Monitor Mode		
Paper Size	No	Yes	Letter	
Print On Both Sides	No	Yes	Off	
ECG Reports	Amplitude	No	Yes	10 mm/mV
	Sweep	No	Yes	25 mm/s
	Auto Interval	No	Yes	Off
	12-Lead Format	No	Yes	12 x 1
Tabular Trends Reports	Set as End Case Report	No	Yes	Unselected
	Back	No	Yes	Auto
	Resolution	No	Yes	Auto
	Report Format	No	Yes	Parameter Oriented
	Currently Displayed Trended Parameters	No	Yes	Selected
	Standard Parameter Group	No	Yes	Unselected
	Custom	No	Yes	Unselected
Graphic Trends Reports	Not Print Blank Pages	No	Yes	Selected
	Set as End Case Report	No	Yes	Unselected
	Back	No	Yes	Auto
	Paginal Time	No	Yes	Auto
Realtime Reports	Set as End Case Report	No	Yes	Unselected
	Sweep	No	Yes	Auto
	Select Wave	No	Yes	Current

C.2.8 Night Mode

Item Name	Configurable		Default
	In Config Mode	In Monitor Mode	
Brightness	Yes	Yes	1
Alm Volume	Yes	Yes	2
QRS Volume	Yes	Yes	1
Key Volume	Yes	Yes	0
NIBP End Tone	Yes	Yes	Off

C.2.9 Others

Item Name	Configurable		Default
	In Config Mode	In Monitor Mode	
Brightness	No	Yes	5
Key Volume	No	Yes	2

C.3 User Maintenance Items

Item Name	Configurable		Default
	In Config Mode	In Monitor Mode	
Changing Pat. Loc.	No	Yes	Protected
Network Encrypt Switch	No	Yes	Off
Barometric Pressure	No	Yes	760 mmHg
Height Unit	No	Yes	cm
Weight Unit	No	Yes	kg
ST Unit	No	Yes	mV
Press. Unit	No	Yes	mmHg
Hb Unit	No	Yes	g/dl
CVP Unit	No	Yes	cmH ₂ O
CO ₂ Unit	No	Yes	mmHg
O ₂ Unit	No	Yes	%
Temp Unit	No	Yes	°C
tcpCO ₂ / tcpO ₂ Unit	No	Yes	mmHg
Network Type	No	Yes	LAN
Address Type	No	Yes	Manual
Select CMS	No	Yes	Off
ADT Query	No	Yes	On
Latching Alarms	No	Yes	Lethal
Alarm Pause Time	No	Yes	2 min
Minimum Alarm Volume	No	Yes	General, ICU, NICU, CCU: 2 OR: 1
Alarm Sound	No	Yes	ISO
High Alarm Interval (ISO mode)	No	Yes	10
Medium (ISO mode)	No	Yes	20
Low Alarm Interval (ISO mode)	No	Yes	20
Reset Other Bed's Alarms	No	Yes	Off
Alarm Reset By Other Bed	No	Yes	On
Other Bed Disconnection Alarm	No	Yes	On
Reminder Interval	No	Yes	3 min
Reminder Tone	No	Yes	On
ECGLeadOff Lev.	No	Yes	Low
SpO ₂ SensorOff Lev.	No	Yes	Low
IBPSensorOff Lev.	No	Yes	Med
Lethal Arrh. OFF	No	Yes	Disable
Extended Arrh.	No	Yes	Enable
Alarm Light on Alarm Reset	No	Yes	On
Alarm Delay	No	Yes	6 s
ST Alarm Delay	No	Yes	30 s
Vtac Latching Lock	Yes	Yes	Enable
Wave Line	No	Yes	Med

Item Name	Configurable		Default	
	In Config Mode	In Monitor Mode		
Primary Button	No	Yes	Left	
ECG Standard	No	Yes	AHA	
Notch Freq.	No	Yes	50 Hz	
Data Transfer Method	No	Yes	Off	
Transferred Data Length	No	Yes	4 h	
Apply Module Settings	No	Yes	Off	
Parameter Switch	Yes	Yes	Selected	
SpO ₂ Tone	No	Yes	Mode 1	
Clear CMS IP at startup	Yes	Yes	Off	
Nurse Call Setup	Signal Type	No	Yes	Continuous
	Contact Type	No	Yes	Normally Closed
	Alm Lev	Yes	Yes	High, Med, Low
	Alarm Cat.	Yes	Yes	Phys., Tech.

FOR YOUR NOTES

D Alarm Messages

This chapter lists only the most important physiological and technical alarm messages. Some messages appearing on your monitor may not be included.

In this chapter:

- The “I” column indicates how indications of technical alarms perform after the alarm system is reset: “A” means that some technical alarms are cleared; “B” indicates that some technical alarms are changed to the prompt messages; and “C” indicates that a “√” appears before the alarm message,  appears in the alarm symbol area, and the indication of the alarm lamp depends on the alarm light setting. Refer to section **7.8 Resetting Alarms** for details.
- The “Level” field indicates the alarm level: H means high, M means medium and L means low. “*” means the alarm level is user-adjustable.
- XX represents a measurement or parameter label or module, such as ECG, NIBP, HR, ST-I, PVCs, RR, SpO₂, PR, etc.

In the “Cause and Solution” column, corresponding solutions are given instructing you to troubleshoot problems. If the problem persists, contact your service personnel.

D.1 Physiological Alarm Messages

Measurement	Alarm messages	Level	Cause and solution
XX	XX Too High	M*	XX value has risen above the high alarm limit or fallen below the low alarm limit. Check the patient’s condition and check if the patient category and alarm limit settings are correct.
	XX Too Low	M*	
ECG	ECG Weak Signal	H	The ECG signal is too weak for the monitor to perform ECG analysis. Check the patient’s condition and the ECG connections.
	Asystole	H	Arrhythmia has occurred to the patient. Check the patient’s condition and the ECG connections.
	VFib/VTac	H	
	Vtac	H	
	Vent. Brady	H	
	Extreme Tachy	H	
	Extreme Brady	H	
	R on T	M*	
	Run PVCs	M*	
	Couplet	M*	
	PVCs/min	M*	
	Bigeminy	M*	
	Trigeminy	M*	
	Tachy	M*	
Brady	M*		

Measurement	Alarm messages	Level	Cause and solution	
	Missed Beats	M*		
	Afib	M*		
	Irr. Rhythm	M*		
	Vent. Rhythm	M*		
	Multif. PVC	M*		
	Nonsus. Vtac	M*		
	Pause	M*		
	Pacer Not Pacing	M*		The pacer appears abnormal. Check the pacer.
	Pacer Not Capture	M*		
Resp	Resp Apnea	H	The respiration signal was too weak for the monitor to perform respiration analysis. Check the patient's condition and the Resp connections.	
	Resp Artifact	H	The patient's heartbeat has interfered with his respiration. Check the patient's condition and the Resp connections.	
SpO ₂	SpO ₂ Desat	H	The SpO ₂ or SpO ₂ b value has fallen below the desaturation alarm limit. Check the patient's condition and check if the alarm limit settings are correct.	
	SpO ₂ b Desat			
	No Pulse	H	The pulse signal was too weak for the monitor to perform pulse analysis. Check the patient's condition, SpO ₂ sensor and measurement site.	
CO ₂	CO ₂ Apnea	H	The patient stops breathing, or the respiration signal was too weak for the monitor to perform respiration analysis. Check the patient's condition and the RM connections.	
AG	AG Apnea	H		
RM	RM Apnea	H		
AG	FiO ₂ Too Low	H	Check the patient's condition, the ventilated O ₂ content and the AG connections.	
tcGas	+tcpCO ₂ Alarm	M*	Parameter value has risen above the high alarm limit or fallen below the low alarm limit. Check the patient's condition and check if the patient category and alarm limit settings are correct.	
	+tcpO ₂ Alarm	M*		
	+SpO ₂ Alarm	M*		
	+PR Alarm	M*		
NMT	TOF Alarm	M*	For TOF – Watch SX monitor only. TOF value has risen above the high alarm limit or fallen below the low alarm limit. Check the patient's condition and check if the patient category and alarm limit settings are correct.	

D.2 Technical Alarm Messages

Measurement	Alarm message	Level	I	Cause and solution
XX	XX SelfTest Err	H	C	An error occurred to the XX module, or there is a problem with the communications between the module and the monitor. Re-plug the module and restart the monitor, or plug the module into another monitor.
	XX Init Err	H	A	
	XX Init Err N(N is between 1 to 8)	H	A	
	XX Comm Err	H	A	
	XX Comm Stop	H	C	
	XX Limit Err	L	C	XX parameter limit is accidentally changed. Contact your service personnel.
	XX Overrange	L	C	The measured XX value is not within the specified range for XX measurement. Contact your service personnel.
MPM	MPM 12V Err	H	C	An error occurred to the power supply part of the MPM module. Contact your service personnel.
	MPM 5V Err	H	C	
T1/N1	Transfer Module battery to be protected and not work.	H	C	The battery will be soon protected and will not supply power. If you are going to use T1/N1 for patient transport, please replace the battery.
	Transfer Module battery aged. Replace the battery	L	C	Replace the battery.
	Transfer Module No Battery	H	C	T1/N1 has no battery. Install a battery for T1/N1.
	PWR interrupted. Check meas. state	L	A	Power supply failed accidentally. Check the measurements when the monitor restarts.
	High Technical Alarm	H	C	T1/N1 has a high/medium/low technical alarm. Check the T1/N1 monitor for the alarm.
	Medium Technical Alarm	M	C	
	Low Technical Alarm	L	C	
ECG	ECG Lead Off	L*	B	The electrode has become detached from the patient or the lead wire has become disconnected from the adapter cable. Check the connections of the electrodes and leadwires.
	ECG YY Lead Off	L*	B	
	Note: YY represents the leadwires, V (V1, V2, V3, V4, V5, V6), LL, LA, RA, as per AHA standard, or C (C1, C2, C3, C4, C5, C6), F, L and R as per IEC standard.			
	ECG Noisy	L	A	The ECG signal is noisy. Check for any possible sources of signal noise around the cable and electrode, and check the patient for great motion.
	ECG High Freq. Noise	L	A	High frequency signals are detected on the ECG analysis lead. Check for any possible source of interference around the cable and electrode.

Measurement	Alarm message	Level	I	Cause and solution
	ECG Low Freq. Noise	L	A	Low frequency signals are detected on the ECG analysis lead. Check for any possible source of interference around the cable and electrode.
	ECG Amplitude Too Small	L	C	The ECG amplitude didn't reach the detected threshold. Check for any possible source of interference around the cable and electrode.
	ECG Config. Err	L	C	ECG configuration is wrongly downloaded. Check the downloaded configuration and re-download the correct configuration.
Resp	Resp Disturbed	L	A	The respiration circuit is disturbed. Restart the monitor.
Temp	Temp Cal. Err	H	C	A calibration failed. Restart the monitor.
	T1 Sensor Off	L	A	The Temp sensor has become detached from the patient or the module. Check the sensor connections.
	T2 Sensor Off	L	A	
SpO ₂	SpO ₂ Sensor Off	L*	B	The SpO ₂ sensor has become detached from the patient or the module, or there is a fault with the SpO ₂ sensor, or an unspecified SpO ₂ sensor has been used. Check the sensor application site and the sensor type, and make sure if the sensor is damaged. Reconnect the sensor or use a new sensor.
	SpO ₂ b Sensor Off			
	SpO ₂ Sensor Fault	L	C	
	SpO ₂ b Sensor Fault			
	SpO ₂ No Sensor	L	B	
	SpO ₂ b No Sensor			
	SpO ₂ Unknown Sensor	L	C	
	SpO ₂ b Unknown Sensor			
	SpO ₂ Sensor Incompatible	L	C	
	SpO ₂ b Sensor Incompatible			
	SpO ₂ Too Much Light	L	C	There is too much light on the SpO ₂ sensor. Move the sensor to a place with lower level of ambient light or cover the sensor to minimize the ambient light.
	SpO ₂ b Too Much Light			
	SpO ₂ Low Signal	L	C	The SpO ₂ signal is too low or too weak. Check the patient's condition and change the sensor application site. If the error persists, replace the sensor.
	SpO ₂ b Low Signal			
	SpO ₂ No Pulse	L	C	The SpO ₂ sensor failed to obtain pulse signal. Check the patient's condition and change the sensor application site. If the error persists, replace the sensor.
	SpO ₂ b No Pulse			
SpO ₂ Interference	L	C	The SpO ₂ signal has been interfered. Check for any possible sources of signal noise around the sensor and check the patient for great motion.	
SpO ₂ b Interference				
	SpO ₂ Comm Abnormal	H	A	An error occurred to the SpO ₂ measurement module, or there is a problem with the

Measurement	Alarm message	Level	I	Cause and solution	
	SpO ₂ b Comm Abnormal			communications between the module and the monitor. Re-plug the module and restart the monitor, or plug the module into another monitor.	
	SpO ₂ Board Fault	L	C	There is a problem with the SpO ₂ measurement board. Do not use the module and contact your service personnel.	
	SpO ₂ b Board Fault				
	SpO ₂ b has been closed	H	C	Different types of SpO ₂ measurement modules are applied. Use the same type of SpO ₂ measurement modules.	
NIBP	NIBP Loose Cuff	L	A	The NIBP cuff is not properly connected, or there is a leak in the airway.	
	NIBP Air Leak	L	A		
	NIBP Pneumatic Leak	L	A	Check the NIBP cuff and pump for leakages.	
	NIBP Cuff Type Wrong	L	A	The cuff type applied mismatches the patient category. Verify the patient category and replace the cuff.	
	NIBP Air Pressure Err	L	A	An error occurred to the air pressure. Verify that the monitor application site meets the environmental requirements and check if there is any source that affects the air pressure.	
	NIBP Weak Signal	L	A	The patient's pulse is weak or the cuff is loose. Check the patient's condition and change the cuff application site. If the error persists, replace the cuff.	
	NIBP Signal Saturated	L	A	The NIBP signal is saturated due to excess motion or other sources.	
	NIBP Overrange	L	A	The measured NIBP value is not within the specified range.	
	NIBP-XX Over Upper Limit	L	A	The measured pressure is greater than the specified NIBP measurement upper limit.	
	NIBP-XX Over Lower Limit	L	A	The measured pressure is lower than the specified NIBP measurement lower limit.	
	XX represents diastolic pressure, mean pressure, or systolic pressure.				
	NIBP Excessive Motion	L	A	Check the patient's condition and reduce the patient motion.	
	NIBP Cuff Overpress.	L	A	The NIBP airway may be occluded. Check the airway and measure again.	
	NIBP Equip Err	H	A	An error occurred during NIBP measurement and therefore the monitor cannot perform analysis correctly. Check the patient's condition and NIBP connections, or replace the cuff.	
	NIBP Timeout	L	A		
	NIBP Measure Failed	L	A		

Measurement	Alarm message	Level	I	Cause and solution
	NIBP Illegally Reset	L	A	An illegal reset occurred during NIBP measurement. Check if the airway is occluded.
IBP	YY Sensor Off	M*	A	Check the sensor connection and reconnect the sensor.
	YY Disconnected	H	C	The liquid way is disconnected from the patient, or the three-way valve is open to the air. Check the connection of the liquid way, or check the valve is open to the patient. If the problem remains, contact the Customer Services Dept. for help.
	YY Sensor Fault	M	C	Replace the sensor.
	YY No Pulse	L	A	The catheter may be occluded. Please flush the catheter.
	YY represents an IBP label.			
C.O.	TB Sensor Off	L	A	Check the sensor connection and reconnect the sensor.
ScvO ₂	Optical Module Err	L	C	Check the module connection. Change a module if necessary.
	ScvO ₂ Signal Too High	L	C	Check the sensor and reposition the catheter, then recalibrate the sensor.
	ScvO ₂ Signal Too Low	L	C	
	ScvO ₂ Too Much Light	L	C	Check and reposition the catheter, then recalibrate the sensor. Avoid the backlight which is excessively strong.
	Optical Module Disconnected	L	A	Connect the optical module.
	ScvO ₂ Comm Abnormal	H	A	Remove/connect the module again or restart the machine. If the problem remains, contact the Customer Services Dept. for help.
	ScvO ₂ Comm Err	H	A	
	ScvO ₂ Init Err	H	A	Remove/connect the module again. If the problem remains, contact the Customer Services Dept. for help.
	Unsupported CeVOX version	H	A	The module version is not compatible with the system. Please contact the Customer Services Dept. for help.
	ScvO ₂ Comm Stop	H	A	Remove/connect the module again or restart the machine. If the problem remains, contact the Customer Services Dept. for help.
Disconnect from Vigilance	L	C	The Vigilance II monitor is disconnected from the host monitor Check the connection between the Vigilance II monitor and the host monitor.	

Measurement	Alarm message	Level	I	Cause and solution
	Disconnects from Vigileo	L	C	The Vigileo™ monitor is disconnected from the host monitor. Check the connection between the Vigileo™ monitor and the host monitor.
	Disconnect From EV1000	L	C	The EV1000 monitor is disconnected from the host monitor. In this case, check the connection between the EV1000 monitor and the host monitor. When EV1000 monitor works in VolumeView mode, finishes measurement, and then admits a new patient, this alarm is issued. In this case, perform one measurement after admitting a new patient at the EV1000 monitor. When the information of a new patient is not entered into the EV1000 within 30 seconds, this alarm is issued. In this case, enter the patient information within 30 seconds.
CO ₂	CO ₂ Sensor High Temp	L	C	Check, stop using or replace the sensor.
	CO ₂ Sensor Low Temp	L	C	Check, stop using or replace the sensor.
	CO ₂ Temp Overrange	L	C	The operating temperature of the CO ₂ module goes beyond the specified range. After it restores within the specified range, the module will restart automatically.
	CO ₂ Airway High Press.	L	C	An error occurred in the airway pressure.
	CO ₂ Airway Low Press.	L	C	Check the patient connection and patient circuit, and then restart the monitor.
	CO ₂ High Barometric Press.	L	C	Check the CO ₂ connections, make sure that the monitor application site meets the requirements, and check for special sources that affect the ambient pressure. Restart the monitor.
	CO ₂ Low Barometric Press.	L	C	
	CO ₂ FilterLine Occluded	L	C	The airway or watertrap was occluded. Check the airway and remove the occlusion.
	CO ₂ No Watertrap	L	B	Check the watertrap connections.
	CO ₂ Check Adapter	L	A	There is a problem with the airway adapter. Check, clean or replace the adapter.
	CO ₂ FilterLine Err	L	C	Check if there is a leak in the CO ₂ sample line or the CO ₂ sample line has been occluded.
	CO ₂ Zero Failed	L	A	Check the CO ₂ connections. After the sensor's temperature becomes stabilized, perform a zero calibration again.
	CO ₂ System Err	L	A	Re-plug the module or restart the monitor.
CO ₂ Check Cal.	L	C	Perform a calibration.	

Measurement	Alarm message	Level	I	Cause and solution
	CO ₂ Check Airway	L	C	An error occurred to the airway.
	CO ₂ No Filterline	L	A	Make sure that the filterline is connected.
	CO ₂ No Sensor	L	A	Make sure that the sensor is connected.
	CO ₂ Main Board Err	H	C	There is a problem with the CO ₂ module. Re-plug the module or restart the monitor.
	CO ₂ Checking Sensor	L	C	
	CO ₂ Replace Scrubber&Pump	L	C	
	CO ₂ 15V Overrange	H	C	
	CO ₂ Hardware Err	H	C	
tcGas	tcGas Low Battery	M	C	Connect the TCM monitor or SenTec Digital Monitor with AC mains.
	tcGas Battery Depleted	H	C	TCM monitor or SenTec Digital Monitor has less than 5 minutes running time on battery. Connect the TCM monitor or SenTec Digital Monitor with AC mains immediately.
	TCM Temperature Too High	H	C	The temperature in TCM CPU is too high. Please shut down TCM monitor immediately.
	TCM Alert	L	C	A TCM technical alarm is presented. Please check the TCM monitor to identify the cause of alarm.
AG	AG No Watertrap	L	B	Check the connections of the watertrap and re-connect it.
	AG Change Watertrap	L	A	Wait until the change is completed.
	AG Watertrap Type Wrong	L	A	Make sure that a correct watertrap has been used.
	O ₂ Accuracy Unspecified	L	A	The measured value has exceeded the specified accuracy range.
	N ₂ O Accuracy Unspecified	L	A	
	CO ₂ Accuracy Unspecified	L	A	
	Enf Accuracy Unspecified	L	A	
	Iso Accuracy Unspecified	L	A	
	Sev Accuracy Unspecified	L	A	
	Hal Accuracy Unspecified	L	A	
	Des Accuracy Unspecified	L	A	
	awRR Accuracy Unspecified	L	A	
	AG Hardware Err	H	A	
	AG Airway Occluded	L	A	Check the airway and remove the occlusion.
AG Zero Failed	L	A	Re-plug the module or restart the monitor, and then perform a zero calibration again.	
NMT (Mindray)	NMT No Main Cable	L	A	Check that NMT patient cable is properly connected to the NMT module.
	NMT Sensor Fault	L	C	The NMT sensor has a fault. Reconnect or replace the sensor.

Measurement	Alarm message	Level	I	Cause and solution
	NMT No Sensor	L	A	Check that NMT sensor is properly connected to the NMT patient cable. If the alarm persists, replace the sensor.
	NMT Stimulation Electrode Off	L	A	Check that NMT sensor is properly connected to the NMT patient cable. If the alarm persists, check the application of electrodes.
	NMT Stimulation Current Over Limit	L	C	The output stimulation current exceeds the specification. Contact your service personnel.
	NMT Power Err	H	A	Contact your service personnel.
	NMT Abnormal Reset	L	A	Take out the NMT module and plug it again in the module rack. Restart the monitor or test the module with another Passport m Series monitor. If the problem persists, contact your service personnel.
NMT (TOF-Watch® SX)	TWSX Low Battery	M	C	Replace the battery.
	TWSX Battery Depleted	H	C	Replace the battery.
	TWSX No Acceleration Sensor	L	B	Connect the acceleration sensor.
	TWSX No Temp Sensor	L	B	Connect the temperature sensor.
	TWSX No Stimulation Cable	L	B	Connect the stimulation cable.
	TWSX Bad Electrode Connection	L	B	Reattach the electrode.
	TWSX Technical Alarm	L	C	An NMT technical alarm is presented. Please check the TOF-Watch® SX monitor to identify the cause of alarm.
RM	RM No Sensor	L	A	Check and reconnect the sensor.
	RM Sensor Reversed	L	C	
	RM Zero Failed	L	C	Perform a zero calibration again.
	RM Power Err	L	A	There is a problem with the power supply. Re-plug the module or restart the monitor.
BIS	BIS High Imped.	L	A	Check and reconnect the BIS sensor.
	BIS Sensor Off	L	A	
	BIS DSC Err	L	C	An error occurred to the DSC during receiving signals. Check the DSC.
	BIS DSC Malf	L	C	The DSC automatically shuts down as a result of malfunction. Check the DSC.
	BIS No Cable	L	A	Check the BIS cables.
	BISx Disconnected	L	A	Check the BISx module.
	BIS No Sensor	L	A	Check the BIS sensor.
	BIS Wrong Sensor Type	L	A	Check or replace the sensor.
	BIS Sensor Too Many Uses	L	A	Replace the sensor.
	SQI<50%	L	A	The SQI value is too low. Check the patient's condition and the sensor connections.
	SQI<15%	L	A	
	BIS Sensor Expired	L	A	Replace the sensor.
BIS Sensor Fault	L	C	Re-attach or Replace BIS Sensor	

Measurement	Alarm message	Level	I	Cause and solution
	Disconnect/Reconnect BIS	L	C	Re-plug the BIS Module
Power	12V Too High	H	C	There is a problem with the system power supply. Restart the monitor.
	12V Too Low	H	C	
	5V Too High	H	C	
	5V Too Low	H	C	
	3.3V Too High	H	C	
	3.3V Too Low	H	C	
	Battery Too Low	H	C	Connect the monitor to an AC power source and allow the batteries to charge.
	Battery Overload	H	C	Too many parameter modules are connected, causing system overload and high power consumption. Use AC power supply.
	Transfer Module battery to be protected and not work.	H	C	T1/N1 battery will be soon protected and will not supply power. If you are going to use the T1/N1 for patient transport, please replace the battery.
	Transfer Module battery aged. Replace the battery	L	C	T1/N1 battery lifetime is expired. Replace the battery with a new one.
iView operates abnormally. Please use AC.	H	C	When batteries are used as the power source, iView system can not properly work. If you want to use iView system, please power the monitor with an AC power source.	
RT Clock Need Reset	L	C	Internal backup battery cell fails. Contact your service personnel.	
RT Clock Not Exist	H	C	Contact your service personnel.	
Recorder	Recorder Init Err N	L	A	Restart the monitor.
	N is within 1 to 8.			
	Recorder SelfTest Err	L	A	Stop the recording and restart the monitor.
	Recorder Comm Err	L	A	
	Recorder S. Comm Err	L	A	
	Recorder Unavailable	L	A	
	Recorder Vlt High	L	C	An error occurred to the system power supply. Restart the monitor.
	Recorder Vlt Low	L	C	
	Recorder Head Hot	L	C	The recorder has been working for too long time. Stop the recording and resume the recording till the recorder's printhead cools down.
Rec Paper Wrong Pos.	L	A	Re-load the recorder paper.	
System	IP Address Conflict	L	A	Set a new IP address.
	No CMS	L	A	The monitor is disconnected from the CMS. Check network connection.

Measurement	Alarm message	Level	I	Cause and solution
	Other Bed Disconnected	L	A	Check network connection.
	PWR interrupted. Check meas. state	L	A	Power supply failed accidentally. Check the measurements when the monitor restarts.
	Restoring Last Config. Failed	L	A	Restart the monitor. If the problem persists, there may be an EEPROM failure. Contact your service personnel.
	Loading Default Config. Failed.	L	A	Restart the monitor. If the problem persists, there may be an EEPROM failure. Contact your service personnel.
	USB Drive Err	M	A	Disconnect the USB memory and reconnect it properly. If the problem persists, format the USB memory. If the problem still persists, replace the USB drive.
	Storage Card Err	M	C	Restart the monitor. If the problem persists, format the SD card.
	Storage Card Space Low	L	B	The storage card has abnormal data. Format the storage card.
	USB Drive Space Low	L	A	Delete unnecessary data from the USB memory, or replace the USB memory.

FOR YOUR NOTES

E SpO₂ Sensor Accuracy

A.1 Accuracy of Masimo SpO₂ Sensors

Table information for the plots below show ARMS values measured with Masimo SET Oximetry Technology in a clinical study.

DCI/DCIP/4050/4051

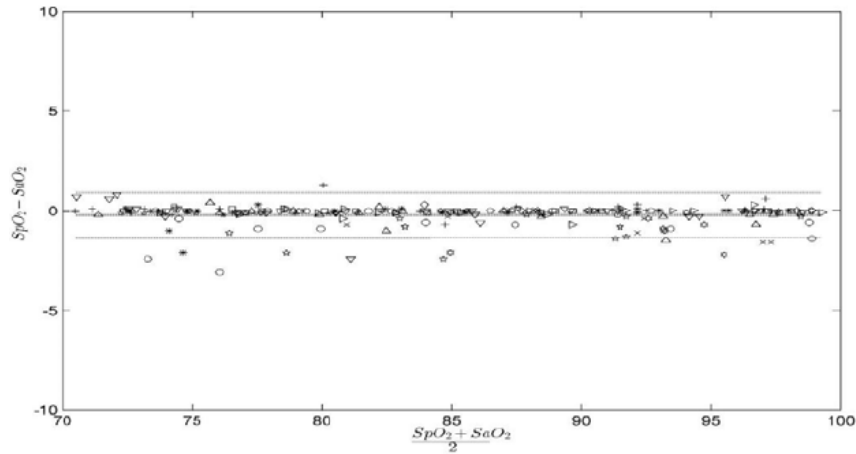

MEASURED ARMS VALUES	
Range	ARMS
90-100%	0.60%
80-90%	0.54%
70-80%	0.67%
Range	ARMS
70-100%	2 %
Overall Claimed Accuracy Value	

4053

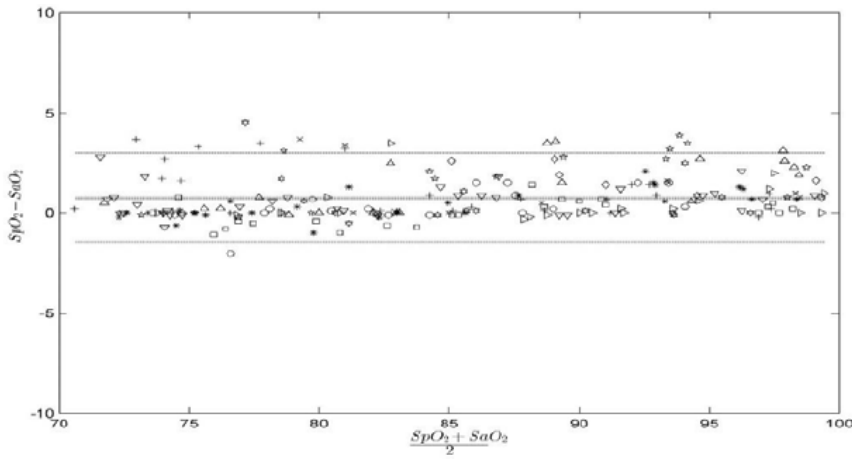

MEASURED A_{RMS} VALUES	
Range	A_{RMS}
90-100%	1.45%
80-90%	1.22%
70-80%	1.41%

Range	A_{RMS}
70-100%	2 %

Overall Claimed Accuracy Value

Inf/Neo/NeoPt/4002/4003/4004/4005

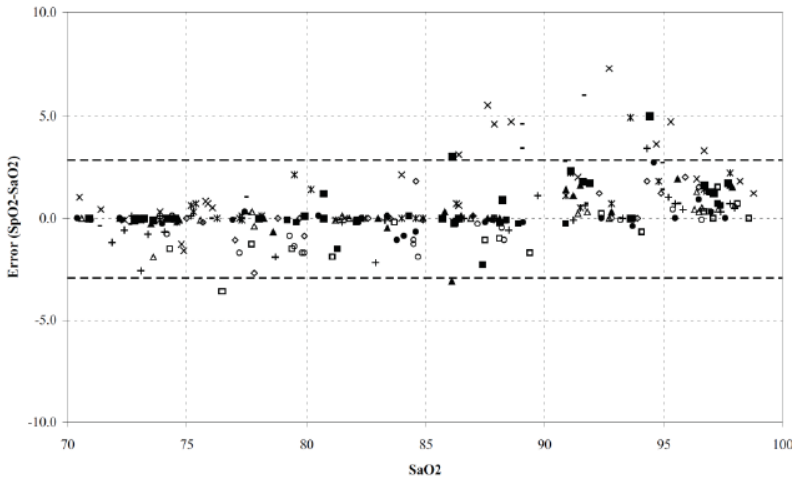

MEASURED A_{RMS} VALUES	
Range	A_{RMS}
90-100%	1.85%
80-90%	1.44%
70-80%	0.89%

Range	A_{RMS}		
	Inf	Neo*	Neo Pt*
70-100%	± 2 %	±2 % Adult ±3 % Neonatal	±3 %

Overall Claimed Accuracy Value

*The saturation accuracy of the Neonate and Preterm sensors were validated on adult volunteers and 1% was added to account for the properties of fetal hemoglobin.

Adtx/Pdtx/4000/4001

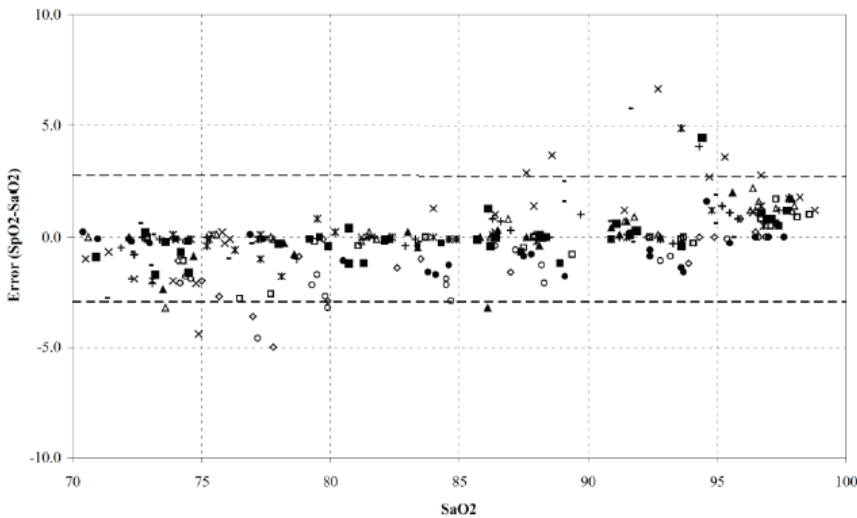

MEASURED A_{RMS} VALUES	
Range	A_{RMS}
90-100%	1.64%
80-90%	1.07%
70-80%	1.55%

Range	A_{RMS}
70-100%	± 2 %

Overall Claimed Accuracy Value

A.2 Accuracy of Nellcor SpO₂ Sensors

■ SpO₂ Accuracy for Nellcor™ Sensors vs. Co-Oximeters

SpO ₂ Range	100% to 70%	100% to 90%	90% to 80%	80% to 70%
DS-100A	1.64%	1.16%	1.67%	2.25%
OXI-P/I, OXI-A/N	2.41%	1.38%	2.50%	3.60%
MAX-AI, MAX-PI, MAX-II	1.62%	1.49%	1.57%	2.50%
MAX-NI	1.85%	1.71%	1.51%	1.59%

■ Modified Bland-Altman for SpO₂-DS-100A Sensor: (SpO₂ - SaO₂) vs. SaO₂

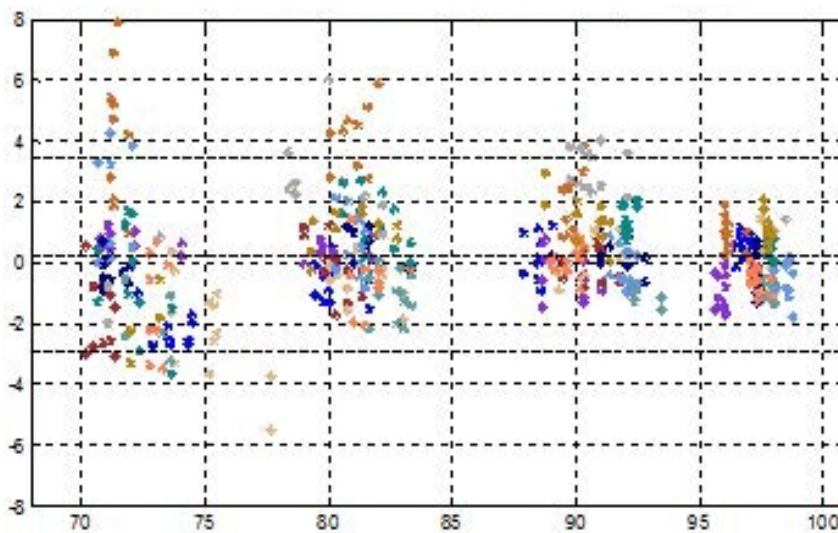

■ Modified Bland-Altman for SpO₂-OXI-P/I, OXI-A/N Sensors: (SpO₂ - SaO₂) vs. SaO₂

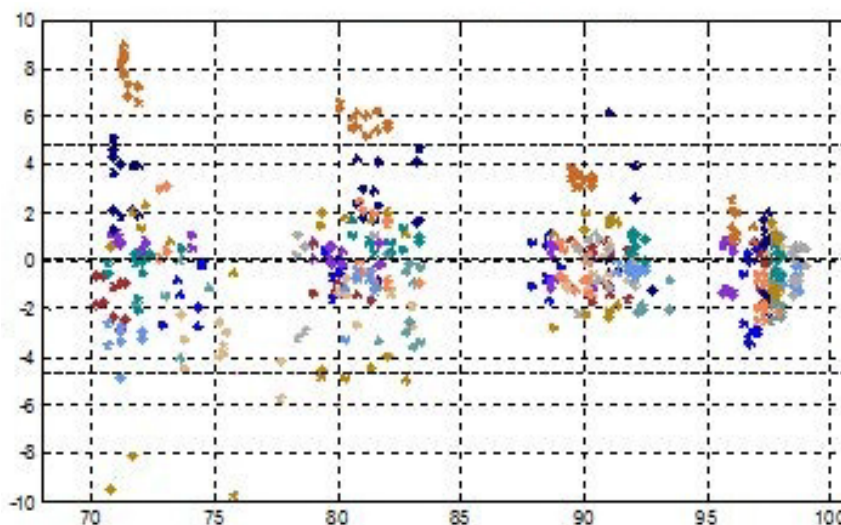

■ Modified Bland-Altman for SpO₂- MAX-AI, MAX-AI, MAX-PI, MAX-II Sensors: SaO₂ vs. (SpO₂ - SaO₂)

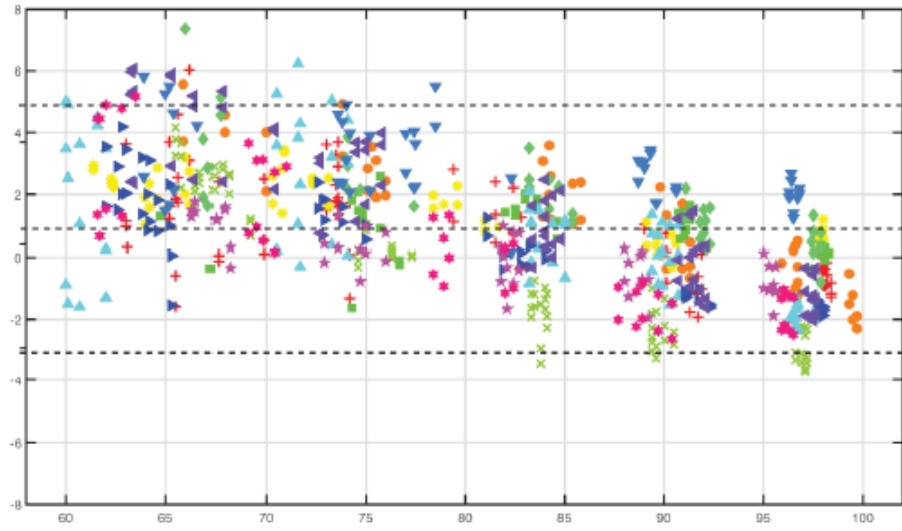

■ Modified Bland-Altman for SpO₂- MAX-NI Sensor: SaO₂ vs. (SpO₂ - SaO₂)

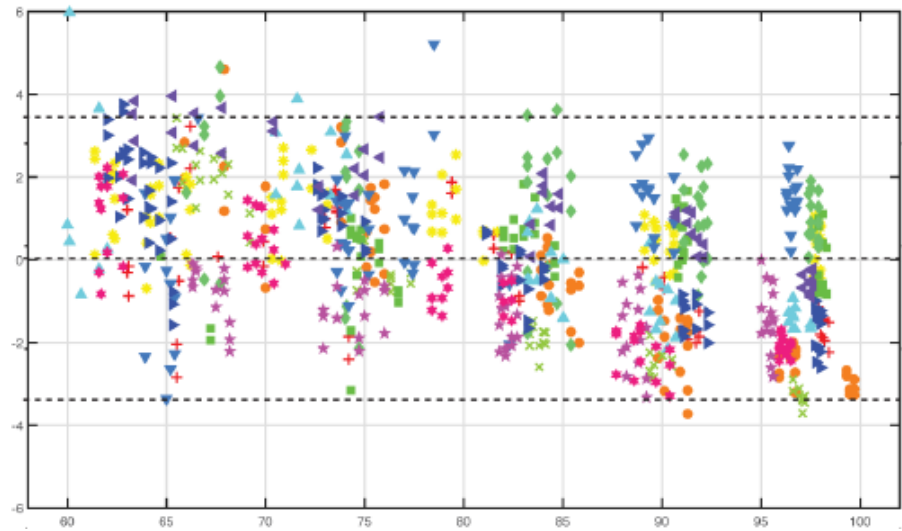

F Symbols and Abbreviations

F.1 Symbols

μA	microampere
μV	microvolt
μs	Microsecond
A	ampere
Ah	ampere hour
bpm	beat per minute
bps	bit per second
$^{\circ}\text{C}$	centigrade
cc	cubic centimeter
cm	centimeter
dB	decibel
DS	dyne second
$^{\circ}\text{F}$	fahrenheit
g	gram
GHz	gigahertz
GTT	gutta
h	hour
Hz	hertz
in	inch
kg	kilogram
kPa	kilopascal
L	litre
lb	pound
m	meter
mAh	milliampere hour
Mb	mega byte
mcg	microgram
mEq	milli-equivalents
mg	milligram
min	minute
ml	milliliter
mm	millimeter
mmHg	millimeters of mercury
cmH ₂ O	centimeters of water
ms	millisecond
mV	millivolt
mW	milliwatt
M Ω	megaohm

nm	nanometer
rpm	breath per minute
s	second
V	volt
VA	volt ampere
Ω	ohm
W	watt
–	minus, negative
%	percent
/	per; divide; or; none; not applicable
+	plus
=	equal to
<	less than
>	greater than
≤	less than or equal to
≥	greater than or equal to
±	plus or minus
×	multiply

F.2 Abbreviations

AaDO ₂	alveolar-arterial oxygen gradient
AAMI	Association for Advancement of Medical Instrumentation
AC	alternating current
ACI	acceleration index
Adu	adult
AG	anaesthesia gas
AHA	American Heart Association
air cyl.	Air cylinder pressure
Air Flow	air flow
ANSI	American National Standard Institute
Ao	aortic pressure
Art	arterial
ATMP	Barometric pressure
aVF	left foot augmented lead
aVL	left arm augmented lead
aVR	right arm augmented lead
awRR	airway respiratory rate
BAP	brachial arterial pressure
Base Flow	base flow
BC	burst count
BIS	bispectral index

BP	blood pressure
BPSK	binary phase shift keying
BSA	body surface area
BT	blood temperature
BTPS	body temperature and pressure, saturated
C.I.	cardiac index
CCI	Continuous Cardiac Index
Cdyn	dynamic compliance
CCO	Continuous Cardiac Output
CaO ₂	arterial oxygen content
CCO	continuous cardiac output
CCU	cardiac (coronary) care unit
CE	Conformité Européenne
CFI	cardiac function index
CIS	Clinical Information System
CISPR	International Special Committee on Radio Interference
CMOS	complementary metal oxide semiconductor
CMS	central monitoring system
C.O.	cardiac output
CO ₂	carbon dioxide
COHb	carboxyhemoglobin
Compl	compliance
CP	cardiopulmonary
CPI	cardiac power index
CPO	Cardiac Power Output
Cstat	static compliance
CVP	central venous pressure
DC	direct current
Des	desflurane
Dia	diastolic
DPI	dot per inch
dPmx	left ventricular contractility
DVI	digital video interface
DO ₂	oxygen delivery
DO ₂ I	oxygen delivery index
ECG	electrocardiograph
EDV	end-diastolic volume
EE	Energy expenditure
EEC	European Economic Community
EEG	electroencephalogram
EMC	electromagnetic compatibility
EMG	electromyography
EMI	electromagnetic interference
Enf	enflurane
ESU	electrosurgical unit

ESV	end systolic volume
ESVI	end systolic volume index
Et	end-tidal
EtAA	End-tidal anesthetic agent
EtAA 2nd	2nd Exp. Agent
EtDes	end-tidal anesthetic agent
EtEnf	
EtHal	
EtIso	
EtSev	
EtCO ₂	end-tidal carbon dioxide
EtN ₂ O	end-tidal nitrous oxide
EtO	ethylene oxide
EtO ₂	end-tidal oxygen
ELWI	extravascular lung water index
EVLW	extravascular lung water
Exp%	expiration termination level
Exp. Flow	expiratory flow
Exp. MAC	Expired minimum alveolar concentration
f	breath rate
FAP	femoral arterial pressure
fapnea	breath rate for apnea ventilation
FCC	Federal Communication Commission
fCMV	CMV frequency
FDA	Food and Drug Administration
FEV1.0%	first second forced expiratory volume ratio
FG	Fresh gas flow
Fi	fraction of inspired
FiAA	Inspired anesthetic agent
FiAA 2nd	2nd Insp. Agent
FiDes	inspired anesthetic agent
FiEnf	
FiHal	
FiIso	
FiSev	
FiCO ₂	fraction of inspired carbon dioxide
FiN ₂ O	fraction of inspired nitrous oxide
FiO ₂	fraction of inspired oxygen
Flow	flow
fmand	mandatory breathing frequency
FPGA	field programmable gate array
FRC	Fractional residual capacity
FreqMIN	minimum breath frequency
fsigh	sigh rate
fSIMV	frequency of SIMV

fspn	spontaneous breathing frequency
ftot	total breath rate
F-Trigger	inspiratory trigger level (flow trigger)
FV	flow-volume
GEDV	global end diastolic volume
GEDI	global end diastolic volume index
GEF	global ejection fraction
Hal	halothane
Hct	haematocrit
Hb	hemoglobin
Hb-CO	carbon mono-oxide hemoglobin
HbO ₂	oxyhemoglobin
HIS	hospital information system
HR	heart rate
I:E	inspiratory-expiratory ratio
IBP	invasive brood pressure
IBW	ideal body weight
ICP	intracranial pressure
ICT/B	intracranial catheter tip pressure transducer
ICU	intensive care unit
ID	identification
I:E	inspiratory time: Expiratory time ratio
IEC	International Electrotechnical Commission
IEEE	Institute of Electrical and Electronic Engineers
Ins	inspired minimum
Insp.Flow	inspiration flow
Insp. MAC	Inspired minimum alveolar concentration
Δint.PEEP	intermittent PEEP
IP	internet protocol
Iso	isoflurane
IT	injectate temperature
ITBI	Intrathoracic Blood Volume Index
ITBV	Intrathoracic Blood Volume
LA	left arm
LAP	left atrial pressure
Lat	lateral
LCD	liquid crystal display
LCW	left cardiac work
LCWI	left cardiac work index
Leak Comp	leak compensation
LED	light emitting diode
LL	left leg
LVD	low voltage directive
LVDS	low voltage differential signal
LVET	left ventricular ejection time

LVSW	left ventricular stroke work
LVSWI	left ventricular stroke work index
MAC	minimum alveolar concentration
Art mean	mean arterial pressure
MDD	Medical Device Directive
MetHb	methemoglobin
%MinVol	Percentage of minute volume to be delivered
MRI	magnetic resonance imaging
MRN	medical record number
MV	minute volume
MVe	expiratory minute volume
MVi	inspiratory minute volume
MVLEAK	leakage minute volume
MVspn	spontaneous breathed minute volume
N/A	not applied
N ₂	nitrogen
N ₂ O	nitrous oxide
N ₂ O cyl.	N ₂ O cylinder pressure
N ₂ O Flow	N ₂ O flow
Neo	neonate
NIBP	noninvasive blood pressure
NIF	negative inspiratory force
NMT	neuromuscular transmission
O ₂	oxygen
Δ O ₂	Difference between inspiratory and expiratory O ₂
O ₂ %	oxygen concentration
O ₂ CI	oxygen consumption index
O ₂ cyl.	Oxygen cylinder pressure
O ₂ cyl.2nd	Secondary oxygen cylinder pressure
O ₂ EI	oxygen extraction index
O ₂ Flow	O ₂ flow
O ₂ R	oxygen extraction ratio
OR	operating room
oxyCRG	oxygen cardio-respirogram
PA	pulmonary artery
Pair	Air supply pressure
Papnea	apnea pressure
pArt-D	diastolic artery pressure
pArt-M	mean artery pressure
pArt-S	systolic artery pressure
Paux Mean	Mean auxiliary pressure
Paux Min	Minimum auxiliary pressure
Paux Peak	Peak auxiliary pressure
Paw	airway pressure
PAWP	pulmonary artery wedge pressure

PD	photodetector
Peak Flow	peak flow
Ped	pediatric
PEEP	positive end expiratory pressure
PEEP/CPAP	PEEP/CPAP
PEEPe	Extrinsic positive end-expiratory pressure
PEEPi	intrinsic positive end-expiratory pressure
PEEPi time	Intrinsic PEEP age (elapsed time since last maneuver)
PEEPtot	total PEEP
PEF	peak expiratory flow
PEP	pre-ejection period
Phigh	upper pressure level
PIF	peak inspiratory flow
Pinsp	pressure control level of inspiration
PIP	peak inspiratory pressure
Pleth	plethysmogram
Plimit	pressure limit level
Plow	lower pressure level
Pmax	maximum airway rressure
Pmean	mean pressure
PN ₂ O	N ₂ O supply pressure
PO ₂	Oxygen supply pressure
Ppeak	peak pressure
Pplat	plateau pressure
PPV	Pulse Pressure Variation
PR	pulse rate
Psupp	pressure support level
PTC	post tetanic count
PTP	Pressure time product
P-Trigger	inspiratory trigger level (pressure trigger)
PVC	premature ventricular contraction
PVR	pulmonary vascular resistance
PVRI	pulmonary vascular resistance index
PVPI	pulmonary vascular permeability index
pArt	artery pressure
pCVP	central venous pressure
P0.1	100 ms occlusion pressure
P0.1 time	P0.1 age (elapsed time since last maneuver)
R	right
RA	right arm
RAM	random access memory
Ramp	Ramp
RAP	right atrial pressure
RAW	airway resistance
RCexp	Expiratory time constant

RCinsp	Inspiratory time constant
Rdyn	dynamic lung resistance
Re	expiratory resistance
Rec	record, recording
Resp	respiration
RHb	reduced hemoglobin
Ri	inspiratory resistance
Rise Time%	rise time
RL	right leg
RM	respiratory mechanics
RQ	Respiratory quotient
RR	respiration rate
RSBI	rapid shallow breathing index
Rstat	static lung resistance
RVEF	right ventricular ejection fraction
SaO ₂	arterial oxygen saturation
SEF	spectral edge frequency
Sev	sevoflurane
SFM	self-maintenance
SI	stroke index
SMR	satellite module rack
SpO ₂	arterial oxygen saturation from pulse oximetry
SQI	signal quality index
SR	suppression ratio
STR	systolic time ratio
SV	stroke volume
SVI	Stroke Volume Index
SVR	systemic vascular resistance
SVRI	systemic vascular resistance index
SVV	stroke volume variation
SvO ₂	mixed venous oxygen saturation
ScvO ₂	central venous oxygen saturation
Sync	synchronization
Sys	systolic pressure
Tapnea	apnea interval
Taxil	axillary temperature
TB	Blood Temperature
TD	temperature difference
Temp	temperature
Texp	Expiratory time
TFC	thoracic fluid content
TFI	thoracic fluid index
TFT	thin-film technology
Thigh	time for the upper pressure level
Ti max	maximum inspiration time

T _{insp}	time of inspiration
T _{ip}	Inspiratory pause time
TIP:TI	percentage of inspiratory plateau time in inspiratory time
T _{low}	time for the lower pressure level
TOF	train of four
T _{oral}	oral temperature
TP	total power
T _{plat}	plateau time
TRC	Tube resistance compensation
T _{rect}	rectal temperature
Trigger	trigger sensitivity
Trig Window	trigger window
T _{rise}	rise time
T _{slope}	time for the pressure to rise to target pressure
Tube ID	tube ID
T _{Ve}	expiratory tidal volume
i	inspiratory tidal volume
UAP	umbilical arterial pressure
UPS	uninterruptible power supply
UVP	umbilical venous pressure
VAC	volts alternating current
VCO ₂	CO ₂ production
VEPT	volume of electrically participating tissue
VI	velocity index
VO ₂	oxygen consumption
VO ₂ /kg	Oxygen consumption per body weight
VO ₂ /m ²	Oxygen consumption per body surface area
VO ₂ l	oxygen consumption index
V _{Te} /T _{Ve}	expiratory tidal volume
V _{Ti} /T _{Vi}	inspiratory tidal volume
VT	tidal volume
V _{Tapnea}	apnea tidal volume
V _{Te spn}	spontaneous expiratory tidal volume
V _{Tsigh}	sigh tidal volume
WLAN	wireless local area network
WOB	work of breathing
WOB _{imp}	imposed work of breathing

FOR YOUR NOTES

