

BeneVision

TM70 Telemetry Monitor

Operator's Manual

© Copyright 2020-2022 Shenzhen Mindray Bio-Medical Electronics Co., Ltd. All rights reserved.

- Release time: March 2022
- Revision: 3.0

WARNING

- **Federal Law (USA) restricts this device to sale by or on the order of a physician or other practitioner licensed by U.S. state law to use or order the use of this device.**
-
-

Intellectual Property Statement

SHENZHEN MINDRAY BIO-MEDICAL ELECTRONICS CO., LTD. (hereinafter called Mindray) owns the intellectual property rights to this Mindray product and this manual. This manual may refer to information protected by copyrights or patents and does not convey any license under the patent rights of Mindray, nor the rights of others.

Mindray intends to maintain the contents of this manual as confidential information. Disclosure of the information in this manual in any manner whatsoever without the written permission of Mindray is strictly forbidden.

Release, amendment, reproduction, distribution, rental, adaption and translation of this manual in any manner whatsoever without the written permission of Mindray is strictly forbidden.

 **mindray**, **MINDRAY**, and **MINDRAY** are the registered trademarks or trademarks owned by Mindray in China and other countries. All other trademarks that appear in this manual are used only for editorial purposes without the intention of improperly using them. They are the property of their respective owners.

This posting serves as notice under 35 U.S.C. §287(a) for Mindray patents:

<http://www.mindrayna.com/patents>.

Manufacturer's Responsibility

Contents of this manual are subject to changes without prior notice.

All information contained in this manual is believed to be correct. Mindray shall not be liable for errors contained herein nor for incidental or consequential damages in connection with the furnishing, performance, or use of this manual.

Mindray is responsible for the effects on safety, reliability and performance of this product, only if:

- All installation operations, expansions, changes, modifications and repairs of this product are conducted by Mindray authorized personnel;
- The electrical installation of the relevant room complies with the applicable national and local requirements;
- The product is used in accordance with the instructions for use.

WARNING

- **Only skilled/trained clinical professionals should operate this equipment.**
-
-

- **It is important for the hospital or organization that employs this equipment to carry out a reasonable service/maintenance plan. Neglect of this may result in machine breakdown or personal injury.**
-
-

Company Contact

Manufacturer: Shenzhen Mindray Bio-Medical Electronics Co., Ltd.
Address: Mindray Building, Keji 12th Road South, High-tech Industrial park, Nanshan, Shenzhen 518057, P.R.China
Website: www.mindray.com
E-mail Address: service@mindray.com
Tel: +86 755 81888998
Fax: +86 755 26582680

Distributor: Mindray DS USA, Inc.
Address: 800 MacArthur Boulevard, Mahwah, New Jersey 07430 USA
Tel: 1.800.288.2121, 1.201.995.8000
Website: www.mindray.com

EC-Representative: Shanghai International Holding Corp. GmbH (Europe)
Address: Eiffestraße 80, 20537 Hamburg, Germany
Tel: 0049-40-2513175
Fax: 0049-40-255726

Preface

Manual Purpose

This manual contains the instructions necessary to operate the product safely and in accordance with its function and intended use. Observance of this manual is a prerequisite for proper product performance and correct operation and ensures patient and operator safety.

This manual is based on the maximum configuration and therefore some contents may not apply to your product. If you have any questions, please contact Mindray.

This manual is an integral part of the product. It should always be kept close to the equipment so that it can be obtained conveniently when needed.

Intended Audience

This manual is geared for clinical professionals who are expected to have a working knowledge of medical procedures, practices and terminology as required for monitoring of critically ill patients.

Illustrations

All illustrations in this manual serve as examples only. They may not necessarily reflect the setup or data displayed on your equipment.

Conventions

- *Italic text* is used in this manual to quote the referenced chapters or sections.
- **Bold text** is used to indicate the screen texts and names of hard keys.
- → is used to indicate operational procedures.

Contents

1 Safety	1 - 1
1.1 Safety Information	1 - 1
1.1.1 Warnings	1 - 1
1.1.2 Cautions	1 - 3
1.1.3 Notes	1 - 4
1.2 Equipment Symbols	1 - 5
2 General Product Description	2 - 1
2.1 Intended for Use	2 - 1
2.2 Applied Parts	2 - 1
2.3 System Components	2 - 2
2.4 TM70 Key Features	2 - 3
2.5 TM70 Components	2 - 4
2.6 TM70 Physical View	2 - 4
2.7 TM70 Touch Screen Display	2 - 5
2.7.1 Display Screen	2 - 6
2.7.2 On-Screen Keyboard	2 - 7
3 Getting Started	3 - 1
3.1 Unpacking and Checking	3 - 2
3.2 Environmental Requirements	3 - 2
3.3 Connecting the ECG Leadwire	3 - 3
3.4 Installing the Batteries	3 - 5
3.4.1 Installing the Lithium-ion Rechargeable Battery Pack	3 - 5
3.4.2 Installing the AA Batteries	3 - 6
3.5 Powering On the Unit	3 - 7
3.6 Understanding Touch Gestures	3 - 8
3.7 Basic Operations	3 - 8
3.7.1 Understanding the Screen Display Orientation	3 - 9
3.7.2 Browsing the Screen Display	3 - 9
3.7.3 Switching the Screen Display Orientation	3 - 9
3.7.4 Displaying the Quick Keys Area	3 - 10
3.7.5 Entering the Main Menu	3 - 10
3.7.6 Turning the Display Off	3 - 11
3.7.7 Turning the Display On	3 - 12
3.7.8 Unlocking the Screen in Locked Mode	3 - 12
3.7.9 Unlocking the Screen in View Only Mode	3 - 12
3.7.10 Acknowledging the Nurse Call	3 - 13
3.8 Using the Pouch	3 - 13
3.8.1 Securing the Pouch for the Telemetry Monitor	3 - 13
3.8.2 Securing Pouches for the Telemetry Monitor and BP10	3 - 15

4 User Configurations	4 - 1
4.1 Introduction	4 - 1
4.2 Configuring the Display	4 - 1
4.2.1 Setting the Default Display Orientation	4 - 1
4.2.2 Understanding Portrait Orientation Display Rules	4 - 1
4.2.3 Setting the Portrait Display	4 - 1
4.2.4 Understanding Landscape Orientation Display Rules	4 - 2
4.2.5 Setting the Landscape Display	4 - 2
4.2.6 Setting the Display Brightness	4 - 3
4.3 Configuring the Audio Volume	4 - 3
5 Patient Management	5 - 1
5.1 Introduction	5 - 1
5.2 Admitting a Patient	5 - 1
5.3 Changing Patient Information	5 - 1
5.3.1 Changing Last Name, First Name and Patient ID	5 - 1
5.3.2 Changing the Patient Category	5 - 1
5.3.3 Changing the Paced Status	5 - 2
5.3.4 Changing the Department Name, Room Number, and Bed Number	5 - 3
5.4 Entering the Standby Mode	5 - 3
5.5 Exiting the Standby Mode	5 - 4
5.6 Discharging the Patient	5 - 4
5.6.1 Selecting the Discharge Patient Menu	5 - 4
5.6.2 Restarting the Telemetry Monitor	5 - 5
6 Alarms	6 - 1
6.1 Introduction	6 - 1
6.2 Alarm Safety Information	6 - 1
6.3 Understanding the Alarms	6 - 2
6.3.1 Alarm Categories	6 - 2
6.3.2 Alarm Priorities	6 - 2
6.3.3 Alarm Indicators	6 - 2
6.3.4 Alarm Status Symbols	6 - 4
6.4 Viewing Alarms	6 - 4
6.5 Changing Alarm Settings	6 - 4
6.5.1 Changing the Alarm Volume	6 - 5
6.5.2 Initiating Auto Alarm Limits	6 - 5
6.5.3 Restoring Default Alarm Settings	6 - 6
6.6 Pausing Alarms	6 - 6
6.7 Resetting Alarms	6 - 7
6.7.1 Resetting Physiological Alarms	6 - 7
6.7.2 Resetting Technical Alarms	6 - 8
6.8 Latching Alarms	6 - 8

6.9 Actions When an Alarm Occurs	6 - 8
--	-------

7 Monitoring ECG, Arrhythmia, ST and QT 7 - 1

7.1 Introduction	7 - 1
7.2 ECG Safety Information	7 - 1
7.3 Preparation for Monitoring ECG	7 - 1
7.3.1 Preparing the Patient's Skin	7 - 2
7.3.2 Positioning the Electrodes	7 - 2
7.3.3 Configuring the ECG Lead Labeling	7 - 3
7.3.4 Placing the Electrodes	7 - 4
7.3.5 Checking the Lead Placement	7 - 9
7.3.6 Checking the Paced Status	7 - 10
7.3.7 Maintaining Quality ECG Signal	7 - 11
7.4 Changing ECG Settings	7 - 11
7.4.1 Entering the ECG Menu	7 - 11
7.4.2 Configuring ECG Settings	7 - 11
7.4.3 ECG Leadwire Types	7 - 12
7.4.4 Configuring ECG Waveforms	7 - 12
7.4.5 Configuring the Pacer	7 - 13
7.4.6 Configuring the ECG Waveform Size	7 - 14
7.4.7 Configuring ECG Alarm Settings	7 - 14
7.4.8 Configuring the Notch Filter	7 - 14
7.5 Configuring the HR Alarm Source	7 - 15
7.6 Understanding the ECG Display	7 - 15
7.6.1 HR Digital Area	7 - 15
7.6.2 About the HR Digital Area	7 - 16
7.6.3 ECG Waveform Area	7 - 16
7.6.4 About the ECG Waveform Area	7 - 16
7.7 Arrhythmia Monitoring	7 - 17
7.7.1 Arrhythmia Safety Information	7 - 17
7.7.2 Arrhythmia Events	7 - 17
7.7.3 Changing Arrhythmia Alarm Settings	7 - 19
7.7.4 Intelligent Arrhythmia Alarm	7 - 24
7.7.5 Understanding the Arrhythmia Display	7 - 25
7.8 ST Segment Monitoring	7 - 25
7.8.1 ST Safety Information	7 - 26
7.8.2 Enabling ST Monitoring	7 - 26
7.8.3 Displaying ST Numerics	7 - 26
7.8.4 Configuring ST Alarm Settings	7 - 27
7.9 QT/QTc Interval Monitoring	7 - 28
7.9.1 QT/QTc Monitoring Limitations	7 - 29
7.9.2 Enabling QT/QTc Monitoring	7 - 29
7.9.3 Displaying QT/QTc Numerics and Segments	7 - 30
7.9.4 Configuring QT/QTc Alarm Settings	7 - 30
7.10 Relearning	7 - 31

7.10.1 Automatically Initiating an ECG Relearning	7 - 31
7.10.2 Manually Initiating an ECG Relearning	7 - 31
8 Monitoring Respiration (Resp) (Optional)	8 - 1
8.1 Introduction	8 - 1
8.2 Resp Safety Information	8 - 1
8.3 Preparation for Monitoring Resp	8 - 2
8.3.1 Preparing the Patient's Skin	8 - 2
8.3.2 Positioning the Electrodes	8 - 2
8.4 Changing Resp Settings	8 - 3
8.4.1 Enabling/Disabling the Resp Functionality	8 - 3
8.4.2 Entering the Resp Menu	8 - 3
8.4.3 Configuring the Resp Setup	8 - 4
8.4.4 Configuring the Resp Waveform	8 - 4
8.4.5 Configuring Resp Alarm Settings	8 - 4
8.5 Understanding the Resp Display	8 - 5
8.5.1 Resp Digital Area	8 - 5
8.5.2 About the Resp Digital Area	8 - 6
8.5.3 Resp Waveform Area	8 - 6
8.5.4 About the Resp Waveform Area	8 - 6
9 Monitoring Pulse Oxygen Saturation (SpO2) (Optional)	9 - 1
9.1 Introduction	9 - 1
9.2 Measurement Limitations	9 - 1
9.3 Safety	9 - 3
9.4 Connecting the SpO2 Module	9 - 4
9.5 Changing the SpO2 Settings	9 - 6
9.5.1 Configuring the SpO2 Setup	9 - 6
9.5.2 Configuring the SpO2 Waveform	9 - 9
9.5.3 Configuring SpO2 Alarm Settings	9 - 9
9.6 SpO2 Measurement	9 - 10
9.6.1 Identifying SpO2 Modules	9 - 10
9.6.2 Applying the Sensor	9 - 11
9.7 Understanding the SpO2 Display	9 - 12
9.7.1 SpO2 Digital Area	9 - 12
9.7.2 About the SpO2 Digital Area	9 - 13
9.7.3 SpO2 Waveform Area	9 - 13
9.7.4 About the SpO2 Waveform Area	9 - 13
9.8 Masimo Information	9 - 14
9.9 Nellcor Information	9 - 14
10 Monitoring Noninvasive Blood Pressure (NIBP) (Optional)	10 - 1
10.1 Pairing Introduction	10 - 1
10.2 Pairing a Telemetry Monitor with a BP10	10 - 1

10.2.1	Pairing Procedures	10 - 1
10.2.2	System Responses after Successful Pairing	10 - 2
10.3	Unpairing the Telemetry Monitor with the BP10	10 - 3
10.3.1	Unpairing via the Telemetry Monitor	10 - 3
10.3.2	Unpairing via the BP10	10 - 4
10.3.3	System Responses after Successful Unpairing	10 - 4
10.4	Screen Display after Pairing a Telemetry Monitor with a BP10	10 - 5
10.5	Interactions after Pairing a Telemetry Monitor with a BP10	10 - 5
10.5.1	Overview of Interactions	10 - 5
10.5.2	Operating the BP10 via the Telemetry Monitor	10 - 6
10.5.3	Configuring NIBP Settings	10 - 6
10.5.4	Configuring NIBP Alarm Settings	10 - 7
11	Review	11 - 1
11.1	Introduction	11 - 1
11.2	Tabular Trends Review Page	11 - 1
11.2.1	Entering the Tabular Trends Review Page	11 - 1
11.2.2	Example Tabular Trends Review Page	11 - 1
11.2.3	Example Tabular Trends Data Search Page	11 - 3
11.2.4	Changing the Resolution of Trend Data	11 - 4
11.3	Events Review Page	11 - 4
11.3.1	Entering the Events Review Page	11 - 4
11.3.2	Example Events Review Page	11 - 5
11.3.3	Example Event Details Page	11 - 6
12	Configuring the Telemetry Monitor	12 - 1
12.1	Introduction	12 - 1
12.2	Entering the Maintenance menu	12 - 1
12.3	Configuring the General Menu	12 - 1
12.3.1	Configuring Device Location	12 - 2
12.4	Configuring the Alarms Menu	12 - 3
12.5	Quick Keys Menu	12 - 5
12.5.1	Changing the Quick Keys	12 - 5
12.5.2	Deleting a Quick Key	12 - 6
12.6	Configuring the Defaults Menu	12 - 6
12.6.1	Transferring a Configuration	12 - 7
12.7	Screen Lock Menu	12 - 8
12.7.1	Understanding the Screen Lock Mode	12 - 8
12.7.2	Setting the Screen Lock	12 - 8
12.7.3	Changing the Current Screen Lock Passcode	12 - 8
12.7.4	Changing the Screen Lock Mode	12 - 9
12.8	Changing the Passwords	12 - 9
12.9	Changing the Device Name	12 - 9

12.10 Auto Enter Monitor Mode	12 - 9
12.10.1 Understanding Auto Enter Monitor Mode	12 - 9
12.10.2 Configuring Auto Enter Monitor Mode	12 - 9
12.11 Using with a Patient Monitor	12 - 11
12.11.1 Confirm the Pairing of the Telemetry and the Monitor	12 - 11
12.11.2 Unpair the Telemetry with the Monitor	12 - 11
12.12 Demo Mode	12 - 11
12.13 Service Menu	12 - 11

13 Monitoring with the Telemetry Monitor at the CMS 13 - 1

13.1 Introduction	13 - 1
13.2 Network Safety Information	13 - 2
13.3 Adjusting the Minimum QRS Detection Threshold	13 - 2
13.4 Setting the Analysis Leads	13 - 3
13.5 QT Monitoring	13 - 3
13.5.1 Changing the QTc Formula	13 - 4
13.5.2 QT View	13 - 4
13.6 ST Monitoring	13 - 6
13.6.1 Adjusting ST Measurement Points	13 - 7
13.6.2 Entering the ST Graphic Window	13 - 7
13.6.3 Entering the ST View	13 - 8
13.7 Arrhythmia Monitoring	13 - 9
13.7.1 Configuring the PVC-Related Alarm Threshold	13 - 9
13.7.2 Configuring the Arrhythmia Shield Time	13 - 10
13.8 Locating the Telemetry Monitor	13 - 11
13.9 Sending a Notification to the Telemetry Monitor	13 - 11
13.10 Triggering an Alarm Reminding Patients' Location	13 - 11
13.11 Setting Authorization	13 - 12

14 Battery 14 - 1

14.1 Introduction	14 - 1
14.2 Safety	14 - 1
14.3 Installing the Battery	14 - 3
14.4 Checking the Battery Charge Status	14 - 3
14.5 Removing the Battery	14 - 3
14.6 Charging the Rechargeable Lithium-ion Battery	14 - 4
14.7 Storing the Batteries	14 - 5
14.7.1 Storing Rechargeable Lithium-ion Batteries	14 - 5
14.7.2 Storing AA Batteries	14 - 5
14.8 Maintaining the Rechargeable Lithium-ion Battery	14 - 5
14.9 Disposing of the Batteries	14 - 6
14.9.1 Disposing of the Rechargeable Lithium-ion Battery	14 - 6

14.9.2 Disposing of the AA Batteries	14 - 7
15 Troubleshooting	15 - 1
15.1 General Problems	15 - 1
15.2 Physiological Alarm Messages at the Telemetry Monitor	15 - 3
15.3 Technical Alarm Messages at the Telemetry Monitor	15 - 8
16 Cleaning and Disinfecting	16 - 1
16.1 Introduction	16 - 1
16.2 Safety Information	16 - 1
16.3 Cleaning and Disinfecting the Equipment	16 - 2
16.3.1 Approved Cleaning and Disinfecting Agents	16 - 2
16.3.2 Cleaning the Equipment	16 - 4
16.3.3 Disinfecting the Equipment	16 - 5
16.4 Cleaning and Disinfecting ECG Leadwires and SpO2 Sensors	16 - 6
16.5 Cleaning and Disinfecting Other Parts	16 - 6
16.6 Sterilization	16 - 7
16.7 Impact of Improper Cleaning or Disinfection	16 - 7
17 Maintenance	17 - 1
17.1 Introduction	17 - 1
17.2 Safety	17 - 1
17.3 Regular Check	17 - 2
17.4 Maintenance and Testing Schedule	17 - 3
17.5 Power-on Test	17 - 3
17.6 Verifying the ECG	17 - 4
17.7 NIBP Accuracy Test	17 - 4
17.8 NIBP Leakage Test	17 - 4
17.9 Nurse Call Test	17 - 4
17.10 Electrical Safety Tests	17 - 4
17.11 Battery Check	17 - 4
17.12 Viewing System Information	17 - 5
18 Accessories	18 - 1
18.1 ECG Accessories	18 - 1
18.1.1 ECG Electrodes	18 - 1
18.1.2 ECG Leadsets	18 - 2
18.2 SpO2 Accessories	18 - 2
18.2.1 Masimo SpO2 Module	18 - 3
18.2.2 Masimo Adapter Cable	18 - 3
18.2.3 Masimo SpO2 Sensor	18 - 3
18.2.4 Nellcor SpO2 Module	18 - 4
18.2.5 Nellcor SpO2 Sensor	18 - 4

18.3 NIBP Accessories	18 - 4
18.4 Miscellaneous	18 - 4
A Product Specifications	A - 1
A.1 Classifications	A - 1
A.2 Environmental Specifications	A - 1
A.3 Power Supply Specifications	A - 2
A.3.1 TM70	A - 2
A.3.2 Central Charger	A - 3
A.4 Physical Specifications	A - 3
A.5 Hardware Specifications	A - 3
A.5.1 TM70	A - 3
A.5.2 AP70	A - 4
A.5.3 AC70	A - 5
A.5.4 SYNC70	A - 5
A.5.5 Central Charger	A - 5
A.6 Data Storage	A - 6
A.7 Wireless Specification	A - 6
A.7.1 Mindray Patient Area Network (MPAN) Specification	A - 6
A.7.2 WMTS Specifications	A - 7
A.8 Measurement Specifications	A - 10
A.8.1 ECG	A - 10
A.8.2 Resp	A - 13
A.8.3 SpO2	A - 14
B EMC	B - 1
B.1 EMC	B - 1
C FCC Compliance	C - 1
D Symbols and Abbreviations	D - 1
D.1 Units	D - 1
D.2 Symbols	D - 2
D.3 Abbreviations	D - 2

1 Safety

1.1 Safety Information

WARNING

- Indicates a potential hazard or unsafe practice that, if not avoided, could result in death or serious injury.
-
-

CAUTION

- Indicates a potential hazard or unsafe practice that, if not avoided, could result in minor personal injury or product/property damage.
-
-

NOTE

- Provides application tips or other useful information to ensure that you get the most from your product.
-
-

1.1.1 Warnings

WARNING

- The telemetry monitor is intended to be used for a single patient at a time.
- The telemetry monitor must be operated by medical personnel in hospitals.
- For continued safe use of the telemetry monitor, the instructions given in this manual must be followed. But instructions in this manual in no way supersede established medical procedures.
- To avoid explosion hazard, do not use the telemetry monitor in the presence of oxygen-rich atmospheres, flammable anesthetics, or other flammable agents.
- The telemetry monitor is not to be used in the vicinity of electrosurgical units because such use may interrupt or interfere with the transmission of signals from the telemetry monitor.
- Do not use the telemetry monitor in conjunction with Electro Surgical Unit (ESU).

- **Do not expose the equipment to a Magnetic Resonance (MR) environment.**
 - ◆ Thermal injury and burns may occur due to the metal components of the equipment which can heat during MR scanning.
 - ◆ The equipment may present a risk of projectile injury due to the presence of ferromagnetic materials which can be attracted by the MR magnet core.
 - ◆ The leadwires and electrodes will generate artifacts in the MR image.
 - ◆ The equipment will not function properly due to the strong magnetic and radio frequency fields generated by the MR scanner.
- **Before putting the telemetry monitor into operation, the operator must verify that the equipment, connecting cables and accessories are in correct working order and operating condition.**
- **Do not use patient cables or accessory cables and sensors if prior visual inspection reveals cable damage or the presence of liquid, lint or dust inside.**
- **Do not come into contact with the patient during defibrillation. Otherwise serious injury or death could result.**
- **Do not touch the patient and live parts simultaneously.**
- **Do not open the equipment housings. All servicing and future upgrades must be carried out by trained and authorized personnel.**
- **Do not rely exclusively on the audible alarm system for patient monitoring. Adjustment of alarm volume to a low level may result in a hazard to the patient. Always keep the patient under close surveillance.**
- **The physiological data and alarm messages displayed on the telemetry monitor are for reference only and cannot be directly used for diagnostic interpretation.**
- **PATIENTS WITH A PACEMAKER – On ventricular paced patients, episodes of ventricular tachycardia may not always be detected. Do not rely entirely upon the system’s automated arrhythmia detection algorithm. Keep pacemaker patients under close surveillance.**
- **Do not operate the touch screen with wet hand.**
- **Only use parts and accessories specified in this manual.**
- **Route, wrap and secure the cables to avoid inadvertent disconnection, stumbling and entanglement.**
- **Instruct patients not to interact with the display of the telemetry monitor and not to open the battery compartment while the telemetry monitor is in use.**
- **The telemetry monitor should not be used for primary monitoring in applications where momentary loss of the ECG is unacceptable at the Central Monitoring System.**
- **Do not place the equipment or accessories in any position that might cause it to fall on the patient.**

- Do not start or operate the equipment unless the setup was verified to be correct.
 - If any measurement seems questionable, first check the patient's vital signs by alternate means and then check the pulse oximeter for proper functioning.
 - The equipment should not be used as the sole basis for medical decisions. It must be used in conjunction with clinical signs and symptom.
 - Auditory alarm signal sound pressure levels that are less than ambient levels can impede operator recognition of alarm conditions.
-
-

1.1.2 Cautions

CAUTION

- Do not let the display of the telemetry monitor directly touch the patient's skin when the display is on.
- When the Central Monitoring System (hereinafter called CMS) presents the alarm "Offline", the settings being performed on the telemetry monitor may not be transferred to the CMS. Check the patient condition and the settings on the CMS.
- When disposing of the packaging material, be sure to observe the applicable local waste control regulations and keep it out of children's reach.
- After the configurations, such as the patient category, paced status, are changed at the telemetry monitor, the medical personnel should check those configurations at the CMS to make sure both of the configurations are consistent.
- The patient should be required to move in a specified area. If the patient is at the edge of or outside the network coverage range, unstable network connection may compromise the monitoring performance. The patient's location is of vital importance for the telemetry monitor. If a life-threatening situation occurs for a patient, this patient must be located and found by medical staff immediately.
- Mindray takes no responsibility for controlling the radio frequency environment in a hospital. If interference for the operating frequency of telemetry equipment exists, the telemetry equipment performance will be affected. Exercise caution when selecting the operating frequency of all the wireless equipment in a hospital as this is very important to avoid mutual interference among them.
- Magnetic and electrical fields are capable of interfering with the proper performance of the telemetry monitor. For this reason make sure that all external equipment operated in the vicinity of the telemetry monitor comply with the relevant EMC requirements. Mobile phone, X-ray equipment, microwave oven, interphone, or MRI equipment are a possible source of interference as they may emit higher levels of electromagnetic radiation.





















- **Always install or carry the telemetry monitor properly to avoid damage caused by drop, impact, strong vibration or other mechanical force.**
 - **Dry the telemetry monitor immediately in case of rain or water spray.**
 - **When the patient carrying a telemetry monitor moves in a hospital, signal quality can be impacted on an ambulatory patient by the construction materials used within the hospital.**
 - **At the end of its service life, the telemetry monitor and its accessories must be disposed of in compliance with the guidelines regulating the disposal of such products to prevent bringing potential negative consequences to the environment and human health. If you have any questions concerning disposal of the equipment, please contact Mindray.**
-

1.1.3 Notes

NOTE

- **Put the equipment in a location where you can easily see the screen and access the operating controls.**
 - **In normal use, the operator shall stand in front of the equipment.**
 - **The software was developed in compliance with IEC60601-1-4. The possibility of hazards arising from software errors is minimized.**
 - **This manual describes all features and options. Your equipment may not have all of them.**
 - **Keep this manual in the vicinity of the equipment so that it can be obtained conveniently when needed.**
-

1.2 Equipment Symbols

Symbol	Description	Symbol	Description
	Power On/Off key		Main menu key
	Nurse call key		Symbol for aligning the SpO ₂ connector
	Charge indicator		Alternating current
	DEFIBRILLATION-PROOF TYPE CF APPLIED PART		Serial number
	Date of Manufacture		Manufacturer
	MR Unsafe – do not subject to magnetic resonance imaging (MRI)	IPX7	Protection against fluid ingress
	Non-ionizing radiation		General warning sign
	Refer to instruction manual/booklet		Standby
	Humidity limitation		Atmospheric pressure limitation
	Temperature limitation		Plastics identification symbol
 <p>ETL CLASSIFIED C-UL US Intertek 3179617</p>	<p>The presence of this label indicates the machine was certified by ETL with the statement:</p> <p>Conforms to AAMI Std ES 60601-1, IEC Std 60601-1-6, IEC Std 60601-1-8, IEC Std 60601-2-27, IEC Std 60601-2-49, ISO Std 80601-2-61, IEC Std. 80601-2-30</p> <p>Certified to CSA Std C22.2 NO. 60601-1, NO. 60601-1-6, NO. 60601-1-8, NO.60601-2-27, NO. 60601-2-49, NO.80601-2-61, NO.80601-2-30</p>		

NOTE

- Some symbols may not appear on your equipment.

This page intentionally left blank.

2 General Product Description

2.1 Intended for Use

The TM70 telemetry monitor is intended for use on Adult and Pediatric patients over three years old to monitor ECG, SpO₂, NIBP and Resp physiological data. The physiological data can be analyzed, alarmed, stored, reviewed locally on the display of the monitor, and the CentralStation can config and display the physiological parameters from the TM70. The TM70 telemetry monitor is intended for use in professional healthcare facilities under the direct supervision of a licensed healthcare practitioner.

WARNING

- **Only skilled/trained clinical professionals should operate the equipment.**
 - **The equipment is not designed for monitoring critically ill patients.**
 - **If the accuracy of any value displayed at the Central Monitoring System (hereinafter called CMS) or telemetry monitor is questionable, determine the patient's vital signs by alternative means and verify that the telemetry device is working correctly.**
 - **The telemetry monitor transmits the data through the wireless connection. There might be a risk of data loss.**
-
-

2.2 Applied Parts

The applied parts of the telemetry monitor are:

- ECG leadwires
- SpO₂ cables
- SpO₂ sensors
- NIBP tubes and cuffs

2.3 System Components

The telemetry monitor system mainly consists of the following components:

■ Central Monitoring System (CMS)

The BeneVision Central Monitoring System (CMS) is a networked patient monitoring system intended for use in a fixed location, installed in professional healthcare facilities to provide clinicians remote patient monitoring. It configures and displays the physiological parameters from the telemetry monitor. For details on the CMS, refer to the CMS' operator's manual.

■ AC70

The AC70 is the access point controller, used for AP70 and TM70 management, and event review. For details on the AC70, refer to the telemetry monitor service manual or network deployment guide.

■ SYNC70

SYNC70 is the synchronization unit, used to synchronize time between AP70s and TM70s to reduce wireless interference. For details on the SYNC70, refer to the telemetry monitor service manual or network deployment guide.

■ AP70

The AP70 is the access point, used to bridge the telemetry monitor to the wired network. For details on the AP70, refer to the telemetry monitor service manual or network deployment guide.

■ TM70

The TM70 is the telemetry monitor, used to monitor the patient's ECG, SpO2, NIBP, and Resp physiological data. It relies on the telemetry monitor system to perform normally.

■ BP10

BP10 is the NIBP module, used to measure, display, review, store the NIBP parameter for ambulating adult and pediatric patients, and transfer the information to other devices in this system. For details on the BP10, refer to the user manual of BP10.

The AC70, CMS, and SYNC70 are connected with the AP70 through the wired network. The TM70 is connected with the AP70 through the wireless network.

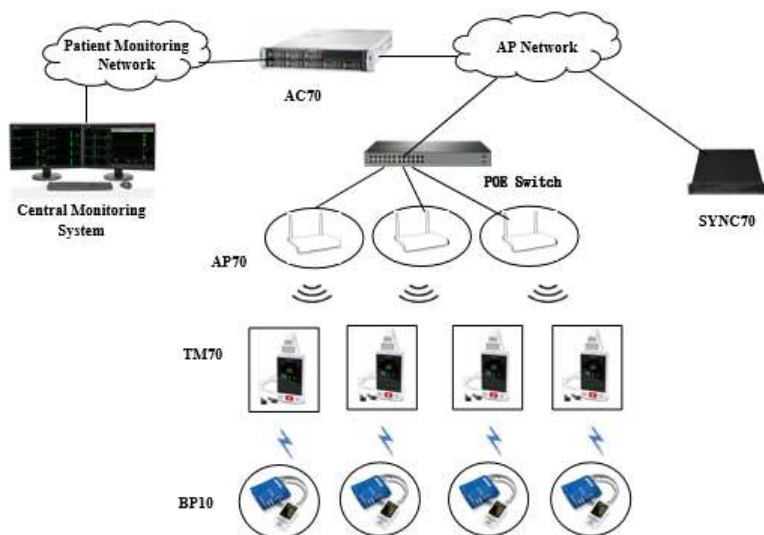

System Components

NOTE

- **For a safer and more stable network, a backup AC70 and a backup SYNC70 are recommended.**

2.4 TM70 Key Features

- 3.5" color PTC touch screen display is easy for clinicians to use.
- Small, portable, and lightweight for patients to wear.
- Supports 3/5/6-lead ECG.
- Supports Masimo SpO₂ module and Nellcor SpO₂ module.
- Communication to the Central Monitoring System (hereinafter abbreviated as CMS) utilizes 608MHz/1.4GHz WMTS frequency .
- Displays the battery status and supports the multiple levels of battery alarms.
- Displays Heart Rate (HR) , Resp, SpO₂, and NIBP parameter numerics and ECG, SpO₂, and Resp waveforms.
- Battery options of three AA batteries or one lithium-ion battery pack are available.
- Display supports parameter auto-sizing.

2.5 TM70 Components

The telemetry monitor consists of the following:

- telemetry monitor main unit
- NIBP module (BP10)
- Central charger
- Accessories

This manual only describes the telemetry monitor main unit (hereinafter called the TM70). For information about the BP10, the central charger, and the central monitoring system, refer to **BP10 NIBP Module Operator's Manual**, **BeneVision Central Charger Operator's Manual**, and **BeneVision Central Monitoring System Operator's Manual** respectively.

2.6 TM70 Physical View

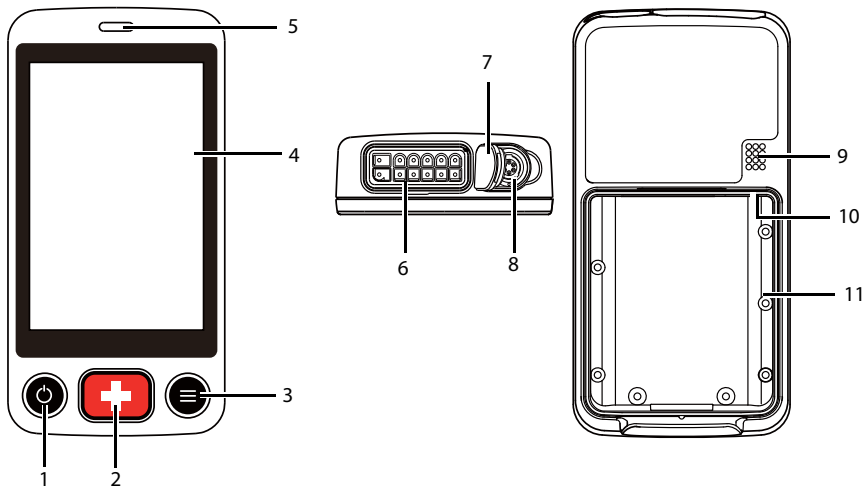

1. Display Activation (Power On/Off) key
 - When the device is powered off, pressing this button will turn it on.
 - When the device is powered on:
 - ◆ And the screen display is on, pressing this key will turn the display off.
 - ◆ And the screen display is off, pressing this key will turn the display on.
 - ◆ Press and hold this key for two seconds to display the power off confirmation menu.
2. Nurse Call key

Pressing this key will send a nurse call request to the CMS. The alarm light/indicator will illuminate cyan, and a "Nurse Call Initiated" message will display in the message area if the display is on.

3. Main Menu key

- ◆ Pressing this key when on the main screen will open the main menu.
- ◆ Pressing this key when a menu is open will return to the main screen.
- ◆ Pressing this key when the display is off will turn the display on.
- ◆ Pressing this key when the screen lock mode is configured for View Only will display the **Screen Locked** menu.

4. Display

The touch screen is the primary user interface for operating the device and viewing information (or patient data).

5. Alarm light/indicator

Flashes in different color and frequency corresponding to the alarm level.

6. ECG connector

Connects the ECG leadset.

7. SpO₂ cap

Covers SpO₂ connector when SpO₂ is not in use.

8. SpO₂ connector

Connects the SpO₂ module.

9. Speaker

10. USB connector

It is only available for authorized service personnel.

11. Battery compartment

Contains the lithium-ion battery pack or AA battery frame.

2.7 TM70 Touch Screen Display

WARNING





- **Do not operate the touch screen with wet hands.**
-
-



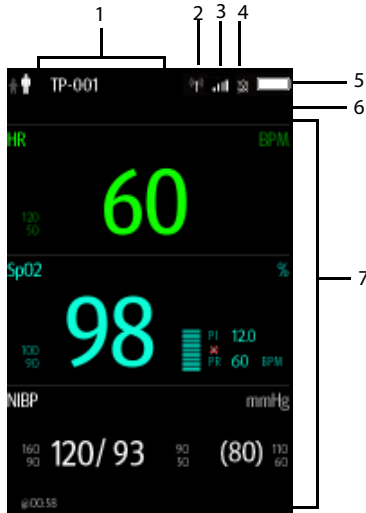



Move your finger on the touch screen display to operate the telemetry monitor. For details about the supported touch gestures, refer to **3.7.1 Understanding the Screen Display Orientation**.

2.7.1 Display Screen

The main screen displays patient parameters and waveforms. A typical display screen is shown below.



1. Patient information area
Tapping this area displays the **Patient Info** menu.
This area shows patient category and other patient information. Priority of other patient information showing in this area is as below:
 - a. Patient name (including first name and last name)
 - b. Patient ID
 - c. Bed number
 - d. Device name
2. Alarm symbol: indicates the status of the alarm system:
 - ◆  : indicates that all the alarms are paused.
 - ◆  : indicates the alarm audio is turned off.
 - ◆  : indicates that the alarm system is reset.
3. Mindray Patient Area Network (herein abbreviated as MPAN) indicator
 - ◆  indicates that the telemetry monitor is not paired with the BP10 or one telemetry monitor is not connected to another telemetry monitor for configuration transfer.

- ◆  indicates that the telemetry monitor is paired with the BP10 successfully or configuration transfer of the telemetry monitors in progress.
4. Wireless symbol
 - ◆  indicates that the telemetry monitor has been connected to the wireless access point and the signal coverage is very good. Stable data transmission via wireless network can be guaranteed.
 - ◆  indicates that the telemetry monitor has been connected to the wireless access point and the signal coverage is good. Stable data transmission via wireless network can be guaranteed.
 - ◆  indicates that the telemetry monitor has been connected to the wireless access point and the signal coverage can basically meet the requirements. Stable data transmission via wireless network can be guaranteed.
 - ◆  indicates that the telemetry monitor has been connected to the wireless access point and the signal coverage is weak. Wireless offline may occur.
 - ◆  indicates that the telemetry monitor has been connected to the wireless access point and the signal coverage is very weak. Wireless offline would occur.
 - ◆  indicates that the telemetry monitor is not connected to the wireless access point.
 5. Battery symbol

This symbol indicates the battery charge status. For details about the battery status symbols, refer to **14.4 Checking the Battery Charge Status**. Tapping the battery symbol opens the **System Info** menu and displays the battery information.
 6. System time
 7. Prompt message area

This area shows physiological alarm messages, technical alarm messages, and informational messages. When there are multiple messages, the messages scroll. Tapping this area displays the **Alarm List** menu where you can view all the alarm messages. The “...” symbol indicates that there are more than one message.
 8. Patient data area

This user configurable area can display parameter/waveform data. The parameter/waveform is labeled in the upper left corner. You may also tap this area to display the setup menu for the corresponding parameter/waveform.

For details about the touch screen operations, refer to **3.7 Basic Operations**.

2.7.2 On-Screen Keyboard

The telemetry monitor uses an on-screen keyboard to enter alphanumeric information, such as the device name and passwords.

2.7.2.1 Alphabetic Keyboard



1. Alphabetic buttons: tap to input the desired alphabetic text.
2. Delete button: tap to erase the text to the left of the cursor.
3. Accept button: tap to save the settings and exit the keyboard.
4. Space button: tap to input a space.
5. Numeric switch button: tap to switch to the numeric layout.
6. Case shift button: tap to switch the case of the letter.
This switch is active for one character entry.

2.7.2.2 Numeric Keyboard

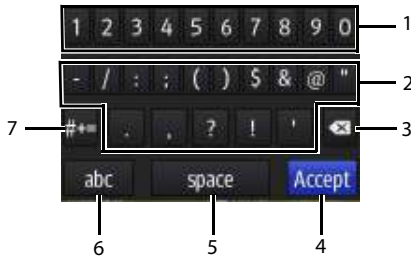

1. Numeric buttons: tap to input the desired numbers.
2. Punctuation buttons: tap to input the desired punctuation mark or symbol.
3. Delete button: tap to erase the text to the left of the cursor.
4. Accept button: tap to save the settings and exit the keyboard.
5. Space button: tap to input a space.
6. Alphabetic switch button: tap to switch to the alphabetic layout.
7. More punctuation buttons: tap to display the punctuation keyboard, as shown below.



This page intentionally left blank.

3 Getting Started

WARNING

- The telemetry monitor shall be installed by Mindray authorized personnel.
 - The software equipment copyright is solely owned by Mindray. No organization or individual shall resort to altering, copying, or exchanging it or to any other infringement on it in any form or by any means without due permission.
 - Connect only approved devices to this system. Devices connected to the equipment must meet the requirements of the applicable IEC standards (e.g. IEC 60950 safety standards for information technology equipment and IEC 60601-1 safety standards for medical electrical equipment). The system configuration must meet the requirements of the IEC 60601-1 medical electrical systems standard. Any personnel who connect devices to the equipment's signal input/output port is responsible for providing evidence that the safety certification of the devices has been performed in accordance to the IEC 60601-1. If you have any questions, please contact Mindray.
 - If it is not evident from the equipment specifications whether a particular combination with other devices is hazardous, for example, due to summation of leakage currents, please consult the manufacturers or else an expert in the field, to ensure the necessary safety of patients and all devices concerned will not be impaired by the proposed combination.
 - Contact Mindray to relocate the telemetry monitor.
 - Only Mindray authorized personnel can update the telemetry monitor.
-
-

CAUTION

- **Many settings in the telemetry monitor are password protected. It is recommended to change the default passwords and keep the passwords safe. Passwords should only be changed by authorized personnel. Contact your department manager or biomedical engineering department for the passwords used at your facility.**
-

3.1 Unpacking and Checking

Before unpacking, examine the packing case carefully for signs of damage. If any damage is detected, contact the carrier or Mindray.

If the packing case is intact, open the package and remove the device and accessories carefully. Check all materials against the packing list and check for any mechanical damage. Contact Mindray in case of any problem.

WARNING

- **The telemetry monitor may be subject to microbacteria contamination during storage, transport, or use. Prior to use, please verify that the packages are intact, especially the packages of single use accessories. In case of any damage, do not apply it to patients.**
-
-

NOTE

- **Save the packing case and packaging material as they can be used if the device must be reshipped.**
-

3.2 Environmental Requirements

The operating environment of the system must meet the requirements specified in this manual.

The equipment operating environment should be reasonably free from noises, vibration, dust, corrosive, flammable and explosive substances.

When the device is moved from one place to another, condensation may occur as a result of temperature or humidity difference. In this case, never start the system before the condensation disappears.

WARNING

- **Make sure that the device operating environment meets the specifications. Otherwise unexpected consequences, e.g. damage to the device, could result.**
-

NOTE

- **The system transmits data through a wireless connection. External radio frequency interference may result in occasionally data dropout. Contact Mindray for any questions regarding the electromagnetic environment.**
-

3.3 Connecting the ECG Leadwire

1. Align the ECG leadwire plug with the ECG connector as indicated by the arrow in the following figure.

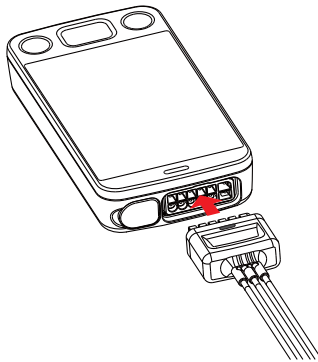

2. Insert the ECG leadwire plug into the ECG connector as shown in the enlarged figure below.

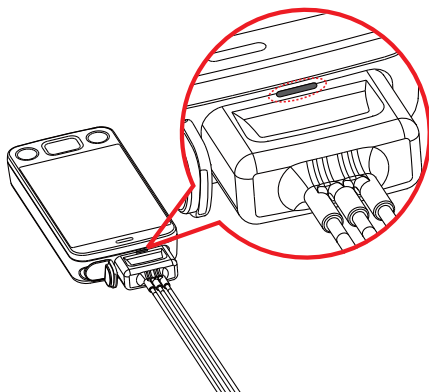

WARNING

- **Insert the ECG lead set into the ECG connector. The following performance may be affected by a weak connection:**
 - ◆ ECG signal quality
 - ◆ Water resistance
 - **Do not use the ECG leadwire to move or lift the telemetry monitor. This may cause the device to fall, which may damage the equipment or injure the patient.**
-

NOTE

- **Insert the SpO₂ cap in the SpO₂ connector when SpO₂ is not in use.**
-

3.4 Installing the Batteries

You can use AA batteries or a lithium-ion rechargeable battery pack to power the TM70.

The runtime is dependent on the battery configuration chosen. A lithium-ion battery pack will provide the longest runtime. For details about the recommended AA batteries, refer to **18.4 Miscellaneous**.

NOTE

- **Always keep the battery compartment dry.**
 - **The lithium-ion battery pack or AA battery tray should be placed in the correct direction and should not be installed in reverse.**
 - **Never use brute force to install the lithium-ion battery pack or AA battery tray. Otherwise the waterproof ring surrounding the battery frame edge may be broken to affect the waterproof performance.**
-

3.4.1 Installing the Lithium-ion Rechargeable Battery Pack

WARNING

- **Only use specified lithium-ion rechargeable batteries. Use of other lithium-ion batteries will adversely affect the batteries: Level reporting; Low battery alarms; Life performance.**
-
-

NOTE

- **The lithium-ion rechargeable battery pack should be fully charged prior to first use.**
-
1. Make sure that the battery compartment is empty.
 2. Align the hook on the upper part of the lithium-ion battery pack with the slot on the battery compartment, as indicated by the enlarged figure below.

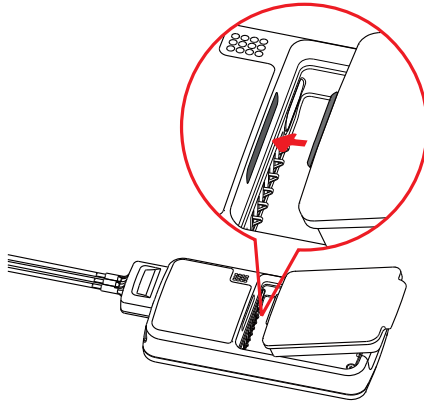

3. Press down the battery pack until it is installed firmly, as indicated by the arrow in the following figure.

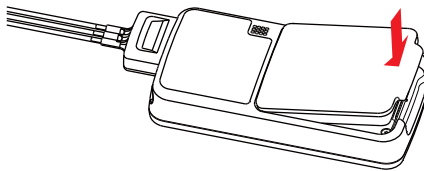

3.4.2 Installing the AA Batteries

To install the AA batteries:

1. Make sure the battery compartment is empty.
2. Insert three 1.5V alkaline AA batteries according to the diagram in the bottom of the battery tray as shown in the images below.

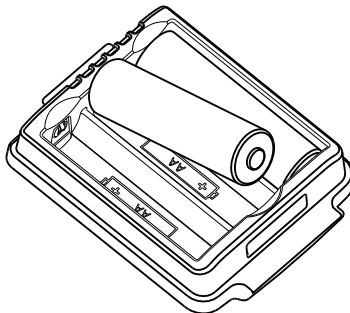

3. Align the hook on the upper part of the battery tray with the slot on the battery compartment, as indicated by the enlarged part in the following figure.

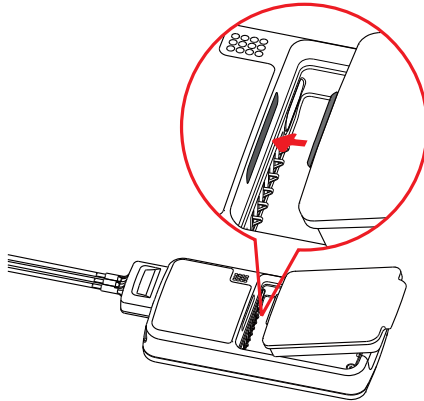

4. Press down the battery tray until it closes firmly, as indicated by the arrow in the following figure:

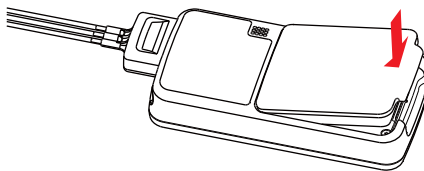

3.5 Powering On the Unit

When the rechargeable lithium-ion pack or AA battery tray is properly installed into the compartment door, the telemetry monitor will be powered on automatically. The alarm light will momentarily illuminate cyan to indicate that the equipment is starting. The telemetry monitor performs a self-test during startup. The alarm light flashes red, yellow, and cyan in turn, and then off. This indicates that the alarm system functions correctly.

When the telemetry monitor installed with the rechargeable lithium-ion pack or AA battery tray is powered off, press the  key to turn it on.

Upon powering up, there are two situations:





- When the telemetry monitor is turned on for the first time, the device will request you to configure first time startup. Please make your desired configurations as prompted.
- When the telemetry monitor is turned on the next time, the device will prompt whether it is a new patient. Select **Yes** or **No** as desired. If the device is in a lock mode, a passcode is required.

WARNING

- **Check that visual and auditory alarm signals are presented correctly when the equipment is powered on. Do not use the equipment for any monitoring procedure on a patient if you suspect the equipment is not working properly or if the equipment is mechanically damaged. Contact your service personnel or Mindray.**
-
-

3.6 Understanding Touch Gestures

Before using the telemetry monitor, understand the supported touch screen gestures:

Gesture	Description
 Tap	Briefly touch the surface with your fingertip to select a target.
 Press and hold	Touch the surface for extended period of time.
 Drag	Move your fingertip over the surface without losing contact.
 Swipe	Quickly brush the surface with your fingertip.

3.7 Basic Operations

This section describes the basic operations for the telemetry monitor.

WARNING

- **Patients should be instructed not to interact with the display of the device and to not open the battery compartment while the telemetry monitor is in use.**
-
-

3.7.1 Understanding the Screen Display Orientation

The telemetry monitor supports both the portrait and landscape display orientations.



Example of portrait display



Example of landscape display

- Portrait: both digital and waveform tiles take up the entire width of the screen.
- Landscape: the digital tile takes up one half of the width of the screen; the waveform tile takes up the entire width of the screen.

3.7.2 Browsing the Screen Display

- To scroll the screen display, drag your finger up or down on the screen.
- To quickly move through the parameters, Swipe your finger up or down on the screen.

3.7.3 Switching the Screen Display Orientation

To switch the screen display orientation, follow this procedure:

1. Swipe your finger down from the top of the main screen to display the following buttons.
 - ◆ : this button is displayed in portrait orientation. It switches portrait display to landscape display counterclockwise.
 - ◆ : this button is displayed in portrait orientation. It switches portrait display to landscape display clockwise.
 - ◆ : this button is displayed in landscape orientation. It switches landscape display inversely.
 - ◆ : this button is displayed in landscape orientation. It switches landscape display to portrait display.
2. Select the desired button.

3.7.4 Displaying the Quick Keys Area

Swipe your finger up from the bottom of the main screen to display the quick keys area.

The following table lists the nine default quick keys:

Quick keys	Description
Discharge Patient	Tap the button to enter the Discharge Patient menu. Refer to 5.6 Discharging the Patient for details.
Change Lead	Tap the button to change the current first ECG lead waveform to the next ECG lead waveform that is available in sequential order. For example, if the current first ECG lead waveform is I lead, tap the button, the I lead waveform is changed to II lead waveform.
Alarm Pause	Tap the button to pause the alarm system. Refer to 6.6 Pausing Alarms for details.
Print	Tap the button to notify the CMS to start real-time print. The "Print Initiated" message displays in the prompt message area.
Mark Event	Tap the button to notify the CMS to save the event to the event database. The "Event Marked" message displays in the prompt message area. The marked event is also saved on the events review page of the telemetry monitor.
Alarm Reset	Tap the button to reset the alarm system. Refer to 6.7 Resetting Alarms for details.
Alarm Limits	Tap this button to enter the Alarm Limits menu. Refer to 6.5 Changing Alarm Settings for details.
Events	Tap this button to enter the event review page. Refer to 11 Review for details.
Monitor Mode/ Telemetry Mode	When a patient moves out of the department area, you need to pay close attention to the patient's status on the patient's side. In this case, tap Monitor Mode . Then, the telemetry monitor's display is always on and alarms are issued locally. If the patient returns to the department area, tap Telemetry Mode .

You can customize the most frequently used functions to the quick keys. For details about setting the quick keys, refer to **12.5 Quick Keys Menu**.

3.7.5 Entering the Main Menu

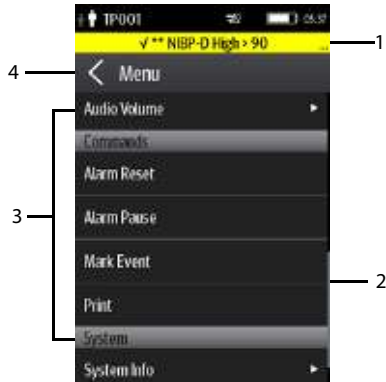

Press the  key to enter the main menu.

The main menu allows access to most of the system functions and settings.



All menus contain the following parts:

1. Heading: displays the current menu title.
2. Scroll bar: drag the bar to scroll the menu.
3. Main body: contains menus, buttons, and other controls to configure and operate the device.

Controls	Description
	Accesses a submenu to reveal more options or information.
	Indicates that a password is required for access.
Submenus	Contains more operations or information related to the corresponding menu.
Buttons	Provides an option to operate a function.
Switch 	Drag to right to enable the switch; drag to left to disable the switch.

4.  exits the current menu and return to the previous menu or the main screen, and saves any modified settings.

3.7.6 Turning the Display Off

You can manually turn the display off, or let the display automatically turn off based on the configured timeout.

- Press the  key to manually turn the display off.
- If the touch screen is not touched for the configured **Display Auto Off** time, then the screen will turn off after the configured **Display Auto Off** time has elapsed.

For details about configuring the time for **Display Auto Off**, refer to **12.3 Configuring the General Menu**.

NOTE

- While the display is off, the telemetry monitor enters the power saving mode, and does not provide audio and visual alarms.
 - If the telemetry monitor is not connected to the CMS or lethal arrhythmia alarm occurs, the telemetry monitor's display is automatically turned on and it will not timeout. You cannot manually turn the display off. For details, refer to **12.10 Auto Enter Monitor Mode**.
-

3.7.7 Turning the Display On



If the screen is off, press the  or  key to turn the display on.

CAUTION

- Do not let the display directly touch the patient when the display is on.
-



3.7.8 Unlocking the Screen in Locked Mode

If you set the screen lock, you need to input the correct passcode to unlock the screen after the display turns off.

1. If the screen is off, press the  or  key to turn the display on and access the **Screen Locked** menu.
2. Input the passcode to unlock the screen.

Once the passcode is entered the screen is temporarily unlocked. If the  is pressed or the device times out, the screen will lock again and a passcode must be entered.

3.7.9 Unlocking the Screen in View Only Mode

1. If the screen is off, press the  or  key to turn the display on.
2. Press the  key to display the **Screen Locked** menu.
3. Input the passcode to unlock the screen.

Once the passcode is entered the screen is temporarily unlocked. If the  is pressed or the device times out, the screen will lock again and a passcode must be entered.

For details about setting the screen lock, refer to **12.7 Screen Lock Menu**.

3.7.10 Acknowledging the Nurse Call

To acknowledge the triggered nurse call, tap **Attendant Present** in the main menu. The “Nurse Call Cancelled” message will display in the message area.

For details about how to trigger a nurse call, refer to **2.8 TM70 Physical View**.

WARNING

- **Do not only rely on the nurse call function, the medical personnel should also pay close attention to the patient’s condition.**
-
-

3.8 Using the Pouch

The telemetry monitor is not intended for direct contact with the patient’s skin. During normal use, the telemetry monitor should be worn over clothing, in a pocket, or in a pouch. The waterproof pouch with a clear window front is an appropriate means for holding the telemetry monitor. Disposable pouches specified in this manual can be used for the telemetry monitor. For details about the pouch, refer to **18.4 Miscellaneous**.

For how to use the pouch for BP10, refer to **BP10 Operator’s Manual**.

CAUTION

- **If a patient needs to take a shower, check the telemetry monitor as described in 17.3 Regular Check before showering, use the specified disposable pouch only, and secure the pouch on the patient as described in this section.**
 - **During showering, do not let water enter or accumulate in the pouch. Besides, do not perform SpO₂ or NIBP measurement.**
 - **When the patient is showering, signal quality and leads off detection may be compromised due to significant movement. Appropriate clinical precautions must be taken.**
-
-

3.8.1 Securing the Pouch for the Telemetry Monitor

To secure the pouch:

1. Place the telemetry monitor into the pouch with the ECG leadwires and the SpO₂ sensor cable, if used, exiting from the pouch opening, as shown in the following figures.

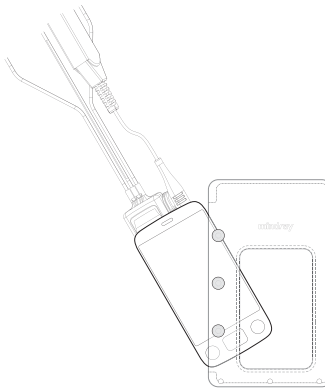

For disposable pouch

2. Pinch the snap-fastener to close the pouch.
3. Secure the pouch on the patient with ties around the patient's shoulder and under the arm, as shown in the following figure.

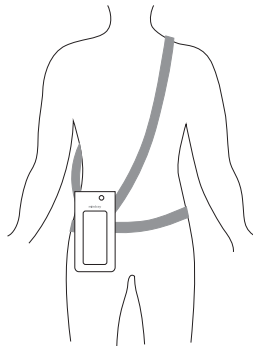

Wearing the disposable pouch

WARNING

- **While using a pouch with the telemetry monitor on the patient, consider the patient's condition. Be careful about the placement of the straps, as the straps could present a strangulation hazard.**
-
-

NOTE

- **The pouch is used only for the telemetry monitor. The pouch cannot be used for carrying other personal devices, such as a mobile phone.**
-

3.8.2 Securing Pouches for the Telemetry Monitor and BP10

When a patient wears the pouches for the telemetry monitor and BP10 simultaneously, follow steps in **3.8.1 Securing the Pouch for the Telemetry Monitor** to secure the pouch for the telemetry monitor on the left or right side of the patient's body and follow steps in **BP10 Operator's Manual** to secure the pouch for the BP10 on the right or left side of the patient's body, as shown in the following figures.

NOTE

- **Do not secure the pouches for the telemetry monitor and BP10 on the same side of the patient's body.**
-

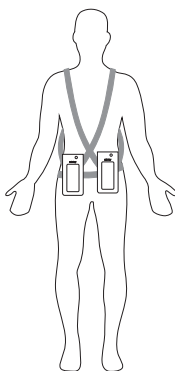

Wearing the disposable pouches

This page intentionally left blank.

4 User Configurations

4.1 Introduction

This chapter gives you an overview of basic operations related to the telemetry monitor, such as configuring the Display Setup, and Audio Volume.

4.2 Configuring the Display

You can configure the display by setting the display layout, display orientation, and screen brightness.

In the main menu, tap **Display Setup** to enter the **Display Setup** menu.

4.2.1 Setting the Default Display Orientation

For details about the display orientation, refer to **3.7.1 Understanding the Screen Display Orientation**.

1. In the **Setup** section of the **Display Setup** menu, tap **Default Orientation**.
Two buttons display: **Portrait** and **Landscape**.
2. Tap a button to set the default orientation.
The selected orientation displays to the right of **Default Orientation**.
3. Restart the telemetry monitor to apply the setting.

NOTE



- **The telemetry monitor must be restarted for the default display orientation selected to be effective.**
-

4.2.2 Understanding Portrait Orientation Display Rules

In portrait orientation, both digital and waveform areas take up the entire width of the screen. Therefore, these parameters will be displayed in the exact order of the **Display Setup** menu, provided the sensor is attached and monitoring data.

4.2.3 Setting the Portrait Display

1. In the **Portrait** section of the **Display Setup** menu, tap **Rows**.
Three options display: **2**, **3**, and **4**.
2. Tap an option to set the row numbers.
The selected option displays to the right of **Rows**.



3. Tap **Portrait Order** to enter the **Portrait Order** menu.
4. Tap a parameter or waveform to select it.
The  icon displays to the right of the selected parameter or waveform.
5. Drag the selected parameter or waveform to the desired position, and then release it.
6. Repeat steps 4 and 5 until the desired order is configured.
7. Tap the  icon to exit the **Portrait Order** menu.

4.2.4 Understanding Landscape Orientation Display Rules

In landscape orientation, waveform areas take up the entire width of the screen. Digital areas only take up one half of the width of the screen. The following rules define how the tiles will be laid out:

1. The areas shall be displayed in the order of the **Display Setup** menu except the digital area locations shall be optimized to reduce blank tiles.
2. A waveform area always takes up the entire width of the screen.
3. A digital area always takes up one half of the width of the screen. Therefore, a row with a digital tile in it shall be split into two half tiles.
4. A digital area shall not be the only parameter in a row unless an odd number of digital areas exist. In this case, the last digital parameter area shall have one tile on the left side and the right half will be blank.
5. Digital areas shall be paired with the next available digital area to satisfy rule 4. This means that a digital area may be moved ahead of a waveform area if a half of a row needs to be filled.

4.2.5 Setting the Landscape Display

1. In the **Landscape** section of the **Display Setup** menu, tap **Rows**.
Three options display: **2**, **3**, and **4**.
2. Tap an option to set the row numbers.
The selected option displays to the right of **Rows**.
3. Tap **Landscape Order** to enter the **Landscape Order** menu.
4. Tap a parameter or waveform option to select it.
The  icon displays to the right side of the selected parameter or waveform.
5. Drag the selected parameter or waveform to the desired position, and then release it.
6. Repeat steps 4 and 5 until the desired order is configured.
7. Tap the  icon to exit the **Landscape Order** menu.

4.2.6 Setting the Display Brightness

1. In the **Setup** section of the **Display Setup** menu, tap **Display Brightness**.
The **Display Brightness** menu displays.
2. Drag the slider to left or right to adjust the brightness.
3. Tap the  icon to exit the **Display Brightness** menu.



4.3 Configuring the Audio Volume

You can independently set the alarm volume, touch screen click volume, and systole beep volume. The method for setting the three volumes is the same.

To change the volume settings:

1. In the main menu, tap **Audio Volume**.
2. In the **Sounds**, **Touch Screen Click**, or **Systole Beep** section, drag the slider to the left or right to decrease or increase the volume.
3. Tap the  icon to exit the **Audio Volume** menu.
The audio volume of alarms ranges from 45 dB to 85 dB.

NOTE

- The  icon indicates that the audio volume is turned off.
 - The minimum sound volume cannot be lower than the minimum alarm volume. Refer to *12.4 Configuring the Alarms Menu* for details.
 - When Minimum Alarm Volume is set to Off and Sounds is turned off, the  icon is displayed on the main screen. It indicates that the alarm sound is turned off.
 - When your telemetry monitor is connected to the CMS and Sounds is turned off, Sounds automatically changes to 2 if the CMS is disconnected.
-

This page intentionally left blank.

5 Patient Management

5.1 Introduction

The chapter describes how to admit a patient, change patient information, enter and exit the Standby mode, and discharge the patient at the telemetry monitor.

5.2 Admitting a Patient

After discharging the current patient, you can admit a new patient by pressing the  key. For how to discharge a patient, refer to **5.6 Discharging the Patient**. After admitting a patient, please check the patient category and make changes appropriately.

5.3 Changing Patient Information

You can change last name, first name and patient ID, patient category, paced status, department name, room number, and bed number.

5.3.1 Changing Last Name, First Name and Patient ID

To change the last name, first name and patient ID, follow this procedure:

1. In the main menu, tap **Patient Info**.
2. In the **Patient Info** menu, tap **Last Name, First Name** or **Patient ID**.
3. Enter the desired contents.

5.3.2 Changing the Patient Category

NOTE

- **Select a correct patient category according to the patient's condition before monitoring begins.**
-

To change the patient category, follow this procedure:

4. In the main menu, tap **Patient Info**.
5. In the **Patient Info** menu, tap **Patient Category**.
6. Select the desired option.
The "Are you sure you want to change the patient category?" message displays.
7. Select **Yes** to confirm the change.
The selected patient category displays to the right of **Patient Category**.



NOTE

- **When the telemetry monitor is connected to the CMS, the patient category at the CMS is updated if the patient category is changed at the telemetry monitor. Refer to *BeneVision Central Monitoring System Operator's Manual* for details.**
-

5.3.3 Changing the Paced Status

It is important to correctly set the patient's paced status before patient monitoring.

To change paced status, follow this procedure:

1. In the main menu, tap **Patient Info**.
2. Check if **Paced** is appropriate for the patient.
3. If the paced status setting is not correct, tap **Paced** and select the correct option.
 - ◆ When **Paced** is set to **Yes** at the telemetry monitor, if pace pulses are detected, the  symbol displays in the waveform area of the Central Monitoring System's screen, and the pace pulse marks will display on the ECG waveform both at the telemetry monitor and Central Station.
 - ◆ When **Paced** is set to **No** or not specified at the telemetry monitor, the  symbol displays in the waveform area of the Central Monitoring System's screen.

WARNING

- **For paced patients, you must set Paced to Yes. If it is incorrectly set to No, the Central Station could mistake a pace pulse for a QRS and fail to alarm when the ECG signal is too weak.**
- **On ventricular paced patients, episodes of ventricular tachycardia may not always be detected.**
- **Do not rely entirely upon the system's automated arrhythmia detection algorithm. Keep paced patients under close surveillance.**
- **For non-paced patients, you must set Paced to No. The pacer pulses may be counted as QRS complexes, hence leading to wrong HR readings or failure to diagnose certain arrhythmia symptoms. Be sure to keep a close eye on patient's with pacemaker devices.**
- **The radio frequency energy of the telemetry monitor or other radio frequency sources, when used in close proximity to a pacemaker, may interfere with pacemaker performance. Internal pacemakers are less vulnerable than external pacemakers due to the shielding effects of the body. However, caution should be exercised when monitoring any paced patient.**

- In order to minimize the possibility of interference, place electrodes, leadwires and telemetry monitors as far away from the pacemaker as possible.
-
-

NOTE

- When Paced is set to Yes and regular pace pulses are available, the system does not detect PVC-related arrhythmia (including PVCs) resulting from pacemaker but still analyzes the normal QRS complex.
-

You can also change the patient's paced status from the **ECG** menu. For information about how to set paced status in the **ECG** menu, refer to **7.3.6 Checking the Paced Status**.

5.3.4 Changing the Department Name, Room Number, and Bed Number

When **Department** and **Bed No./Room No.** are set to **Unfixed** in the **Maintenance** menu, you can change a department name, room number, and bed number in the **Patient Info** menu.

For information about settings in the **Maintenance** menu, refer to **12.3.1 Configuring Device Location**.

To change department name, room number, and bed number:

1. In the main menu, tap **Patient Info**.
2. Tap **Department, Room No.,** or **Bed No.**
3. Enter the desired contents.

NOTE

- When **Department** and **Bed No./Room No.** are set to **Fixed**, the department name, room number, and bed number of the telemetry monitor cannot be changed at the CMS.
-

5.4 Entering the Standby Mode

NOTE

- After a telemetry monitor is connected to the CMS, when it enters or exits Standby mode, the CMS is also notified to enter or exit Standby mode. Refer to *BeneVision Central Monitoring System Operator's Manual* for details.
-

To enter the Standby mode:

1. In the main menu, tap **Standby**.
2. In the **Standby** confirmation menu, select **Yes**.

When a telemetry monitor enters the Standby mode:

- Patient monitoring is suspended.
- Alarm system is suspended.
- Patient data is not displayed on the screen but **“Standby”** is displayed on the screen.
- The screen display automatically turns off after the device enters the Standby mode for 30 seconds.
- The Central Station is notified.

5.5 Exiting the Standby Mode

Press the  key to exit the standby mode.

After exiting the Standby mode, the system responds as follows:

- Restores parameter measurement as previously configured.
- Alarm system is activated.
- Notifies the CMS of returning to normal monitoring.

5.6 Discharging the Patient

Discharging the patient will stop monitoring at the telemetry monitor and CMS. After discharging the patient, the patient’s configuration is cleared at the telemetry monitor. The telemetry monitor can admit next new patient by applying the user configuration. If the telemetry monitor does not save the user configuration, it will apply the factory configuration for the new patient.

You can discharge the patient by selecting the **Discharge Patient** menu or restarting the telemetry monitor.

NOTE

-
- **When the telemetry monitor is connected to a CMS, the patient being discharged from the telemetry monitor is also discharged from the CMS. Refer to *BeneVision Central Monitoring System Operator’s Manual* for details.**
-

5.6.1 Selecting the Discharge Patient Menu

To discharge a patient via the **Discharge Patient** menu, follow this procedure:

1. Enter the **Discharge Patient** menu in either of the following ways:
 - ◆ Swipe your finger up at the bottom of the main screen to display the quick keys area → tap **Discharge Patient**.
 - ◆ Press the  key to enter the main menu → tap **Discharge Patient**.
2. In the **Discharge Patient** confirmation menu, tap **Yes**.
 - ◆ The patient is discharged from both the telemetry monitor and the CMS.

- ◆ The patient's configuration is cleared and the default departmental settings are restored.
- ◆ The **Discharged Patients** window of the CMS adds a record of the patient's history data.

5.6.2 Restarting the Telemetry Monitor

To restart the telemetry monitor, follow this procedure:

1. If the telemetry monitor is powered off, press the  key to turn on the telemetry monitor.
The device prompts whether this is a new patient or not.
2. Select **Yes** if this is a new patient.
3. Select **Yes** when asked to confirm that the discharge should begin.

This page intentionally left blank.

6 Alarms

6.1 Introduction

This chapter describes alarm functions and alarm settings.

6.2 Alarm Safety Information

WARNING

- A potential hazard can exist if different alarm presets and default configuration settings are used for the same or similar equipment in the same care area.
 - If the telemetry monitor is connected to the CMS, alarms can be presented and controlled at the CMS. Remote suspension or reset of alarms at the CMS may cause a potential hazard. For more information, refer to *BeneVision Central Monitoring System Operator's Manual*.
 - The telemetry monitor telemetry monitors in the care area may each have different alarm settings to suit different patients. Always check that the alarm settings are appropriate for your patient before starting monitoring. Always make sure that necessary alarm limits are active and set according to the patient's clinical condition.
 - Setting alarm limits to extreme values may cause the alarm system to become ineffective. For example, setting the SpO₂ high alarm limit to 100%, is equivalent to switching the alarm off.
 - When the alarm sound is switched off, the telemetry monitor gives no alarm tones even if a new alarm occurs. Be careful when considering to switch off the alarm sound. When the alarms are off, observe the patient frequently.
 - When monitoring patients that are not continuously attended by a clinical operator, properly configure the alarm system and adjust alarm settings as per the patient's condition.
 - Do not rely exclusively on the audible alarm system for monitoring. Adjustment of alarm volume to a low level may result in a hazard to the patient.
 - The reception failure of alarm signals may occur in the distributed alarm system.
-

6.3 Understanding the Alarms

6.3.1 Alarm Categories

The telemetry monitor's alarms can be classified into two categories: physiological alarms and technical alarms

- Physiological alarms, also called patient status alarms, are triggered by a monitored parameter value that violates set alarm limits or an abnormal patient condition.
- Technical alarms, also called system status alarms, are triggered by a device malfunction or a patient data distortion due to improper operation or mechanical problems.

Apart from the physiological and technical alarm messages, the telemetry monitor will show some messages telling the system status in the prompt message area of the main screen.

6.3.2 Alarm Priorities

Alarms can be classified into the following severity levels:

- High priority alarms: indicates a life threatening situation or a severe device malfunction. High priority alarms require an immediate response.
- Medium priority alarms: indicates abnormal vital signs or a device malfunction. Medium priority alarms require a timely response.
- Low priority alarms: indicate a discomfort condition, a device malfunction, or an improper operation. Low priority alarms require you to be aware of this condition.
- Messages: provides additional information on the patient or the equipment.

6.3.3 Alarm Indicators

When an alarm occurs, the telemetry monitor indicates it through visual or audible alarm indications. For more information, see the following table.

Alarm Indicator	High Priority Alarm	Medium Priority Alarm	Low Priority Alarm	Message	Comments
Alarm lamp	Red Flashing frequency: 1.4Hz - 2.8 Hz Duty cycle: 20%-60%	Yellow Flashing frequency: 0.4Hz-0.8 Hz Duty cycle: 20% -60%	Cyan No flashing Duty cycle: 100% on	None	None



Alarm Indicator		High Priority Alarm	Medium Priority Alarm	Low Priority Alarm	Message	Comments
Audible tone pattern	ISO	Repeat pattern of triple +double+ triple +double beeps	Repeat pattern of triple beeps	Single beep	None	None
	Mode 1	Repeat pattern of high pitched single beep	Repeat pattern of double beeps	Low-pitched single - beep tone	None	
	Mode 2	Repeat pattern of high pitched triple beeps	Repeat pattern of double beeps	Low-pitched single beep	None	
Alarm message		White text inside a red box	Black text inside a yellow box	Black text inside a cyan box	White text	Alarm messages are displayed in the prompt message area at the top of the screen. You can select the alarm messages to show the alarm list.
Alarm priority indicator		***	**	*	None	The indicator appears in front of the corresponding alarm message.
Parameter value		White text inside a flashing red box	Black text inside a flashing yellow box	Black text inside a flashing cyan box	None	None

NOTE

- When multiple alarms of different priority levels occur simultaneously, the telemetry monitor selects the highest priority alarm to light the alarm lamp and issue the alarm tone,
 - When multiple alarms of different priority levels occur simultaneously, the telemetry monitor only displays the messages from the highest priority alarm.
 - When multiple alarms of the same priority levels occur simultaneously, all the alarm messages are displayed cyclically.
 - Some physiological alarms, such as Asystole, are exclusive. They have identical alarm tones and alarm lights with normal high level physiological alarms, but their alarm messages are displayed exclusively. That is, when an exclusive physiological alarm and a normal high level physiological alarm are triggered simultaneously, only exclusive physiological alarm message will be displayed.
-

6.3.4 Alarm Status Symbols

Apart from the alarm indicators as described in **6.3.3 Alarm Indicators**. The telemetry monitor uses the following symbols to indicate the alarm status:

- : indicates that all the alarms are paused.
- : indicates the alarm audio is turned off.
- : indicates that the alarm system is reset.

6.4 Viewing Alarms

If the telemetry monitor has more than one alarm, you can view all the active alarms in the **Alarm List** dialog.

To view alarms, follow this procedure:



1. Tap the prompt message area on the main screen. The **Alarm List** dialog is displayed.
2. In the **Physiological Alarms** section, you can view the number of physiological alarms and alarm messages.
3. Tap the desired physiological alarm to enter the event review page where you can view the alarm details.
4. In the **Technical Alarms** section, you can view the number of technical alarms and alarm messages.

6.5 Changing Alarm Settings

You can change alarm properties for parameters collectively or individually.

To change alarm properties, follow this procedure:

1. Enter the **Alarm Limit** menu in either of the following ways:

- ◆ Press the  key to enter the main menu → tap **Alarms** → tap **Alarm Limits**.
 - ◆ Tap the desired digital area or waveform area to enter corresponding parameter setup menu → from the **Alarms** section select the alarm setup option.
2. In the **Alarm Limits** section, switch on or off a parameter alarm.
 3. Tap the desired parameter to enter its alarm setup menu.
 4. In the **Limits** section, tap the alarm limit which you want to change.
 5. Enter the new alarm limit.
 6. Tap the  icon to return to the parameter alarm setup menu.
 7. In the **Priority** section, set the desired alarm priority.

NOTE

- **Any changes to the alarm properties on the telemetry monitor will change alarms on the CMS and vice versa if configured.**
-

6.5.1 Changing the Alarm Volume

For information on changing the alarm volume, refer to **4.3 Configuring the Audio Volume**.

6.5.2 Initiating Auto Alarm Limits

The telemetry monitor provides the auto alarm limits function to automatically adjust alarm limits according to the patient's vital signs used. When auto limits are selected, the telemetry monitor calculates safe auto limits based on the latest measured values. To get accurate auto alarm limits, you need to collect a set of measured vital signs as a baseline.

To initiate auto alarm limits, follow this procedure:

1. In the main menu, tap **Alarms**.
2. Tap **Alarm Limits**.
3. In the **Setup** section, tap **Auto Limits**.
4. In the dialog that pops up, tap **OK**.

Then the telemetry monitor will automatically calculate alarm limits based on the latest measured values. Before applying these automatically created alarm limits, confirm if they are appropriate for your patient from the Limits menu. If not, you can adjust them manually. These alarm limits will remain unchanged until you select auto limits again or adjust them manually.

The telemetry monitor calculates auto limits basing on the following rules:

Module	Parameter	Low Limit	High Limit	Auto Limit Range
		Adult/Pediatric	Adult/Pediatric	
ECG	HR/PR (bpm)	(HR/PR×0.8) or 40 (whichever is greater)	(HR/PR×1.25) or 240 (whichever is smaller)	Adult/pediatric: 35 to 240
Resp	RR (rpm)	(RR×0.5) or 6 (whichever is greater)	(RR×1.5) or 30(whichever is smaller)	Adult/pediatric: 6 to 55
SpO ₂	SpO ₂ (%)	Same as the default alarm limit	Same as the default alarm limit	Same as the measurement range
NIBP	NIBP-S (mmHg)	(SYS×0.68 + 10)	SYS×0.86 + 38	Adult: 45 to 270 Pediatric: 45 to 185
	NIBP-D (mmHg)	(Dia×0.68 + 6)	(Dia×0.86 + 32)	Adult: 25 to 225 Pediatric: 25 to 150
	NIBP-M (mmHg)	(Mean×0.68 + 8)	Mean×0.86 + 35	Adult: 30 to 245 Pediatric: 30 to 180

6.5.3 Restoring Default Alarm Settings

To restore default alarm settings, follow this procedure:

1. In the main menu, tap **Alarms**.
2. Tap **Alarm Limits**.
3. In the **Setup** section, tap **Defaults**.
4. In the dialog that pops up, tap **OK**.

6.6 Pausing Alarms

When an alarm occurs, follow this procedure to pause the alarm system.

1. Press the  key to enter the main menu.
2. In the **Commands** section, tap **Alarm Pause**.

OR

1. Swipe your finger up at the bottom of the main screen to display the quick keys area.
2. Tap **Alarm Pause**.

When alarms are paused, the following indicators are given:

- No physiological alarm will be presented within the alarm pause time.

- For technical alarms, alarm sounds are paused, but alarm lamps and alarm messages continue to be presented.
- The remaining alarm pause time is displayed in the prompt message area.
- The alarm pause symbol  is displayed in the upper right corner of the main screen.

The alarm pause time is two minutes by default. You can change the alarm pause time at the CMS. For details, refer to *BeneVision Central Monitoring System Operator's Manual*.

When the pause time expires, the alarm paused status is automatically deactivated.

NOTE

- **When the telemetry monitor is connected to the CMS and the function of remotely pausing alarms is enabled at the CMS, alarms can be paused either at the telemetry monitor or at the CMS. For information on pausing alarms at the CMS, refer to *BeneVision Central Monitoring System Operator's Manual*.**
-

6.7 Resetting Alarms

You can acknowledge the on-going alarms by resetting alarms. After being reset, the alarm system can respond to a subsequent alarm condition.

When an alarm occurs, follow this procedure to reset the telemetry monitor's alarm system.

1. Press the  key to enter the main menu.
2. In the **Commands** section, tap **Alarm Reset**.

Or

1. Swipe your finger up at the bottom of the main screen to display the quick keys area.
2. Tap **Alarm Reset**.

NOTE

- **When the telemetry monitor is connected to the CMS and the function of remotely resetting alarms is enabled at the CMS, alarms can be reset either at the telemetry monitor or at the CMS. For information on resetting alarms at the CMS, refer to *BeneVision Central Monitoring System Operator's Manual*.**
-

6.7.1 Resetting Physiological Alarms

After the alarm system is reset, physiological alarms give the following alarm indicators:

- The alarm sound is silenced.
- The  symbol is displayed in the upper right corner of the main screen.

- A ✓ mark appears before the alarm message.
- The color of the parameter numeric background corresponds with the alarm priority, but the parameter numeric does not flash.

6.7.2 Resetting Technical Alarms

After the alarm system is reset, technical alarms give the following alarm indicators:

- Some technical alarms are cleared and no alarm indications are given.
- Some technical alarms are changed to prompt messages.
- For some technical alarms, the alarm sound will be silenced, the alarm light will continue to indicate the alarm, a ✓ mark will appear before the alarm message.
- For some technical alarms, the  symbol is displayed in the upper right corner of the main screen.

For details about the indications of technical alarms when the alarm system is reset, refer to **15.3 Technical Alarm Messages at the Telemetry Monitor**.

NOTE

- **If an operator disconnects an SpO₂ sensor or a module purposefully, resetting alarms can turn off alarm indicators for the technical alarms triggered by this action.**
-

6.8 Latching Alarms

When physiological alarms are latched, the time when the alarm is last triggered is displayed behind the alarm message. Resetting or pausing alarms via the telemetry monitor or the CMS clears latched alarms.

NOTE

- **Latching settings for physiological alarms are configured at the CMS. For more information on how to configure latching settings, refer to *BeneVision Central Monitoring System Operator's Manual*.**
-

6.9 Actions When an Alarm Occurs

When an alarm occurs, observe the following steps and take proper actions:

1. Check the patient's condition.
2. Confirm the alarming parameter or alarm category.
3. Identify the source of the alarm.
4. Take proper action to eliminate the alarm condition.

5. Make sure the alarm condition is corrected.

For more information, refer to **15 Troubleshooting**.

This page intentionally left blank.

7 Monitoring ECG, Arrhythmia, ST and QT

7.1 Introduction

The electrocardiogram (ECG) measures the electrical activity of the heart and displays it on the telemetry monitor as waveforms and numerics.

ECG monitoring provides 3-lead, 5-lead, and 6-lead ECG monitoring, ST-segment analysis, arrhythmia analysis, and QT/QTc measurements.

Operations such as configuring the QRS threshold, adjusting the ST point/ISO point/J point, configuring the ST template/QT template are performed at the CMS. For details about these operations, refer to **13 Monitoring with the Telemetry Monitor at the CMS**.

7.2 ECG Safety Information

WARNING

- **The telemetry monitor is not suitable for direct cardiac application.**
 - **Use manufacturer specified electrodes and lead wires.**
 - **Make sure the conductive parts of electrodes and associated connectors for applied parts, including the neutral electrode, do not contact any other conductive parts including earth.**
 - **Periodically inspect the electrode application site to ensure skin quality. If the skin quality changes, replace the electrodes or change the application site.**
 - **Do not touch the patient or any device connected to the patient, including the bed and gurney, during defibrillation. Otherwise serious injury or death could result.**
 - **False low heart rate indicators or false Asystole calls may result with certain pacemakers because of pacemaker artifact such as electrical overshoot of the pacemaker overlapping the true QRS complexes.**
-
-

7.3 Preparation for Monitoring ECG

CAUTION

- **Interference from a non-grounded instrument near the patient and electro-surgery interference can cause problems with the waveform.**
-
-

NOTE

- **After defibrillation, the waveform recovers within 10 seconds applied in accordance with the manufacturer's instructions for use.**
-

7.3.1 Preparing the Patient's Skin

Proper skin preparation is essential in obtaining an accurate ECG reading. Electrode sites should be clean and dry and should provide a smooth flat surface. Incidental electrical activity and inaccurate readings may arise from incorrect skin preparation.

The following procedure is recommended for secure electrode application:

1. Shave the chest hair from the electrode sites in a circular area with a diameter of 2 to 4 inches.
2. Use a dry gauze pad to remove excess skin oils, skin cells and residue from the electrode sites. Never rub the skin until it is raw or bleeding.

NOTE

- **Prepare the electrode site with alcohol only if the skin is extremely greasy. If alcohol is used as a drying agent, always allow the skin to dry before placing the electrode on the skin.**
-

7.3.2 Positioning the Electrodes

NOTE

- **Store electrodes at room temperature and open just prior to use.**
 - **Avoid more than one type of electrode on a patient because of variations in electrical resistance.**
 - **Give special attention to the type of electrode used. Because some electrodes may generate greater electric offset due to polarization.**
 - **Do not use electrodes of different metallic materials.**
 - **Avoid placing electrodes directly over bone prominences or over any high activity movement areas such as shoulders or arms because muscle motion produces electrical activity. If an electrode is placed over a large muscle such as the pectorals, the device may detect this additional muscle activity and could lead to false arrhythmia calls.**
 - **Using a Transcutaneous Electrical Nerve Stimulator (TENS): since A tens UNIT transmits electrical impulses, avoid placing ECG electrode near the TENS electrodes. ECG electrodes may need to be repositioned and the ECG lead viewed may need to be adjusted until the optimum ECG tracing is obtained.**
-

To position the electrodes, follow this procedure:

1. Peel the backing off of the electrode. Visually inspect the contact gel medium for moistness. If the gel medium is not moist, do not use the electrode patch. Dry electrode patches are not conductive.

NOTE

- **To prevent evaporation of the contact gel medium, peel the backing off of the electrode patch only when it is ready for use.**
 - **If using the snap type lead wires, attach the electrode to the lead wire before placing the electrode on the patient.**
-
2. Attach the electrode patch to the skin at the prepared site. Smooth the electrode patch down in a circular motion to ensure proper skin contact. If using soft gel electrodes, never push down directly over the contact gel medium as this may displace the gel and cause monitoring artifact. If using hard gel electrodes, it is recommended that during application, the center of the electrode should be slightly pressed onto the skin to ensure direct contact. Consult the electrode manufacturer's instructions for specific use. Ensure all the electrodes are applied to the patient properly.
 3. Secure the lead wires to the patient according to hospital practice.

CAUTION

- **Route leadwires neatly. Ensure leadwires are kept away from patient's neck to avoid strangulation. Keep floors and walkways free of cables to reduce risk to hospital personnel, patients and visitors.**
-

NOTE

- **It is recommended that the electrodes be changed at least every 24 to 36 hours to maintain proper contact with the skin, although some patients may require more frequent changing. Do not reapply disposable electrode. Try to avoid reusing the exact same electrode site during reapplication. If an electrode becomes wet with fluid, change the electrode.**
-

7.3.3 Configuring the ECG Lead Labeling

7.3.3.1 Lead Naming Standards

This manual presents lead placement according to the guidelines of the American Heart Association (AHA) and the International Electro-Technical Commission (IEC).

Lead position	AHA		IEC	
	Label	Color	Label	Color
Chest	V	Brown	C	White
Left Leg	LL	Red	F	Green
Right Leg	RL	Green	N	Black
Left Arm	LA	Black	L	Yellow
Right Arm	RA	White	R	Red

7.3.3.2 Configuring the ECG Lead Labeling and Cable Type

To configure the ECG lead labeling and cable type, follow this procedure:

1. Press the  key to enter the main menu.
2. Tap **Maintenance**, enter the passcode, and then tap **Accept**.
3. Tap **General**.
4. Tap **ECG Lead Labeling** and set it to **AHA** or **IEC**.
5. Tap any area in the ECG waveform or parameter area to call up the **ECG** menu.
6. Set **Cable Type** to **3 Lead**, **5 Lead**, **6 Lead**, or **Auto** according to your requirement.

7.3.4 Placing the Electrodes

For lead placement, the ECG algorithm works best when the patient's R wave is significantly larger than the P wave or the T wave. If the R wave is not significantly larger than other lower voltage waves on the ECG tracing, the telemetry monitor may have some difficulty in identifying the appropriate waves. For some patients, you need to adjust electrode placement and/or the viewed ECG lead to obtain a significant R wave.

7.3.4.1 Standard 3-Leadwire Electrode Placement

A 3-wire lead set can monitor one of three ECG vectors (I, II, or III). The recommended 3-wire lead placement is as follows:

AHA	IEC	Electrode Placement
RA (white)	R (red)	At the patient's 2nd ICS midclavicular line to the right of the sternum.
LA (black)	L (yellow)	At the patient's 2nd ICS midclavicular line to the left of the sternum.
LL (red)	F (green)	On the patient's lower left chest wall within the ribcage frame.

7.3.4.2 Standard 5-Leadwire Electrode Placement

A 5-wire lead set can monitor seven ECG vectors (I, II, III, aVR, aVL, aVF, and V) simultaneously. The recommended 5-wire lead placement is as follows:

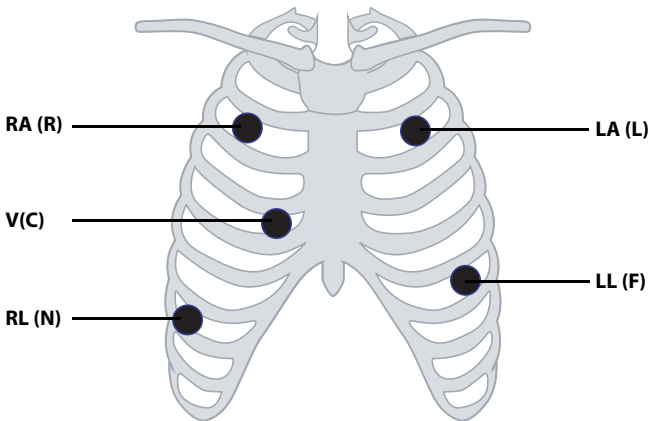

AHA	IEC	Electrode Placement
RA (white)	R (red)	At the patient's 2nd ICS midclavicular line to the right of the sternum.
LA (black)	L (yellow)	At the patient's 2nd ICS midclavicular line to the left of the sternum.
LL (red)	F (green)	On the patient's lower left chest wall within the ribcage frame.
RL (green)	N (black)	On the patient's lower right abdomen within the ribcage frame.
V (brown)	C (white)	V-lead (C-lead) position depicted in the figure above, or the V (C) electrode should be placed by a clinician.

7.3.4.3 Standard 6-Leadwire Electrode Placement

For a 6-lead placement, use the positions from the 5-lead diagram above but with two chest leads. The two chest leads are Va and Vb per AHA standard, and are Ca and Cb per IEC standard. Va (Ca) and Vb (Cb) can be positioned at any two of the V1 (C1) to V6 (C6) positions shown in the chest electrode diagram below. The default position of Va and Ca is V1 and C1 respectively. The default position of Vb and Cb is V2 and C2 respectively

The positions of Va (Ca) and Vb (Cb) can also be placed at a proper position according to the clinician's needs.

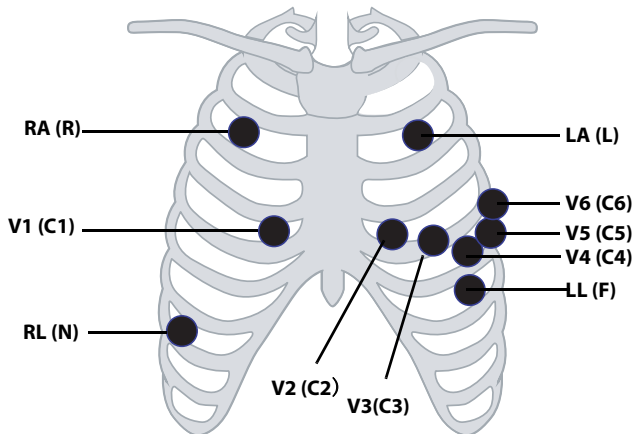

AHA	IEC	Electrode Placement
RA (white)	R (red)	At the patient's 2nd ICS midclavicular line to the right of the sternum.
LA (black)	L (yellow)	At the patient's 2nd ICS midclavicular line to the left of the sternum.
LL (red)	F (green)	On the patient's lower left chest wall within the ribcage frame.
RL (green)	N (black)	On the patient's lower right chest wall within the ribcage frame.
Va (brown)	Ca (white)	The Va (Ca) electrode is placed in any one of the positions from V1(C1)- V6(C6) positions. By default Va/Ca electrode is placed at V1(C1) and the Vb(Cb) electrode is placed at V2(C2).
V1 (brown)	C1 (white)	In the fourth intercostal space, right sternal border.
V2 (brown)	C2 (white)	In the fourth intercostal space, left sternal border.
V3 (brown)	C3 (white)	In the midway between V2 and V4 on a straight line.
V4 (brown)	C4 (white)	In the fifth intercostal space, mid-clavicular line.
V5 (brown)	C5 (white)	In the fifth intercostal space, anterior axillary line.
V6 (brown)	C6 (white)	In the fifth intercostal space, mid-axillary line.

7.3.4.4 Lead Placement: For Pacemaker Patients

The recommended lead placement for monitoring a pacemaker patient is as follows.

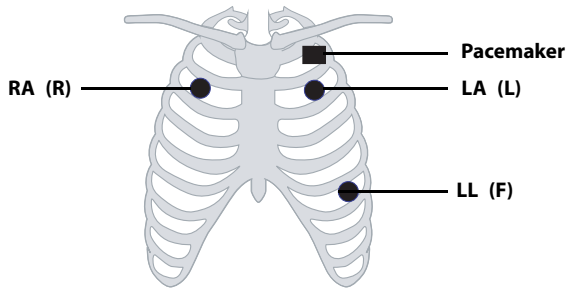

3-wire lead placement for a pacemaker patient (AHA)/(IEC)

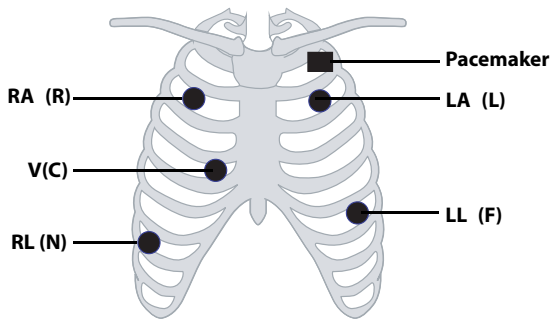

5-wire Lead Placement for a Pacemaker Patient (AHA)/(IEC)

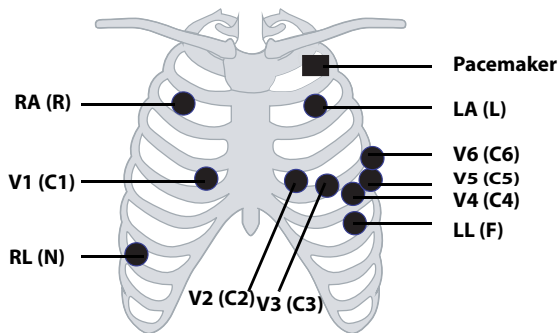

6-wire Lead Placement for a Pacemaker Patient (AHA)/(IEC)

A pacemaker patient usually requires a different electrode patch placement configuration than a non-pacemaker patient.

Do not place an ECG electrode directly over the pacemaker generator. Place the electrode patches 2 to 3 inches away from the pacemaker generator area. For example, if the pacemaker generator is located in the right subclavian area, relocate the Right Arm electrode closer in towards the center of the chest.

7.3.5 Checking the Lead Placement

With the Lead Placement function, you can check the lead status, information, and lead off messages.

7.3.5.1 Entering the Lead Placement Menu

Enter the **Lead Placement** menu in either of the following ways:

- Tap the ECG lead off message in the prompt message area of the main screen.
- Press the  key to enter the main menu → tap **Lead Placement**.

7.3.5.2 Understanding the Lead Placement Instructions

The **Lead Placement** window indicates the lead status.

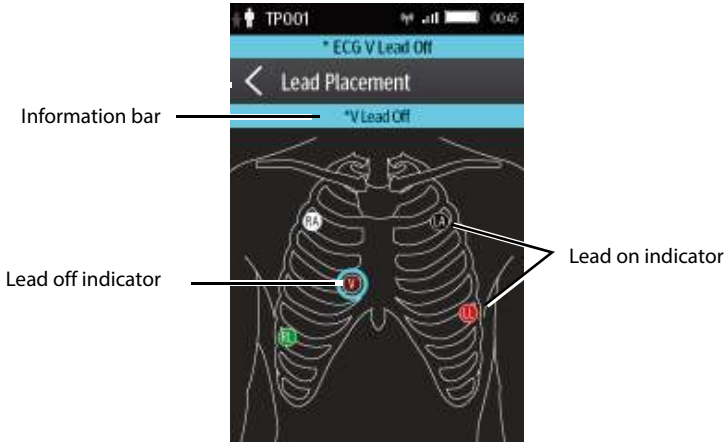

Example lead placement window

When any of the leads are off, the indications are as follows:

- The lead off message displays on the information bar.
The background color of the information bar corresponds to the alarm priority.
- A flashing circle indicates the disconnected lead.
The color of the flashing circle is based on the alarm priority.

7.3.6 Checking the Paced Status

To check the paced status, follow this procedure:

1. On the main screen, tap the HR digital area or ECG waveform area to enter the **ECG** menu.
2. In the **Pacer** section, check if **Paced** is appropriate for the patient.
3. If it is not correct, tap **Paced** and select the correct paced status. For details about the options, refer to **5.3.3 Changing the Paced Status**.

7.3.7 Maintaining Quality ECG Signal

Regardless of patient age, electrodes should be replaced at least every 24 hours to maintain quality signals during long-term monitoring. Over the course of 24 hours, the electrode gel will start to dry out and the adhesive will age. After a long period of time, the patient's sensitive skin also may be irritated by the gel or adhesive causing discomfort.

Stabilize the electrode and leadwire with a leadwire stress loop near the electrode. Tape the stress loop to the patient. A secured stress loop prevents leadwire rotation about the electrode snap, leadwire tugging at the electrode, and ECG artifact.

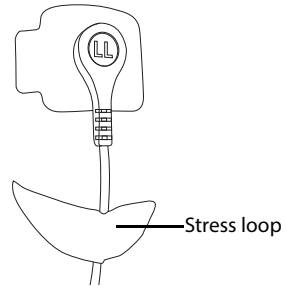

7.4 Changing ECG Settings

You can change the ECG settings from the **ECG** menu.

7.4.1 Entering the ECG Menu

Enter the **ECG** menu in either of the following ways:

- On the main screen, tap the HR digital area or ECG waveform area.
- Press the  key to enter the main menu → tap **Parameter Setup** → select **ECG**.

7.4.2 Configuring ECG Settings

To configure ECG settings:

1. In the **Setup** section of the **ECG** menu, select the options described in the following table.

Options	Description	Settings*
Lead Placement	Enters the Lead Placement window.	Refer to 7.3.5 Checking the Lead Placement for details.
Cable Type	Selects the current ECG leadwire type.	Auto , 3 Lead, 5 Lead, 6 Lead Refer to 7.4.3 ECG Leadwire Types for details.
Smart Lead (Monitored Lead)	Refer to 7.4.3 ECG Leadwire Types for details.	

* The factory default settings are in bold.

Options	Description	Settings*
Filter	Selects the ECG filter. <ul style="list-style-type: none"> ■ Monitor Used under normal measurement conditions. ■ ST Used when ST monitoring is applied. 	Monitor, ST
Color	Selects the color of ECG numeric data and waveform.	16 colors The default color is green.

* The factory default settings are in bold.

2. Tap the  icon to exit the **ECG** menu.

7.4.3 ECG Leadwire Types

ECG leadwire type has three options as follows:

- **Auto:** the device automatically sets the leadwire type according to the leads connected.
- **3 Lead:** the leadwire type is set to 3 lead.
 If the leadwire type is set to 3-lead, the **Smart Lead** option becomes **Monitored Lead**. You can select the desired lead from the **Monitored Lead** option to set the first ECG waveform displayed on the main screen.
- **5 Lead:** the leadwire types is set to 5 lead. The option displays **Smart Lead**.
 All waveform leads display on the main screen.
 Drag the switch to right or left to enable or disable the Smart Lead function.
- **6 Lead:** the leadwire types is set to 6 lead.
 If the leadwire type is set to 6 lead, there will be two options **Va** and **Vb** displayed under **Cable Type**.
 - ◆ **Va** options: Va, V1, V2, V3, V4, V5, V6. Va is the default.
 - ◆ **Vb** options: Vb, V1, V2, V3, V4, V5, V6. Vb is the default.

7.4.4 Configuring ECG Waveforms

To configure ECG waveforms, follow this procedure:

1. In the **Waveform** section of the **ECG** menu, select the options described in the following table.

Options	Description	Settings*
All Lead Size	Selects the waveform size for all the leads. To set the waveform size for a specific lead, select that lead from the Waveform Size field.	1.25 mm/mV, 2.5 mm/mV, 5 mm/mV, 10 mm/mV , 20 mm/mV, 40 mm/mV, Auto
	This configuration will be applied for all ECG waveform sizes.	
Speed	Selects the waveform sweep speed.	6.25 mm/s, 12.5 mm/s , 25 mm/s

* The factory default settings are in bold.

2. Tap the  icon to exit the **ECG** menu.

7.4.5 Configuring the Pacer

To configure the pacer, follow this procedure:

1. In the **Pacer** section of the **ECG** menu, select the options described in the following table.

Options	Description	Settings*
Paced	Selects the paced status.	Unspecified , No, Yes Unspecified is only available for the first time you set the paced status. Refer to 7.3.6 Checking the Paced Status for details.
Markers	Selects the pacer indicator. <ul style="list-style-type: none"> ■ Line A 1 cm line shows above each ECG waveform each time the pace pulse is detected. ■ Dot A 2 mm dot shows above each ECG waveform each time the pace pulse is detected. 	Line , Dot, Off
Pacer Reject	Selects whether or not to reject the pace pulses.	On, Off

* The factory default settings are in bold.

2. Tap the  icon to exit the **ECG** menu.

NOTE

- **When Paced is set to Yes, the Markers and Pacer Rejection options can be available.**

7.4.6 Configuring the ECG Waveform Size

The **Waveform Size** field of the **ECG** menu lists all available leads. You can select the desired ECG lead to set the waveform size. For details about the waveform size setting, refer to **7.4.4 Configuring ECG Waveforms**.

7.4.7 Configuring ECG Alarm Settings

To configure ECG alarm settings, follow this procedure:

1. In the **Alarms** section of the **ECG** menu, tap **ECG Alarm Setup**. The **Alarm Limits** menu is displayed.
2. Select the options described in the following table.

Options	Description	Settings*
HR/PR	Configures whether to trigger a HR/PR high or low alarm.	On, Off
		Alarm limit range: 16 bpm to 299 bpm; the step is 1bpm. The default alarm high limit is 120 for adult and is 160 for pediatric. The default alarm low limit is 50 for adult and is 75 for pediatric. The alarm high limit should be at least 2 bpm greater than the alarm low limit.
		Alarm priority: Med, High
Note: <ol style="list-style-type: none">1. When you change the high limit of HR/PR, the limit of Tachy will be automatically changed, and vice versa.2. When you change the low limit of HR/PR, the limit of Brady will be automatically changed, and vice versa.3. When you change the alarm priority of HR/PR, the alarm priority of Tachy/Brady will be automatically changed, and vice versa.		

* The factory default settings are in bold.

7.4.8 Configuring the Notch Filter

Notch filter filters out AC line noise from the ECG waveform. Refer to **12.3 Configuring the General Menu** for details.

7.5 Configuring the HR Alarm Source

In most cases, the HR and PR numerics are identical. In order to avoid simultaneous alarms on HR and PR, the telemetry monitor uses either HR or PR as its active alarm source.

To change the alarm source, follow this procedure:

1. In the **Parameter Setup** section of the **ECG** menu, tap **HR**.
2. In the **Setup** section, select the desired alarm source for **Alarm Source**. **Auto** is the default.
 - ◆ **HR**: if you want the HR to be the alarm source for HR/PR.
 - ◆ **PR**: if you want the PR to be the alarm source for HR/PR.
 - ◆ **Auto**: the telemetry monitor will use the heart rate from the ECG measurements as the alarm source whenever a valid heart rate is available. If the heart rate becomes unavailable, for example the ECG module becomes disconnected, the telemetry monitor will automatically switch to PR as the alarm source.
 - ◆ **Both**: both HR and PR are used as the alarm source for HR/PR.

NOTE

- When **Alarm Source** is set to **HR**, **systole beep** comes from heart beat. When **Alarm Source** is set to **PR**, **systole beep** comes from pulse rate.

7.6 Understanding the ECG Display

7.6.1 HR Digital Area



1. Parameter name
2. Measurement unit
3. Heart rate value
4. PR source: PR source is displayed when ECG leads are not connected and valid PR value is detected,
5. HR/PR alarm off symbol: when HR/PR alarm is switched on and valid HR/PR value is detected, HR/PR alarm high and low limits in place of the alarm off symbol are displayed.

NOTE

- **Both the HR value displayed on the telemetry monitor's main screen and that at the Central Station can meet relevant standards and are reliable. HR trended, alarm checking, and arrhythmia are based on the HR calculated at the Central Station.**
- **Please be noted that in case of weak wireless signals, the Central Station faces the risk of data loss and the HR value calculated by the ECG algorithm for the Central Station may have certain deviation.**

7.6.2 About the HR Digital Area

- The HR area displays heart rate in the unit of bpm with a resolution of 1 bpm.
- If the HR measurement is invalid, "--" displays in place of the HR value.
- The HR value displays "0" when the HR value is less than 15 bpm.

7.6.3 ECG Waveform Area



1. ECG Lead
2. ECG scale bar
3. ECG waveform
4. ECG filter setting
5. ECG scale

7.6.4 About the ECG Waveform Area

- The ECG waveform, scale indicator, lead, and filter settings display in the configured ECG color.
- The ECG waveform area provides scrolling, real-time waveform data and an erase bar to provide a time indicator of oldest and new data.
- The ECG waveform area scrolls the waveform at the configured sweep speed.
- The ECG waveform area indicates a Pacer indicator when a pace pulse is detected and Paced is enabled.

7.7 Arrhythmia Monitoring

Arrhythmia monitoring is intended for adult and pediatric patients.

7.7.1 Arrhythmia Safety Information

WARNING

- Heart rate reading may be affected by cardiac arrhythmias. Do not rely entirely on heart rate alarms when monitoring patients with arrhythmia. Always keep these patients under close surveillance.
 - The arrhythmia analysis program is intended to detect ventricular arrhythmias and atrial fibrillation. It is not designed to detect atrial or supraventricular arrhythmias. It may incorrectly identify the presence or absence of an arrhythmia. Therefore, a physician must analyze the arrhythmia information with other clinical findings.
-
-

CAUTION

- Since the arrhythmia detection algorithm sensitivity and specificity are less than 100%, sometimes there may be some false arrhythmias detected and also some true arrhythmia events may not be detected. This is especially true when the signal is noisy.
 - The ECG size and minimum QRS detection threshold settings affect arrhythmia detection and heart rate calculation sensitivity.
 - If QRS amplitude is low, the monitor might not be able to calculate heart rate and false asystole calls may occur. During the learning phase of the algorithm, arrhythmia detection may not be available. So you should closely monitor patient condition during and for several minutes after the learning phase to allow the algorithm to reach optimal detection performance.
-
-

7.7.2 Arrhythmia Events

This section lists all arrhythmia events and their criteria.

7.7.2.1 Lethal Arrhythmia Events

Arrhythmia message	Description
Asystole	No QRS complex detected within the set time interval in the absence of ventricular fibrillation or chaotic signal.

Arrhythmia message	Description
V-Fib/V-Tach	A fibrillatory wave for 6 consecutive seconds. A dominant rhythm of adjacent PVCs and the ventricular rate is greater than the V-Tach Rate limit.
V-Tach	The number of consecutive PVCs is greater than or equal to the V-Tach PVCs limit, and the ventricular rate is greater than or equal to the V-Tach rate limit.

7.7.2.2 Nonlethal Arrhythmia Events

Arrhythmia message	Description
Vent Brady	The number of consecutive PVCs is greater than or equal to V-Brady PVC limit and the ventricular rate is less than the V-Brady Rate limit.
Extreme Tachy	The heart rate is greater than the extreme tachycardia limit.
Extreme Brady	The heart rate is less than the extreme bradycardia limit.
R on T	R on T PVC is detected.
Run PVCs	More than two consecutive PVCs, but lower than the V-Brady PVCs limit, and the ventricular rate is lower than the V-Tach Rate limit.
Couplet	A Pair of PVCs detected in between normal beats.
Multiform PVC	Multiform PVCs detected in Multif PVCs Window (which is adjustable).
PVC	One PVC detected in between normal beats.
Bigeminy	A dominant rhythm of N, V, N, V, N, V.
Trigeminy	A dominant rhythm of N, N, V, N, N, V, N, N, V.
Tachy	The heart rate is greater than the tachycardia limit.
Brady	The heart rate is lower than the bradycardia limit.
Pacer Not Capture	No QRS complex detected for 300 ms following a pace pulse (for paced patients only).
Pacer Not Pacing	No pace pulse detected for 1.75 x average R-to-R intervals following a QRS complex (for paced patients only).

Missed Beats	At least 3 consecutive Ns, and The current RR interval is greater than 1.5 x previous RR interval, and The next RR interval is lower than 1.5 x average RR interval, and HR lower than 100 and the current RR interval is greater than 1.75 x average RR interval , or HR is greater than or equal to 100 and the current RR interval is greater than 1000 ms.
Nonsus V-Tach	The number of consecutive PVCs is lower than the V-Tach PVCs limit but greater than 2, and the ventricular rate is greater than or equal to the V-Tach Rate limit.
Vent Rhythm	The number of consecutive PVCs is greater than or equal to the V-Brady PVCs limit, and ventricular rate is greater than or equal to the V-Brady Rate limit but lower than V-Tach Rate limit.
Pause	No QRS complex is detected within the set time threshold of pause.
Irr Rhythm	Consistently irregular rhythm (N, irregular RR interval change is greater than 12.5%)
A-Fib	P wave is absent and normal beat RR intervals are irregular.
PVCs/min	PVCs/min exceeds high limit.
Pauses/min	Pauses/min exceeds high limit.
Irr Rhythm End	Irregular rhythm no longer detected for the irregular rhythm end delay time.
A-Fib End	Atrial fibrillation no longer detected for the A-Fib end delay time.

Note: N: normal beat; V: ventricular beat

7.7.3 Changing Arrhythmia Alarm Settings

To change arrhythmia alarm settings, follow this procedure:

1. On the main screen, tap the HR digital area or ECG waveform area to enter the **ECG** menu.
2. In the **Parameter Setup** section, tap **Arrhythmia**.
3. Tap **Arrhythmia Alarm Setup**. The **Arrhythmia Alarm Setup** menu is displayed.
4. In the **Setup** section, select the desired option:
 - ◆ **All On**: switches on all arrhythmia alarms.
 - ◆ **All Off**: switches off all arrhythmia alarms. This button becomes inactive when **Lethal Arrhy Alarms Off** is disabled in the **System Setup** menu of the CMS.
 - ◆ **Lethals Only**: switches on all the lethal arrhythmia alarms only. Other types of arrhythmia alarms are off.
5. In the **Alarms** section, select the options described in the following table.

Options	Description	Settings*
Asystole	Configures arrhythmia alarms.	On, Off
		Asystole Delay: 3 seconds to 10 seconds The default is 5 sec.
		Alarm priority: High
V-Fib/V-Tach		On, Off
		Alarm priority: High
V-Tach		On, Off
	V-Tach PVCs: 3 beats to 99 beats; the default is 6 beats.	
	V-Tach Rate: 100 bpm~200 bpm; the default is 130 bpm.	
	Alarm priority: High	

* The factory default settings are in bold.

Options	Description	Settings*
Vent Brady	Configures arrhythmia alarms.	On, Off
		V-Brady PVCs: 3 beats to 99 beats; the default is 5 beats . V-Brady Rate: 15 bpm to 60 bpm; the default is 40 bpm .
		Alarm priority: High
Extreme Tachy		On, Off
		Extreme Tachy: 61 bpm to 300 bpm; the default is 160 for adult and 180 for pediatric. Alarm priority: High
Extreme Brady		On, Off
		Extreme Brady: 15 bpm to 119 bpm; the default is 35 for adult and 50 for pediatric. Alarm priority: High
R on T		On, Off
		Alarm priority: Prompt, Low, Med , High
Run PVCs	On, Off	
	Alarm priority: Prompt, Low , Med, High	
Couplet	On, Off	
	Alarm priority: Prompt , Low, Med, High	
Multiform PVC	On, Off	
	Multif PVCs Window: 3 beats to 31 beats; the default is 15 beats . Alarm priority: Prompt, Low, Med , High	
	On, Off	
PVC	On, Off	
	Alarm priority: Prompt , Low, Med, High	

* The factory default settings are in bold.

Options	Description	Settings*
Bigeminy	Configures arrhythmia alarms.	On, Off
		Alarm priority: Prompt, Low, Med , High
Trigeminy		On, Off
		Alarm priority: Prompt, Low, Med , High
Tachy		On, Off
		60 bpm to 299 bpm; the default Tachy threshold is consistent with the HR alarm high limit.
		Alarm priority: Med , High
Brady		On, Off
		16 bpm to 120 bpm; the default Brady threshold is consistent with the HR alarm low limit.
		Alarm priority: Med , High
Pacer Not Capture		On, Off
		Alarm priority: Prompt , Low, Med, High
Pacer Not Pacing		On, Off
		Alarm priority: Prompt , Low, Med, High
Missed Beats	On, Off	
	Alarm priority: Prompt , Low, Med, High	
Nonsus V-Tach	On, Off	
	Alarm priority: Prompt, Low, Med , High	
Vent Rhythm	On , Off	
	Alarm priority: Prompt, Low, Med , High	
Pause	On, Off	
	Pause Time: 1.5s, 2.0s , 2.5s, 3.0s	
	Alarm priority: Prompt, Low , Med, High	

* The factory default settings are in bold.

Options	Description	Settings*
Irr Rhythm	Configures arrhythmia alarms.	On, Off
		AF/Irr Rhy End Time: 0 min, 1 min, 2 min , 3 min, 4 min, 5 min, 10 min, 15 min, 30 min
		Alarm priority: Prompt , Low
A-Fib		On, Off
		AF/Irr Rhy End Time: 0 min, 1 min, 2 min , 3 min, 4 min, 5 min, 10 min, 15 min, 30 min
		Alarm priority: Prompt , Low, Med, High
PVCs/min		On, Off
		PVCs /min: 1 to 100; the default is 10 .
		Alarm priority: Prompt, Low, Med , High
Pauses/min		On, Off
		Pauses/min: 1 to 15; the default is 8 .
		Alarm priority: Prompt, Low, Med , High

* The factory default settings are in bold.

WARNING

- **If you switch off all arrhythmia alarms, the monitor will not alarm for any arrhythmia event. This may result in a hazard to the patient. Always keep the patient under close surveillance.**
-

NOTE

- **The priority of lethal arrhythmia alarms is always high.**
 - **When the telemetry monitor is connected to the CMS, any changes made either at the telemetry monitor or the CMS will be communicated to the other side.**
 - **When lethal arrhythmia alarms are set to Disable at the CMS, the  symbol is displayed on the lethal arrhythmia alarms at the telemetry monitor.**
 - **If any of the lethal arrhythmia alarms is switched off, the ECG waveform area at the telemetry monitor displays the "Lethal Arrhys Off" message. The ECG waveform area on the screen of the CMS displays Asystole, V-Fib/V-Tach, or V-Tach Off depending on the actual lethal arrhythmia alarm.**
-

7.7.4 Intelligent Arrhythmia Alarm

Normally, an arrhythmia alarm is presented when an alarm condition is detected. However, there are certain situations that can inhibit audible and visible alarm indications even though an alarm condition was detected.

7.7.4.1 Arrhythmia Alarm Chains

If multiple alarms overlap, announcing all of the detected alarm conditions would be confusing, and a more serious condition might be overlooked. So arrhythmia alarms are prioritized by alarm “chains”.

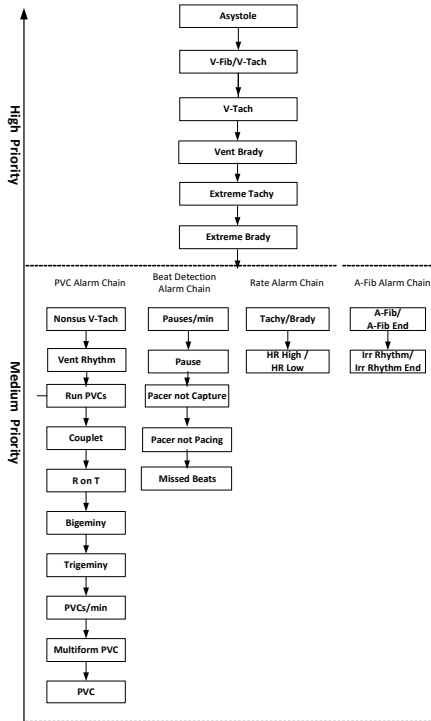

7.7.4.2 Configuring the Arrhythmia Alarm Timeout Period

The arrhythmia algorithm can disable alarm light and alarm tone for designated period of time when certain arrhythmia alarms are detected.

You can set the arrhythmia alarm timeout period at the CMS. For how to configure the arrhythmia alarm timeout period, refer to **13.7.2 Configuring the Arrhythmia Shield Time**.

NOTE

- For the following alarms, alarm light and alarm tone cannot be disabled: HR high, HR low, Tachycardia, Bradycardia, A-Fib End, Irr Rhythm End.
- The arrhythmia alarm timeout period is only applied to the medium priority chains and atrial fibrillation chain. For the alarms in the high priority chain, alarm tone and alarm light are presented as soon as the alarm condition is detected. For more information on the arrhythmia alarm chain, refer to 7.7.4.1 Arrhythmia Alarm Chains.

7.7.4.3 Arrhythmia Alarm Refractory Period

For the following eight alarms in medium priority chain, there is a 30-second refractory period. That is to say, the same alarm is not presented within 30 seconds after the previous alarm disappears.

- Couplet
- R on T
- PVCs/min High
- Multiform PVCs
- PVC
- Missed Beats
- Pacer Not Capture
- Pacer Not Pacing

7.7.5 Understanding the Arrhythmia Display

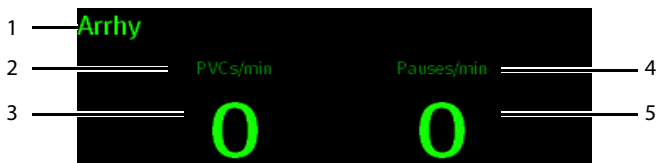

1. Parameter label
2. PVCs per minute label
3. PVCs per minute value
4. Pauses per minute label
5. Pauses per minute value

7.8 ST Segment Monitoring

ST segment analysis is intended for adult and pediatric patients.

When the telemetry monitor is connected to the CMS, you can adjust ST points, enter the ST graphic window and the ST view at the CMS. For more information, refer to **13.6 ST Monitoring**.

7.8.1 ST Safety Information

WARNING

- **ST values may be affected by such factors as some drugs or metabolic and conduction disturbances.**
 - **When the telemetry monitor is connected to the CMS, the CMS provides information regarding changes in ST deviation levels. The clinical significance of the ST level change information should be determined by a physician.**
-
-

7.8.2 Enabling ST Monitoring

The ST monitoring function is disabled by default. Before you start ST monitoring, enable the ST function. To do so, follow this procedure:

1. On the main screen, tap the HR digital area or ECG waveform area to enter the **ECG** menu.
2. In the **Parameter Setup** section, tap **ST**.
3. Switch on **ST Analysis**.

Reliable ST monitoring can hardly be ensured if:

- You are unable to get a lead that is not noisy.
- Arrhythmias, such as atrial fibrillation or atrial flutter, which may cause an irregular baseline.
- The patient is continuously ventricularly paced.
- The patient has left bundle branch block.

In these cases, you may consider switching off ST monitoring.

7.8.3 Displaying ST Numerics

When **ST Analysis** is switched on, ST digital area is displayed on the screen. The location of the ST digital area is dependent on the display configurations. For how to set the location of the ST digital area, refer to **4.2 Configuring the Display**.

Numerics displayed in the ST digital area are different according to the lead type:

- When the 3-lead ECG leadwires are used, the ST digital area is not displayed. A ST value is displayed in the HR digital area.

- When the 5-lead ECG leadwires are used, seven ST values (ST-I, ST-II, ST-III, ST-aVR, ST-aVL, ST-aVF, ST-V) are displayed in the ST digital area.
- When the 6-lead ECG leadwires are used, eight ST values (ST-I, ST-II, ST-III, ST-aVR, ST-aVL, ST-aVF, ST-Va, ST-Vb) are displayed in the ST digital area.

This example shows the ST digital area when the 6-lead ECG leadwires are used. Your screen may look slightly different:

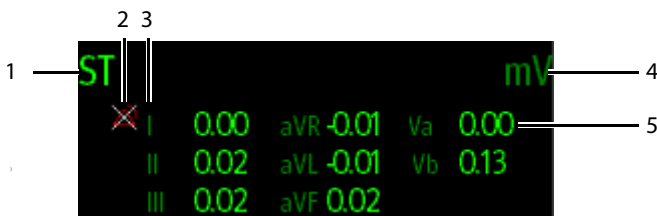

1. Parameter label
2. ST alarm off symbol
3. Lead label
4. ST unit
5. ST numerics: a positive value indicates ST segment elevation, and a negative value indicates ST segment depression.

7.8.4 Configuring ST Alarm Settings

To configure ST alarm settings, follow this procedure:

1. Tap the ST digital area to enter the **ST** menu.
2. Tap **ST Alarm Setup**.
3. In the **Setup** section, tap **ST Alarm Mode** and then select the desired mode:
 - ◆ **Absolute:** you can separately set the alarm properties for each ST alarm. After selecting this option, the Auto Limits option is displayed where you can initiate auto adjustment of alarm limits.
 - ◆ **Relative:** it is the default option. You can set the alarm properties for **ST Single** and **ST Dual** alarms.
4. In the **Alarms** section, select the options described in the following table.

Options	Description	Settings*
ST-I, ST-II, ST-III, ST-aVR, ST-aVF, ST-V, ST-Va, ST-Vb	These options are displayed when ST Alarm Mode is set to Absolute . The lead label behind ST is consistent with the ECG cable type selected.	On, Off Alarm high limit range: 0.2 mV to 2.0 mV; the default is 0.2 ; the step is 0.01mV. Alarm low limit range: -2.0 mV to 0 mV; the default is -0.2 ; the step is 0.01mV. Alarm priority: Low, Med , High
ST Single	These options are displayed when ST Alarm Mode is set to Relative .	On, Off Alarm high limit range: 0 mV to 2.0 mV; the default is 0.1 ; the step is 0.01mV. Alarm low limit range: -2.0 mV to 0 mV; the default is -0.1 ; the step is 0.01mV. Alarm priority: Low, Med , High
ST Dual		On, Off Alarm high limit range: 0 mV to 2.0 mV; the default is 0.1 ; the step is 0.01mV. Alarm low limit range: -2.0 mV to 0 mV; the default is -0.1 ; the step is 0.01mV. Alarm priority: Low, Med , High

* The factory default settings are in bold.

7.9 QT/QTc Interval Monitoring

The QT interval is defined as the time between the beginning of the Q-wave and the end of the T-wave. It measures the total duration of ventricular depolarization (QRS duration) and repolarization (ST-T). QT interval monitoring can assist in the detection of long QT syndrome.

The QT interval has an inverse relationship to heart rate. Faster heart rates shorten the QT interval and slower heart rates prolong the QT interval. Therefore, several formulas can be used to correct the QT interval for heart rate. The heart rate corrected QT interval is abbreviated as QTc.

QT/QTc interval monitoring is intended for adult and pediatric patients.

When the telemetry monitor is connected to the CMS, you can set the QTc formula and enter the QT view at the CMS. For more information, refer to **13.4 Setting the Analysis Leads**.

7.9.1 QT/QTc Monitoring Limitations

Some conditions may make it difficult to achieve reliable QT/QTc monitoring, for example:

- R-wave amplitudes are too low
- The presence of frequent ventricular ectopic beats
- Unstable RR intervals
- P-waves tending to encroach on the end of the previous T-wave at high heart rates
- The T-wave is very flat or T-wave are not well defined
- The end of the T-wave is difficult to delineate because of the presence of U-waves
- QTc measurements are not stable
- In the presence of noise, asystole, ventricular fibrillation, atrial fibrillation, and ECG lead off

For these cases you should select a lead with good T-wave amplitude and no visible flutter activity, and without a predominant U-wave or P-wave.

Some conditions such as left or right bundle branch block or hypertrophy can lead to a widened QRS complex. If a long QTc is observed you should verify it to ensure that it is not caused by QRS widening.

Because normal beats followed by ventricular beats are not included in the analysis, no QT measurement will be generated in the presence of a bigeminy rhythm.

If the heart rate is extremely high (over 150bpm for adults and over 180bpm for pediatrics and neonates), QT will not be measured. When the heart rate changes, it can take several minutes for the QT interval to stabilize. For reliable QTc calculation it is important to avoid measurements when the heart rate is changing.

7.9.2 Enabling QT/QTc Monitoring

The QT monitoring function is disabled by default. Before you start QT monitoring, enable the QT function. To do so, follow this procedure:

1. On the main screen, tap the HR digital area or ECG waveform area to enter the **ECG** menu.
2. In the **Parameter Setup** section, tap **QT/QTc**.
3. Switch on **QT Analysis**.

NOTE

7.9.3 Displaying QT/QTc Numerics and Segments

After **QT Analysis** is switched on, QT digital area is displayed on the screen. The location of the QT digital area is dependent on the display configurations. For how to set the location of the QT digital area, refer to **4.2 Configuring the Display**.

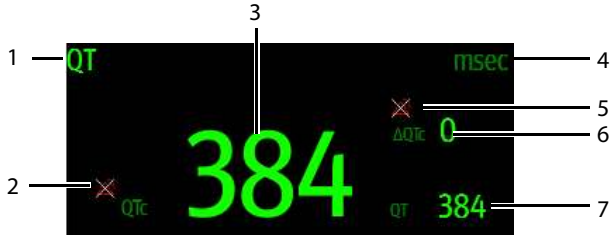

1. Parameter label
2. QT alarm off symbol
3. QTc value
4. Measurement unit
5. ΔQTc alarm off symbol
6. ΔQTc value (the difference between the current and baseline QTc values)
7. QT value

7.9.4 Configuring QT/QTc Alarm Settings

To configure QT/QTc alarm settings:

1. Tap the QT digital area to enter the **QT/QTc** menu.
2. Tap **QT/QTc Alarm Setup**.
3. Select the options described in the following table.

Options	Description	Settings*
QTc	Configures whether to trigger the QTc alarm.	On, Off
		Alarm high limit range: 200 ms to 800ms; the step is 1ms. The default is 500 for adult and the default is 480 for pediatric.
		Alarm priority: Low, Med , High

* The factory default settings are in bold.

Options	Description	Settings*
ΔQTc	Configures whether to trigger the ΔQTc alarm.	On, Off
		Alarm high limit range: 30ms to 200 ms; the step is 1ms. The default is 60 .
		Alarm priority: Low, Med , High

* The factory default settings are in bold.

4. Tap the  icon to return to the previous menu.

7.10 Relearning

Changes in ECG beat morphology could result in incorrect arrhythmia alarms and/or inaccurate heart rate. ECG relearning allows the telemetry monitor to learn the new dominant beat morphology and thus reduce false arrhythmia alarms and inaccurate HR values. Once learning is complete, the dominant QRS complex is stored as a reference template. The reference template is used as the normal morphology of that patient and it is compared with incoming beats to identify possible arrhythmias.

NOTE

- **ST Analysis must be turned on before it will relearn.**

7.10.1 Automatically Initiating an ECG Relearning

Auto arrhythmia relearning is initiated in the following situation:

- The ECG lead type or lead label is changed.
- ECG leads are off and are not reconnected within 60 seconds.
- The patient's paced status is changed.
- The patient's category is changed.
- A patient is discharged.
- After ECG calibration is completed, the **Calibrate ECG** option is disabled.
- When **Cable Type** is set to **3 Lead**, the monitored lead is changed.

7.10.2 Manually Initiating an ECG Relearning

If you suspect that false arrhythmia alarms are presented, you may need to manually initiate an ECG relearn.

To do so, follow this procedure:

1. On the main screen, tap the QT digital area to enter the **QT/QTc** menu.

2. Tap **Relearn**.

OR

1. On the main screen, tap the arrhythmia digital area to enter the **Arrhythmia** menu.

2. Tap **Relearn**.

OR

1. On the main screen, tap the ST digital area to enter the **ST** menu.

2. Tap **Relearn**.

CAUTION

- **Initiate ECG relearning only during periods of predominantly normal rhythm and when the ECG signal is relatively noise-free. If ECG learning takes place during arrhythmias, the ectopic beats may be incorrectly learned as normal QRS complexes. This may result in missed detection of subsequent arrhythmia events.**
-

8 Monitoring Respiration (Resp) (Optional)

8.1 Introduction

Impedance respiration is measured across the thorax. When the patient is breathing or ventilated, the volume of air changes in the lungs, resulting in impedance changes between the electrodes. Respiration rate (RR) is calculated from these impedance changes, and a respiration waveform appears on the screen.

Resp monitoring is intended for adult and pediatric patients.

8.2 Resp Safety Information

WARNING

- **If you do not set the detection level for the respiration correctly in manual detection mode, it may not be possible for the telemetry monitor to detect apnea. If you set the detection level too low, the telemetry monitor is more likely to detect cardiac activity, and to falsely interpret cardiac activity as respiratory activity in the case of apnea.**
 - **If operating under conditions according to the EMC Standard IEC 60601-1-2 (Radiated Immunity 3V/m), field strengths above 3V/m may cause erroneous measurements at various frequencies. Therefore, it is recommended to avoid the use of electrically radiating equipment in close proximity to the respiration measurement unit.**
-
-

CAUTION

- **Only use parts and accessories specified in this manual.**
 - **Respiration monitoring is not for use on the patients who are very active, as this will cause false alarms.**
-

8.3 Preparation for Monitoring Resp

8.3.1 Preparing the Patient's Skin

To prepare the patient's skin, follow this procedure:

1. Shave the chest hair from the electrode sites in a circular area with a diameter of 2 to 4 inches.
2. Use a dry gauze pad to remove excess skin oils, skin cells and residue from the electrode sites. Never rub the skin until it is raw or bleeding.

NOTE

- **Proper skin preparation is necessary for good signal quality at the electrode site, as the skin is a poor conductor of electricity.**

8.3.2 Positioning the Electrodes

As the Respiration measurement adopts the standard ECG electrode placement, you can use different ECG cables. Since the respiration signal is measured between two ECG electrodes, if a standard ECG electrode placement is applied, the two electrodes should be RA and LL of ECG Lead II.

For more information, refer to **7.3.4.1 Standard 3-Leadwire Electrode Placement..**

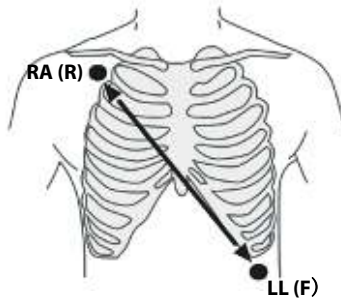

Lead II

CAUTION

- **Correct electrodes placement can help to reduce cardiac overlay: avoid the liver area and the ventricles of the heart in the line between the respiratory electrodes. This is particularly important for neonates.**
 - **Some patients with restricted movements breathe mainly abdominally. In these cases, you may need to place the left leg electrode on the left abdomen at the point of maximum abdominal expansion to optimize the respiratory wave.**
 - **In clinical applications, some patients expand their chests laterally, causing a negative intrathoracic pressure. In these cases, it is better to place the two respiration electrodes in the right midaxillary and the left lateral chest areas at the patient's maximum point of the breathing movement to optimize the respiratory waveform.**
 - **Periodically inspect the electrode application site to ensure skin quality. If the skin quality changes, replace the electrodes or change the application site.**
-

NOTE

- **Store the electrodes at room temperature. Open the electrode package immediately prior to use.**
 - **Check that the electrode packages are intact and not expired. Make sure the electrode gel is moist.**
-

8.4 Changing Resp Settings

You can change Resp settings from the **Resp** menu.

8.4.1 Enabling/Disabling the Resp Functionality

You can configure whether to display the Resp digital data and waveform on the main screen.

To do so, follow this procedure:

1. In the main menu, tap **Parameter Setup**.
2. In the **Commands** section, enable or disable **Resp**.

When **Resp** is enabled, the Resp digital data and waveform are displayed on the main screen. Besides, the **Resp** option is displayed in the list of parameters in the **Setup** section of the **Parameter Setup** menu.

8.4.2 Entering the Resp Menu

When the Resp functionality is enabled, you can enter the **Resp** menu in either of the following ways:

- On the main screen, tap the Resp digital area or waveform area.

- Press the  key to enter the main menu → tap **Parameter Setup** → tap **Resp.**

8.4.3 Configuring the Resp Setup

To configure the Resp setup, follow this procedure:

1. In the **Setup** section of the **Resp** menu, select the options described in the following table.

Options	Description	Settings*
NCM Alarm Delay	The telemetry monitor will trigger the “No Chest Movement” alarm if the patient has stopped breathing for longer than the set apnea time.	10s, 15s, 20s , 25s, 30s, 35s, 40s
Color	Selects the color of Resp digital data and waveform.	16 colors The default color is yellow.

* The factory default settings are in bold.

2. Tap the  icon to exit the **Resp** menu.

8.4.4 Configuring the Resp Waveform

To configure the Resp waveform, follow this procedure:

1. In the **Waveform** section of the **Resp** menu, select the options described in the following table.

Options	Description	Settings*
Gain	Selects the waveform size.	x0.25, x 0.5, x 1, x2 , x3, x4, x5
Speed	Selects the waveform sweep speed.	3mm/s, 6.25 mm/s , 12.5 mm/s, 25 mm/s

* The factory default settings are in bold.

2. Tap the  icon to exit the **Resp** menu.

8.4.5 Configuring Resp Alarm Settings

To configure Resp alarm settings, follow this procedure:

1. In the **Alarms** section of the **Resp** menu, tap **Resp Alarm Setup**.
2. Select the options described in the following table.

Options	Description	Settings*
RR	<p>Configures whether to switch on the Respiration alarm. RR defaults to be switched on.</p> <p>After tapping RR, you can configure alarm limits and alarm priority.</p>	<p>On, Off</p> <p>Alarm limit range: 0 rpm to 100 rpm; the step is 1bpm.</p> <p>The default alarm high limit is 30 and the default alarm low limit is 8.</p> <p>The alarm high limit should be at least 2 rpm greater than the alarm low limit.</p> <p>Alarm Priority: Low, Med, High</p>
No Chest Movement	<p>The telemetry monitor will trigger the “No Chest Movement” alarm if the patient has stopped breathing for longer than the set apnea time. This option defaults to be switched on.</p> <p>When the telemetry monitor is connected to the Central Monitoring System, switching on or off this option at the Central Monitoring System also switches it on or off at the telemetry monitor, and vice versa.</p> <p>After tapping this option, you can configure the alarm priority.</p>	<p>Alarm Priority: High</p>

* The factory default settings are in bold.

8.5 Understanding the Resp Display

8.5.1 Resp Digital Area



1. Parameter name
2. Measurement unit
3. Respiration rate (RR)

- Alarm high limit and low limit. When RR alarm is switched off, the alarm off symbol  instead of alarm limits is displayed.

8.5.2 About the Resp Digital Area

- The Resp digital area displays the respiration rate in the unit of RPM with a resolution of 1 RPM.
- If the Resp measurement is invalid, "--" displays in place of the RR value.

8.5.3 Resp Waveform Area

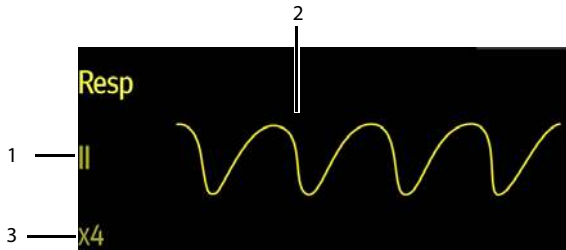

- Resp lead label
- Resp waveform
- Resp waveform gain

8.5.4 About the Resp Waveform Area

- The Resp waveform, lead label, and waveform gain display in the configured Resp color.
- The Resp waveform area scrolls the waveform at the configured sweep speed.

9 Monitoring Pulse Oxygen Saturation (SpO₂) (Optional)

9.1 Introduction

Pulse Oxygen Saturation (SpO₂) monitoring is a non-invasive technique used to measure the amount of oxygenated hemoglobin and pulse rate by measuring the absorption of selected wavelengths of light. The light generated in the probe passes through the tissue and is converted into electrical signals by the photo detector in the probe. The SpO₂ module processes the electrical signal and displays a waveform and digital values for SpO₂ and pulse rate.

The telemetry monitor can be configured with Masimo SpO₂ module or Nellcor SpO₂ module.

For details about the SpO₂ parameter setup at the Central Monitoring System, refer to **13 Monitoring with the Telemetry Monitor at the CMS**.

NOTE

- **A functional tester or SpO₂ simulator cannot be used to assess the accuracy of a SpO₂ module or a SpO₂ sensor.**
 - **This device is calibrated to display functional oxygen saturation.**
 - **A pulse oximeter should not be used as an apnea monitor.**
 - **Pulse rate measurement is based on the optical detection of a peripheral flow pulse and therefore may not detect certain arrhythmias. The pulse oximeter should not be used as a replacement or substitute for ECG based arrhythmia analysis.**
 - **The MS board pulse oximeter can be used during defibrillation, but the readings may be inaccurate for a short time.**
-

9.2 Measurement Limitations

The following factors may influence the accuracy of SpO₂ measurement:

- Patient physiological characteristics:
 - ◆ Cardiac arrest
 - ◆ Hypotension

- ◆ Darkly pigmented skin
- ◆ Shock
- ◆ Severe vasoconstriction
- ◆ Hypothermia
- ◆ Severe anemia
- ◆ Ventricular septal defects (VSDs)
- ◆ Venous pulsations
- ◆ Poor perfusion
- ◆ Dysfunctional hemoglobin, such as carboxyhemoglobin (COHb) and methemoglobin (MetHb)
- ◆ Elevated levels of bilirubin
- ◆ Vasospastic disease, such as Raynaud's, and peripheral vascular disease
- ◆ Hemoglobinopathies and synthesis disorders such as thalassemias, Hb s, Hb c, sickle cell, etc.
- ◆ Hypocapnic or hypercapnic conditions
- ◆ Birthmark(s), tattoos, skin discolorations, moisture on skin, deformed or abnormal fingers. etc.
- Interfering substances:
 - ◆ Intravascular dyes (such as indocyanine green, methylene blue, indigo carmine, etc.)
 - ◆ Dyes in the measure site, such as nail polish.
- Environmental conditions:
 - ◆ Excessive ambient light
 - ◆ Electrosurgery equipment
 - ◆ Defibrillation (may cause inaccurate reading for a short amount of time)
 - ◆ Excessive patient/sensor motion
 - ◆ Electromagnetic field
 - ◆ Arterial catheters and intra-aortic balloon
- Others
 - ◆ Inappropriate positioning of the SpO₂ sensor, or use of incorrect SpO₂ sensor
 - ◆ Cuff or arterial blood pressure measurement device on the same limb as the SpO₂ sensor.

9.3 Safety

WARNING

- Only use SpO₂ sensors specified in this manual. Follow the SpO₂ sensor's instructions for use and adhere to all warnings and cautions.
- The operator is responsible for checking the compatibility of the pulse oximetry monitor, sensor, and patient cable prior to use. Incompatible components can result in degraded performance and/or device malfunction.
- When a trend toward patient deoxygenation is indicated, blood samples should be analyzed by a laboratory co-oximeter to completely understand the patient's condition.
- Do not use SpO₂ sensors during magnetic resonance imaging (MRI). Induced current could potentially cause burns. The sensor may affect the MRI image, and the MRI unit may affect the accuracy of the oximetry measurements.
- Prolonged and continuous monitoring may increase the temperature of the sensor and cause the patient discomfort. It is especially important to check the sensor placement, and ensure proper attachment on patients suffering from poor perfusion or skin sensitivity. Check the sensor location every two to three hours and move to another location if the skin deteriorates. More frequent examinations may be required for different patients.
- Change the application site or replace the sensor and/or patient cable when a persistent SpO₂ Low Signal Quality message is displayed on the equipment. These messages may indicate that patient monitoring time is exhausted on the patient cable or sensor.
- Replace the cable or sensor when a "SpO₂ Sensor Off", "SpO₂ No Sensor", or "SpO₂ Low Signal" message is consistently displayed while monitoring consecutive patients after completing troubleshooting steps listed in this manual.
- Check accessory compatibility prior to use. Incompatible accessories may degrade the device's performance and may cause harm to the patient.
- Do not use disposable SpO₂ sensor for multiple times. Otherwise, inaccurate SpO₂ measurement may occur.
- A functional tester or SpO₂ simulator cannot be used to assess the accuracy of a SpO₂ module or a SpO₂ sensor. The accuracy of a SpO₂ module or a SpO₂ sensor needs to be validated by clinical data.
- Check accessory compatibility prior to use. Incompatible accessories may degrade the device's performance and may cause harm to the patient.
- Do not use disposable SpO₂ sensor for multiple times. Otherwise, inaccurate SpO₂ measurement may occur.

- **SpO₂ is empirically calibrated in healthy adult volunteers with normal levels of carboxyhemoglobin(COHb) and methemoglobin (MetHb).**
 - **When patients are undergoing photodynamic therapy they may be sensitive to light sources. Pulse oximetry may be used only under careful clinical supervision for short time periods to minimize interference with photodynamic therapy.**
 - **Additional information specific to the Masimo sensors compatible with the pulse oximeter, including information about parameter/measurement performance during motion and low perfusion, may be found in the sensor's directions for use (DFU).**
 - **To protect from electric shock, always remove the sensor and completely disconnect the pulse oximeter before bathing the patient.**
 - **The pulse oximeter is not an apnea monitor.**
 - **The pulse oximeter should not be used for arrhythmia analysis.**
-
-

CAUTION

- **Do not place the pulse oximeter where the controls can be changed by the patient.**
 - **If using pulse oximetry during full body irradiation, keep the sensor out of the radiation field. If the sensor is exposed to the radiation, the reading might be inaccurate or the device might read zero for the duration of the active irradiation period.**
-

9.4 Connecting the SpO₂ Module

Connect the SpO₂ module to the telemetry monitor. The telemetry monitor can auto detect the SpO₂ module type when the SpO₂ module is connected.

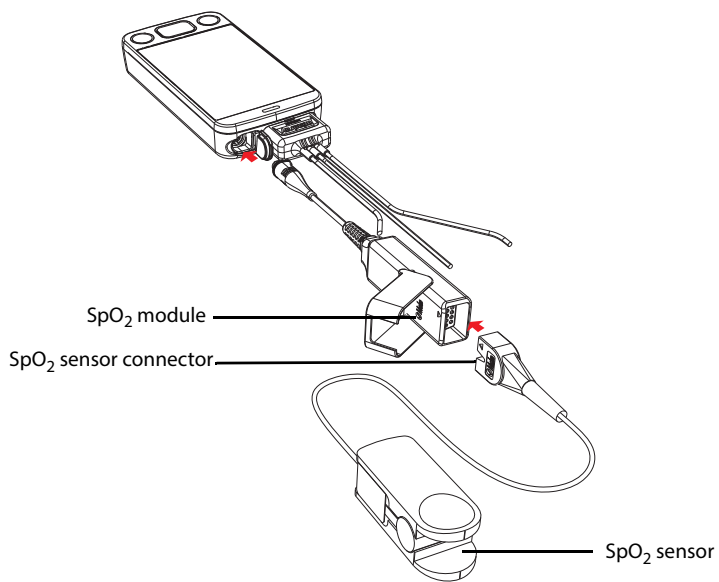

Connecting the Masimo SpO₂ module

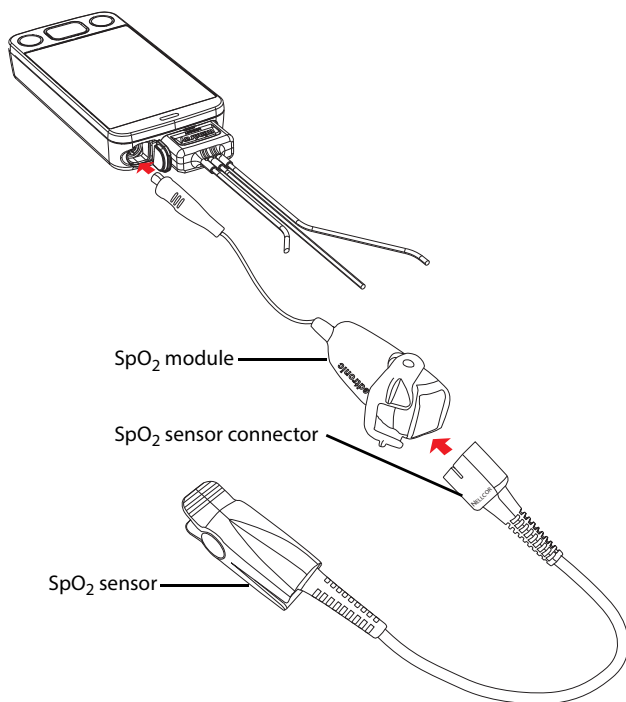

Connecting the Nellcor SpO₂ module

9.5 Changing the SpO₂ Settings

You can change the SpO₂ settings from the **SpO₂** menu.

9.5.1 Configuring the SpO₂ Setup

Enter the **SpO₂** menu in either of the following ways:

- On the main screen, tap the SpO₂ digital area or SpO₂ waveform area.
- Press the  key to enter the main menu → tap **Parameter Setup** → select **SpO₂**.

1. In the **Setup** section of the **SpO₂** menu, select the options described in the following table.

Options	Description	Settings*
Display PI (Masimo only)	<p>Configures whether or not to show the perfusion index (PI) value in the digital area.</p> <p>The perfusion index allows clinicians to assess the pulse strength at the monitoring site for optimal sensor placement.</p> <p>PI gives the numerical value for the pulsatile portion of the measured signal caused by arterial pulsation. PI is an indicator of the pulsatile strength.</p>	On, Off
Sensitivity (Masimo only)	<p>Selects the sensitivity mode depending upon signal quality and patient motion.</p> <p>High:</p> <p>This mode should be used for the sickest patients, where obtaining a reading is most difficult. High Sensitivity is designed to interpret and display data for even the weakest of signals. This mode is recommended during procedures and when clinician and patient contact is continuous.</p> <p>Normal:</p> <p>This mode provides the best combination of sensitivity and probe off detection performance. This mode is recommended for the majority of patients.</p> <p>APOD (Adaptive Probe Off Detection):</p> <p>This mode is the least sensitive in picking up a reading on patients with low perfusion but has the best detection for probe-off conditions. This mode is useful for patients that are at particular risk of the sensor becoming detached (pediatric, combative, etc.)</p>	High, Normal, and APOD

* The factory default settings are in bold.

Options	Description	Settings*
Averaging (Masimo only)	<p>The user-selectable averaging feature allows the clinician to select the desired level of visibility to subtle variations in the measured value. Depending on the patient acuity and area of care, shorter averaging times are sometimes preferred (sleep testing) over longer averaging times (telemetry) and vice-versa.</p> <p>8-second averaging is generally considered the most common averaging interval and recommended for most patients since it is short enough to provide visibility to subtle desaturations while also being long enough to minimize major changes in SpO₂ due to quick, transitory desaturations. Although averaging times greater than 10 seconds are more likely to reduce visibility to rapid, brief desaturations, this may be desirable in care areas where brief desaturations that do not require clinician intervention occur more often (such as NICU). It is also recommended that this be enabled as a "sticky" configuration so as to hold the setting after power cycles.</p>	2-4 sec, 4-6 sec, 8 sec , 10 sec, 12 sec, 14 sec, 16 sec
Fast SAT (Masimo only)	Selects whether or not to enable FastSat. FastSat enables rapid tracking of arterial oxygen saturation changes.	On , Off
Sat-Seconds (Nellcor only)	Selects the amount of time that SpO ₂ saturation may be outside the set limits before an alarm sounds.	Off , 10s, 25s, 50s, 100s
Color	Selects the SpO ₂ waveform color.	16 colors The default color is cyan.

* The factory default settings are in bold.

CAUTION

- **When using the High Sensitivity setting, performance of the "Sensor Off" detection may be compromised. If the device is in this setting and the sensor becomes dislodged from the patient, the potential for false readings may occur**

due to environmental "noise" such as light, vibration, and excessive air movement.

2. Tap the  icon to exit the **SpO₂** menu.

9.5.2 Configuring the SpO₂ Waveform

1. In the **Waveform** section of the **SpO₂** menu, select the options described in the following table.

Options	Description	Settings*
Speed	Selects the SpO ₂ pleth waveform speed.	6.25 mm/s, 12.5 mm/s , 25 mm/s
Display SIQ (Masimo only)	Selects whether or nor to show the Signal Index Quality (SIQ) in the SpO ₂ waveform area. The SIQ wave indicates the confidence associated with the saturation measurement and timing of the pulse. Higher pulse is a better signal.	On , Off

* The factory default settings are in bold.

2. Tap the  icon to exit the **SpO₂** menu.

9.5.3 Configuring SpO₂ Alarm Settings

You can change the SpO₂ and SpO₂ Desat alarm properties. You can also set whether to measure SpO₂ and NIBP simultaneously.

1. In the **Alarms** section of the **SpO₂** menu, select the options described in the following table.

Options	Description	Settings*
SpO ₂ Alarm Setup	Configures whether to switch on SpO ₂ and SpO ₂ Desat alarms. SpO₂ and Desat default to be switched on. After tapping SpO₂ or Desat you can configure alarm limits and alarm priority.	For SpO ₂ : Alarm switch: On , Off Alarm limit range: 0% to 100%; The default alarm upper limit is 100% . The default alarm low limit is 90%. Alarm Priority: Med , High
		For Desat: Alarm switch: On , Off Alarm limit range: Lower alarm limit is not higher than the SpO ₂ lower alarm limit. The default alarm low limit is 80% . Alarm Priority: High
NIBP Simul	When monitoring SpO ₂ and NIBP on the same limb simultaneously, you can switch on NIBP Simul to lock the SpO ₂ alarm status until the NIBP measurement ends. If you switch off NIBP Simul , low perfusion caused by NIBP measurement may lead to inaccurate SpO ₂ readings and therefore cause false physiological alarms.	On, Off

* The factory default settings are in bold.

2. Tap the  icon to exit the **SpO₂** menu.

9.6 SpO₂ Measurement

9.6.1 Identifying SpO₂ Modules

To identify which SpO₂ module you are using, see the company logo on the SpO₂ module.

- Masimo SpO₂ module is with a logo of Masimo SET.
- Nellcor SpO₂ module is with a logo of Nellcor.

9.6.2 Applying the Sensor

1. Select an appropriate sensor according to the module type, patient size, and weight.
2. Remove colored nail polish from the application site.
3. Apply the sensor to the patient.
4. Connect the sensor to the SpO₂ module and the SpO₂ module to the telemetry monitor.

The SpO₂ measurement displays when the telemetry monitor detects that a sensor is connected to the patient.

WARNING

- **When equipped with Masimo SpO₂ module, use only Masimo SpO₂ sensors specified in this manual. Use of other SpO₂ sensors may cause improper oximeter performance.**
 - **When equipped with Nellcor SpO₂ module, use only Nellcor SpO₂ sensors specified in this manual. Use of other SpO₂ sensors may cause improper oximeter performance.**
 - **If the sensor is too tight because the application site is too large or becomes too large due to edema, excessive pressure for prolonged periods may result in venous congestion distal from the application site, leading to interstitial edema and tissue ischemia.**
-
-

CAUTION

- Many patients suffer from poor peripheral perfusion due to hypothermia, hypovolemia, severe vasoconstriction, reduced cardiac output, etc. These symptoms may cause a loss in vital sign readings.
-

9.7 Understanding the SpO₂ Display

9.7.1 SpO₂ Digital Area

The SpO₂ digital area displays:

1. Parameter name
2. SpO₂ value
3. Perfusion indicator
4. Perfusion index (PI) label
5. Perfusion index value
6. SpO₂ unit of measure
7. PR measurement unit
8. PR value
9. Pulse rate (PR) label
10. Alarm high limit and low limit. When SpO₂ alarm is switched off, the activation state off icon  instead of alarm limits is displayed.

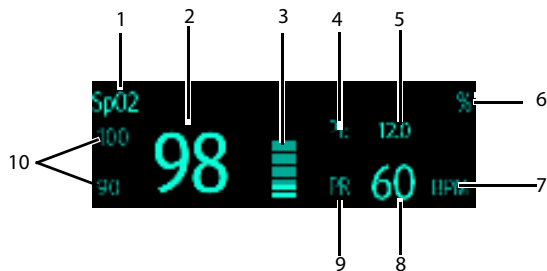

Masimo SpO₂ digital area



Nellcor SpO₂ digital area

9.7.2 About the SpO₂ Digital Area

- The SpO₂ digital area displays in units of % with a resolution of 1%.
- The SpO₂ PR value displays in units of bpm with a resolution of 1 bpm.
- Displays Masimo PI resolution as 0.01 when the PI value is smaller than 10%.
- Displays Masimo PI resolution as 0.1 when the PI value is greater than or equal to 10%.
- If the SpO₂ measurement or PR is invalid, "--" displays in place of digits.

9.7.3 SpO₂ Waveform Area

The SpO₂ waveform area displays:

1. Signal Index Quality (SIQ)
2. Area name
3. Pleth waveform



Masimo SpO₂ waveform area (SIQ enabled)

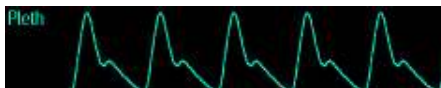

Nellcor SpO₂ waveform area

9.7.4 About the SpO₂ Waveform Area

- Displays in the configured SpO₂ color.

- Provides scrolling, real-time waveform data.
- Scrolls the waveform in the configured sweep speed.
- Automatically scales the SpO₂ waveform data area to maximize the vertical height of the Pleth waveform for the data range.
- If using Masimo SpO₂, the Signal Quality Index (SIQ) will display below the waveform if enabled.

9.8 Masimo Information



Masimo Patents

This posting serves as notice under 35 U.S.C. §287(a) for Masimo patents: <http://www.masimo.com/patents.htm>.

No Implied License

Possession or purchase of this device does not convey any express or implied license to use the device with unauthorized sensors or cables which would, alone, or in combination with this device, fall within the scope of one or more of the patents relating to this device.

9.9 Nellcor Information



Nellcor Patents

This posting serves as notice under 35 U.S.C. §287(a) for Covidien patents: <http://www.covidien.com/patents>.

No Implied License

Possession or purchase of this device does not convey any express or implied license to use the device with unauthorized replacement parts which would, alone, or in combination with this device, fall within the scope of one or more of the patents relating to this device.

10 Monitoring Noninvasive Blood Pressure (NIBP) (Optional)

10.1 Pairing Introduction

NIBP (non-invasive blood pressure) data is measured by BP10 using the oscillometric method. This measurement can be used for adult and pediatric patients.

You can connect a telemetry monitor to a BP10 via Mindray Patient Area Network (abbreviated as MPAN). The process of establishing connection between the telemetry monitor and the BP10 is called “pairing”.

When the telemetry monitor is paired with the BP10, measured NIBP data and NIBP-related technical alarms will be transferred from the BP10 to the telemetry monitor. You can view NIBP data and NIBP-related technical alarms and physiological alarms on the telemetry monitor’s screen.

For MPAN specifications, refer to **A.7.1 Mindray Patient Area Network (MPAN) Specification**. For the functionalities and operations of the BP10, refer to **BP10 NIBP Module Operator’s Manual**.

10.2 Pairing a Telemetry Monitor with a BP10

10.2.1 Pairing Procedures

Before pairing the telemetry monitor with a new BP10, first unpair the already connected BP10 by following steps in **10.3 Unpairing the Telemetry Monitor with the BP10**.

To pair a telemetry monitor with a BP10, follow this procedure:

1. Press the MPAN key on the right panel of the BP10. The “Pairing...” message will display in the prompt message area of the BP10.
2. Press the  key to enter the main menu of the telemetry monitor.
3. Tap **Wireless Modules**.
4. Tap **MPAN**, and then select **Connect to BP10**.

The telemetry monitor starts searching the BP10 devices in the vicinity and displays the devices that can be connected under **Devices**. Make sure that the device you wish to connect appears in the list of devices. If not, repeat Steps 1 to 4.

5. In the list of devices, select your desired device and tap **Connect**. Once the device is connected successfully, the status will be changed from **Disconnect** to **Connected**.

6. Tap anywhere in the NIBP parameter area on the telemetry monitor's main screen to access the **NIBP** menu.
7. Tap **Start** to start NIBP measurement. Verify that the NIBP measurement results displayed at the BP10 are consistent with that displayed on the main screen of the telemetry monitor and are the data for the same patient.

WARNING



- **Before pairing a BP10 with a new telemetry monitor, unpair it with the current telemetry monitor first.**
 - **Do not pair a telemetry monitor with an undesired BP10. If a telemetry monitor is paired with an undesired BP10, the patient category may be not applicable for the patient and the measured NIBP data may be incorrect.**
-
-

NOTE

- **Make sure that you have selected the correct BP10 to pair it with the telemetry monitor.**
 - **If you pair a telemetry monitor with a BP10 when NIBP measurement mode is set to ABPM at BP10, the system responses after successful pairing are slightly different from that when the NIBP measurement mode is set to Manual, Auto, or Sequence. For the differences, see 10.3.3 System Responses after Successful Unpairing.**
-
-

10.2.2 System Responses after Successful Pairing

Once a telemetry monitor is paired successfully with a BP10, the following system responses occur:

- The  icon will be changed to  in the top-right corner of the telemetry monitor's screen. Besides, the  appears in the top-right corner of the BP10.
- The status of the BP10 which is paired successfully with the telemetry monitor is displayed as **Connected**. Besides, the "Pairing Successful" displays in the BP10's message area for about 10 seconds.
- When NIBP measurement mode is set to **ABPM** at BP10 and the BP10 is paired successfully with the telemetry monitor, the wireless setup confirmation message "Select Yes to continue Patient in BP10. Select No to continue Patient in Telemetry" will display on the main screen of the telemetry monitor.
 - ◆ **Yes:** Patient-related settings comes from BP10 and ongoing NIBP measurement for current patient will not stop.
 - ◆ **No:** Patient-related settings at BP10 comes from the telemetry monitor. Besides, NIBP measurement for the patient monitored by BP10 will stop and the data history related to this patient will be cleared at BP10. When a BP10 in ABPM mode is not unpaired with a telemetry monitor and needs to be paired

with a new telemetry monitor, you must select **No**. Otherwise, chaotic patient data may occur.

- ◆ If neither **Yes** nor **No** is selected, the wireless setup confirmation message will disappear in three minutes. Besides, the “Pairing failure” message will be displayed in the prompt message area of the telemetry monitor. The “MPAN Disconnected” message is displayed in the message area of the BP10. In this case, follow steps in **10.2 Pairing a Telemetry Monitor with a BP10** to pair the telemetry monitor with the BP10 again.
- When NIBP measurement mode is set to **Manual**, **Auto**, or **Sequence** and the BP10 is paired successfully with the telemetry monitor, the wireless setup confirmation message “Select Yes to continue Patient in BP10. Select No to continue Patient in Telemetry.” will not be displayed. Patient-related settings from the telemetry monitor will be transferred to the BP10. But NIBP-related settings displayed on the main screen of the telemetry monitor will come from the BP10. The patient monitored by BP10 will be discharged automatically and the data history related to this patient will be cleared.
- Patient Category can be changed at the telemetry monitor only.
- A patient cannot be discharged from the BP10 and NIBP-related settings are grayed out at BP10. To discharge a patient from BP10, you need to unpair the BP10 from the telemetry monitor by following steps in **10.3 Unpairing the Telemetry Monitor with the BP10**.

10.3 Unpairing the Telemetry Monitor with the BP10

You can unpair the telemetry monitor with the BP10 either via the telemetry monitor or via the BP10.



10.3.1 Unpairing via the Telemetry Monitor

You can choose either of the two methods to unpair the telemetry monitor with the BP10 via the telemetry monitor.

Option 1:

1. Press the  key to enter the main menu of the telemetry monitor.
2. Tap **Wireless Modules**.
3. Select the device you wish to disconnect from the telemetry monitor from the devices list under **Devices**.
4. Tap **Disconnect**. The connected device is disconnected from the telemetry monitor.

When the telemetry monitor is unpaired with the BP10 successfully:

- The status of the BP10 unpaired will be displayed as **Disconnect** on the list of **Devices** at the telemetry monitor.
- The  icon will be changed to  in the top-right corner of the telemetry monitor's screen and of the BP10.

- Measured NIBP values on the main screen of the telemetry monitor is displayed as "--" indicating invalid values.
- The "MPAN Disconnected" message is displayed in the message area of the BP10.

Option 2:

1. Press the  key to enter the main menu of the telemetry monitor.
2. Tap **Wireless Modules**.
3. Tap **MPAN**,
4. Select **Off**.



10.3.2 Unpairing via the BP10

To unpair via the BP10, follow this procedure:

1. Press the MPAN key on the BP10.
2. Select **Yes** when the prompt message "Are you sure you want to close MPAN and unpair BP10?" appears.

10.3.3 System Responses after Successful Unpairing

Once a telemetry monitor is unpaired successfully with a BP10, the following system responses occur:

- The status of the BP10 connected previously will be changed to **Disconnect** under **Devices** on the telemetry monitor..
- The  icon will be changed to  in the top-right corner of the telemetry monitor's screen and of the BP10 .
- Measured NIBP values on the main screen of the telemetry monitor is displayed as "--" indicating invalid values.
- The "MPAN Disconnected" message is displayed in the message area of the BP10.

CAUTION

- **Before moving a telemetry monitor or BP10 to another area, unpair them first.**
 - **Before admitting a new patient at a BP10, you need to unpair it with a telemetry monitor first.**
 - **When the "MPAN Disconnected" message is displayed, medical staff should pay close attention to the patient's status.**
-

10.4 Screen Display after Pairing a Telemetry Monitor with a BP10

When a telemetry monitor is paired with a BP10 successfully, measured NIBP values will be displayed on the main screen of the telemetry monitor as shown in the following figure.

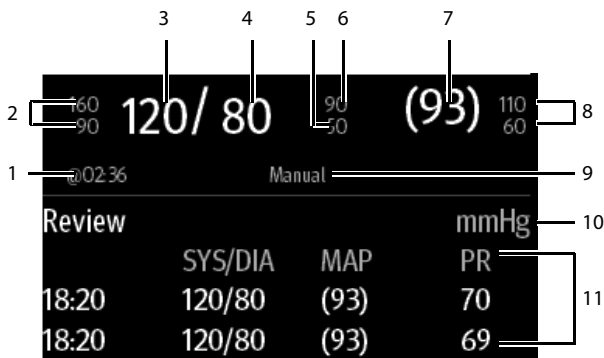

1. The last NIBP measurement time
2. Systolic pressure alarm limits
3. Systolic pressure
4. Diastolic pressure
5. Diastolic pressure low limit
6. Diastolic pressure high limit
7. Mean pressure (displayed after measurement is completed) or cuff pressure (displayed during measurement)
8. Mean pressure alarm limit
9. NIBP measurement mode: Manual, Auto, Seq., ABPM.
10. NIBP unit
11. NIBP measurement history area: displays NIBP measurement history information.

10.5 Interactions after Pairing a Telemetry Monitor with a BP10

10.5.1 Overview of Interactions

Once a telemetry monitor is paired successfully with a BP10, the interactions proceed as shown below.

Action	At the Telemetry Monitor	At the BP10
Start NIBP measurement	Yes	Yes
Stop NIBP measurement	Yes	Yes
Stop All NIBP measurements	Yes	Yes
NIBP STAT	Yes	Yes
Set initial pressure	Yes	No
Set NIBP measurement mode	Yes	No
Configure settings related to Auto measurement mode	Yes	No
Configure settings related to NIBP Sequence measurement mode	Yes	No
Set NIBP settings related to NIBP ABPM measurement mode	Yes	No
Set venipuncture	No	Yes
Set the cuff pressure for venipuncture	No	Yes

10.5.2 Operating the BP10 via the Telemetry Monitor

When the telemetry monitor is paired successfully with the BP10, you can enter the **NIBP** menu in either of the following ways:

- On the main screen, tap the NIBP digital area.
- Press the  key to enter the main menu → tap **Parameter Setup** → tap **NIBP**.

In the **Actions** section of the **NIBP** menu, you can:

- Tap **Start** to start NIBP measurement at the BP10.
- Tap **Stop** to stop an ongoing NIBP measurement at the BP10.
- Tap **Stop All** to cancel the series measurement in Auto, Sequence, or ABPM mode at the BP10.
- Tap **NIBP STAT** to start the series measurement in continuous mode at the BP10.

10.5.3 Configuring NIBP Settings

To configure NIBP settings, follow this procedure:

1. In the **Setup** section of the **NIBP** menu, select the options described in the following table.

Options	Description	Settings*
Mode	Configures NIBP measurement mode.	Manual, Auto, Seq., ABPM
Initial Pressure	Configures the initial cuff pressure.	For adult: 80 mmHg to 280 mmHg; the default is 160 . For pediatric: 80 mmHg to 210 mmHg; the default is 140 .
Color	Configures the color of NIBP numeric data.	16 colors The default color is white.

* The factory default settings are in bold.

10.5.4 Configuring NIBP Alarm Settings

To configure NIBP alarm settings, follow this procedure:

1. In the **Alarms** section of the **NIBP** menu, tap **NIBP Alarm Setup**.
2. Select the options described in the following table.

Options	Description	Settings*
SYS	Configures whether to trigger the NIBP systolic pressure alarm.	On, Off
		Alarm high limit: • For adult: Range: (low limit + 5) to 289 Default value: 160 • For pediatric: Range: (low limit + 5) to 239 Default: 120
		Alarm low limit: • For adult: Range: 26 to (high limit - 5) Default value: 90 • For pediatric: Range: 26 to (high limit - 5) Default: 70
		Alarm priority: Med, High

* The factory default settings are in bold.

Options	Description	Settings*
DIA	Configures whether to trigger the NIBP diastolic pressure alarm.	On, Off
		Alarm high limit: <ul style="list-style-type: none"> For adult: <p>Range: (low limit + 5) to 249 Default value: 90</p> For pediatric: <p>Range: (low limit + 5) to 199 Default: 70</p>
		Alarm low limit: <ul style="list-style-type: none"> For adult: <p>Range: 11 to (high limit - 5) Default value: 50</p> For pediatric: <p>Range: 11 to (high limit - 5) Default: 40</p>
		Alarm priority: Med, High
MAP	Configures whether to trigger the NIBP mean pressure alarm.	On, Off
		Alarm high limit: <ul style="list-style-type: none"> For adult: <p>Range: (low limit + 5) to 259 Default value: 110</p> For pediatric: <p>Range: (low limit + 5) to 214 Default: 90</p>
		Alarm low limit: <ul style="list-style-type: none"> For adult: <p>Range: 16 to (high limit - 5) Default value: 60</p> For pediatric: <p>Range: 16 to (high limit - 5) Default: 50</p>
		Alarm priority: Med, High

* The factory default settings are in bold.

Options	Description	Settings*
SYS Extreme	Configures whether to trigger the extreme NIBP systolic pressure alarm.	On, Off
		Alarm high limit: <ul style="list-style-type: none"> For adult: <p>Range: (SYS high limit + 5) to 290 Default value: 175</p> For pediatric: <p>Range: (SYS high limit + 5) to 240 Default: 130</p>
		Alarm low limit: <ul style="list-style-type: none"> For adult: <p>Range: 25 to (SYS low limit - 5) Default value: 75</p> For pediatric: <p>Range: 25 to (SYS low limit - 5) Default: 60</p>
		Alarm priority: High
DIA Extreme	Configures whether to trigger the extreme NIBP diastolic pressure alarm.	On, Off
		Alarm high limit: <ul style="list-style-type: none"> For adult: <p>Range: (DIA high limit + 5) to 250 Default value: 105</p> For pediatric: <p>Range: (DIA high limit + 5) to 200 Default: 80</p>
		Alarm low limit: <ul style="list-style-type: none"> For adult: <p>Range: 10 to (DIA low limit - 5) Default value: 35</p> For pediatric: <p>Range: 10 to (DIA low limit - 5) Default: 30</p>
		Alarm priority: High

* The factory default settings are in bold.

Options	Description	Settings*
MAP Extreme	Configures whether to trigger the extreme NIBP mean pressure alarm.	<p>On, Off</p> <hr/> <p>Alarm high limit:</p> <ul style="list-style-type: none"> For adult: Range: (MAP high limit + 5) to 260 Default value: 125 For pediatric: Range: (MAP high limit + 5) to 215 Default: 100 <hr/> <p>Alarm low limit:</p> <ul style="list-style-type: none"> For adult: Range: 15 to (MAP low limit - 5) Default value: 45 For pediatric: Range: 15 to (MAP low limit - 5) Default: 40 <hr/> <p>Alarm priority: High</p>

* The factory default settings are in bold.

NOTE

- For systolic pressure, diastolic pressure, or mean pressure, its alarm high limit should not be greater than the high limit of SYS Extreme, DIA Extreme, or MAP Extreme.
- For systolic pressure, diastolic pressure, or mean pressure, its alarm high limit should be at least 5mmHg greater than its alarm low limit.

11 Review

11.1 Introduction

You can review patients' history data on the tabular trends review page and the events review page.

11.2 Tabular Trends Review Page

The tabular trends review page displays trend data in a tabular form.

11.2.1 Entering the Tabular Trends Review Page

Enter the tabular trends review page in either of the following ways.

Option 1:

1. Press the  key to enter the main menu.
2. Tap **Review**.
3. Tap **Tabular Trends**.

Option 2:

Tap the **Tabular Trends** button in the upper right corner of the events review page.

For how to enter the events review page, refer to **11.3.1 Entering the Events Review Page**.

11.2.2 Example Tabular Trends Review Page

The latest trend data is displayed in the right most column. HR is always displayed in the first row. When you swipe your finger up or down the tabular trends, parameters and their trend data will be automatically moved up or down. The following figure is for reference only.

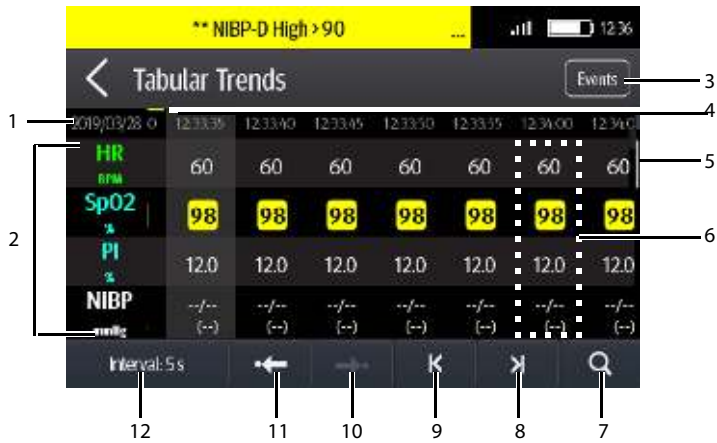





1. Current system date and trend data time. The interval of the trend data time is dependent on the option selected for **Interval**.
2. Digital area: displays numeric values at the cursor indicated time. The background color of numeric values indicates the alarm priority.
 - ◆ Red: high priority alarm event
 - ◆ Yellow: medium priority alarm event
 - ◆ Cyan: low priority alarm event
3. Events button: tapping this button goes to the events review page.
4. Event type indicator: different color blocks indicate different types of events:
 - ◆ Red: high priority alarm event
 - ◆ Yellow: medium priority alarm event
 - ◆ Cyan: low priority alarm event
 - ◆ Green: manual event
 - ◆ White: operation-related event such as system time change
5. Vertical bar: indicates the position of currently displayed parameters in all the parameters.
6. Highlighted column: indicates the trend data currently selected.
7. Search button: allows searching trend data within the specific time range.
8. Next page button: tapping this button moves to the right-most column of the review page.
9. Previous page button: tapping this button moves to the left-most column of the review page.

10. Next event button: tapping this button locates the next event.
11. Previous event button: tapping this button locates the previous event.
12. Interval setup button: tapping this button opens the **Interval** menu. For more information regarding this menu, refer to **11.2.4 Changing the Resolution of Trend Data**.

11.2.3 Example Tabular Trends Data Search Page

After you tap the  button on the tabular trends review page, the tabular trends data search page is displayed. The following figure is for reference only.



1. Timeline: indicates the entire time length
 - ◆ : indicates the time length of reviewable trend data.  can be moved within this time length.
 - ◆ : indicates no patient monitoring.  cannot be moved within this time length.
 - ◆ Different color blocks at the timeline indicate events of different types. See the color definition for the event type indicator.
2. Slider: indicates the position of current window time in the entire time length. Dragging the slider left or right enables you to locate the trend data at a specific time and also refreshes trend data in current window accordingly.

11.2.4 Changing the Resolution of Trend Data

1. Enter the tabular trends review page.
2. Tap **Interval** in the lower left corner of the review page.
3. Tap **Interval**.
4. Select the desired option.
 - ◆ **5 s or 30 s**: select to view up to 4 hours of tabular trends at an interval of 5 seconds or 30 seconds.
 - ◆ **1 min, 5 min, 10 min, 15 min, 30 min, 1 h, 2 h, 3 h**: select to view up to 48 hours of tabular trends at selected interval.
 - ◆ **NIBP**: select to view the tabular trends when NIBP measurements are acquired.

11.3 Events Review Page

The telemetry monitor stores events in real time, including the “MPAN Disconnected” technical alarm event, the “SpO₂ No Sensor” technical alarm event, physiological alarm events, manual events, and operational events.

NOTE

- **A total loss of power has no impact on the events stored.**
 - **Alarms are saved as events and will be maintained if the equipment is powered down. The time of equipment power down is not recorded as an event and cannot be reviewed.**
 - **Earlier events will be overwritten by later ones if the capacity is reached.**
 - **When the telemetry monitor is connected to the CMS, if events of the telemetry monitor are deleted from the CMS, they will not be deleted from the telemetry monitor and vice versa.**
-

11.3.1 Entering the Events Review Page

Enter the events review page in either of the following ways.

Option 1:

1. Press the  key to enter the main menu.
2. Tap **Review**.
3. Tap **Events**.

Option 2:

Tap the **Events** button in the upper right corner of the tabular trends review page.

NOTE

- Alarms are saved as events and will be maintained if the equipment is powered down. The time of equipment power down is not recorded as an event and cannot be reviewed.
- Earlier events will be overwritten by later ones if the storage capacity is reached.
- A total loss of power does not affect the events already stored.

11.3.2 Example Events Review Page

The events review page displays the list of events. Events are displayed in descending chronological order, with the most recent displayed at the top. The following figure is for reference only.



1. The position of current page in the total pages of events: for example, 39/56 indicates that there is a total of 56 pages of events and currently displayed events is on Page 39. You can swipe your finger up and down the screen to view other events.
2. Tabular trends button: tapping this button goes to the tabular trends review page.
3. Event overview area: provides an overview of the selected event
 - ◆ Event trigger time
 - ◆ Parameter value at the event trigger time. HR value is displayed when a physiological alarm is triggered.
 - ◆ Different color blocks are displayed on the left of each event to indicate different event types. For the meaning of each color block, refer to **11.2.2 Example Tabular Trends Review Page**.

- ◆ The number of asterisk symbols before an event indicate alarm priority as described in **6.3.3 Alarm Indicators**.

11.3.3 Example Event Details Page

After selecting the desired event overview area, you can view the event details.

- For manual events, you can view all the monitored waveforms 16 seconds before and after the event trigger time and all the measurement numerics at the event trigger time.
- For alarm events, you can view event-related waveforms 16 seconds before and after the event trigger time and all the measurement numerics at the event trigger time.

The following figure is for reference only.



The event trigger time is marked in a colored block along the timeline at the top of the event details page. Different color blocks indicate different types of events:

- Red: high priority alarm event
- Yellow: medium priority alarm event
- Cyan: low priority alarm event
- Green: manual event
- White: operation-related event

All the measurement numerics at the event trigger time are displayed at the bottom of the event details page. You can view these numerics by swiping your finger at the bottom of the main screen. The background color of numerics indicates the alarm priority.

- Red: high priority alarm event
- Yellow: medium priority alarm event
- Cyan: low priority alarm event

If you wish to return to the event list, tap the  icon.

This page intentionally left blank.

12 Configuring the Telemetry Monitor

12.1 Introduction

The **Maintenance** menu provides access to the system settings such as location, device name, alarm settings, quick keys, screen lock, and password updates. Entering this menu **requires** a passcode.

12.2 Entering the Maintenance menu

1. In the main menu, tap **Maintenance**.
2. Input the maintenance passcode.
3. Tap **Accept** to enter the **Maintenance** menu.

12.3 Configuring the General Menu

1. In the **Maintenance** menu, tap **General**.
The current setting displays to the right of the option.
2. Select the options described in the following table.

Options	Description	Settings*
Display Auto Off	Configures the time for display auto off.	1 min , 2 min, 5 min, 15 min 30 min, Off
Language	Configures the system language.	ENGLISH , FRENCH
Device Location	Changes the hospital ,department name, room number, and bed number. Refer to 12.3.1 Configuring Device Location for details.	N/A
Notch Filter	Configures the ECG Notch filter. This option is used to filter out AC line noise from the ECG waveform.	50 Hz, 60 Hz , Off The default is 50 Hz when the monitor is not configured for the US.
ECG Lead Labeling	Changes the ECG lead labeling.	AHA , IEC
Calibrate ECG	Enables or disables the ECG verification.	On, Off Refer to 17.6 Verifying the ECG for details.

* The factory default settings are in bold.

Options	Description	Settings*
SpO ₂ Module	Changes the SpO ₂ module.	Masimo SpO ₂ , Nellcor SpO ₂
SpO ₂ Tone	Configures the SpO ₂ tone.	Mode 1 , Mode 2
Date &Time	Configures the time format, date format, specific time, and date.	Time Format: 12Hr, 24 Hr Date Format: DD/MM/YY, YY/MM/DD , MM/DD/YY
Resp	This option is available only when the Resp functionality is supported. When it is supported and Resp is enabled, Resp numeric and waveform are displayed on the screen.	On, Off

* The factory default settings are in bold.

- Tap the  icon to exit the **General** menu.

NOTE

- Mindray recommends the same SpO₂ tone mode be used for the device within a monitoring area.**

12.3.1 Configuring Device Location

You can change device location and set whether to allow modifying a department name, room number, and bed number in the **Patient Info** menu.



To configure device location:

- In the **Maintenance** menu, tap **General**.
- Tap **Device Location**.
- Tap **Facility**.
- Enter the desired name.
- Tap **Department**.
- Select the desired option.
 - ◆ **Fixed:** you cannot modify **Department** in the **Patient Info** menu. **Department** is the one entered in the **Department** field of the **Device Location** menu.
 - ◆ **Unfixed:** you can modify **Department** in the **Patient Info** menu.
- Tap **Bed No./Room No**.
- Select the desired option.

- ◆ **Fixed:** you cannot modify **Room No.** and **Bed No.** in the **Patient Info** menu. **Room No.** and **Bed No.** are the ones entered in the **Room No.** and **Bed No.** fields of the **Device Location** menu.
- ◆ **Unfixed:** you can modify **Room No.** and **Bed No.** in the **Patient Info** menu.

12.4 Configuring the Alarms Menu

1. In the **Maintenance** menu, tap **Alarms**.
The current setting displays to the right of the option.
2. Select the options described in the following table.

Section & Options	Description	Settings*
Sounds		
Style	Allows an authorized user to set the alarm tone pattern.	ISO , Mode 1, Mode 2
Minimum Alarm Volume	<p>Allows an authorized user to configure the minimum alarm volume.</p> <p>The minimum alarm volume defines the minimum value you can set for the alarm volume.</p> <p>For example: If the minimum alarm volume is set to 5, the minimum value you can set for the alarm volume in the Audio Volume menu is 5 (as shown in the following figure).</p> <div style="text-align: center;">  </div> <p>If the minimum alarm volume is set to Off and the Sounds is set to 0, the alarm sound is turned off and the  symbol appears on the screen.</p>	Off, 1, 2 , 3, 4, 5, 6, 7, 8, 9, 10
Timeout		
Reminder Tone	<p>Allows an authorized user to enable or disable the reminder tone.</p> <p>If the alarm sound is turned off, enabling this setting can issue a periodic reminder tone.</p>	On , Off

* The factory default settings are in bold.

Section & Options	Description	Settings*
Reminder Interval	Allows an authorized user to configure the intervals between the alarm tones.	1 min, 2 min, 3 min, 5 min , 10 min
Technical Alarm Priority		
ECG Lead Off	Allows an authorized user to configure the alarm priority.	Low , Medium, High
SpO ₂ Sensor Off	Allows an authorized user to configure the alarm priority.	Low , Medium, High
Alarm Reset By Other Bed		
Alarm Reset By Other Bed	<p>Allows an authorized user to configure alarm reset permission for N series monitors.</p> <p>If this option is enabled, alarms of the telemetry monitor can be remotely reset on the N series monitor by performing alarm reset on the Remote View screen.</p> <p>Note: this option applies only to the scenario when the telemetry monitor and N series monitor are connected to the same CMS.</p>	On, Off

* The factory default settings are in bold.

3. Tap the  icon to exit the **Alarms** menu.

WARNING

- **When Minimum Alarm Volume is set to Off and Sounds is set to 0, alarm sound is turned off, the telemetry monitor will not enunciate alarms when they occur. Be careful when turning off the alarm sound.**
 - **Do not rely exclusively on the audible alarm system for monitoring. Adjustment of alarm volume to a low level may result in a hazard to the patient.**
-
-

12.5 Quick Keys Menu

12.5.1 Changing the Quick Keys

1. In the **Maintenance** menu, tap **Quick Keys**.
The **Quick Keys** configuration menu displays.

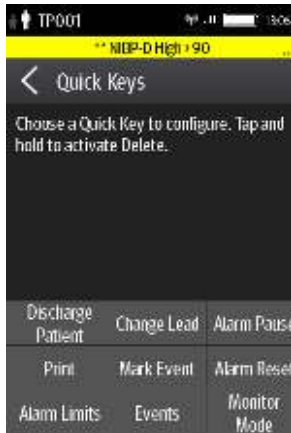

2. From the quick keys area at the bottom of the screen, tap a quick key you want to configure.
A list of options displays.

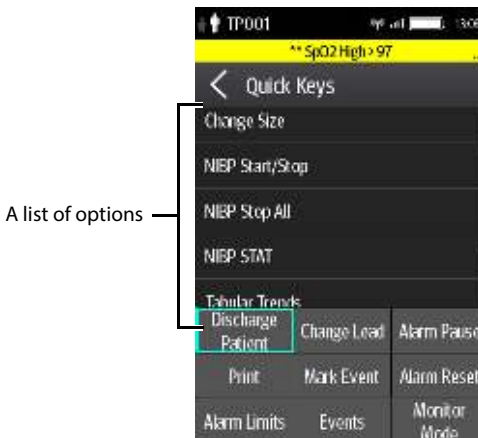

3. Tap the desired option from the list of options to configure the selected quick key.

4. Repeat steps 2 to 3 to configure other quick keys, if needed.
5. Tap the  icon to exit the **Quick Keys** menu.

12.5.2 Deleting a Quick Key

1. From the quick keys area at the bottom of the **Quick Keys** menu, press and hold the desired quick key for two seconds, and then release it.
The quick key background turns to red and displays **Delete**.
2. Tap **Delete**.
The quick key is removed from the quick keys area, and the area displays **Not Used**.
3. Tap the  icon to exit the **Quick Keys** menu.

12.6 Configuring the Defaults Menu

The **Defaults** menu allows an authorized user to manage the system configurations.

1. In the **Maintenance** menu, tap **Defaults**.
2. Select the options described in the following table.

Options	Description	Settings*
Save Departmental Defaults	Allows an authorized user to save the current device settings for the selected patient category.	N/A
Export Device Settings	Copies the current settings to the external device.	N/A
Import Device Settings	Copies the settings from the external device to the telemetry monitor unit. Refer to 12.6.1 Transferring a Configuration for details.	N/A
Restore Factory Defaults	Allows an authorized user to reestablish the original database power up settings to factory default values.	N/A
Default Patient Category	Allows an authorized user to set default patient category for the newly admitted patient. If it is set as Remain , the default patient category for the newly admitted patient is the same as the last discharged patient.	Adult , Pediatric, Remain

* The factory default settings are in bold.

3. Tap the  icon to exit the **Defaults** menu.

12.6.1 Transferring a Configuration

You can copy some configurations of one TM70 to another TM70 via the MPAN functionality. The following takes the example of transferring the configurations from TM70 A to TM70 B.

To transfer the configuration from the telemetry monitor A to telemetry monitor B:

1. In the **Maintenance** menu of telemetry monitor B, select **Defaults** → **Import Device Settings** to enter the settings import mode.
2. In the **Maintenance** menu of the telemetry monitor A, select **Defaults** → **Export Device Settings** to enter the **Export Device Settings** menu.

The external device (telemetry monitor B in this example) found is listed in the **Export Device Settings** menu.

3. Select the desired external device (telemetry monitor B in this example) by tapping the check box.
4. Tap **Export** to start exporting the telemetry monitor A's configurations.

The "Downloading device settings" message will be shortly displayed on the telemetry monitor B's screen.

WARNING

- **Do not power off the devices during the download process.**
- The  symbol displays at the top of the screen while transferring a configuration.
- **When telemetry monitor is connected to the CentralStation, *Import Device Settings* would not work. To use *Import Device Settings*, telemetry monitor should not be connected to CentralStation.**

- If an import is successful, the "Download complete." message will be displayed on the telemetry monitor B's screen. The screen returns to the **Defaults** menu in 10 seconds. The "Complete" message will be displayed on the telemetry monitor A's screen.
- If the import fails, the "Import attempt failed." message will be displayed on the telemetry monitor B's screen. The "Failure" message will be displayed in the prompt message list of telemetry monitor A's screen.

You have two options when a failure occurs:

- ◆ To stop the import from telemetry monitor A, tap the  icon at telemetry monitor B to exit the **Import Device Settings**.

- ◆ To retry the import from the telemetry monitor A, tap the external devices where the “**Failure**” message is displayed and tap the **Retry** button to restart the transfer.

You may need to repeat the retry operation several times until the transfer is successful.

12.7 Screen Lock Menu

12.7.1 Understanding the Screen Lock Mode

There are two modes of being able to lock the screen to assist in preventing unauthorized use. Each mode allows the user access to certain features of the product without entering a passcode. When the correct passcode is entered, all features are available.

- Locked Mode Features:
 - ◆ Main screen and main menu are not accessible without passcode entry.
 - ◆ The message area is still viewable.
 - ◆ Hardkeys are enabled.
- View Only Features:
 - ◆ Upon powering up, the main screen will be displayed after the new patient choice is made.
 - ◆ Main Screen is accessible without passcode entry.
 - ◆ The **System Info** menu is accessible by tapping the battery symbol on the main screen.
 - ◆ The **Lead Placement** menu is accessible by tapping an “ECG Sensor Off” message in the alarm area.
 - ◆ Ability to change display orientation.
 - ◆ Hardkeys are enabled.

12.7.2 Setting the Screen Lock

The initial enabling of screen lock mode requires a passcode to be entered immediately as follows:

1. In the **Maintenance** menu, tap **Screen Lock** to select a screen lock mode.
2. Enter a new passcode for the screen lock.

After the passcode is entered, the screen exits the passcode setup menu. The selected lock mode displays to the right of **Screen Lock**.

12.7.3 Changing the Current Screen Lock Passcode

1. In the **Maintenance** menu, tap **Screen Lock**.

2. Tap **Screen Lock Passcode**.
3. Input the current password.
4. Input and verify the new password

12.7.4 Changing the Screen Lock Mode

Follow this procedure to change the screen lock:

1. In the **Maintenance** menu, tap **Screen Lock** to choose a screen lock mode.
2. Select your desired screen lock mode and then enter a passcode.

12.8 Changing the Passwords

1. In the **Maintenance** menu, tap **Edit Passwords**.
 - ◆ Tap **Maintenance Password** and follow the on-screen instructions to change the maintenance password.
 - ◆ Tap **Service Password** and follow the on-screen instructions to change the service password.
2. Tap the  icon to exit the **Edit Passwords** menu.

12.9 Changing the Device Name

1. In the **Maintenance** menu, tap **Device Name**.
2. Use the on-screen keyboard to input the device name.
3. Tap **Accept** to save the setting and exit the **Device Name** menu.

NOTE

-
- **Do not set the same device name for the TM70s.**
-

12.10 Auto Enter Monitor Mode

12.10.1 Understanding Auto Enter Monitor Mode

Auto Enter Monitor Mode allows the telemetry monitor to switch from telemetry mode to monitor mode when **No Central Monitoring** or **Lethal Arrhy. Alarm** occurs. In this case, the display turns from off to on and medical staff should pay more attention to the patient's status. If the above alarm disappears, the telemetry monitor switches back to telemetry mode and the display turns off when the configured **Display Auto Off** time has elapsed.

12.10.2 Configuring Auto Enter Monitor Mode

By default, **Auto Enter Monitor Mode** is set as **No Central Monitoring**.

To configure **Auto Enter Monitor Mode**, follow this procedure:

1. In the **Maintenance** menu, tap **Auto Enter Monitor Mode**.
2. Choose the desired option:
 - ◆ **No Central Monitoring:** When disconnected from the CMS, the telemetry monitor switches from telemetry mode to monitor mode and displays no central monitoring alarm.
 - ◆ **Lethal Arrhy. Alarm:** When lethal arrhythmia alarm occurs, the telemetry monitor switches from telemetry mode to monitor mode and displays lethal arrhythmia alarm.
 - ◆ Both **No Central Monitoring** and **Lethal Arrhy. Alarm** are selected: When disconnected from the CMS or lethal arrhythmia occurs, telemetry monitor turns from telemetry mode to monitor mode and displays corresponding alarm.
3. Tap the icon  to exit the **Auto Enter Monitor Mode** menu.

NOTE

- **When the telemetry monitor is connected to the CMS, Auto Enter Monitor mode can only be configured on the CMS. The configuration is synchronized to the telemetry monitor.**
 - **The telemetry monitor switches back to telemetry mode only when all the abnormal conditions that trigger auto enter monitor mode disappear.**
 - **If you already choose monitor mode via the telemetry monitor or CMS, the auto enter monitor mode would be ineffective.**
 - **If the telemetry monitor is paired with a N series monitor and the N series monitor is in standby, the telemetry in monitor mode, then the auto enter monitor mode would be ineffective.**
 - **For details about configuring the Display Auto Off time, refer to 3.7.6 Turning the Display Off.**
-
-

WARNING

- **When No Central Monitoring is disabled, the medical staff should pay more attention to the patient's status and check the telemetry monitor's network connection status at the CMS. When the offline alarm is displayed on the CMS, medical staff should check the patient's status immediately.**
 - **When Lethal Arrhy. Alarm is disabled, the medical staff should also pay more attention to the patient's status.**
-
-

12.11 Using with a Patient Monitor

You can connect a telemetry monitor (hereinafter called the telemetry) with the N series monitor (hereinafter called the monitor) to measure the ECG, Resp, SpO₂, and NIBP of ambulatory adult and pediatric patients. The process of connecting the telemetry and the monitor is called "pairing".

The pairing should be done mainly on the N series monitor, please refer to the operator's manual of the N series monitor.

12.11.1 Confirm the Pairing of the Telemetry and the Monitor

When "This telemetry is pairing with patient monitor XX, are you sure?" prompts on the display of the telemetry during pairing, select **Yes** to continue.

After pairing with the telemetry, on the monitor, labels of parameters from the telemetry are followed by "-T", for example ECG-T, indicating that these parameters come from the telemetry.

12.11.2 Unpair the Telemetry with the Monitor

To unpair the telemetry and the monitor from the telemetry, follow this procedure:

1. Press the main menu button  on the front panel of the telemetry.
2. If prompted, input the password for the screen lock dialog. When **Screen Lock** is set to **Off**, skip this step.
3. Select **Unpair**.
4. Select which device is used to continue monitoring the patient.
 - ◆ **Telemetry**: the telemetry is used to continue monitoring the patient. Patient is discharged from the monitor and the monitor enters standby.
 - ◆ **Monitor**: the monitor is used to continue monitoring the patient. Patient is discharged from the telemetry and the telemetry enters standby.
 - ◆ **Cancel**: do not unpair the telemetry and the monitor.

12.12 Demo Mode

Allows an authorized user to choose a demonstration mode for in-servicing staff or testing product features.

12.13 Service Menu

Allows an authorized user access to the passcode protected Service menu.

WARNING

- **If you enter Survey menu when the telemetry monitor is connected to the central monitoring system, all the alarms triggered in the telemetry monitor will be neglected, not displayed or reported by the monitor.**
-
-

13 Monitoring with the Telemetry Monitor at the CMS

13.1 Introduction

This chapter only describes the operations that you need to perform at the CMS. For common operations such as how to set alarms and parameter settings at the CMS, refer to ***BeneVision Central Monitoring System Operator's Manual***.

When the telemetry monitor is successfully connected to the CMS:

- The telemetry monitor transmits parameter values, waveforms, alarm settings, and events to the CMS. From the CMS, you can check the patient's monitoring data and alarms.
- Patient information, alarm settings, alarm status, and parameter settings can be synchronized between the telemetry monitor and the CMS.
- The telemetry monitor's screen is off.
- The CMS will automatically send configurations to the telemetry monitor under the following circumstances:
 - ◆ The telemetry monitor is connected to the CMS for the first time.
 - ◆ User configurations are saved at the telemetry monitor.
 - ◆ The telemetry monitor is connected to a different CMS.
 - ◆ After configurations are sent, configurations are saved again at the CMS, or
 - ◆ The department is modified at the telemetry monitor and corresponding department configurations are available at the CMS.

The configurations will be saved as user configurations at the telemetry monitor. They will be automatically loaded when a patient category is changed or a patient is discharged at the telemetry monitor.

When the TM70 is disconnected from the CMS and then re-establishes connection to the CMS, it can send the following data which was not received by the CMS during the time of connection loss.

- Up to most recent 24 hours of tabular trends for all parameters at the trend interval equal to or greater than 1 minute.
- Up to 200 events without waveforms
- Up to 10 seconds of full disclosure waveforms of ECG I, II, III, and V/Va leads.

WARNING

- It is not recommended to assign a telemetry monitor to a department in the Configuration tab of the CMS.
-
-

13.2 Network Safety Information

CAUTION

- Wireless network designing, deploying, debugging, and maintenance should be executed by Mindray service personnel or authorized technicians.
 - Always set the wireless network according to local wireless regulations.
 - Keep network authentication information, for example password, safe, protecting the network from being accessed by unauthorized users.
 - Do not connect non-medical devices to the monitor network.
 - If wireless network signal is poor, there may be a risk of CMS data loss.
 - RF interference may result in wireless network disconnection.
 - Disconnecting from the network may result in CMS data loss and function failure. Check the patient in case of network disconnection and solve the network problem as soon as possible.
-

13.3 Adjusting the Minimum QRS Detection Threshold

To avoid false asystole alarms when the R wave amplitude is low and missed asystole alarms during ventricular standstill (tall P waves, but no QRS), a means to manually adjust the minimum QRS detection threshold is provided.

To adjust the QRS detection threshold, follow this procedure:

1. On the ViewBed screen of the CMS, select the ECG digital area or waveform area to enter the **ECG** menu.
2. From the **ECG** tab, select the **QRS Threshold** section.
3. Select the arrow buttons to adjust the QRS threshold. Selecting **Defaults** resets the QRS threshold to the default value (0.16 mV).

CAUTION

- The setting of QRS threshold can affect the sensitivity of arrhythmia, ST, QT/QTc detection, and heart rate calculation.

- **If QRS amplitude is low, the telemetry monitor might not be able to calculate heart rate and false asystole may occur.**
-

13.4 Setting the Analysis Leads

By default, the equipment uses the first two ECG waveforms displayed on the screen (ECG1 and ECG2) as analysis leads for heart rate calculation and arrhythmia detection. To set the analysis lead, follow this procedure:

1. At the CMS, select **System Setup** → input the password → select **OK**.
2. In the **System Setup** menu, select the **Telemetry** tab → input the password → select **OK**.
3. Select **Analysis Leads**.
4. Set **Analysis Leads**:
 - ◆ **On**: you can select analysis leads.
 - ◆ **Off**: ECG1 and ECG2 are used as analysis leads.

When **Analysis Leads** is set to **On**, you can select which leads are used as analysis leads. To do so, follow this procedure:

1. Select the ECG numeric area or waveform area to enter the **ECG** menu.
2. Select the **Analysis Leads** tab.
3. Select the desired leads as analysis leads.

NOTE

- **When a 3-lead ECG cable is used, the monitor always uses single lead as analysis lead and the Analysis Leads option is not available.**
-

13.5 QT Monitoring

A normal ECG waveform (as shown in the following figure) typically includes a sharp and well defined QRS complexes with consistent spacing between R waves, and an ECG baseline that is free of noise and artifact.

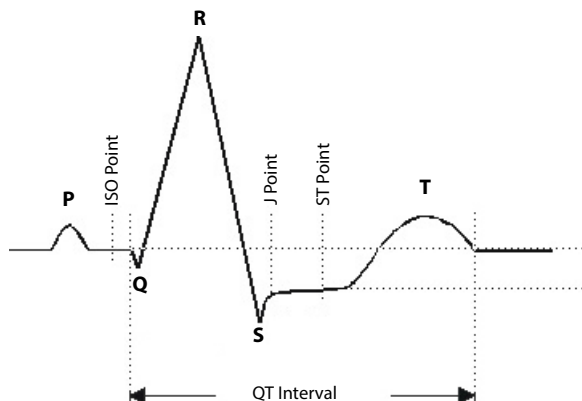

A normal ECG waveform (for QT monitoring)

The QT interval in an ECG lead is the time interval from the onset of the earliest deflection in the QRS complex to the end of the T wave. QT monitoring can assist in the detection of prolonged QT interval syndrome.

13.5.1 Changing the QTc Formula

The CMS uses the Hodges correction formula by default to correct the QT interval for heart rate. The QTc formula can be changed in the **System Setup** menu. For how to change the QTc formula, refer to ***BeneVision Central Monitoring System Operator's Manual***.

13.5.2 QT View

In the **QT View** menu, you can view a snapshot of the real-time wave and to verify that the QT algorithm detects correct Q and T points.

13.5.2.1 Entering the QT View

To enter the **QT View** menu, follow this procedure:

1. On the ViewBed screen of the CMS, select the ECG digital area or waveform area to enter the **ECG** menu.
2. Select the **QT** tab.
3. Select **QT View** at the bottom of the **QT** menu.

The **QT View** menu displays, as shown in the following figure:

- The current waveform and parameter values display in green.
- The template waveform and parameter values display in white.
- The Q and T points are marked with a vertical line.

- The Δ QTc value is equal to the current QTc value minus the template QTc value.
- In some conditions, no QT measurement can be calculated. Then the cause of failed QT measurement is shown at the bottom of the QT digital area and the message "Cannot Analyze QT" is shown in the technical alarm area.



QT View menu

13.5.2.2 Configuring the QT View

To configure the QT view, follow this procedure:

1. Enter **QT View**.
2. Select the buttons described in the following table as desired.

Buttons	Description	Settings*
Left or right arrow	Select the desired lead to display on the QT View menu screen by selecting the left or right arrow.	II, I, III, aVR, aVL, aVF, V Note: the leads here serve as an example only. They depend on the Lead Set selected.
Set Baseline	Set an ST baseline when ST values become stable.	None
	The ST template updated time displays at the bottom of the screen.	
Hide Baseline	Hides the reference baseline.	None

* The factory default settings are in bold.

NOTE

- The display of the QT digital area differs as related settings change.

13.6 ST Monitoring

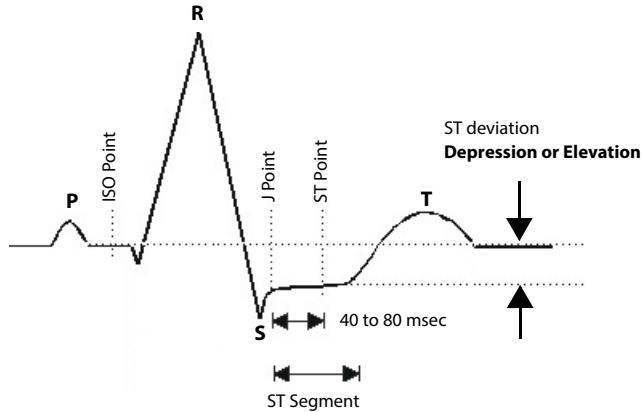

A normal ECG waveform (for ST monitoring)

The ST segment of an ECG waveform (as shown in the above figure) represents the period from the end of ventricular de-polarization, to the beginning of ventricular re-polarization, or the end of the QRS complex (the J point) and the beginning of the T-wave. ST Segment analysis is used to monitor the oxygen supply and the viability of the heart muscle.

ST deviation is the vertical distance between the isoelectric (ISO) point level and signal level at ST point.

The ISO point is located between the end of the P-wave and the onset of the QRS complex. The ISO point provides the baseline for this measurement.

The ST point is a fixed distance from the J point at the end of the QRS complex. The ST point can be configured to 40, 60, or 80 milliseconds past the J-point, independent of the heart rate. By default, the ST point is positioned as follows:

- at 80 milliseconds for heart rates less than or equal to 120 beats per minute
- at 60 milliseconds for heart rates greater than 120 beats per minute

All available ECG leads are analyzed to measure deviations in the ST segment.

Selecting leads that contain the least amount of baseline flutter will improve measurement accuracy, but accurate ST deviation measurement is dependent on the correct location of the ISO and ST points.

- ST segment analysis calculates ST segment elevations and depressions for individual leads and then displays them as numerics in the ST digital area.
- A positive value indicates ST segment elevation; a negative value indicates ST segment depression.

WARNING

- **The ST algorithm has been tested for accuracy of the ST segment data. The significance of the ST segment changes need to be determined by a clinician.**
 - **ST deviation is often calculated at a fixed offset from the J point. Changes in heart rate may affect ST.**
-
-

13.6.1 Adjusting ST Measurement Points

The ISO and ST points need to be adjusted when you start monitoring and if the patient's heart rate or ECG morphology changes significantly. Exceptional QRS complexes are not considered for ST-segment analysis.

WARNING

- **Always make sure that the ST measurement points are appropriate for your patient.**
-
-

To adjust ST measurement points, follow this procedure.

1. On the ViewBed screen of the CMS, select the ECG digital area or waveform area to enter the **ECG** menu.
2. Select the **ST** tab.
3. Select the **Adjust** section.
4. Set **ST Point**.
5. Enable or disable **Auto Adjust**. This option defines the method of adjusting the ISO point and J point.
 - ◆ Enabled: It is enabled by default. In this case, positions of ISO point and J point are automatically adjusted accordingly.
 - ◆ Disabled: you need to manually adjust the position of ISO point and J point by selecting the arrows at the right sides of ISO and J.

13.6.2 Entering the ST Graphic Window

To enter the ST graphic window, follow this procedure.

1. On the ViewBed screen of the CMS, select the ECG digital area or waveform area to enter the **ECG** menu.

2. Select the **ST** tab to enter the **ST** menu.
3. From the bottom of the ST menu, select **ST Graphic**.

The height of the bar indicates the ST value of corresponding ST lead. The color of the bar indicates ST alarm status: green indicates that corresponding ST value is within alarm limits; cyan, yellow and red indicate that the ST value exceeds the alarm limits. The color matches ST alarm priority.

The height of gray bar indicates the baseline ST value and the green bar (cyan, yellow or red if an alarm occurs) indicates Δ ST.

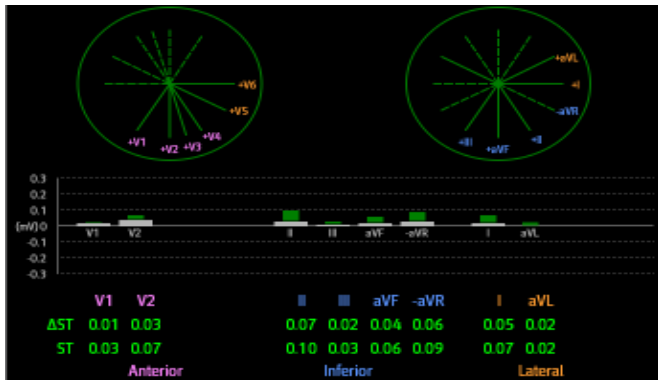

13.6.3 Entering the ST View

The ST View shows a complete QRS segment for each ST lead. The color of current ST segments and ST values is consistent with the color of ECG waveforms, normally green. The color of baseline ST segments and ST values is white.

To enter the ST View, follow this procedure:

1. On the ViewBed screen of the CMS, select the ECG digital area or waveform area to enter the **ECG** menu.
2. Select the **ST** tab to enter the **ST** menu.
3. From the bottom of the menu, select **ST View**.
4. Set the desired items.

Buttons	Description	Settings*
Set Baseline	Set an ST baseline when ST values become stable.	None
	The ST template updated time displays at the bottom of the screen.	

Buttons	Description	Settings*
Display/Hide Baseline	Displays or hides the reference baseline.	None
Display/Hide Marker	Displays or hides the position of ISO point, J point and ST point.	

13.7 Arrhythmia Monitoring

13.7.1 Configuring the PVC-Related Alarm Threshold

PVC-related alarms are detected on the basis of the current ventricular heart rate and the number of consecutive PVCs.

To configure the threshold of PVC-related alarm threshold, follow this procedure:

1. On the ViewBed screen of the CMS, select the ECG digital area or waveform area to enter the **ECG** menu.
2. Select the **Arrhythmia** tab.
3. Select the **More Threshold** section.
4. Set the desired items using the right or left arrow.

The following figure illustrates the conditions under which PVC alarms will be generated if **V-Tach PVCs** is set to 6, **V-Tach Rate** is set to 130, **V-Brady PVCs** is set to 5, and **V-Brady Rate** is set to 40.

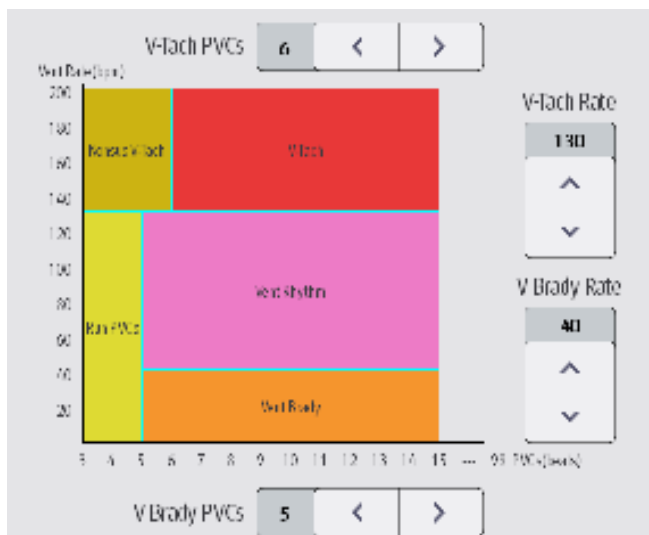

If both V-Tach PVCs and V-Tach Rate are greater than or equal to the limits, a V-Tach alarm is generated.

- If consecutive PVCs is lower than the V-Tach PVCs limit (6) but greater than 2, and the Vent rate is greater or equal to the V-Tach Rate limit (130), a Nonsus V-Tach alarm is generated.
- If consecutive PVCs is greater than or equal to the V-Brady PVCs limit (5), and the Vent rate is lower than the V-Brady limit (40), a Vent Brady alarm is generated.
- If both the V-Brady PVCs and V-Brady Rate are lower than the limits, but V-Brady PVCs is greater than 2, a Run PVCs alarm is generated.
- If the V-Brady PVCs and V-Brady Rate are greater than or equal to limits, but the Vent rate is lower than V-Tach Rate (130), a Vent Rhythm alarm is generated.

13.7.2 Configuring the Arrhythmia Shield Time

To configure arrhythmia shield time, follow this procedure:

1. Select the system menu area  in the upper left corner of the CMS screen.
2. Select **System Setup** to access the **System Setup** menu.
3. Select the **Telemetry** tab.
4. Select the **Alarm** Tab.
5. Set **Arrhy Shield Time**. When it is set to **0**, it indicates that the alarm shield function is disabled.

13.8 Locating the Telemetry Monitor

If the AP70 information of the TM70 has been imported into the CentralStation, you can view device location information for TM70 telemetry monitors. For details on how to import AP70 information, see ***BeneVision Central Monitoring System Operator's Manual***.

To view device location, follow this procedure:

1. Select the  symbol at the top of the ViewBed screen. The **Device Location** menu is displayed.
2. View the AP70 switch time in the **Time** column and the current location of devices in the **Location** column.
3. If you wish to locate a TM70 telemetry monitor, select the **Find Device** button. The TM70 will generate a continuous audible tone until it is acknowledged at the TM70.

WARNING

- Because the coverage range of Access Points can sometimes overlap, including different floor levels, the Device Location feature is not intended for use when attempting to locate a patient.
-
-

NOTE

- Find Device requires that the telemetry monitor has sufficient battery power and is within the coverage area.
-

13.9 Sending a Notification to the Telemetry Monitor

You can send a notification to the telemetry monitor to remind a patient to perform certain activity such as taking medicine.

To send a notification, follow this procedure:

1. On the ViewBed screen of the CMS, select the **Send Message**  quick key from the quick key area.
2. Enter a notification into the pop-up window.
3. Select **Send**. This message will be sent to the corresponding telemetry monitor and displayed on the main screen of this telemetry monitor.
4. If you wish to confirm the notification, tap **Confirm** at the telemetry monitor.

13.10 Triggering an Alarm Reminding Patients' Location

You can enable the functionality of triggering an alarm when patients enter or move out of the restricted area at the CMS.

After the functionality is enabled, when a patient enter or move out of the restricted area, the "Out of the allowed area " alarm will be triggered at the telemetry monitor.

To enable the functionality, follow this procedure:

1. Select the system menu area  in the upper left corner of the CMS screen.
2. Select **System Setup** to access the **System Setup** menu.
3. Select the **Network** tab.
4. Select the **AP Management** tab.
5. In the **Patient Movement Area Setup** section, configure **Setup Mode** and **Department**.
6. If you need to specify an AP70 location, enter the desired AP70 location in the **Please input location information** field. If you wish to select all the locations, select **Select All**.

7. Enable or disable **Trigger an alarm when patients enter the restricted area** or **Trigger an alarm when patients move out of the allowed area**. This option is dependent on **Setup Mode**.
8. Select **Alarm Priority**.

When the “Out of the allowed area” alarm is triggered, check patient’s location and tap **Confirm** at the telemetry monitor.

13.11 Setting Authorization

You can set whether to allow the following settings on the telemetry monitor. By default, these settings are allowed and not password protected:

- Change alarm setup and arrhythmia setup
- Pause and reset alarm
- Enable ST and QT analysis
- Manually start ECG Relearn
- Modify patient demographics
- Discharge patient and enter standby

To set the permission, follow this procedure:

1. Select the system menu area  in the upper left corner of the CMS screen.
2. Select **System Setup** to access the **System Setup** menu.
3. Select the **Telemetry** tab → **Authorization Setup**.
4. Select the desired option:
 - ◆ **No Password:** the setting is allowed and not password protected on the telemetry monitor.
 - ◆ **Read Only:** the setting can only be viewed on the telemetry monitor.
 - ◆ **User Password:** the user name and password saved in the MLDAP server are required for the setting on the telemetry monitor. If the telemetry monitor is disconnected with the CMS, the maintenance password of the telemetry monitor will be required.

NOTE

-
- **User Password permission is only available for changing alarm setup and arrhythmia setup, pausing and resetting alarms.**
-

14 Battery

14.1 Introduction

The telemetry monitor can be powered by a lithium-ion rechargeable battery pack or AA batteries. This chapter provides instructions on how to use, maintain, and dispose of the batteries.

14.2 Safety

WARNING

- **Keep the batteries out of children's reach.**
- **Keep the batteries in their original package until you are ready to use them.**
- **Make sure to install the lithium-ion battery pack or the AA battery tray and close the battery compartment during defibrillation.**
- **Only use recommended AA batteries or rechargeable lithium-ion battery to power the telemetry monitor. Other power supply may cause damage to the equipment or lead to body injury.**
- **While installing AA batteries, do not apply reverse polarity.**
- **Only use recommended fresh AA batteries. Using other AA batteries can give unacceptable performance.**
- **Do not mix batteries of different charge/voltage levels.**
- **Do not mix batteries of different chemistries.**
- **Only use specified rechargeable lithium-ion battery. Unspecified lithium-ion battery can give unacceptable performance.**
- **If a battery shows signs of damage or signs of leakage, replace it immediately. Use caution in removing the battery. Avoid contact with skin. Refer to qualified service personnel.**
- **Some failure conditions, such as short circuits, can cause a battery to overheat during using. High temperature can cause burns to the patient or user. If the device becomes too hot to the touch, remove it from the patient and place aside until it cools. Then remove the battery from the device, and contact your service personnel to identify the cause of overheating.**
- **Replace the battery immediately once the "Critically Low Battery" alarm message displays. Replace the battery in time once the "Low Battery" alarm message displays. If those conditions are not corrected, device shutdown and**

cessation of monitoring will result. After replacing the rechargeable lithium-ion battery, charge it in time. Do not store the lithium-ion battery whose batter power is depleted but is not charged yet.

- **To eliminate the risk of electrical shock or burn, do not carry loose batteries on your person, such as placing the battery in clothing pockets.**
- **Use caution when handling the lithium-ion rechargeable battery pack. Misuse or abuse may cause bodily injury or device damage.**
 - ◆ Do not short circuit. Take care that the terminals do not contact metal or other conductive materials during transport and storage.
 - ◆ Do not crush, drop or puncture the battery. Mechanical abuse can lead to internal damage and internal short circuits. If a battery has been dropped or banged against a hard surface, whether damage is externally visible or not, remove the battery from use and dispose of it properly.
 - ◆ Do not incinerate batteries or expose them to temperatures above 60°C (140°F).
- **The rechargeable lithium-ion batteries should be charged in the specified central charger.**

CAUTION

- **Remove the battery before transporting the device or if the device is not in use or is being stored.**
- **The telemetry monitor cannot be used for monitoring if the battery compartment is wet. Remove the batteries and wipe the compartment dry before continued monitoring.**
- **AA batteries should be removed from the device at the end of the battery's useful life to prevent leakage. In case of battery leakage, use caution to remove the batteries and clean the battery compartment. Install fresh AA batteries and check if the telemetry monitor can power on properly. If the telemetry monitor fails to power on, contact your service personnel.**

NOTE

- **Batteries of different types may give different performance such as battery runtime and insufficient battery low or critically low warning time.**
 - **When the telemetry monitor is not powered off, if you remove batteries, patient data measured within one minute before the battery removal will be lost.**
-

14.3 Installing the Battery

Refer to **3.4 Installing the Batteries** for details.

14.4 Checking the Battery Charge Status

The battery symbol displaying on the top of main screen indicates the battery charge status. The white part () indicates the remaining battery charge.

NOTE

- If the “Low Battery” or “Critically Low Battery” alarm occurs, the telemetry monitor turns off the audio, the screen display the “Local Audio Off” message, and the screen brightness turns dimmer.
-

14.5 Removing the Battery

CAUTION

- Some failure conditions, such as short circuits, can cause a battery to overheat during using. High temperature can cause burns to the patient or user. If the device becomes too hot to the touch, remove it from the patient and place aside until it cools. Then remove the battery from the device, and contact your service personnel to identify the cause of overheating.
 - Avoid scraping the metal contactor in the battery compartment while removing the lithium-ion battery pack or AA battery frame. Otherwise, the broken contact will affect the power supply performance.
 - Remove the battery before transporting the device or if the device is not in use or is being stored.
-

NOTE

- Retain the ECG cable and SpO₂ module with the device while removing the battery.
-

1. Lift up the lithium-ion battery pack or AA battery tray at the bottom of the compartment to pop it out.

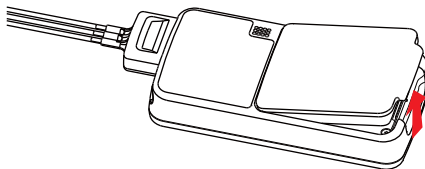

2. Remove the lithium-ion battery pack or AA battery tray from the telemetry monitor.

14.6 Charging the Rechargeable Lithium-ion Battery

WARNING

- Only use the specified central charger to charge the lithium-ion batteries designated by Mindray.
 - Only use the approved power cord with the grounded mains plug to firmly connect the central charger to a grounded AC mains socket. Never refit the mains plug to fit an ungrounded AC mains socket.
 - Do not use the Multiple Portable Socket Outlets (MPSO) or AC mains extension cords. Use an IEC 60601-1 approved isolation / separation transformer, otherwise, it may result in leakage current. Insure that the sum of the individual ground leakage currents does not exceed the allowable limits.
 - Do not place any shield object (such as cloth or paper) to cover the central charger or batteries, and keep ventilated while charging the lithium-ion batteries.
 - Do not connect other devices to the power supply system.
 - Do not use the central charger to charge the lithium-ion batteries in high temperature above 40°C.
-
-

Use the central charger to charge the lithium-ion batteries. The central charger can charge 10 lithium-ion batteries at one time. For details about the central charger, refer to *BeneVision Central Charger Operator's Manual*.

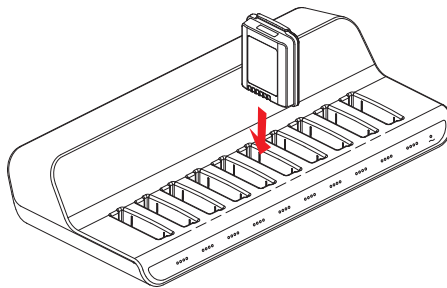

14.7 Storing the Batteries

14.7.1 Storing Rechargeable Lithium-ion Batteries

When storing batteries, make sure that the battery terminals do not come into contact with metallic objects.

If you need to store the batteries for an extended period of time, place the batteries in a cool, dry place (ideally at 15°C or 60°F) with a partial charge of about 50% capacity (two LEDs illuminated). Storing batteries in a cool place can slow the aging process.

Stored batteries should be charged to about 50% of their capacity every six months. The battery should be fully charged prior to first use.

NOTE

- **Remove the lithium-ion battery from the device if the device is not used for a prolonged time (for example, several weeks), and keep the device in clean place to avoid the dust or liquid entering the battery compartment.**
 - **Storing batteries at high temperatures for an extended period of time will significantly shorten their life expectancy.**
 - **Do not store the batteries in an environment above 60°C (122°F) or lower than -20°C (4°F).**
-

14.7.2 Storing AA Batteries

If you remove undepleted AA batteries from the telemetry monitor and need to store the batteries, keep the batteries together as a set for later re-use so that all batteries will have the same level of remaining power.

Do not store disposable AA batteries by leaving the batteries in the incorrect polarity position in the telemetry monitor.

NOTE

- **Replace the AA battery tray on the battery compartment after removing the AA batteries.**
-

14.8 Maintaining the Rechargeable Lithium-ion Battery

Take care of the rechargeable lithium-ion battery once you receive a new battery for use. The following table describes the battery maintenance activities and recommended frequency.

Activity	Recommended Frequency
Visual inspection	Before installing a battery in the telemetry monitor.
Charge the battery	Upon receipt, after use, a "Low Battery" or "Critically Low Battery" alarm occurs. To optimize performance, a fully or almost fully discharged battery must be charged immediately.
Clean the battery	At each patient discharge, or in case that the battery is exposed to contaminants. Do not clean the battery connector during the cleaning.
Charge stored battery to at least 40% of the battery capacity.	Every six months if the telemetry monitor is not in use for an extended period of time.
Dispose of the battery	When the "Battery Maintenance Required" alarm message displays on the telemetry monitor.

The lifetime of a lithium-ion battery depends on the frequency and duration of use. With good maintenance, the useful life is approximately 500 complete charge-discharge cycles. Experience indicates that the incidence of failure may increase with battery service life due to the accumulated stresses of daily use. Therefore, Mindray strongly recommend that lithium-ion battery should be replaced after two years or 500 complete charge-discharge cycles. Using the outdated battery may cause the device abnormality and unacceptable performance.

The age of a lithium-ion battery begins at the date of manufacture. The date of manufacture is listed on the rear of the battery.

NOTE

- **The battery capacity degrades as using time and number of recharge cycles. Toward the end of its useful life, the battery capacity may be reduced by 20% to 25%. If the reduced battery life is unacceptable for your device, Mindray recommends the battery be replaced.**

14.9 Disposing of the Batteries

14.9.1 Disposing of the Rechargeable Lithium-ion Battery

Discard the lithium-ion battery in the following situations:

- The battery has visual signs of damage.
- The battery fails.
- The battery is aged and its runtime significantly less than the specification.

- The battery has been used for more than two years or 500 complete charge-discharge circles.

Discharge the battery and insulate the terminals with tape before disposal. Properly dispose of the batteries according to local regulations.

14.9.2 Disposing of the AA Batteries

The batteries may be subject to local regulations regarding disposal. Dispose of batteries in approved containers. Follow local regulations, if any, to recycle the batteries.

This page intentionally left blank.

15 Troubleshooting

15.1 General Problems

The following table lists the problems that are likely to occur. If the problem persists after corrective actions have been taken, contact your service personnel.

For methods to troubleshoot the central charger, refer to ***BeneVision Central Charger Operator's Manual***. For methods to troubleshoot the BP10, refer to ***BP10 NIBP Module Operator's Manual***.

Symptom	Possible cause	Solution
ECG noise	The noise interference is overlapped with ECG waveforms.	<ol style="list-style-type: none">1. Check that the electrodes are in good contact with the skin.2. Check that the ECG leadwires are connected securely.3. Check that the patient does not contact any ungrounded electric equipment.
ECG signal saturated	The telemetry monitor detected ECG signal saturation or overload.	<ol style="list-style-type: none">1. Check the ECG leadwires.2. Check that the electrodes are in good contact with the skin.3. Check that the electrodes are not expired.
The telemetry monitor or SpO ₂ module is started repeatedly.	The battery capacity for the telemetry monitor is depleted.	Replace with a known good battery.
The SpO ₂ data is not displayed on the Central Station.	<ol style="list-style-type: none">1. The SpO₂ module is not connected to the telemetry monitor.2. There might be a problem with the SpO₂ module.	<ol style="list-style-type: none">1. Connect the SpO₂ module to the telemetry monitor.2. Replace the SpO₂ module with a known good one.

Symptom	Possible cause	Solution
<p>The telemetry monitor cannot be connected to the Central Station wirelessly and the wireless symbol on the main screen of the telemetry monitor is displayed as  .</p>	The wireless access point (AP70) in the vicinity is not enabled.	Make sure that the wireless access point is enabled and belongs to the Virtual LAN (VLAN) where the telemetry monitor is covered.
	The telemetry monitor is not powered on under the AP70 coverage area.	Put the telemetry monitor within the wireless access point coverage area and restart it. Ensure that the signal strength displayed on the telemetry monitor is greater than -65dBm.
	Items like SSID, WMTS band are not configured correctly for the telemetry monitor.	Contact your service personnel.
	Items like SSID, WMTS band are not configured properly for the wireless access point.	
	The telemetry monitor has a fault.	
<p>The telemetry monitor has been connected to the wireless network but cannot be connected to the Central Station.</p>	The telemetry monitor is not admitted by the Central Station yet.	
	Failed to acquire the IP address.	
	Static IP conflict	
<p>Single telemetry monitor is offline occasionally.</p>	The telemetry monitor is located in the blind area of wireless coverage.	
	The telemetry monitor has a fault.	
	Static IP conflict	
<p>Some telemetry monitors are offline occasionally.</p>	The wireless access point in some area is damaged.	
	Severe interference occurs in some areas.	
	The signal strength is weak some areas.	
<p>All the telemetry monitors are offline occasionally.</p>	Partial wired network is not configured properly.	
	Wireless interference	

Symptom	Possible cause	Solution
The telemetry monitor cannot establish connection with the BP10.	Configuration error	Verify that MPAN at the telemetry monitor is set to Connect to BP10 and the MPAN key on the BP10 is pressed.
The telemetry monitor and BP10 are prone to offline.	When the telemetry monitor and BP10 are secured to the patient, signals may be blocked by the patient's body.	Put the telemetry monitor and BP10 closer.
The telemetry monitor and BP10 are prone to offline in certain area.	As there are many wireless devices in this area, communication between the telemetry monitor and BP10 is interfered seriously.	Contact your service personnel.
Some telemetry monitor or BP10 is prone to offline.	Device malfunction	

15.2 Physiological Alarm Messages at the Telemetry Monitor

The following table lists the major physiological alarm messages displayed in the prompt message area of the telemetry monitor.

Measurement	Alarm message	Default Alarm priority	Possible cause	Solution
ECG	HR High	Med*	HR value has risen above the high alarm limit or fallen below the low alarm limit.	Check the patient's condition and make sure that the patient category and alarm limit settings are correct.
	HR Low			

* The asterisk (*) means the alarm priority is configurable.

** XX is the ECG lead name.

Measurement	Alarm message	Default Alarm priority	Possible cause	Solution
ECG	Asystole	High	The patient is in arrhythmia.	Check the patient's condition and the ECG connections.
	V-Fib/V-Tach			
	V-Tach			
	Vent Brady			
	Extreme Tachy			
	Extreme Brady			
	R on T	Med*		
	Run PVCs	Low*		
	Couplet	Prompt*		
	Multiform PVC	Med*		
	PVC	Prompt*		
	Bigeminy	Med*		
	Trigeminy			
	Tachy			
	Brady			
	Missed Beats	Prompt*		
	Nonsus V-Tach	Med*		
	Vent Rhythm			
	Pause	Low*		
	Irr Rhythm	Prompt*		
A-Fib				
PVCs/min	Med*			
Pauses/min				

* The asterisk (*) means the alarm priority is configurable.

** XX is the ECG lead name.

Measurement	Alarm message	Default Alarm priority	Possible cause	Solution
ECG	Pacer Not Capture	Prompt*	The pacer appears abnormal.	Check the pacer.
	Pacer Not Pacing			
	Irr Rhythm End	Prompt	Irregular rhythm no longer detected for the irregular rhythm end delay time.	Check the patient's condition and the ECG connections.
	A-Fib End	Prompt	Atrial fibrillation no longer detected for the Afib end delay time.	
	ST Single Alarm Violation	Med*	The ST value of any ST lead has risen above the high alarm limit or fallen below the low alarm limit.	Check the patient's condition and check if the patient category and alarm limit settings are correct.
	ST Dual Alarm Violation	Med*	The ST value of two or more ST leads has risen above the high alarm limit or fallen below the low alarm limit.	Check the patient's condition and check if the patient category and alarm limit settings are correct.
	ST-XX** High	Med*	The ST value has risen above the high alarm limit or fallen below the low alarm limit.	Check the patient's condition and check if the patient category and alarm limit settings are correct.
ST-XX** Low	Med*			

* The asterisk (*) means the alarm priority is configurable.

** XX is the ECG lead name.

Measurement	Alarm message	Default Alarm priority	Possible cause	Solution
ECG	QTc High	Med*	The QT value has risen above the high alarm limit.	Check the patient's condition and check if the patient category and alarm limit settings are correct.
	Δ QTc High	Med*		
Resp	RR High	Med*	RR value has risen above the high alarm limit or fallen below the low alarm limit.	Check the patient's condition and make sure that the patient category and alarm limit settings are correct.
	RR Low			
	No Chest Movement	High	The respiration signal was so weak that the monitor cannot perform respiration analysis.	Check the patient's condition, module and patient connections.
	Resp Artifact		The patient's heartbeat has interfered with his respiration.	

* The asterisk (*) means the alarm priority is configurable.

** XX is the ECG lead name.

Measurement	Alarm message	Default Alarm priority	Possible cause	Solution
SpO ₂	SpO ₂ High	Med*	SpO ₂ value has risen above the high alarm limit or fallen below the low alarm limit.	Check the patient's condition and make sure that the patient category and alarm limit settings are correct.
	SpO ₂ Low			
	SpO ₂ Desat	High	The SpO ₂ value has fallen below the desaturation alarm limit.	
	PR High	Med*	PR value has risen above the high alarm limit or fallen below the low alarm limit.	
	PR Low			
	No Pulse	High	The pulse signal was so weak that the monitor cannot perform pulse analysis.	
NIBP	NIBP-S High	Med*	The NIBP systolic pressure has risen above the high alarm limit or fallen below the low alarm limit.	Check the patient's condition and check if the alarm limit settings and patient category are correct.
	NIBP-S Low			
	NIBP-M High		The NIBP mean pressure has risen above the high alarm limit or fallen below the low alarm limit.	
	NIBP-M Low			
	NIBP-D High		The NIBP diastolic pressure has risen above the high alarm limit or fallen below the low alarm limit.	
	NIBP-D Low			

* The asterisk (*) means the alarm priority is configurable.

** XX is the ECG lead name.

Measurement	Alarm message	Default Alarm priority	Possible cause	Solution
NIBP	NIBP-S Extremely High	High	The NIBP systolic pressure has risen above the extreme alarm high limit or fallen below the extreme alarm low limit.	Check the patient's condition and check if the alarm limit settings are correct.
	NIBP-S Extremely Low			
	NIBP-M Extremely High		The NIBP mean pressure has risen above the extreme alarm high limit or fallen below the extreme alarm low limit.	
	NIBP-M Extremely Low			
	NIBP-D Extremely High		The NIBP diastolic pressure has risen above the extreme alarm high limit or fallen below the extreme alarm low limit.	
	NIBP-D Extremely Low			

* The asterisk (*) means the alarm priority is configurable.

** XX is the ECG lead name.

15.3 Technical Alarm Messages at the Telemetry Monitor

The following table lists the major technical alarm messages displayed in the prompt message area of the telemetry monitor.

The Alarm Indication column in the table below is capable of three different indication types: A, B, C.

- A: The alarm sound will be silenced, the alarm light will continue to indicate the alarm, a ✓ will appear before the alarm message. The  symbol appears on the top of the main screen.
- B: The technical alarm will be changed to the prompt message, it will not longer make sound or be indicated by the alarm light.
- C: The technical alarms are cleared, there will be no alarm indications.

Measurement	Alarm message	Default Alarm priority	Alarm Indication	Possible cause	Solution
ECG	ECG Lead Off	Low*	B	The electrode has become detached from the patient or the lead wire has become disconnected from the adapter cable.	Check the connections of the electrodes and leadwires.
	ECG XX** Lead Off	Low*	B		
	ECG Module Error	High	A	An error occurred to the ECG module. There is a problem with the communications between the module and the telemetry monitor.	Restart the telemetry monitor. If the problem persists, contact your service personnel.

* The asterisk (*) means the alarm priority is configurable.

** XX is the ECG lead name.

Measurement	Alarm message	Default Alarm priority	Alarm Indication	Possible cause	Solution
ECG	ECG Noisy	Low	A	The ECG signal is noisy.	Check for any possible sources of signal noise around the cable and electrode, and check the patient for great motion.
	HR Overrange	Low	A	HR exceeds the measurement limit.	Contact Mindray or your service personnel.
	ECG Learning	Prompt	/	ECG learning is manually or automatically triggered.	/
	Cannot perform ST analysis	Prompt	A	/	/
	Cannot Analyze QT	Prompt	A	/	/
	Check Leads	Prompt	/	ECG original sampling exceeds signal saturation threshold.	/
Resp	Electrode Poor Contact	Prompt	/	The electrode has been used for a long time or the electrode contact is poor.	Check the electrode application. Reposition or replace the electrodes if necessary.

* The asterisk (*) means the alarm priority is configurable.

** XX is the ECG lead name.

Measurement	Alarm message	Default Alarm priority	Alarm Indication	Possible cause	Solution	
SpO ₂	SpO ₂ Sensor Off	Low*	B	The SpO ₂ sensor has become detached from the patient or the module.	Check the sensor application site and the sensor type, and make sure the sensor is not damaged. Reconnect the sensor or use a new sensor.	
	SpO ₂ Sensor Fault	Low	C			
	SpO ₂ No Sensor	Low	B	There is a fault with the SpO ₂ sensor.		
	SpO ₂ Module Error	High	A	An unspecified SpO ₂ sensor has been used.		
	SpO ₂ Excess Light	Low	A	There is too much light on the SpO ₂ sensor.		Move the sensor to a place with lower level of ambient light or cover the sensor to minimize the ambient light.
	SpO ₂ No Pulse	Low	A	SpO ₂ sensor failed to obtain pulse signal.		Move the sensor to a site with better perfusion.
SpO ₂	SpO ₂ Unplugged	Low	C	SpO ₂ module connector is disconnected from the telemetry monitor.	Reconnect the SpO ₂ module to the telemetry monitor.	
	SpO ₂ Sensor Incompatible	Low	C	Incompatible or an unspecified SpO ₂ sensor is used.	Use specified SpO ₂ sensors.	

* The asterisk (*) means the alarm priority is configurable.

** XX is the ECG lead name.

Measurement	Alarm message	Default Alarm priority	Alarm Indication	Possible cause	Solution
SpO ₂	SpO ₂ Signal Weak	Low	C	The SpO ₂ signal is too low.	Check the patient's condition and change the sensor application site. If the error persists, replace the sensor.
	SpO ₂ Interference	Low	C	The SpO ₂ signal has interference.	Check for any possible sources of signal noise and check the patient for excessive motion.
	SpO ₂ Low Perfusion	Prompt	/	The SpO ₂ sensor is not properly placed or the patient's perfusion index is too low.	1. Check the sensor and sensor position. 2. Reposition the sensor if necessary.
	PR Overrange	Low	A	The measured PR value exceeds the measurement range.	Contact Mindray or your service personnel.

* The asterisk (*) means the alarm priority is configurable.

** XX is the ECG lead name.

Measurement	Alarm message	Default Alarm priority	Alarm Indication	Possible cause	Solution
NIBP	NIBP Low Battery	Med	A	The battery charge is low.	Replace with a new battery.
	NIBP Battery Depleted	High	A	The battery charge is almost depleted.	
	NIBP Voltage Error	High	A	The lithium-ion battery voltage is out of the specified range.	
	NIBP Battery Error	High	A	The lithium-ion battery communication is error.	
	NIBP Battery Maintenance Required	Med	A	The lithium-ion battery is aging.	
	MPAN Disconnected	Med	C	The MAPN is disconnected.	
	NIBP Clock Needs To Be Set	Low	C	The button cell does not have sufficient charge.	Reset the system time for the BP10.
NIBP	NIBP Module Error	High	A	<ul style="list-style-type: none"> An error occurred to the NIBP module. There is a problem with communication between the telemetry monitor and BP10. 	Restart the BP10.

* The asterisk (*) means the alarm priority is configurable.

** XX is the ECG lead name.

Measurement	Alarm message	Default Alarm priority	Alarm Indication	Possible cause	Solution
NIBP	NIBP Cuff Loose	Low	C	<ul style="list-style-type: none"> The NIBP cuff is not properly connected. There is a leak in the airway. 	<ol style="list-style-type: none"> Check the patient's condition and verify patient category. Replace with an appropriate cuff and connect it correctly.
	NIBP Airway Error	Low	C	An airway error occurred.	Check the airway.
	NIBP Weak Signal	Low	C	The patient's pulse is weak or the cuff is loose.	Check the patient's condition and change the cuff application site. If the error persists, replace the cuff.
	NIBP Overrange	Low	C	The measured NIBP value is not within the specified range.	Contact your service personnel.
	NIBP Excessive Motion	Low	C	Patient's arm moves too much.	Check the patient's condition and reduce the patient motion.
	NIBP Cuff Overpressure	Low	C	The NIBP airway may be occluded.	Check the airway and measure again.

* The asterisk (*) means the alarm priority is configurable.

** XX is the ECG lead name.

Measurement	Alarm message	Default Alarm priority	Alarm Indication	Possible cause	Solution
NIBP	NIBP Cuff or Airway Leak	Low	C	The NIBP airway may leak air.	<ol style="list-style-type: none"> 1. Verify that the cuff is properly connected. 2. 2. Verify that the airway does not leak air.
	NIBP Timeout	Low	C	<ul style="list-style-type: none"> • Time is out. • The measurement time is over 120 seconds. 	<ol style="list-style-type: none"> 1. Check the patient's condition and NIBP connections. 2. Replace the cuff.
	NIBP Cuff and Patient Mismatch	Low	C	The cuff type applied mismatches the patient category.	<ol style="list-style-type: none"> 1. Check the patient's category. 2. Replace the cuff.
	Intervals Not Set	Low	C	The interval in Sequence mode is not set.	Set the intervals.
	NIBP-S Overrange	Low	A	The measured NIBP value is not within the measurement range.	Contact your service personnel.
	NIBP-D Overrange	Low	A		
	NIBP-M Overrange	Low	A		

* The asterisk (*) means the alarm priority is configurable.

** XX is the ECG lead name.

Measurement	Alarm message	Default Alarm priority	Alarm Indication	Possible cause	Solution
Power	Low Battery	Med	A	The battery charge is low.	Replace with new batteries.
	Critically Low Battery	High	A	The battery charge is almost depleted.	
	Battery Maintenance Required	Med	A	The lithium-ion battery is aging.	
	Battery Error	Med	A	The lithium-ion battery communication error occurred.	
	Battery Type Error	Med	A	The battery contacts are in bad contact.	

* The asterisk (*) means the alarm priority is configurable.

** XX is the ECG lead name.

Measurement	Alarm message	Default Alarm priority	Alarm Indication	Possible cause	Solution
System	Device Error	High	A	<p>An error occurred while performing the self-test of the main board.</p> <p>An error occurred while performing the self-test of the parameter module or bluetooth module.</p> <p>The parameter module communication error or initialization error occurred.</p>	Restart the telemetry monitor. If the problem persists, contact your service personnel.
	Real Time Clock Error	High	A	An error occurred while initializing the real time clock.	
	Restoring Last Defaults Failed	Low	C	An error occurred while restoring the last default configuration.	
	Loading Defaults Failed	Low	C	An error occurred while loading the default configuration.	

* The asterisk (*) means the alarm priority is configurable.

** XX is the ECG lead name.

This page intentionally left blank.

16 Cleaning and Disinfecting

16.1 Introduction

In this chapter we describe how to clean and disinfect the telemetry monitor and its accessories.

16.2 Safety Information

CAUTION

- **Use only Mindray approved cleaners and disinfectants and methods listed in this chapter to clean or disinfect your equipment. Warranty does not cover damage caused by unapproved substances or methods.**
 - **Mindray makes no claims regarding the efficacy of the listed chemicals or methods as a means for controlling infection. For the method to control infection, consult your hospital's infection control officer or epidemiologist.**
 - **Non-medical equipment does not provide the same level of protection against electrical shock. Do not touch the patient and any part of nonmedical equipment at the same time. Some examples of non-medical equipment are laser printers and nonmedical computers.**
 - **The responsible hospital shall carry out all cleaning and disinfection procedures specified in this chapter.**
 - **Avoid use of cleaners, materials or chemicals that may damage equipment surfaces, labels, or cause equipment failures.**
 - **Never immerse any part of the equipment or accessories in liquids or allow liquid to enter the interior.**
 - **Do not pour or spray any liquid directly on the equipment or accessories or permit fluid to seep into connections or openings.**
 - **Remove the equipment from use if liquid is spilled on the equipment or accessories. Contact your service personnel.**
 - **Check the equipment after cleaning and disinfecting. If there is any sign of damage, remove it from use.**
 - **Be sure to disconnect all power cables from the outlets before cleaning the equipment.**
-

16.3 Cleaning and Disinfecting the Equipment

16.3.1 Approved Cleaning and Disinfecting Agents

The following table lists approved cleaning and disinfecting agents:

Product Name	Product Type	Active Ingredients
Sodium hypochlorite bleach*	Liquid	Sodium hypochlorite bleach 10%
Hydrogen peroxide*		Hydrogen peroxide 3%
Isopropanol*		Isopropanol 70%
1-Propanol*		1-Propanol 50%
Metrex CaviCide1™		Diisobutylphenoxyethoxyethyl dimethyl benzyl ammonium chloride 0.28%, Isopropanol 17.2%
Virex® II 256		Didecyl dimethyl ammonium chloride 8.704%, n-Alkydimethyl benzyl ammonium chloride 8.190%
Virex® TB		n-Alkyl dimethyl benzyl ammonium chlorides 0.105%, n-Alkyl dimethyl ethylbenzyl ammonium chlorides 0.105%
Rely+On™ Virkon® Powder * (Used as 1% solution)	Powder	Used as 1% solution Biocidal active: Pentapotassium bis (peroxymonosulphate) bis (sulphate)(500g/kg), Contains dipotassium peroxodisulphate.

Product Name	Product Type	Active Ingredients
Alpet® D2 Surface Sanitizing Wipes	Wipes	Isopropyl Alcohol 58.6000%? Octyl Decyl Dimethyl Ammonium chloride 0.0075%, Dioctyl Dimethyl Ammonium Chloride 0.0030%
Clorox Dispatch® Hospital Cleaner Disinfectant Towels with Bleach		Sodium Hypochlorite 0.65%
Clorox Healthcare® Bleach Germicidal Wipes		Sodium Hypochlorite 0.55%
Clorox Healthcare® Hydrogen Peroxide Cleaner Disinfectant Wipes		Hydrogen Peroxide 1.4%
Diversey Oxivir® TB Wipes		Hydrogen Peroxide 0.5%
Metrex CaviWipes™		Diisobutylphenoxyethoxyethyl dimethyl benzyl ammonium chloride 0.28%, Isopropanol 17.2%
PDI Sani-Cloth® AF3 Germicidal Disposable Wipe		n-Alkyl dimethyl ethylbenzyl ammonium chlorides 0.14%, n-Alkyl dimethyl benzyl ammonium chlorides 0.14%
PDI Sani-Cloth® Bleach Germicidal Disposable Wipe		Sodium Hypochlorite 0.63%,other ingredients 99.37%
PDI Sani-Cloth® HB Germicidal Disposable Wipe		n-Alkyl dimethyl ethylbenzyl ammonium chlorides 0.07%, n-Alkyl dimethyl benzyl ammonium chlorides 0.07%
PDI Sani-Cloth® Plus Germicidal Disposable Cloth		n-Alkyl dimethyl ethylbenzyl ammonium chlorides 0.125%, n-Alky dimethyl benzyl ammonium chlorides 0.125%
PDI Super Sani-Cloth® Germicidal Disposable Wipe *		n-Alkyl dimethyl ethylbenzyl ammonium chlorides 0.25%, n-Alkyl dimethyl benzyl ammonium chlorides 0.25%, Isopropyl Alcohol 55.0%,
VIRAGUARD Hospital Surface Disinfectants		Isopropanol 70%,Other ingredients 30%

NOTE

- For equipment with the symbol , all the listed cleaning and disinfecting agents are available for use. For equipment without the symbol , only the cleaning and disinfecting agents marked with "*" are available for use.
-

16.3.2 Cleaning the Equipment

Clean your equipment on a regular basis. Before cleaning the equipment, consult your hospital's regulations for cleaning the equipment.

Before cleaning the equipment, make the following preparation:

- Install the battery pack or battery tray and firmly close to seal the battery compartment.
- Insert the SpO₂ cover in the SpO₂ connector when SpO₂ is not in use.
- Insert the ECG leadwire plug into the ECG connector.



To clean the equipment, follow this procedure:

1. Shut down the device.
2. Clean the display screen with wipes or a soft cloth moistened with one of the cleaning agents listed in **16.3.1 Approved Cleaning and Disinfecting Agents** only.

3. Clean the exterior surface of the main unit and lithium-ion battery pack with wipes or a soft cloth moistened with one of the cleaning agents listed in **16.3.1 Approved Cleaning and Disinfecting Agents** only.
4. Wipe off all the cleaning agent residue with a dry cloth.
5. Dry the equipment in a ventilated, cool place.

CAUTION

- **Always dilute according to the manufacturer's instructions or use lowest possible concentration.**
 - **Take extra care when cleaning the display screen because it is more sensitive to rough cleaning method.**
 - **Never allow the cleaning solutions to spill or enter the plug, connector or battery compartment. If liquid has accidentally entered the equipment or its parts, shut down the equipment and have the device serviced by authorized service personnel.**
 - **Never immerse the lithium-ion battery pack, AA battery tray and AA batteries in any fluids.**
 - **As the battery compartment is not water proof, do not contact the battery contacts when cleaning the equipment.**
 - **Do not hook the battery contacts in the battery compartment with other objects. Otherwise, the battery contacts may be distorted.**
 - **Keep the battery compartment free away from any foreign objects.**
-

16.3.3 Disinfecting the Equipment

Disinfect the equipment as required in your hospital's servicing schedule using the disinfecting agents list in **16.3.1 Approved Cleaning and Disinfecting Agents**. Cleaning before disinfection is recommended.

CAUTION

- **To maximize effectiveness and minimize buildup of residual disinfectants, please strictly adhere to disinfectant manufacturer's instructions for use.**
 - **Wring excess disinfectant from wipe before using.**
 - **Never allow the disinfectants to spill or enter the plug, connector or battery compartment. If liquid has accidentally entered the equipment or its parts, shut down the equipment and have the device serviced by authorized service personnel.**
-

16.4 Cleaning and Disinfecting ECG Leadwires and SpO₂ Sensors

To clean and disinfect reusable ECG leadwires and SpO₂ sensors, refer to the instructions for use delivered with the accessory.

16.5 Cleaning and Disinfecting Other Parts

Other parts refer to the interior surface of lithium-ion battery pack or battery tray, the battery compartment, ECG connector, SpO₂ connector, and SpO₂ cable, as shown below.



Clean or disinfect other parts only when needed or as required in your hospital's servicing schedule.

To clean and disinfect other parts, follow this procedure:

1. Shut down the device.
2. Remove the lithium-ion battery pack or battery tray from the telemetry monitor.
3. Unplug the ECG leadwire and SpO₂ cable from the telemetry monitor.
4. Clean and disinfect other parts with a soft cloth moistened with alcohol. During cleaning and disinfection, always avoid metallic objects.
5. Wipe off the alcohol residue with a dry cloth.
6. Dry these parts in a ventilated, cool place.

CAUTION

- **Do not clean or disinfect the metal objects.. Otherwise, metal part corrosion or product reliability deterioration could result.**
-

16.6 Sterilization

Sterilization is not recommended for this equipment, related products, accessories or supplies unless otherwise indicated in the instructions for use delivered with the products, accessories or supplies.

16.7 Impact of Improper Cleaning or Disinfection

Using cleaning agents or disinfectants other than those recommended may have the following impact:

- Product discoloration
- Metal part corrosion
- Brittle and breaking wires, connectors, and equipment housing
- Reduced cable and leadwire life
- Overall system performance degradation
- Equipment malfunction or failure

This page intentionally left blank.

17 Maintenance

17.1 Introduction

The chapter outlines the routine telemetry devices maintenance guidelines.

The telemetry devices are designed for stable operation over long periods of time. Under normal circumstances the devices should not require technical maintenance beyond that described in this chapter. However, routine maintenance, calibration and safety checks are recommended at least once a year or more often as required by local statutory or hospital administration practice.

17.2 Safety

WARNING

- **Failure on the part of the responsible individual hospital employing the use of this equipment to implement a satisfactory maintenance schedule may cause undue equipment failure and possible health hazards.**
 - **The safety checks or maintenance involving any disassembly of the equipment should be performed by service personnel. Otherwise, undue equipment failure and possible health hazards could result.**
 - **No modification of this equipment is allowed.**
 - **Do not open the equipment housings. All servicing and future upgrades must be carried out by the service personnel.**
 - **All replaced components and accessories as well as consumables are provided or qualified by Mindray.**
 - **If you discover a problem with any of the equipment, contact your service personnel or Mindray.**
 - **The service personnel must be properly qualified and thoroughly familiar with the equipment operation.**
-
-

17.3 Regular Check

Perform a visual inspection before the equipment is first used every day. Verify that the equipment meets the following requirements:

- The housing and display screen are free from cracks or other damages.
- All keys function properly.
- Connectors are not loose, cracked, or bent and cables have no cuts, nicks, or fraying.
- ECG leadwires are securely connected with the equipment
- Battery pack is installed and has sufficient charge.

After your equipment has been used for 6 to 12 months, or whenever your equipment is repaired or upgraded, a thorough inspection should be performed by qualified service personnel to ensure the reliability.

Follow these guidelines when inspecting the devices:

- Make sure that the environment and power supply meet the requirements.
- Inspect the devices and their accessories for mechanical damage.
- Inspect all plugs, connectors, leadwires for damage, and make sure that their insulation is in good condition.
- Make sure that only specified accessories are applied.
- Make sure that the alarm system functions correctly.
- Make sure that the battery meet the performance requirements.
- Make sure that the devices are in good working condition.

In case of any damage or abnormality, do not use the devices. Contact the hospital's biomedical engineers or your service personnel immediately.

17.4 Maintenance and Testing Schedule

The following maintenance and tests, except for visual inspection, power on test, and battery check, shall be carried out by the service personnel only. Contact your service personnel if any maintenance is required. Make sure to clean and disinfect the equipment before any test and maintenance.

Check/Maintenance Item		Recommended Frequency
Visual inspection		When first installed or reinstalled.
Power-on test		<ol style="list-style-type: none"> When first installed or reinstalled. Following any repairs or replacement of relevant component.
ECG verification	Performance test	<ol style="list-style-type: none"> If the user suspects that the measurement is incorrect. Following any repairs or replacement of relevant module. Once every two years. Note: NIBP test should be performed at least once a year.
	Verification	
Resp test	Performance test	
SpO ₂ test		
NIBP test	Pressure check	
	Leakage test	
Nurse call test		If the user suspects that the nurse call functionality does not work properly.
Electrical safety tests		<ol style="list-style-type: none"> After the telemetry monitor or central charger falls off. At least once every two years or as needed
Network print test		<ol style="list-style-type: none"> When first installed. Whenever the printer is serviced or replaced.
Battery check	Functionality test	<ol style="list-style-type: none"> When first installed. Whenever the battery is replaced.
	Performance test	For rechargeable lithium-ion battery: once every two months or when the battery run time is reduced significantly.

17.5 Power-on Test

The telemetry monitor performs a self-test during startup. You can refer to **3.5 Powering On the Unit** for details.

17.6 Verifying the ECG

The ECG signal may be inaccurate due to hardware or software problems. As a result, the ECG wave amplitude becomes greater or smaller. To verify the ECG waveform amplitude:

1. In the main menu, tap **Parameter Setup**.
2. Tap **ECG** and set **Filter** to **Monitor**.
3. In the main menu, tap **Maintenance**.
4. Input the maintenance passcode and tap **Accept**.
5. In the **Maintenance** menu, tap **General**.
6. Enable **Calibrate ECG**.
7. Compare the amplitude of the square wave with the wave scale. The difference should be within 5%. If the difference exceeds 5%, contact your service personnel.
8. After completing the verification, disable **Calibrate ECG**.

A square wave appears on the screen and the message **ECG Calibrating** is displayed.

17.7 NIBP Accuracy Test

The NIBP accuracy test is required at least once a year or when you doubt the measured NIBP result. Contact your service personnel to perform NIBP accuracy test.

17.8 NIBP Leakage Test

The NIBP leakage test checks the integrity of the system and of the valve. It is required at least once a year or when you doubt the measured NIBP result. Contact your service personnel to perform NIBP leakage test.

17.9 Nurse Call Test

The nurse call test checks whether this functionality can work properly. Contact your service personnel to perform the nurse call test.

17.10 Electrical Safety Tests

The electrical safety tests aim to detect abnormalities that, if undetected, could prove dangerous to either the patient or the operator. Contact your service personnel to perform the electrical safety tests.

17.11 Battery Check

For details about the battery charge check and maintenance, refer to **14.8 Maintaining the Rechargeable Lithium-ion Battery**.

17.12 Viewing System Information

To view the system information of the telemetry monitor, such as battery, tap **System Info** from the main menu.

This page intentionally left blank.

18 Accessories

The accessories listed in this chapter comply with the requirements of IEC 60601-1-2 when in use with the device. The accessory material that contacts the patients has undertaken the bio-compatibility test and is verified to be in compliance with ISO 10993-1. For details about the accessories, refer to the instructions for use provided with the accessory.

WARNING

- **Use accessories specified in this chapter. Using other accessories may cause damage to the monitor or not meet the claimed specifications.**
 - **Single-use accessories are not designed to be reused. Reuse may cause a risk of contamination and affect the measurement accuracy.**
 - **Check the accessories and their packages for any sign of damage. Do not use them if any damage is detected.**
 - **Use the accessories before the expiry date if indicated.**
 - **The disposable accessories shall be disposed of according to the hospital's regulations.**
-
-

18.1 ECG Accessories

18.1.1 ECG Electrodes

PN	Description	Applicable property	Applicable patient
0010-10-12304	Adult Electrode (Kendall, package of 10)	Disposable	Adult
9000-10-07469	Pediatric ECG electrode (3M, package of 50)	Disposable	Pediatric

18.1.2 ECG Leadsets

3-Lead

PN	Description	Applicable property	Applicable patient
009-004765-00	3-Lead, New Telemetry, AHA, Snap, 24"	Reusable	Adult, Pediatric
009-004766-00	3-Lead, New Telemetry, AHA, Snap, 36"		
009-004771-00	3-Lead, New Telemetry, AHA, Pinch, 24"		
009-004772-00	3-Lead, New Telemetry, AHA, Pinch, 36"		
115-032954-00	3-Lead, New Telemetry, Disp, AHA, Snap, 24" (20/box)	Disposable	

5-Lead

PN	Description	Applicable property	Applicable patient
009-004782-00	5-Lead, New Telemetry, AHA, Snap, 24"	Reusable	Adult, Pediatric
009-004783-00	5-Lead, New Telemetry, AHA, Snap, 36"		
009-004786-00	5-Lead, New Telemetry, AHA, Pinch, 24"		
009-004787-00	5-Lead, New Telemetry, AHA, Pinch, 36"		
115-032955-00	5-Lead, New Telemetry, AHA, Snap, 24" (20/box)	Disposable	

6-Lead

PN	Description	Applicable property	Applicable patient
009-004794-00	6-Lead, New Telemetry, AHA, Snap, 24"	Reusable	Adult, Pediatric
009-004795-00	6-Lead, New Telemetry, AHA, Snap, 36"		
009-004798-00	6-Lead, New Telemetry, AHA, Pinch, 24"		
009-004799-00	6-Lead, New Telemetry, AHA, Pinch, 36"		

18.2 SpO₂ Accessories

The SpO₂ sensor material that contacts patients or other staff has undertaken the bio-compatibility test and is verified to be in compliance with ISO 10993-1.

18.2.1 Masimo SpO₂ Module

PN	Description	Applicable property	Applicable patient
009-004936-00	Masimo SpO2 module (SET uSpO2)	Reusable	Adult, Pediatric

18.2.2 Masimo Adapter Cable

PN	Description	Applicable property	Applicable patient
040-003381-00	RD to LNCS adapter cable, Masimo	Reusable	/

18.2.3 Masimo SpO₂ Sensor

PN	Description	Applicable property	Applicable patient
0600-00-0121	LNCS Adtx-Adult Single Patient Adhesive Sensors, >30 kg (20/box)	Disposable	Adult
0600-00-0122	LNCS Pdtx-Pediatric Single Patient Adhesive Sensors, 10-50 kg (20/box)		Pediatric
0600-00-0126	LNCS DCI Adult Reusable Finger Sensor, >30 kg	Reusable	Adult
0600-00-0127	LNCS DCIP Pediatric Reusable Finger Sensor, 10-50 kg		Pediatric
040-003376-00	SpO2 sensor, RD SET DCI		Adult (> 30 kg)
040-003377-00	SpO2 sensor, RD SET DCI		Pediatric (10-50 kg)
040-003382-00	SpO2 sensor, RD SET Adt, adhesive, pkg of 20	Disposable	Adult (> 30 kg)
040-003383-00	SpO2 sensor, RD SET PDT, adhesive, pkg of 20		Pediatric (10 to 50kg)

Wavelength emitted by the sensors is between 600 nm and 1000 nm. The maximum photic output consumption of the sensor is less than 18 mW.

The information about the wavelength range and maximum photic output consumption can be especially useful to clinicians (for example, when photodynamic therapy is performed).

18.2.4 Nellcor SpO₂ Module

PN	Description	Applicable property	Applicable patient
125-000015-00	Nellcor SpO ₂ module	Reusable	Adult, Pediatric

18.2.5 Nellcor SpO₂ Sensor

PN	Description	Applicable property	Applicable patient
9000-10-05161	Reusable SpO ₂ sensor, finger-clip	Reusable	Adult
9000-10-07308	Reusable Pediatric-Infant SpO ₂ sensor with wraps, Ped/Infant	Reusable	Pediatric
0010-10-12476	Nellcor reusable D-YS SpO ₂ sensor with wraps	Reusable	Adult, Pediatric

18.3 NIBP Accessories

For NIBP accessories, refer to *BP10 NIBP Module Operator's Manual*.

18.4 Miscellaneous

PN	Description
022-000196-00	Li-ion battery 3.8V 3800mAh
0000-10-10902	Alkaline 1.5 V AA battery (for service personnel to perform debugging only)
0146-00-0077-10	L91 AA battery
045-001699-01	TP-3AA battery tray
115-032957-00	Disposable pouch (25/box)
DA8K-10-14452	US power cord
009-005409-00	USB upgrade cable
115-026852-00	Main unit of the central charger

A Product Specifications

This chapter provides specifications of the telemetry monitor and central charger. For specifications of BP10, refer to **BP10 NIBP Module Operator's Manual**.

A.1 Classifications

The device is classified as follows according to IEC60601-1:

Type of protection against electrical shock	TM70 energized from an internal electrical power source. Central Charger: Class I AP70: Class II SYNC70: Class I AC70: Class I
Degree of protection against electrical shock for the TM70	Type CF defibrillation proof for ECG and SpO ₂ .
Mode of operation	Continuous
Degree of protection against harmful ingress of water	TM70: IPX7 Central Charger: IPX0 AP70: IPX1 SYNC70: IPX0 AC70: IPX0
Degree of protection against hazards of explosion	Not suitable: Equipment not suitable for use in the presence of a flammable anesthetic mixture with air with oxygen or nitrous oxide.
Degree of protection against hazard of dropping for the TM70	No damage by dropping from a height of 1.5 m.

A.2 Environmental Specifications

WARNING

- **The devices may not meet the performance specifications if stored or used outside the specified temperature and humidity ranges.**
-
-

Item	Operating conditions	Storage conditions
Temperature	0 °C to 40 °C	-20 °C to 60 °C
Relative humidity (noncondensing)	15% to 95%	10% to 95%
Barometric	427.5 mmHg to 805.5 mmHg, or 57.0 kPa to 107.4 kPa	120 mmHg to 805.5 mmHg, or 16.0 kPa to 107.4 kPa

A.3 Power Supply Specifications

A.3.1 TM70

The battery life listed below may be shortened by the following factors:

- Wireless signal interference
- Aging battery
- Frequent operation of turning on/off the display
- Wireless network coverage which does not meet the technical specifications in **A.7 Wireless Specification**.

Battery type	AA batteries (three) Rechargeable lithium-ion battery (one)		
Capacity for lithium-ion battery	≥ 3500 mAh		
Charge time for lithium-ion battery	At the room temperature: ≤ 5 hours to 90% charge		
Safety and authentication for lithium-ion battery	UL62133, IEC62133, UN38.3		
Battery run time (at 25 °C ±5 °C, with display off, no sound and light as default, no alarms, display lit for one minute every two hours, using L91 AA batteries (PN 0146-00-0077-10))		Three AA batteries	Lithium-ion battery
	5-lead ECG	≥36 hours	≥36 hours
	5-lead ECG+SpO ₂	≥28 hours	≥28 hours

Shutdown delay	At least 10 minutes after the low battery alarm first occurs. At least five minutes after the critically low battery alarm first occurs.
-----------------------	---

A.3.2 Central Charger

The central charger is powered by external AC power.

Input voltage	100 VAC to 240 VAC ($\pm 10\%$)
Frequency	50 Hz/60 Hz (± 3 Hz)
Input current	1.5 A to 0.75 A
Charge time	At the room temperature: ≤ 5 hours to 90% charge
Overcharge protection function	The charger automatically stops charging when the lithium-ion battery charge is full.

A.4 Physical Specifications

	Size	Weight
TM70	126 mm \times 64 mm \times 23mm	140 g \pm 30g (without batteries, SpO ₂ module, ECG leadwires, or accessories)
		230g \pm 30g (with batteries)
AP70	225 mm \times 225 mm \times 40mm (without wall-mount bracket and antennas)	850g (without wall-mount bracket)
SYNC70	470mm \times 245 mm \times 50mm	2500g
Central charger	365mm \times 171mm \times 78mm (without batteries and wall-mount bracket)	1130g (without batteries and wall-mount bracket)

A.5 Hardware Specifications

A.5.1 TM70

Display	
Screen type	Color TFT LCD screen

Screen size	3.5"
Resolution	480 pixels × 320 pixels
Display Activation (Power On/Off) key	The switch time is less than or equal to two seconds.
LED	
Alarm lamp	1 (three colors: red, yellow, and cyan)
Audio Indicator	
Speaker	1
Sound Pressure Range	45 dBA to 85 dBA
Keys	
Nurse call	1
Power On/Off	1
Main menu	1
External Connectors	
ECG connector	1
SpO₂ connector	1

A.5.2 AP70

LED	
Power lamp	1 (one color: green)
Run lamp	1 (two colors: red, green)
RF lamp	1 (two colors: blue and green)
Port	
Network port	one RJ45 port, compatible with 100BASE-TX standard, supporting POE
Button	

Reset button	1
---------------------	---

A.5.3 AC70

System requirements for computers running AC70 management software:

Hard disk	1TB minimum, supporting data redundancy by dual hard disks
Network port	2
Network adapter	1000M(minimum) self-adapting, Ethernet 802.3
CPU	6 cores and 2.1Ghz minimum
Memory	12GB minimum
Operating system	windows® 10 or windows® server 2016

A.5.4 SYNC70

LED	
Power lamp	1(one color: green)
Run lamp	1(two colors: red and green)
CLK(MAIN-BACKUP) lamp	1(one color: green)
Port	
Network port	two RJ45 ports, compatible with 100BASE-TX standard
AC power input port	1,supporting voltage input:100~240VAC(±10%),frequency input: 50Hz(±3Hz) or 60Hz(±3Hz)
Button	
Reset button	1

A.5.5 Central Charger

Charger slot	10
LED	10, which indicates the battery charge status.

AC power indicator	1
Installation mode	Place on the desktop, or mount on GCX® wall channel.

A.6 Data Storage

The telemetry monitor stores data as below:

- Most recent 48 hours of tabular trends for all parameters at the trend interval equal to or greater than 1 minute.
- Up to 200 events
- Up to two-hour full disclosure waveforms of ECG I, II, III, and V/Va leads

A.7 Wireless Specification

A.7.1 Mindray Patient Area Network (MPAN) Specification

A.7.1.1 Technical Specification

Protocol standard	Bluetooth low energy 4.0
Modulation mode	GFSK
Operating frequency	2402 MHz to 2480 MHz
Channel spacing	2 MHz
Wireless baud rate	1 Mbps
Output power	≤ 2.5 mW
Data Security	Private protocol

A.7.1.2 Implemented Function

This function is provided to transfer configuration information between the TM70 and to perform communication between a TM70 and a BP10.

BP10 transmits NIBP parameters, status, and prompt messages to the TM70. The TM70 transmits control information and settings information to the BP10.

A.7.1.3 Function Specification

Data integrity	Code error rate ≤ 1%
-----------------------	----------------------

Data latency	Total delay of data transmission from BP10 to the TM70 or from the TM70 to BP10: ≤ 3 second Total delay of data transmission from the TM70 to the CMS: ≤ 3 seconds
Priority	All communication data type shall have the same priority.
Transmission distance	Distinct vision distance between the TM70s is no less than 3 m Distinct vision distance between the TM70s and the BP10 is no less than 3 m.
System capacity	One TM70 can synchronously transport the device configuration to at least other five the TM70s in a 10 m ² space. Five pairs of the TM70s and BP10s can communicate in a 10 m ² space, with the TM70 communicating with the CMS.
Resistance to wireless interference	The bluetooth function is normal when the distance between the following interfering devices and the TM70 or BP10 are as follows: <ul style="list-style-type: none"> ■ > 1 m for microwave ovens. ■ > 0.2 m for cellular communication devices, wireless devices, intercoms, and cordless phones.
Communication interruption message	When the bluetooth communication is interrupted, the TM70 displays a prompt message.

A.7.2 WMTS Specifications

A.7.2.1 Technical Specification

Specifications	608M	1.4G
Modulation mode	GFSK	
Operating frequency	608MHz(608~614MHz)	1.4GHz(1395~1400MHz and 1427~1432MHz)
Channel spacing	600kHz	800kHz or 600kHz
Wireless baud rate (data rate)	Max 400kbps	Max 433kbps for 800kHz channel spacing; Max 400kbps for 600kHz channel spacing.
Max. Output power	10 dBm	
Receiver sensitivity	≤-90 dBm for AP70 ≤-87 dBm for TM70	

Data security	authentication: based on TLS ; encryption : AES-128bit	
Radio Frequency Accuracy during normal operation	(-50,+50) KHz relative to channel frequency	
Occupied bandwidth as defined by power in 99% bandwidth	(-300,+300) KHz	(-400,+400) KHz

A.7.2.2 Implemented Function

TM70 transmits waveforms, parameters, status and alarms of ECG, SPO2, RESP and parameters, status and alarms of NIBP to the central station. The waveforms, parameters, status and alarms displayed on central station are consistent with TM70.

TM70 can work well with AP70s which support POE, if the RSSI from AP70s is higher than -70 dBm.

A.7.2.3 Function Specifications

WARNING

- **Do perform all network functions of data communication within an enclosed network.**
-
-

Specifications	608M	1.4G
Data integrity	The time percentage when a TM70 fails to transmit data to the central station shall not exceed 0.1% over a 24-hour period.	
Data latency	Total delay of data transmitted from the TM70 to the central station: ≤ 3 s.	
Transmission distance	Distinct vision distance from the TM70 to the AP70 shall be no less than 50 m for LOS.	
Roaming	The network switchover is automatically implemented when TM70 moves from the coverage area of one AP70 to the coverage area of another AP70.	

<p>System capacity</p>	<p>Number of TM70s supported by a single AP70: 14 for 5-lead ECG and 12 for 6-lead ECG.</p> <p>Every TM70 can communicate with the central station.</p>	<p>Number of TM70s supported by a single AP70:</p> <ul style="list-style-type: none"> ■ 16 for 800kHz channel spacing & 5-lead ECG ■ 14 for 800kHz channel spacing & 6-lead ECG ■ 14 for 600kHz channel spacing & 5-lead ECG ■ 12 for 600kHz channel spacing & 6-lead ECG <p>Each TM70 can communicate with the central station.</p>
<p>Resistance to wireless interference¹</p>	<p>When the distance between interfering devices and TM70 transmitter is farther than 20cm and the co-channel interference WMTS network (should be no greater than -85dBm) and an adjacent-channel WMTS network (adjacent-channel power should be no greater than -40dBm@1.2MHz) also exist, the TM70 does not encounter network interruption alarm event.</p> <p>Note: the interfering devices includes:</p> <ul style="list-style-type: none"> • Wireless equipment operated at 2.4GHz • Cellular communication devices • Microwave ovens • Cordless phones 	
<p>Dynamic networking stability</p>	<p>When TM70 is moving at the rate of no more than 3.75 m/s within a 15m non-blocking linear distance, it does not encounter network interruption alarm event.</p>	
<p>Network interruption alarm</p>	<p>When the network interruption occurs, the central station initiates the related alarms in 8s.</p> <p>When the network is reconnected, wireless connection recovers automatically.</p>	
<p>Wireless networking stability</p>	<p>The ratio of the communication data lost on the center station from the TM70 is less than 0.1% in 24 hours under the following circumstances: Each of the TM70 roams 30 times and at least 3 TM70s roam simultaneously.</p>	

¹: In the application scenario, the most serious interference source is other WMTS telemetry products not from MINDRAY. To make sure TM70 works well, user should make sure the separation distance between TM70 (or AP70) and the unintended interference devices be longer than the distance shown below:

Working Frequency Band	Interference Devices	Separation Distance Between TM70 and Interference Devices	Separation Distance Between AP70 and Interference Devices
608MHz (608-614MHz)	Adjacent	5.5m	6m
	Co-channel	20m	20m
1.4G (1395-1400MHz)	Adjacent	5.5m	6m
	Co-channel	21m	25m
1.4G (1427-1432MHz)	Adjacent	5.5m	6m
	Co-channel	21m	25m

A.8 Measurement Specifications

A.8.1 ECG

ECG	
Standard	Meet standards of IEC60601-2-27
Leadset	3-lead: I, II, III 5-lead: I, II, III, aVR, aVL, aVF, V 6-lead: I, II, III, aVR, aVL, aVF, Va, Vb Automatic 3/5/6- lead recognition
ECG standard	AHA, IEC
Sweep speed	6.25 mm/s, 12.5 mm/s, 25 mm/s Accuracy: $\pm 10\%$
Display Sensitivity	1.25 mm/mV ($\times 0.125$), 2.5 mm/mV ($\times 0.25$), 5 mm/mV ($\times 0.5$), 10 mm/mV ($\times 1$), 20 mm/mV ($\times 2$), 40 mm/mV ($\times 4$) Accuracy: $\pm 5\%$
Input signal range	± 8 mV (peak-to-peak value)
Calibration signal	1 mV (peak-to-peak value) Accuracy: $\pm 5\%$
Differential input impedance	≥ 5 M Ω
Bandwidth (-3dB)	Monitor mode: 0.5 Hz to 40 Hz ST mode: 0.05 Hz to 40 Hz

Common mode rejection ratio (with Notch off)	Monitor mode: > 105 dB ST mode: > 105 dB
Notch	50/60 Hz, rejection capacity \geq 20 dB
Polarizing voltage scope	\pm 500 mV
Noise	\leq 30 μ V (p-v RTI)
Baseline recovery time	< 5 s (after defibrillation)
Direct current leakage	Input electrode: < 0. 1 μ A Drive electrode: <1 μ A
Electrode polarization recovery time	< 10 s
Defibrillation energy absorption	\leq 10% (100 Ω load)
Pace Pulse	
Pace pulse markers	Pace pulses meeting the following conditions are labelled with a PACE marker: Amplitude: \pm 2 mV to \pm 700 mV Width: 0.1 ms to 2 ms Rise time: 10 μ s to 100 μ s Amplitude: \geq 0.2mV RTI
Pace pulse rejection	When tested in accordance with the IEC60601-2-27: 201.12.1.101.13, the heart rate meter rejects all pulses meeting the following conditions. Amplitude: \pm 2 mV to \pm 700 mV Width: 0.1 ms to 2 ms Rise time: 10 μ s to 100 μ s No overshoot
HR	
Measurement range	Adult: 15 bpm to 300 bpm Pediatric: 15 bpm to 350 bpm
Resolution	1 bpm
Accuracy	\pm 1 bpm or \pm 1%, whichever is greater.
Sensitivity	160 μ V (accuracy range: 0.16 mV to 0.21 mV.)

HR averaging method	<p>In compliance with the requirements in Clause 201.7.9.2.9.101 b) 3) of IEC60601-2-27, the following method is used:</p> <p>If the last 3 consecutive RR intervals are greater than 1200 ms, the 4 most recent RR intervals are averaged to compute the HR. Otherwise, heart rate is computed by subtracting the maximum and minimum ones from the most recent 12 RR intervals and then averaging them.</p> <p>The HR value displayed on the monitor screen is updated every second.</p>
Tall T-wave rejection capability	<p>When the test is performed based on Clause 201.7.9.2.9.101 b) 2) of IEC60601-2-27, the heart rate meter will reject all 100 ms QRS complexes with less than 1.2 mV of amplitude, and T waves with T-wave interval of 180 ms and those with Q-T interval of 350 ms.</p>
Response time to heart rate change	<p>Meets the requirements of IEC60601-2-27: Clause 201.7.9.2.9.101 b) 5).</p> <p>From 80 bpm to 120 bpm: less than 11 s</p> <p>From 80 bpm to 40 bpm: less than 11 s</p>
Response to irregular rhythm	<p>In compliance with the requirements in Clause 201.7.9.2.9.101 b) 4) of IEC60601-2-27, the heart rate after 20 seconds of stabilization is displayed as follows:</p> <p>Ventricular bigeminy (3a): 80 ± 1 bpm</p> <p>Slow alternating ventricular bigeminy (3b): 60 ± 1 bpm</p> <p>Rapid alternating ventricular bigeminy (3c): 120 ± 1 bpm</p> <p>Bidirectional systoles (3d): 90 ± 2 bpm</p>
Time to alarm for tachycardia	<p>Meets the requirements of IEC60601-2-27: Clause 201.7.9.2.9.101 b) 6).</p> <p>Waveform</p> <p>B1h - range: < 11 s</p> <p>B1 - range: < 11 s</p> <p>B1d - range: < 11 s</p> <p>B2h - range: < 11 s</p> <p>B2 - range: < 11 s</p> <p>B2d - range: < 11 s</p>
ST Segment Analysis	
Measurement range	-2.0 mV to +2.0 mV RTI
Resolution	0.01 mV

Accuracy	-0.8 mV to +0.8 mV: ± 0.02 mV or $\pm 10\%$, whichever is greater Beyond this range: Not specified
Arrhythmia Analysis	
Arrhythmia analysis classifications	Asystole, V-Fib/V-Tach, V-Tach, Vent Brady, Extreme Tachy, Extreme Brady, PVCs/min, Pauses/min, R on T, Run PVCs, Couplet, Multiform PVC, PVC, Bigeminy, Trigeminy, Tachy, Brady, Pacer Not Pacing, Pacer Not Capture, Missed Beats, Nonsus V-Tach, Vent Rhythm, Pause, Irr Rhythm, A-Fib
QT Analysis	
QTc formula	Bazett, Fridericia, Framingham, and Hodges
QT measurement range	200 ms to 800 ms
QT accuracy	200 ms to 800 ms: ± 30 ms Beyond this range: Not specified
QT resolution	200 ms to 800 ms: 4 ms Beyond this range: Not specified
QTc measurement range	200 ms to 800 ms
QTc resolution	200 ms to 800 ms: 1 ms Beyond this range: Not specified
QT-HR measurement range	Adult: 15 bpm to 150 bpm Pediatric: 15 bpm to 180 bpm

A.8.2 Resp

Resp	
Technique	Trans-thoracic impedance
Lead	Lead II
Respiration excitation waveform	<300 μ A RMS, 32kHz ($\pm 10\%$)
Baseline impedance range	200 Ω to 2500 Ω
Bandwidth	0.2 Hz to 2.5 Hz (-3 dB)
Sweep speed	3mm/s, 6.25 mm/s, 12.5 mm/s, 25 mm/s

Respiration Rate	
Measurement range	Adult: 0 rpm to 120 rpm Pediatric: 0 rpm to 150 rpm
Resolution	1 rpm
Accuracy	7 rpm to 150 rpm: ± 2 rpm or $\pm 2\%$, whichever is greater 0 rpm to 6 rpm: Not specified
NCM alarm delay	10s, 15s, 20s, 25s, 30s, 35s, 40s

A.8.3 SpO₂

NOTE

- A functional tester or SpO₂ simulator can be used to determine the pulse rate accuracy.

A.8.3.1 Masimo SpO₂ Module

SpO ₂	
Measurement range	1% to 100%
Resolution	1%
Accuracy*	70-100%: $\pm 2.0\%$ (measured without motion) 70-100%: $\pm 3.0\%$ (measured with motion) 1-69%: Not specified
Low Perfusion Conditions	Pulse amplitude: $> 0.02\%$ Light penetration: $> 5\%$ Accuracy: $\pm 2\%$
Data update rate	$\leq 2s$
<p>*SpO₂ accuracy was determined by testing on healthy adult volunteers in the range of 60% to 100% SpO₂ against a laboratory CO-Oximeter. SpO₂ accuracy was determined on 16 neonatal NICU patients ranging in age from 7-135 days old and weighing between 0.5-4.25 kg. Seventy-nine (79) data samples were collected over range of 70-100% SaO₂ with a resultant accuracy of 2.9% SpO₂.</p> <p>The following table shows the accuracy (A_{rms}) for the SpO₂ sensors in four kinds of SaO₂ ranges. For the Fitting Curve of the SpO₂ sensors, refer to A.8.3.2 Fitting Curve for Masimo SpO₂ Sensors.</p>	

SaO ₂ range	Measured A _{rms} Values	
	LNCS A _{dtx} , LNCS P _{dtx} , RD SET A _{dt} , RD SET P _{dt}	LNCS DCI, LNCS DCIP, RD SET DCI(Adult&Pediatric)
70% to 100%	± 2%	2%
70% to 80%	1.55%	0.60%
80% to 90%	1.07%	0.54%
90% to 100%	1.64%	0.60%
PR		
Measurement range	25 bpm to 240 bpm	
Resolution	1 bpm	
Accuracy	±3.0 bpm(measured without motion) ±5.0 bpm (measured with motion)	
PI		
Measurement range	0.02% to 20%	
Least resolution	0.01, use three valid digits	
Response Time		
■	≤ 25 s (PR 75 bpm, average time 8 s, no disturbance, SpO ₂ value rises from 50% to 100%)	
■	≤ 20 s (SpO ₂ value 98%, average time 8 s, no disturbance, PR value rises from 60 bpm to 150 bpm)	

A.8.3.2 Fitting Curve for Masimo SpO₂ Sensors

Table information for the plots below show A_{RMS} values measured with Masimo SET Oximetry Technology in a clinical study.

LNCS A_{dtx}/ LNCS P_{dtx}/RD SET A_{dt}/RD SET P_{dt}

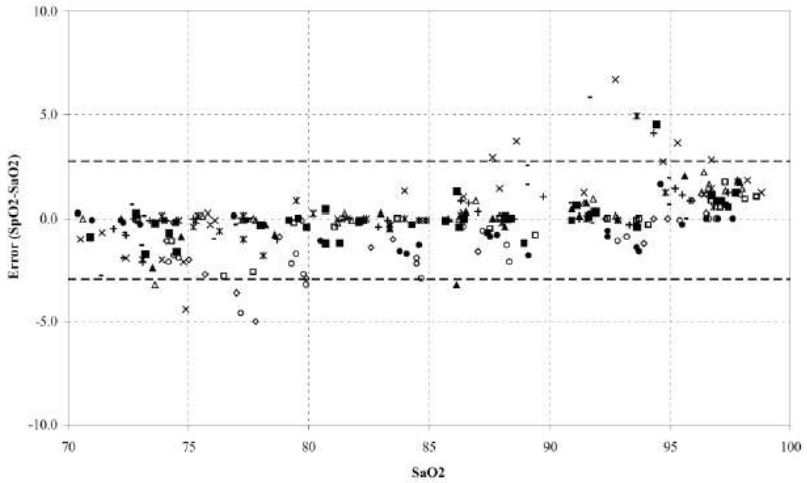

LNCS DCI/LNCS DCIP/RD SET DCI(Adult&Pediatric)

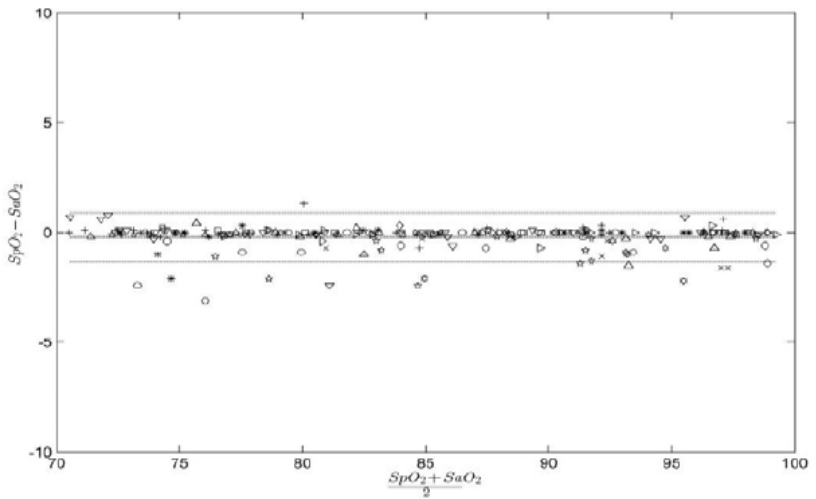

A.8.3.3 Nellcor SpO₂ Module

SpO₂	
Measurement range	0% to 100%

Resolution	1%
Accuracy	70-100%: ± 2 ABS 60-80%: ± 3 ABS 0-59%: Not specified
Data update rate	$\leq 2s$
PR	
Measurement range	20 bpm to 300 pm
Accuracy	20 bpm to 250 bpm: ± 3 bpm 251 bpm to 300 bpm: Not specified

A.8.3.4 Fitting Curve for Nellcor SpO₂ Sensors

■ SpO₂ Accuracy for Nellcor Sensors vs. Co-Oximeters (Arms)

SpO ₂ Range	100% to 70%	100% to 90%	89% to 80%	79% to 70%
DS-100A	1.64%	1.16%	1.67%	2.25%
D-YS, OXI-P/I	2.41%	1.38%	2.50%	3.60%

■ Modified Bland-Altman for SpO₂-DS-100A Sensor: (SpO₂ - SaO₂) vs. SaO₂

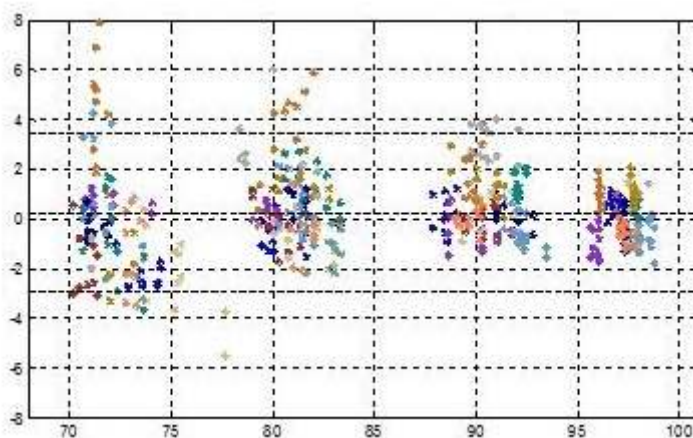

■ Modified Bland-Altman for SpO₂-D-YS, OXI-P/I Sensors: (SpO₂ - SaO₂) vs. SaO₂

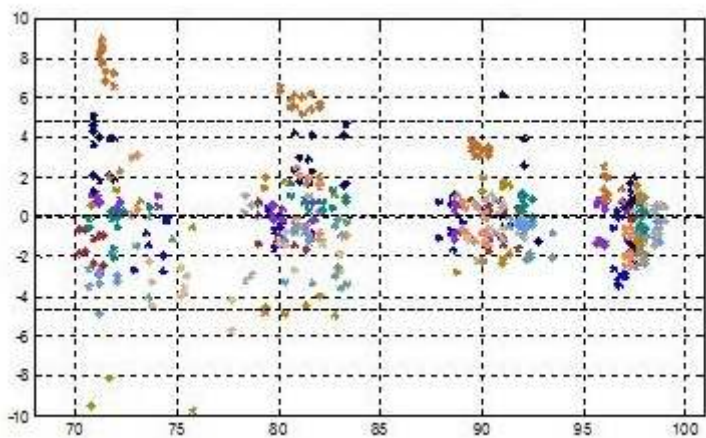

B EMC

B.1 EMC

The device meets the requirements of IEC 60601-1-2: 2014.

WARNING

- **Use of accessories, transducers and cables other than those specified or provided by the manufacturer of this device could result in increased electromagnetic emissions or decreased electromagnetic immunity of this device and result in improper operation.**
 - **Use of this device adjacent to or stacked with other device should be avoided because it could result in improper operation. If such use is necessary, this device and the other device should be observed to verify that they are operating normally.**
 - **Portable RF communications equipment (including peripherals such as antenna cables, external antennas, and RF ID equipment) should be used no closer than 20 cm to any part of the this device, including cables specified by the manufacturer. Otherwise, degradation of the performance of this equipment could result.**
 - **The non-ME EQUIPMENT (e.g. ITE) that is a part of an ME SYSTEM may be disrupted by the electromagnetic interference of nearby equipment. It may be necessary to take mitigation measures, such as re-orienting or relocating the non-ME EQUIPMENT or shielding the location.**
 - **This device is intended for use in professional healthcare facility environment. If it is used in special environment, such as magnetic resonance imaging environment, the equipment/system may be disrupted by the operation of nearby equipment.**
-
-

Guidance and Declaration - Electromagnetic Emissions		
The device is intended for use in the electromagnetic environment specified below. The customer or the user of the device should assure that it is used in such an environment.		
Emissions test	Compliance	Electromagnetic environment — guidance

RF emissions CISPR 11	Group 1	The system uses RF energy only for its internal function. Therefore, its RF emissions are very low and are not likely to cause any interference in nearby electronic equipment.
RF emissions CISPR 11	Class B*	Only telemetry monitor and BP10 (subpart) complies. The devices are suitable for use in all establishments, including domestic establishments and those directly connected to the public low voltage power supply network that supplies buildings used for domestic purposes.
RF emissions CISPR 11	Class A	Devices in the telemetry monitoring system except TM70 and BP10 complies. The devices are suitable for use in all establishments other than domestic and those directly connected to the public low-voltage power supply network that supplies buildings used for domestic purposes.
Harmonic distortion IEC 61000-3-2	Class A	
Voltage fluctuations and flicker IEC 61000-3-3	Compliance	
Note: The TM70 Telemetry Monitoring System and BP10 (subpart) are classified by is their using environment or intended function.		

NOTE

- **The device needs special precautions regarding EMC and needs to be installed and put into service according to the EMC information provided below.**
- **Other devices may affect this device even though they meet the requirements of CISPR.**
- **When the inputted signal is below the minimum amplitude provided in technical specifications, erroneous measurements could result.**
- **The EMISSIONS characteristics of this device make it suitable for use in industrial areas and hospitals (CISPR 11 class A). If it is used in a residential environment (for which CISPR 11 class B is normally required) this device might not offer adequate protection to radio-frequency communication services. The user might need to take mitigation measures, such as relocating or re-orienting the device.**
- **If the essential performance is lost or degraded, it may be necessary to take mitigation measures, such as re-orienting or relocating the ME EQUIPMENT or ME SYSTEM or shielding the location or stopping using the monitor and contact the service personnel.**

If the system is operated within the electromagnetic environment listed in Table Guidance and declaration — electromagnetic immunity, the system will provide the following essential performance:

■ Operating mode

No cessation or interruption of any intended operation.

■ Accuracy

The change of the parameter's numerical value shall not exceed the specified accuracy.

■ Function

Each function of patient monitor shall work as intended, including the parameter, screen and touch screen.

■ Accessories identification

The accessories shall be identified normally.

■ Data stored

Trend data and events shall be able to be reviewed.

■ Alarm

The monitor shall provide alarm or alarm signal as intended, with no false alarm.

■ Detect for connection

The connection status shall be detected normally.

■ Wireless

The system shall be able to detect: network connection, data transmission and caution for disconnection.

Guidance and Declaration - Electromagnetic Immunity			
The device is intended for use in the electromagnetic environment specified below. The customer or the user of the device should assure that it is used in such an environment.			
Immunity test	IEC 60601 Test level	Compliance level	Electromagnetic environment - guidance
Electrostatic Discharge (ESD) IEC 61000-4-2	±8 kV contact ±15kV air	±8 kV contact ±15kV air	Floors should be wood, concrete or ceramic tile. If floors are covered with synthetic material, the relative humidity should be at least 30%.

Electrical fast transient/ burst IEC 61000-4-4	±2 kV for power supply lines ±1 kV for input/output lines (length greater than 3 m)	±2 kV for power supply lines ±1 kV for input/output lines (length greater than 3 m)	Mains power quality should be that of a typical commercial or hospital environment.
Surge IEC 61000-4-5	±1 kV line(s) to line(s) ±2 kV line(s) to earth	±1 kV line(s) to line(s) ±2 kV line(s) to earth	
Voltage dips and Voltage interruptions IEC 61000-4-11	0 % U_T for 0,5 cycle 0 % U_T for 1 cycle and 70 % U_T for 25/30 cycles 0 % U_T for 250/300 cycle	0 % U_T for 0,5 cycle 0 % U_T for 1 cycle and 70 % U_T for 25/30 cycles 0 % U_T for 250/300 cycle	Mains power quality should be that of a typical commercial or hospital environment. If the user of our product requires continued operation during power mains interruptions, it is recommended that our product be powered from an uninterruptible power supply or a battery.
RATED power frequency magnetic fields IEC 61000-4-8	30 A/m 50 Hz / 60 Hz	30 A/m 50 Hz / 60 Hz	Power frequency magnetic fields should be at levels characteristic of a typical location in a typical commercial or hospital environment.

Note: U_T is the A.C. mains voltage prior to application of the test level.

Guidance and Declaration - Electromagnetic Immunity

The device is intended for use in the specified electromagnetic environment. The customer or the user of the device should assure that it is used in such an environment as described below.

Immunity test	IEC 60601 Test level	Compliance level	Electromagnetic environment - guidance
---------------	----------------------	------------------	--

Conducted disturbances induced by RF fields IEC61000-4-6	3 Vrms 150 kHz to 80 MHz	3 Vrms	<p>Portable and mobile RF communications equipment should be used no closer to any part of the device, including cables, than the recommended separation distance calculated from the equation applicable to the frequency of the transmitter. Recommended separation distance:</p> $d = \left[\frac{3.5}{V} \right] \sqrt{P} \quad 150\text{kHz to } 80 \text{ MHz}$ $d = \left[\frac{3.5}{E} \right] \sqrt{P} \quad 80 \text{ MHz to } 800 \text{ MHz}$ $d = \left[\frac{7}{E} \right] \sqrt{P} \quad 800 \text{ MHz to } 2.7 \text{ GHz}$ <p>where P is the maximum output power rating of the transmitter in watts (W) according to the transmitter manufacturer and d is the recommended separation distance in meters (m).</p> <p>Field strengths from fixed RF transmitters, as determined by an electromagnetic site survey, should be less than the compliance level in each frequency range.</p> <p>Interference may occur in the vicinity of equipment marked with the following symbol : </p>
	6 Vrms in ISM bands and amateur radio bands between 0,15 MHz and 80 MHz	6 Vrms	
Radiated RF EM fields IEC61000-4-3	10V/m 80 MHz to 2.7 GHz	10V/m(TM70 and BP10)	
Radiated RF EM fields IEC61000-4-3	3V/m 80 MHz to 2.7 GHz	3V/m(TM70 System)	
Proximity fields from RF wireless communications equipment IEC61000-4-3	27 V/m 380–390 MHz	27 V/m	
	28 V/m 430–470 MHz, 800–960 MHz, 1700–1990 MHz, 2400–2570 MHz	28 V/m	
	9 V/m 704–787 MHz, 5100–5800 MHz	9 V/m	
<p>Note 1: At 80 MHz and 800 MHz, the higher frequency range applies.</p> <p>Note 2: These guidelines may not apply in all situations. Electromagnetic propagation is affected by absorption and reflection from structures, objects and people.</p>			

a The ISM (industrial, scientific, and medical) bands between 150 kHz and 80 MHz are 6.765 MHz to 6.795 MHz; 13.553 MHz to 13.567 MHz; 26.957 MHz to 27.283 MHz; and 40.66 MHz to 40.70 MHz. The

amateur radio bands between 0,15 MHz and 80 MHz are 1,8 MHz to 2,0 MHz, 3,5 MHz to 4,0 MHz, 5,3 MHz to 5,4 MHz, 7 MHz to 7,3 MHz, 10,1 MHz to 10,15 MHz, 14 MHz to 14,2 MHz, 18,07 MHz to 18,17 MHz, 21,0 MHz to 21,4 MHz, 24,89 MHz to 24,99 MHz, 28,0 MHz to 29,7 MHz and 50,0 MHz to 54,0 MHz.

b Field strengths from fixed transmitters, such as base stations for radio (cellular/cordless) telephones and land mobile radios, amateur radio, AM and FM radio broadcast and TV broadcast cannot be predicted theoretically with accuracy. To assess the electromagnetic environment due to fixed RF transmitters, an electromagnetic site survey should be considered. If the measured field strength in the location in which the device is used exceeds the applicable RF compliance level above, the device should be observed to verify normal operation. If abnormal performance is observed, additional measures may be necessary, such as re-orienting or relocating the device.

c Over the frequency ranges 150 kHz to 80 MHz, field strengths should be less than 3V/m.

Recommended Separation Distances between Portable and Mobile RF, Communications Equipment and This Equipment

The equipment is intended for use in an electromagnetic environment in which radiated RF disturbance are controlled. The customer or the user of the device can help prevent electromagnetic interference by maintaining a minimum distance between portable and mobile RF communications equipment (transmitters) and the device as recommended below, according to the maximum output power of the communication equipment.

Rated Maximum Output power of Transmitter Watts (W)	Separation Distance According to Frequency of Transmitter (m)		
	150kHz -80MHz $d = \left[\frac{3.5}{V} \right] \sqrt{P}$	80MHz to 800MHz $d = \left[\frac{3.5}{E} \right] \sqrt{P}$	800MHz to 2.7GHz $d = \left[\frac{7}{E} \right] \sqrt{P}$
0.01	0.12	0.12	0.23
0.1	0.38	0.38	0.73
1	1.2	1.2	2.3
10	3.8	3.8	7.3
100	12	12	23

For telemetry monitors at a maximum output power not listed above, the recommended separation distanced in meters (m) can be determined using the equation applicable to the frequency of the transmitter, where P is the maximum output power rating of the transmitter in watts (W) according to the transmitter manufacturer.

Note 1: At 80 MHz and 800 MHz, the higher frequency range applies.

Note 2: These guidelines may not apply in all situations. Electromagnetic propagation is affected by absorption and reflection from structures, objects and people.

C FCC Compliance

The telemetry monitor complies with the requirements of FCC Part 95:

Radio frequency Radiation Exposure Information

For body worn operation, this equipment has been tested and meets the FCC and CE RF exposure guidelines when used with the accessories supplied or those approved for use with this product. Use of other accessories may not ensure compliance with FCC and CE RF exposure guidelines within 32 kilometers of the National Radio Astronomy Observatory centered on:

Very long baseline array stations	Latitude (north)	Longitude (west)
Pie Town, NM	34°18'	108°07'
Kitt Peak, AZ	31°57'	111°37'
Los Alamos, NM	35°47'	106°15'
Fort Davis, TX	30°38'	103°57'
North Liberty, IA	41°46'	91°34'
Brewster, WA	48°08'	119°41'
Owens Valley, CA	37°14'	118°17'
Saint Croix, VI	17°46'	64°35'
Mauna Kea, HI	19°49'	155°28'
Hancock, NH	42°56'	71°59'

If the installation distance is not enough, obtain the written concurrence of the Director of the affected radio astronomy station before the equipment can be installed or operated.

RF parameter (Bluetooth Module)(Panlink2 Module)

Protocol	Bluetooth low energy 4.0
Operating frequency band	2402 MHz to 2480 MHz
Modulation mode	GFSK
Output power	≤2.5 mW

RF parameter (WMTS Module) for TM70 and AP70

Operating frequency band	<ul style="list-style-type: none"> ■ 608~614MHz ■ 1395~1400MHz and 1427~1432MHz
Modulation mode	GFSK
Output Power	<10 dBm (peak power)

Operation of this equipment requires the prior coordination with a frequency coordinator designated by the FCC for the Wireless Medical Telemetry Service. This equipment here refers to TM70 or AP70.

The device including Wireless module complies with part 15 of the FCC Rules. Operation is subject to the condition that this device does not cause harmful interference.

D Symbols and Abbreviations

D.1 Units

A	ampere
Ah	ampere hour
bpm	beats per minute
°C	centigrade
cc	cubic centimeter
cm	centimeter
dB	decibel
DS	dyne. second
°F	fahrenheit
g	gram
hr	hour
hPa	hundred pascal
Hz	hertz
in	inch
k	kilo
kg	kilogram
kPa	kilopascal
l	litre
lb	pound
m	meter
mg	milligrams
min	minute
ml	milliliter
mm	millimeters
ms	millisecond
mV	millivolt
mW	milliwatt
nm	nanometer
ppm	part per million

s	second
V	volt
VA	volt ampere
Ω	ohm
μA	microampere
μm	micron
μV	microvolt
W	watt

D.2 Symbols

-	minus
%	percent
/	per; divide; or
^	power
+	plus
=	equal to
<	less than
>	greater than
\leq	less than or equal to
\geq	greater than or equal to
\pm	plus or minus
\times	multiply
©	copyright

D.3 Abbreviations

AAMI	Association for Advancement of Medical Instrumentation
AC	alternating current
AHA	American Heart Association
ANSI	American National Standard Institute
ARR	arrhythmia
ART	arterial

AUX	Auxiliary output
aVF	left foot augmented lead
aVL	left arm augmented lead
aVR	right arm augmented lead
CH	channel
CISPR	International Special Committee on Radio Interference
CMS	central monitoring system
ECG	electrocardiograph
EMC	electromagnetic compatibility
err	error
ES	electrosurgical
ESU	electrosurgical unit
HR	heart rate
HT	height
IEC	International Electrotechnical Commission
ISO	International organization for standardization
MRI	magnetic resonance imaging
LA(L)	left arm
LAP	left atria pressure
LED	light emitting diode
LL(F)	left leg
Loop	loop read-write test fail
M, MEAN	mean pressure
O ₂	oxygen
P	power
PR	pulse rate
QRS	interval of ventricular depolarization (QRS complex)
RA(R)	right arm
RL(N)	right leg
ROM	read-only memory
SpO ₂	arterial oxygen saturation from pulse oximetry
VGA	Video Graphics Array

This page intentionally left blank.

