

SV800

Ventilator

Operator's Manual



© 2017-2019 Shenzhen Mindray Bio-Medical Electronics Co., Ltd. All rights Reserved.

For this Operator's Manual, the issue date is December, 2019.

Intellectual Property Statement

SHENZHEN MINDRAY BIO-MEDICAL ELECTRONICS CO., LTD. (hereinafter called Mindray) owns the intellectual property rights to this Mindray product and this manual. This manual may refer to information protected by copyright or patents and does not convey any license under the patent rights or copyright of Mindray, or of others.

Mindray intends to maintain the contents of this manual as confidential information. Disclosure of the information in this manual in any manner whatsoever without the written permission of Mindray is strictly forbidden. Release, amendment, reproduction, distribution, rental, adaptation, translation or any other derivative work of this manual in any manner whatsoever without the written permission of Mindray is strictly forbidden.

mindray,  and **MINDRAY** are the trademarks, registered or otherwise, of Mindray in China and other countries. All other trademarks that appear in this manual are used only for informational or editorial purposes. They are the property of their respective owners.

Responsibility on the Manufacturer Party

Contents of this manual are subject to change without prior notice.

All information contained in this manual is believed to be correct. Mindray shall not be liable for errors contained herein or for incidental or consequential damages in connection with the furnishing, performance, or use of this manual.

Mindray is responsible for the effects on safety, reliability and performance of this product, only if:

- all installation operations, expansions, changes, modifications and repairs of this product are conducted by Mindray authorized personnel;
- the electrical installation of the relevant room complies with the applicable national and local requirements; and
- the product is used in accordance with the instructions for use.



WARNING

- **It is important for the hospital or organization that employs this equipment to carry out a reasonable service/maintenance plan. Neglect of this may result in machine breakdown or personal injury.**
-

NOTE

- **This equipment must be operated by skilled/trained clinical professionals.**
-

Warranty

THIS WARRANTY IS EXCLUSIVE AND IS IN LIEU OF ALL OTHER WARRANTIES, EXPRESSED OR IMPLIED, INCLUDING WARRANTIES OF MERCHANTABILITY OR FITNESS FOR ANY PARTICULAR PURPOSE.

Exemptions

Mindray's obligation or liability under this warranty does not include any transportation or other charges or liability for direct, indirect or consequential damages or delay resulting from the improper use or application of the product or the use of parts or accessories not approved by Mindray or repairs by people other than Mindray authorized personnel.

This warranty shall not extend to:

- Malfunction or damage caused by improper use or man-made failure.
- Malfunction or damage caused by unstable or out-of-range power input.
- Malfunction or damage caused by force majeure such as fire and earthquake.
- Malfunction or damage caused by improper operation or repair by unqualified or unauthorized service people.
- Malfunction of the instrument or part whose serial number is not legible enough.
- Others not caused by instrument or part itself.

Customer Service Department

Manufacturer: Shenzhen Mindray Bio-Medical Electronics Co., Ltd.
Address: Mindray Building, Keji 12th Road South, High-tech industrial park, Nanshan, Shenzhen 518057, P.R. China
Website: www.mindray.com
E-mail Address: service@mindray.com
Tel: +86 755 81888998
Fax: +86 755 26582680

EC-Representative: Shanghai International Holding Corp. GmbH (Europe)
Address: Eiffestraße 80, 20537 Hamburg, GERMANY
Tel: 0049-40-2513175
Fax: 0049-40-255726

Preface

Manual Purpose

This manual contains the instructions necessary to operate the product safely and in accordance with its function and intended use. Observance of this manual is a prerequisite for proper product performance and correct operation and ensures patient and operator safety.

This manual is based on the maximum configuration and therefore some contents may not apply to your product. If you have any question, please contact us.

This manual is an integral part of the product. It should always be kept close to the equipment so that it can be obtained conveniently when needed.

Intended Audience

This manual is geared for clinical professionals who are expected to have a working knowledge of medical procedures, practices and terminology as required for monitoring of critically ill patients.

Illustrations

All illustrations in this manual serve as examples only. They may not necessarily reflect the setup or data displayed on your ventilator.

Conventions

- *Italic* text is used in this manual to quote the referenced chapters or sections.
- [] is used to enclose screen texts.
- → is used to indicate operational procedures.

Password

A password is required to access different menus within the ventilator.

- System menu: 1234

Table of Contents

1 Safety	1-1
1.1 Safety Information	1-1
1.1.1 DANGER	1-2
1.1.2 WARNING	1-2
1.1.3 CAUTION	1-6
1.1.4 NOTE	1-8
1.2 Equipment Symbols	1-8
2 The Basics	2-1
2.1 System Description	2-1
2.1.1 Intended Use	2-1
2.1.2 Contraindications	2-1
2.1.3 Components	2-1
2.2 Equipment Appearance	2-2
2.2.1 Front View	2-2
2.2.2 Rear View	2-4
2.2.3 Air Compressor	2-6
3 Installations and Connections	3-1
3.1 Connect the Power Supply	3-1
3.2 Connect the Pipeline Supply	3-2
3.3 Install the Gas Cylinder	3-4
3.4 Install the Support Arm	3-5
3.5 Install the Patient Tubing	3-7
3.5.1 Install Adult/Pediatric Tubing	3-8
3.5.2 Install Neonate Tubing	3-9
3.6 Install the Humidifier	3-11
3.6.1 Install the Humidifier onto the Ventilator	3-11
3.6.2 Install the Humidifier onto the Pendant	3-13
3.7 Install the Nebulizer	3-14
3.7.1 Install Pneumatic Nebulizer	3-15
3.7.2 Install Electronic Nebulizer	3-16
3.8 Install the Oxygen Sensor	3-17
3.8.1 O ₂ Cell	3-17
3.8.2 Paramagnetic O ₂ Sensor	3-18
3.9 Install Module	3-19
4 User Interface	4-1
4.1 Display Controls	4-1
4.2 Waveforms Screen	4-5

4.2.1 Graphic trend.....	4-6
4.2.2 PulmoSight.....	4-6
4.2.3 AMV Sight.....	4-7
4.3 Spirometry Screen.....	4-8
4.4 Measured Values Screen.....	4-11
4.5 Big Numeric Interface.....	4-11
4.6 History.....	4-12
4.6.1 Graphic Trend.....	4-12
4.6.2 Tabular Trend.....	4-14
4.6.3 Setting Trends.....	4-15
4.6.4 Event Logbook.....	4-16
4.7 Freeze.....	4-17
4.7.1 Enter Freeze Status.....	4-17
4.7.2 View Frozen Waveforms.....	4-17
4.7.3 View Frozen Loop.....	4-18
4.7.4 Exit Freeze Status.....	4-18
4.8 Screen Capture.....	4-19
4.9 Lock Screen.....	4-19
5 System Settings.....	5-1
5.1 Date & Time Settings.....	5-1
5.2 Export to USB.....	5-1
5.2.1 Export Screen.....	5-1
5.2.2 Export Data.....	5-1
5.2.3 Transfer Settings.....	5-2
5.3 Basic Settings.....	5-3
5.3.1 Set Flow/Tpause(%).....	5-3
5.3.2 Set Tinsp/I:E.....	5-3
5.3.3 Set IBW/Height.....	5-3
5.3.4 Set TV/IBW.....	5-4
5.3.5 Setup DuoLevel.....	5-4
5.3.6 Set Invasive Apnea Mode.....	5-4
5.3.7 Set O ₂ % increment during O ₂ ↑ period.....	5-4
5.3.8 Set Oxygen Sensor Monitoring.....	5-5
5.4 Screen Settings.....	5-6
5.4.1 Adjust Screen Brightness.....	5-6
5.4.2 Adjust Key Volume.....	5-6
5.4.3 Screen Setup.....	5-6
5.4.4 Color Settings.....	5-7
5.5 System Settings.....	5-8
5.5.1 Set Language.....	5-8
5.5.2 Set Unit.....	5-8
5.5.3 Set Minimum Alarm Volume.....	5-8
5.5.4 Default Settings.....	5-9

5.5.5 Set Nurse Call	5-10
5.5.6 Set Network.....	5-10
5.5.7 View System Information.....	5-11
5.6 Set Tool Shortcut Key	5-11
5.7 Set Gas Supply	5-11
5.8 Factory Service Settings.....	5-12
6 Start Ventilation.....	6-1
6.1 Turn on the System	6-1
6.2 System Check.....	6-1
6.3 Circuit Test	6-3
6.4 Select Patient.....	6-5
6.4.1 Set Patient Information on the Ventilator	6-5
6.4.2 Getting Patient Information from the ADT Server.....	6-5
6.5 Ventilation Type	6-6
6.5.1 Invasive Ventilation.....	6-6
6.5.2 Non-Invasive Ventilation (NIV).....	6-7
6.5.3 Set Ventilation Type	6-7
6.6 Ventilation Mode.....	6-8
6.6.1 Ventilation Mode and Parameter Setup	6-8
6.6.2 V-A/C	6-10
6.6.3 P-A/C	6-11
6.6.4 V-SIMV	6-12
6.6.5 P-SIMV	6-13
6.6.6 CPAP/PSV	6-14
6.6.7 PSV-S/T.....	6-16
6.6.8 PRVC.....	6-17
6.6.9 PRVC-SIMV	6-18
6.6.10 DuoLevel.....	6-20
6.6.11 APRV	6-21
6.6.12 VS.....	6-22
6.6.13 AMV.....	6-23
6.6.14 CPRV.....	6-25
6.6.15 nCPAP	6-26
6.6.16 Apnea Ventilation	6-27
6.7 Other Ventilation Settings	6-28
6.7.1 Sigh	6-28
6.7.2 Leak Compensation.....	6-29
6.7.3 Automatic Tube Resistance Compensation (ATRC)	6-31
6.7.4 IntelliCycle.....	6-32
6.8 Alarm settings	6-32
6.9 Start Ventilation.....	6-32
6.10 Ventilation Parameters.....	6-33
6.11 Enter Standby Status	6-37

6.12 Turn the System off.....	6-37
7 Neonatal Ventilation.....	7-1
7.1 Safety Information	7-1
7.2 Connecting Patient Tubing to the Flow Sensor.....	7-2
7.3 Circuit Test.....	7-2
7.4 Start Ventilation.....	7-2
7.5 Backup Ventilation.....	7-3
7.6 Set the Monitoring Switch	7-3
7.7 Neonatal Flow Sensor Zeroing.....	7-3
8 CO₂ Monitoring.....	8-1
8.1 Introduction.....	8-1
8.2 CO ₂ Module	8-4
8.3 Sidestream CO ₂ Module.....	8-5
8.3.1 Preparation for Measurement.....	8-5
8.3.2 Make CO ₂ Settings.....	8-6
8.3.3 Measurement Limitations.....	8-8
8.3.4 Troubleshooting.....	8-8
8.3.5 Zero the Sensor	8-8
8.3.6 Calibrate the Sensor	8-8
8.4 Mainstream CO ₂ module.....	8-9
8.4.1 Preparation for Measurement.....	8-9
8.4.2 Make CO ₂ Settings.....	8-10
8.4.3 Measurement Limitations.....	8-11
8.4.4 Zero the Sensor	8-11
8.4.5 Calibrate the Sensor	8-12
9 SpO₂ Monitoring	9-1
9.1 Introduction.....	9-1
9.2 Safety Information	9-2
9.3 Applying the Sensor.....	9-3
9.4 Make SpO ₂ Settings.....	9-3
9.4.1 Set SpO ₂ Monitoring.....	9-3
9.4.2 Set Sensitivity.....	9-3
9.4.3 Beat Volume	9-3
9.4.4 Set CO ₂ Waveform.....	9-3
9.5 Measurement Limitations.....	9-4
10 Special Functions.....	10-1
10.1 Manual Breath.....	10-1
10.2 Expiration Hold.....	10-1
10.3 Inspiration Hold	10-2
10.4 Nebulizer	10-2

10.4.1 Pneumatic Nebulizer	10-3
10.4.2 Electronic Nebulizer.....	10-3
10.5 O ₂ ↑ (Oxygen Enrichment).....	10-4
10.6 Suction	10-5
10.7 P0.1	10-6
10.8 PEEPi	10-6
10.9 NIF	10-7
10.10 Calculation of Alveolar Ventilation	10-7
10.11 P-V Tool	10-8
10.12 Recruitment Tool (SI)	10-10
10.12.1 History.....	10-11
10.13 Weaning Tools.....	10-11
10.13.1 Help Information Viewing.....	10-12
10.13.2 Spontaneous Breathing Trial (SBT).....	10-12
10.13.3 History.....	10-13
10.14 O ₂ Therapy	10-14
10.14.1 Preparing for O ₂ Therapy	10-14
10.14.2 Switching on O ₂ Therapy	10-17
10.14.3 O ₂ Therapy Timing/Timer	10-18
10.14.4 Switching off O ₂ Therapy.....	10-18
10.15 Auxiliary Pressure	10-19
10.15.1 Turn on Auxiliary Pressure.....	10-19
10.15.2 Auxiliary Pressure Zeroing.....	10-19
11 Alarms	11-1
11.1 Introduction	11-1
11.2 Alarm Categories.....	11-2
11.3 Alarm Priority Levels.....	11-2
11.4 Alarm Signals	11-2
11.4.1 Alarm Lamp.....	11-3
11.4.2 Audible Alarm	11-3
11.4.3 Alarm Messages	11-3
11.4.4 Flashing Alarm Numeric	11-3
11.4.5 Alarm Status Symbol.....	11-4
11.5 Alarm Volume Settings.....	11-4
11.6 Set Alarm Limits	11-5
11.6.1 Auto Alarm Limits.....	11-5
11.7 AUDIO PAUSED	11-6
11.7.1 Set AUDIO PAUSED	11-6
11.7.2 Terminate AUDIO PAUSED	11-6
11.8 Current Alarm.....	11-7
11.9 Alarm Chain	11-8
11.10 Recent Alarm.....	11-8
11.11 ALARM OFF	11-9

11.12 Alarm Tests.....	11-10
11.12.1 Battery in Use.....	11-10
11.12.2 Loss of Power.....	11-10
11.12.3 Paw Too High.....	11-10
11.12.4 Paw Too Low.....	11-11
11.12.5 T _{Ve} Too Low.....	11-11
11.12.6 T _{Ve} Too High.....	11-11
11.12.7 MV Too Low.....	11-11
11.12.8 Air Supply Pressure Low.....	11-11
11.12.9 O ₂ Supply Pressure Low.....	11-12
11.12.10 PEEP Too Low.....	11-12
11.12.11 Airway Obstructed.....	11-12
11.12.12 FiO ₂ Too High.....	11-12
11.12.13 FiO ₂ Too Low.....	11-13
11.12.14 EtCO ₂ Too High.....	11-13
11.12.15 EtCO ₂ Too Low.....	11-13
11.12.16 SpO ₂ Too High.....	11-13
11.12.17 SpO ₂ Too Low.....	11-14
11.12.18 SpO ₂ Desat.....	11-14
11.12.19 PR Too High.....	11-14
11.12.20 PR Too LOW.....	11-14
11.13 Nurse Call.....	11-15
11.14 When an Alarm Occurs.....	11-16
12 Cleaning and Disinfection.....	12-1
12.1 Methods for Cleaning and Disinfection.....	12-2
12.2 Disassemble the Ventilator's Cleanable and Disinfectable Parts.....	12-5
12.2.1 Expiration Valve Assembly and Membrane.....	12-5
12.2.2 Inspiration safety valve assembly.....	12-7
12.2.3 HEPA Filter Components and Air Intake Dust Filter.....	12-10
12.2.4 Back air supply cooling fan dust filter.....	12-12
12.2.5 Main Unit Air Outlet Dust Filter.....	12-13
12.2.6 Patient Tubing.....	12-14
12.2.7 Humidifier.....	12-16
12.2.8 Nebulizer.....	12-19
12.2.9 Mainstream CO ₂ Module.....	12-22
13 Maintenance.....	13-1
13.1 Repair Policy.....	13-1
13.2 Maintenance Schedule.....	13-2
13.3 View Preventive Maintenance Items.....	13-4
13.4 Pressure and Flow Zeroing.....	13-5
13.5 Neonatal Flow Sensor Zeroing.....	13-5
13.6 Flow Calibration.....	13-6

13.7 O ₂ % Calibration	13-7
13.8 CO ₂ Calibration.....	13-8
13.8.1 Sidestream CO ₂ Module.....	13-8
13.8.2 Mainstream CO ₂ Module	13-9
13.9 Touch Screen Calibration	13-9
13.10 Battery Maintenance	13-9
13.10.1 Battery Guidelines.....	13-11
13.10.2 Battery Performance Conditioning.....	13-11
13.10.3 Battery Performance Checking	13-12
13.10.4 Battery Storage.....	13-12
13.10.5 Battery Recycling.....	13-13
13.11 Electrical Safety Inspection.....	13-13
13.12 Water Build-up in the Flow Sensor	13-15
13.12.1 Prevent Water Build-up.....	13-15
13.12.2 Clear Water Build-up.....	13-15
14 Accessories	14-1
A Theory of Operation.....	A-1
A.1 Pneumatic Circuit Principle	A-1
A.1.1 Pneumatic Circuit Diagram.....	A-1
A.1.2 Parts List.....	A-2
A.1.3 Definition of Symbols	A-3
A.1.4 Pneumatic System Overview.....	A-4
A.2 Electrical System.....	A-7
A.2.1 Electrical System Structure Diagram	A-7
A.2.2 Parts List.....	A-8
B Product Specifications.....	B-1
B.1 Safety Specifications	B-1
B.2 Environmental Specifications.....	B-2
B.3 Power Requirements.....	B-3
B.4 Physical Specifications.....	B-4
B.5 Pneumatic System Specifications	B-5
B.6 Ventilator Specifications.....	B-7
B.7 Ventilator Accuracy	B-10
B.8 Alarm	B-13
B.8.1 Settable Alarms.....	B-13
B.8.2 Internal Alarms	B-14
B.9 Special Function	B-14
B.10 CO ₂ Module Specifications	B-15
B.10.1 Sidestream CO ₂ Module	B-15
B.10.2 Mainstream CO ₂ Module.....	B-16
B.11 SpO ₂ Module Specifications.....	B-17

B.12 Air Compressor Specification.....	B-19
B.13 Backup Air Supply	B-19
C EMC	C-1
D Alarm Messages.....	D-1
D.1 Physiological Alarm Messages.....	D-1
D.1.1 Ventilator Parameters	D-1
D.1.2 CO ₂ Module.....	D-2
D.1.3 SpO ₂ Module	D-3
D.2 Technical Alarm Messages	D-4
D.2.1 Power Board.....	D-4
D.2.2 Main Control Board	D-5
D.2.3 Monitor Board.....	D-5
D.2.4 CO ₂ Module.....	D-9
D.2.5 SpO ₂ Module	D-10
D.2.6 Neo. Module.....	D-11
D.2.7 Auxiliary Pressure	D-11
E Factory Defaults	E-1
E.1 Ventilation Parameters	E-1
E.2 Setup	E-2
E.3 SystemSettings.....	E-3
E.4 Alarms.....	E-3
E.5 History	E-4
E.6 Special Functions.....	E-4
E.7 O ₂ Therapy.....	E-5
E.8 CO ₂ Module.....	E-6
E.9 SpO ₂ Module	E-6
E.10 Other	E-6
F Symbols and Abbreviations.....	F-1
F.1 Unit.....	F-1
F.2 Symbols.....	F-2
F.3 Abbreviations	F-2

1 Safety

1.1 Safety Information

DANGER

- Indicates an imminent hazard that, if not avoided, will result in death or serious injury.
-
-

WARNING

- Indicates a potential hazard or unsafe practice that, if not avoided, could result in death or serious injury.
-
-

CAUTION

- Indicates a potential hazard or unsafe practice that, if not avoided, could result in minor personal injury and/or product/property damage.
-
-

NOTE

- Provides application tips or other useful information to ensure that you get the most from your product.
-
-

1.1.1 DANGER

There are no dangers that refer to the product in general.

1.1.2 WARNING

WARNING

- **The ventilator must only be operated and used by authorized medical personnel well trained in the use of this product. Any unauthorized or untrained personnel should not perform any operations. It must be operated strictly following the Operator's Manual.**
 - **Before putting the system into operation, the operator must verify that the equipment, connecting cables and accessories are in correct working order and operating condition.**
 - **To avoid the risk of electric shock, this equipment must be connected to a properly installed power outlet with protective earth contacts only. If the installation does not provide for a protective earth conductor, disconnect it from the power line. In this case, lithium ion batteries should be used temporarily to supply power to the equipment.**
 - **Use external power source (AC power) before the batteries are depleted.**
 - **To avoid explosion hazard, do not use the equipment in the presence of flammable anesthetic agent, vapors or liquids. When O₂ is used, keep the ventilator away from any fire sources.**
 - **Do not place the ventilator adjacent to any barrier, which can prevent cold air from flowing, resulting in equipment overheating.**
 - **Do not open the case of the equipment, as you may suffer an electric shock. All servicing and future upgrades must be carried out by the personnel trained and authorized by us only.**
 - **Users should set alarm volume and alarm limits based on patients' actual condition. Do not rely exclusively on the audible alarm system for patient monitoring. Adjustment of alarm volume to a low level may result in a hazard to the patient. Always keep the patient under close surveillance.**
 - **The physiological parameters and alarm messages displayed on the screen of the equipment are for doctor's reference only and cannot be directly used as the basis for clinical treatment.**
 - **To dispose of the package material, observe the applicable waste control regulations. And keep the package material out of children's reach.**
 - **All staff should be aware that disassembling or cleaning some parts of the ventilator can cause risk of infection.**
-

 **WARNING**

- **Maintenance menu can only be accessed when the equipment is disconnected from the patient.**
- **Positive pressure ventilation may be accompanied by some side effects such as barotrauma, hypoventilation, hyperventilation, etc.**
- **Using high frequency electrosurgery equipment, defibrillators, or short-wave treatment equipment in the vicinity of the ventilator may interfere with its operation and pose a risk of patient injury.**
- **Do not use antistatic or conductive masks or patient tubing. They can cause burns if they are used near high frequency electrosurgery equipment.**
- **Do not use the ventilator in a hyperbaric chamber.**
- **If the equipment internal monitoring system malfunctions, an alternative plan must be available to ensure adequate level of monitoring. The operator of the ventilator must be responsible for patient's proper ventilation and safety under all circumstances.**
- **As required by the relevant rules and regulations, oxygen concentration should be monitored when the equipment is used on the patient. If your ventilator is not configured with such monitoring function or this function is turned off, use a monitor which complies with the requirements of ISO 80601-2-55 for oxygen concentration monitoring.**
- **All analog or digital products connected to this system must be certified to the specified IEC standards (such as IEC 60950 for data processing equipment and IEC 60601-1 for medical electrical equipment). All configurations shall comply with the valid version of IEC 60601-1. The personnel who are responsible for connecting the optional equipment to the I/O signal port shall be responsible for medical system configuration and system compliance with IEC 60601-1 as well.**
- **Do not touch the patient when connecting the peripheral equipment via the I/O signal ports or replacing the O₂ cell, to prevent patient leakage current from exceeding the requirements specified by the standard.**
- **This equipment is not suitable for use in an MRI environment.**
- **When the ventilator's gas supply input system fails or has faults, please contact us immediately for service by specified personnel.**
- **The ventilator shall not be used with helium or mixtures with Helium.**
- **Do not move the ventilator before removing the support arm from it, in order to avoid the ventilator getting tilted during the movement.**
- **The oxygen and air gas mixer of the ventilator is without grease and thus no de-grease process is needed. Do not use lubricants that contain oil or grease, and rubber hose assembly should not be contaminated with grease. Lubricants will burn or explode when exposed to high O₂ concentrations.**

 **WARNING**

- The maximum pressure of hose is 1.4MPa@21°C and please check whether gas supply pressure meets hose requirements before usage.
- Hose connectors adopt standardized gas terminal connector with gas nature. Different types of gas and gas with different pressures shall not be exchanged with each other.
- Hose may be aging quickly by long-term exposure to acidity, alkalinity or ultraviolet rays.
- Don't cascade two or more hose assemblies together.
- The ventilator arm could bear 1kg maximally and don't hang over 1kg goods.
- After the ventilator is installed or the main control board is replaced, the altitude must be reset. After resetting the altitude value, please perform flow calibration (factory).
- When disconnecting fast connectors, please operate by two hands to prevent potential injury caused by sudden pressure release.
- Do not block the air intake on the side of the ventilator.
- To prevent interrupted operation of the ventilator due to electromagnetic interference, avoid using the ventilator adjacent to or stack with other device. If adjacent or stacked use is necessary, verify the ventilator's normal operation in the configuration in which it will be used.
- To prevent possible personal injury and equipment damage, ensure that the ventilator is secured to the trolley or placed on the safe and smooth surface.
- To prevent possible equipment damage, avoid tipping over the ventilator when crossing thresholds.
- To prevent possible equipment damage, push the brake down when parking the ventilator.
- Avoid the use of polluted air. When the equipment uses air as gas source for ventilation, if the air is polluted, harmful substance may enter the patient tubing.
- To prevent patient injury caused by equipment malfunction, when the alarm [Technical Error**] occurs, remove the equipment immediately, record failure code, and contact the Customer Service Department.
- To prevent possible ventilator malfunction, do not spill liquid onto the ventilator.
- Backup air supply could cause gas to be heated. To reduce the temperature of gas inside the tubing and prevent patient injury accordingly, ensure that the length of patient tubing from the humidifier to Y piece is greater than 1.2m.
- The internal electrical power source is to be used temporarily if the integrity of the protective earth conductor or the protective grounding system in the installation is in doubt.

 **WARNING**

- **Nebulization or humidification can increase the resistance of breathing system filters, and that you need to monitor the filter frequently for increased resistance and blockage.**
 - **The ventilation accuracy can be affected by the gas added by use of a nebulizer.**
 - **The ventilator shall not be used with nitric oxide.**
 - **Check if the alarm limit settings are appropriate before taking measurement.**
 - **When operating the unit with the power supply unit, always connect the unit to an easily accessible outlet so that it can be unplugged quickly in the event of a malfunction.**
 - **No modification of this equipment is allowed.**
 - **Stop using the ventilator and contact us immediately when the buzzer sounds.**
 - **Please place cables of neonatal flow sensor correctly, to avoid patients from becoming entangled or unplanned extubation.**
 - **System leakage, such as leakage caused by an uncuffed endotracheal tube, may influence airflow readings, including airflow parameters, pressure, dead space, and CO₂ production.**
 - **When ventilator is connected to patient, do not remove or replace fuse, or perform any other maintenance tasks. Such tasks must be performed when the patient is not using the ventilator.**
 - **Please ensure that the AC power cord is disconnected before removing or replacing the fuse.**
 - **HAZARD can exist if different ALARM PRESETS are used for the same or similar equipment in any single area. Please read the manual and confirm the correct alarm pre-settings for the ventilator before using it.**
-
-

1.1.3 CAUTION

CAUTION

- The ventilator must be inspected and serviced regularly by trained service personnel.
 - To ensure patient safety, always prepare resuscitator for use.
 - Always have a special person attend and monitor the operation of the equipment once the ventilator is connected to the patient.
 - During the operation of the ventilator, do not disassemble the inspiration safety valve and expiration valve unless in standby status.
 - To ensure patient safety, use only parts and accessories specified in this manual.
 - At the end of its service life, the equipment, as well as its accessories, must be disposed of in compliance with the guidelines regulating the disposal of such products.
 - Magnetic and electrical fields are capable of interfering with the proper performance of the equipment. For this reason, ensure that all external devices operated in the vicinity of the equipment comply with the relevant EMC requirements. Mobile phone, X-ray equipment or MRI devices are a possible source of interference as they may emit higher levels of electromagnetic radiation.
 - This system operates correctly at the electrical interference levels identified in this manual. Higher levels can cause nuisance alarms that may stop mechanical ventilation. Pay attention to false alarms caused by high-intensity electrical fields.
 - Before connecting the equipment to the power line, check that the voltage and frequency ratings of the power line are the same as those indicated on the equipment's label or specified in this manual.
 - Always install or carry the equipment properly to avoid damage caused by dropping down, impact, strong vibration or other mechanical force.
 - Check whether the repetitive patient tubing is damaged or leaked before usage. If so, don't use such tubing.
 - To electrically isolate the ventilator circuits from all poles of the supply mains simultaneously, disconnect the mains plug.
 - To minimize the risk of fire, do not use supply hose assembly that is worn or contaminated with combustible materials like grease or oil.
 - It is the clinician's responsibility to ensure that all ventilator settings are appropriate.
 - To prevent possible patient injury, ensure the ventilator is set up for appropriate patient type with the appropriate patient tubing. Ensure that the System Check or
-

 **CAUTION**

tubing check is performed before each patient.















- **Perform Flow Sensor Calibration before the first use, or when the measured values have deviations.**
 - **To prevent possible patient injury, ensure the ventilation parameters are set up properly before ventilating the patient.**
 - **To ensure the accuracy of oxygen monitoring, replace an exhausted O₂ cell as soon as possible or use an external monitor that complies with ISO 80601-2-55.**
 - **A fan failure could result in oxygen enrichment inside the ventilator and a subsequent fire hazard.**
 - **To reduce the risk of explosion, do not force the chemical O₂ cell open or place it close to a source of heat.**
 - **When ventilating with a mask, avoid high airway pressures. High pressures may cause gastric distension.**
 - **Peak pressures exceeding 33 cmH₂O may increase the risk of gastric insufflation when the ventilation type is non-invasive. When ventilating with such pressures, consider using an invasive mode.**
 - **To reduce the risk of fire, use only tube systems approved for medical purposes and for use with oxygen between the oxygen source and ventilator.**
 - **To reduce the risk of fire, ensure adequate ventilation at the rear of the ventilator.**
 - **To reduce the risk of fire, switch off the oxygen source when the ventilator is not in a ventilating mode.**
 - **Avoid putting the ventilator in the storage environment of more than 50°C for a long time. Such environment may damage or shorten the battery lives of internal battery and O₂ cell.**
 - **Use the original packing materials to ship the ventilator.**
 - **To prevent fire hazard, use only specified fuses or fuses with the same type, rated voltage, and rated current as the existing fuses. When it is necessary to replace fuses, contact the Customer Service Department.**
 - **The ventilator is suitable for use within the PATIENT ENVIRONMENT.**
 - **Additional MULTIPLE SOCKET- OUTLET or extension cord shall not be connected to the system.**
 - **Before moving the ventilator, ensure that the casters and brakes can work properly, and the main unit is locked on the trolley.**
 - **Please use dry and clean medical compressed air and oxygen as gas supply. Water in gas supply can cause equipment malfunction.**
-

































1.1.4 NOTE



















NOTE



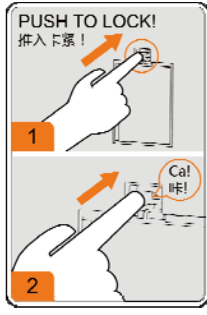
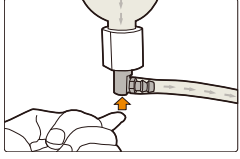

- Put the ventilator and its accessories in a location where you can easily see the screen and access the operating controls.
 - Keep this manual close to the equipment so that it can be obtained conveniently when needed.
 - The software was developed in compliance with IEC 62304. The possibility of hazards arising from software errors is minimized.
 - This manual describes all features and options. Your equipment may not have all of them.
 - When the oxygen supply is insufficient, the ventilator will automatically switch to air supply. When the air supply is insufficient, the ventilator will automatically switch to oxygen supply.
 - The ventilator is equipped with barometric pressure sensors, and has the function of barometric pressure compensation.
-

1.2 Equipment Symbols

	AUDIO PAUSED		ALARM OFF
	Recent Alarm		Clear alarm
	Alarm settings		O ₂ ↑key
	Nebulizer		Tools key
	Setup		Standby key
	Preventive maintenance		Screen Capture
	History		Backup Air Supply

	Freeze		Invasive Ventilation
	Inspiratory trigger icon		Non-Invasive Ventilation
	Adult (male)		Adult (female)
	Pediatric (male)		Pediatric (female)
	Neonate		Adjust screen brightness/volume to night mode
	Start O ₂ therapy timer		Adjust screen brightness/volume to day mode
	Stop O ₂ therapy timer		Reset O ₂ therapy timer
	Caution		Equipotentiality
	Fuse		Protective earth ground
	Battery LED		AC power
 RS-232	RS-232 connector		VGA output connector
	USB connector		Network connector
	Display connector		Nurse call connector
	Oxygen sensor connector		Pneumatic nebulizer connector
	Lock		Unlock
	Power switch		Neonatal flow sensor connector

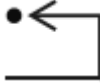
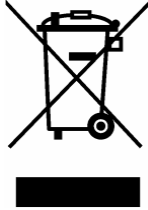
Paux1	Auxiliary pressure measurement connector 1	Paux2	Auxiliary pressure measurement connector 2
	Expiration connector		Inspiration connector
 280-650 kPa 41-94 psi V'max 180L/min	Oxygen supply connector	 280-650 kPa 41-94 psi V'max 180L/min	Air supply connector
	Date of manufacture		Manufacturer
	Serial number		European community representative
	Keep dry		Temperature limitation
	Humidity limitation		Atmospheric pressure limitation
	This way up		Fragile, handle with care
	Recyclable		Stacking limit by number
IP21	Degree of protection against harmful ingress of water		MR Unsafe - do not subject to magnetic resonance imaging (MRI)
	High Efficiency Particle Air (HEPA) installation instruction		Water trap indicator
	Refer to the operator's manual		Ventilator gas outlet

	Defibrillation-proof BF application part		DEFIBRILLATION- PROOF TYPE CF APPLIED PART
	Reset the paramagnetic oxygen sensor (NOTE: This operation can be performed only by the Customer Service Department or authorized personnel.)		
	<p>The following definition of the WEEE label applies to EU member states only.</p> <p>This symbol indicates that this product should not be treated as household waste. By ensuring that this product is disposed of correctly, you will help prevent bringing potential negative consequences to the environment and human health. For more detailed information with regard to returning and recycling this product, please consult the distributor from whom you purchased it.</p> <p>* For system products, this label may be attached to the main unit only.</p>		
	<p>The product bears CE mark indicating its conformity with the provisions of the Council Directive 93/42/EEC concerning medical devices and fulfills the essential requirements of Annex I of this directive.</p>		
	<p>Unified circulation mark indicates that products marked them passed all specified in the technical regulations of the Customs Union of the procedure for the assessment (confirmation) of conformity and complies with the requirements applicable to all the products technical regulations of the Customs Union.</p>		

FOR YOUR NOTES

2 The Basics

2.1 System Description

2.1.1 Intended Use

This product is intended to be used in intensive care situations within a professional healthcare facility, or during transport within a professional healthcare facility. This product is intended to provide ventilation assistance and breathing support for adult, paediatric and neonate patients. The product should be operated by properly-trained and authorized medical personnel. This equipment is not suitable for use in an MRI environment.

2.1.2 Contraindications

There are no absolute contraindications for this product. For some special diseases, however, some necessary treatments shall be taken for ventilator mechanical ventilation, or special ventilation modes shall be adopted to prevent possible patient injury.

2.1.3 Components

The ventilator consists of a main unit (including pneumatic circuit, electronic system, mechanical structure, display, CO₂ module, SpO₂ module), backup air supply, air compressor (model: C3), trolley, and support arm.

The ventilator is suitable for use within the PATIENT ENVIRONMENT. Connect the patient to the ventilator via the patient breathing circuit. The applied part of the ventilator is breathing masks.

2.2 Equipment Appearance

2.2.1 Front View

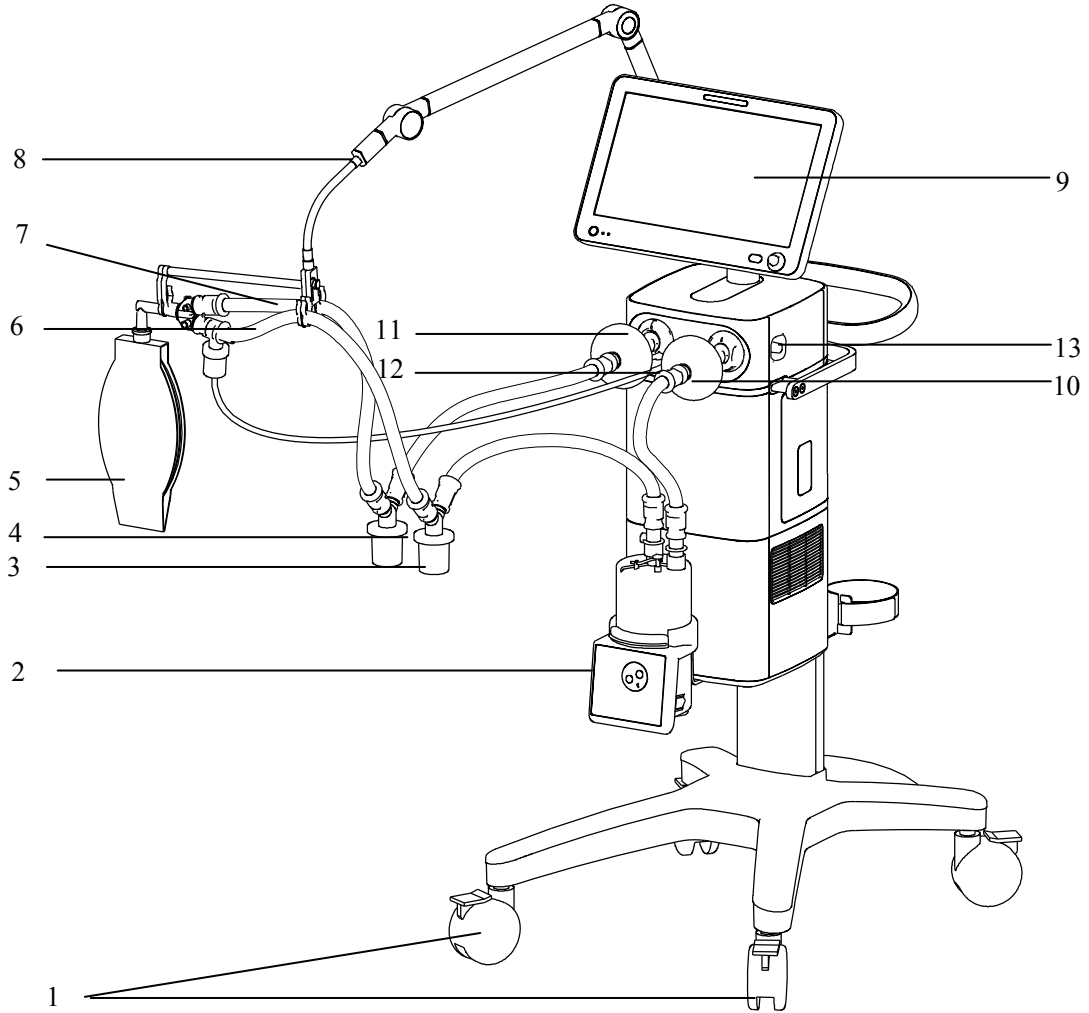

-
1. Caster and brake
The ventilator has four casters and all casters have brakes.
 2. Humidifier
 3. Inspiratory water trap
Collects condensed water in the inspiratory tube.
 4. Expiratory water trap
Collects condensed water in the expiratory tube.
 5. Test lung
 6. Inspiratory tube
 7. Expiratory tube
 8. Support arm
Supports and hangs the patient tubing.
 9. Display
 10. Inspiratory filter
 11. Expiratory filter
 12. Nebulizer connector
To connect pneumatic nebulizer.
 13. Leak test plug
For System Check or Flow Calibration.

2.2.2 Rear View

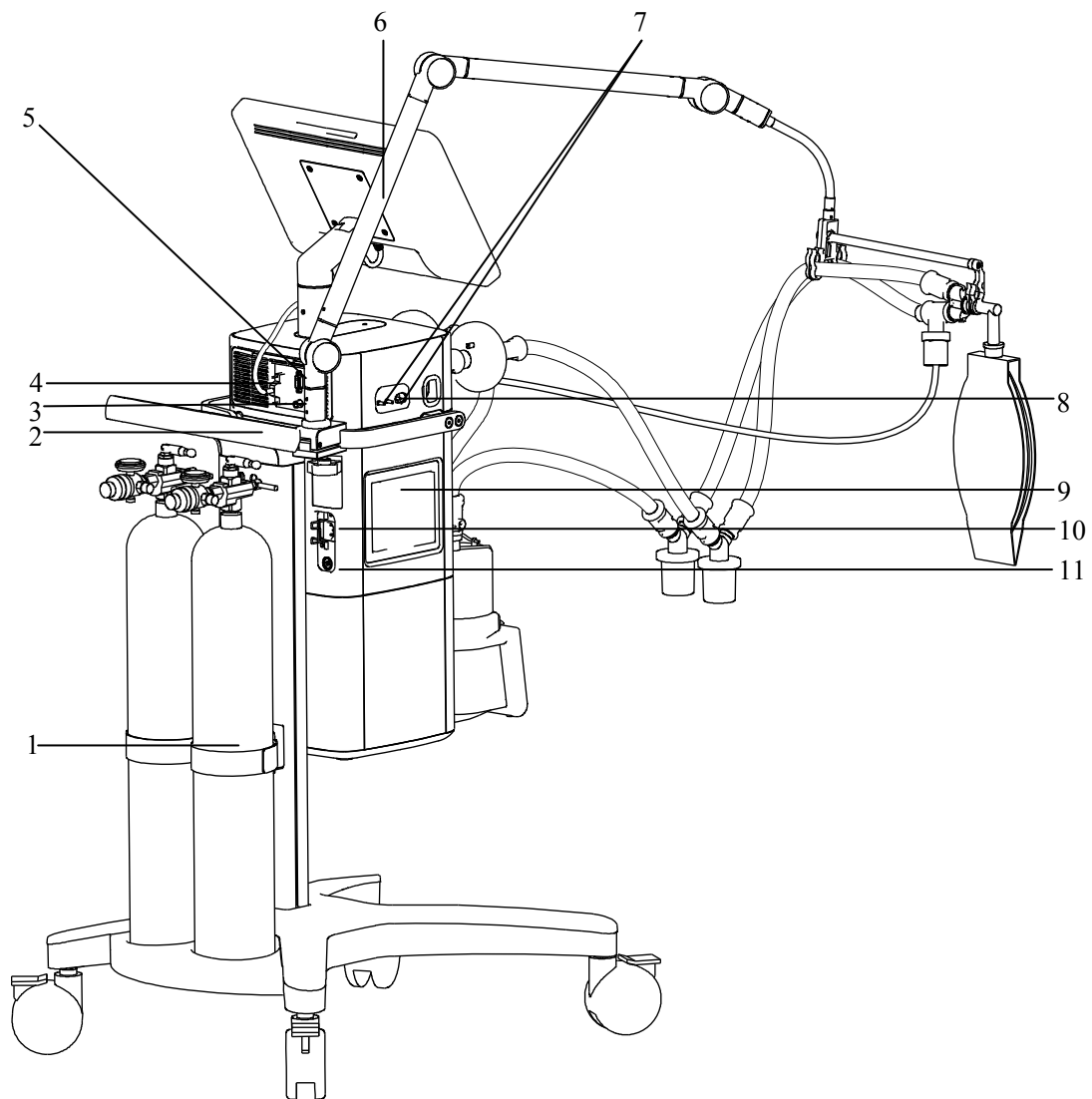

1. Cylinder retaining clip
For retaining the gas cylinder.
2. Trolley rear handle
3. Nurse call connector
Connects to the hospital's nurse call system and outputs nurse call signals when an alarm occurs.
4. Main unit and display connector
5. RS-232 connector
Connects to the external calibration device for calibrating pressure. An external medical device can be connected via this connector to communicate with the ventilator.

6. Display

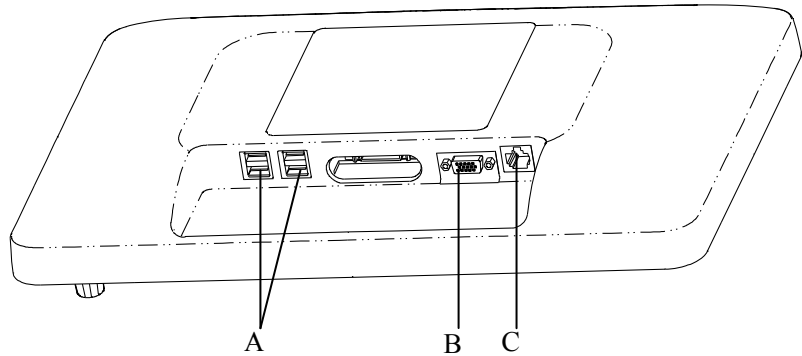

A. USB connector

Conducts ventilator software upgrade, configuration information and history data (such as patient data, alarm log) export, configuration transfer between machines of the same type via USB device. The device can also be connected to the electronic nebulizer via USB.

B. VGA connector

Outputs VGA video signals with the same contents to the primary display and connects to the external display (supporting display with resolution of 1920*1080).

C. Network connector

A connector which supports connection with a PC to perform software upgrade and connection with external medical and information device.

7. Auxiliary pressure measurement connector

Provides auxiliary pressure monitoring functionality.

8. Neonatal flow sensor connector

Connects neonatal flow sensor.

9. Module slot

Inserts and identifies CO₂ module and SpO₂ module mentioned in this manual.

10. AC power receptacle

11. Equipotential stud / lug

2.2.3 Air Compressor

The air compressor has two types of configurations: standby and non-standby.

In case of standby configuration, the compressor starts to deliver compressed air to the ventilator or anesthesia machine automatically if the hospital central pipeline gas supply stops supplying gas. The compressor stops delivering compressed air automatically when the central pipeline gas supply returns to normal.

In case of non-standby configuration, central pipeline gas supply inlet is not available and only compressed air outlet is available.

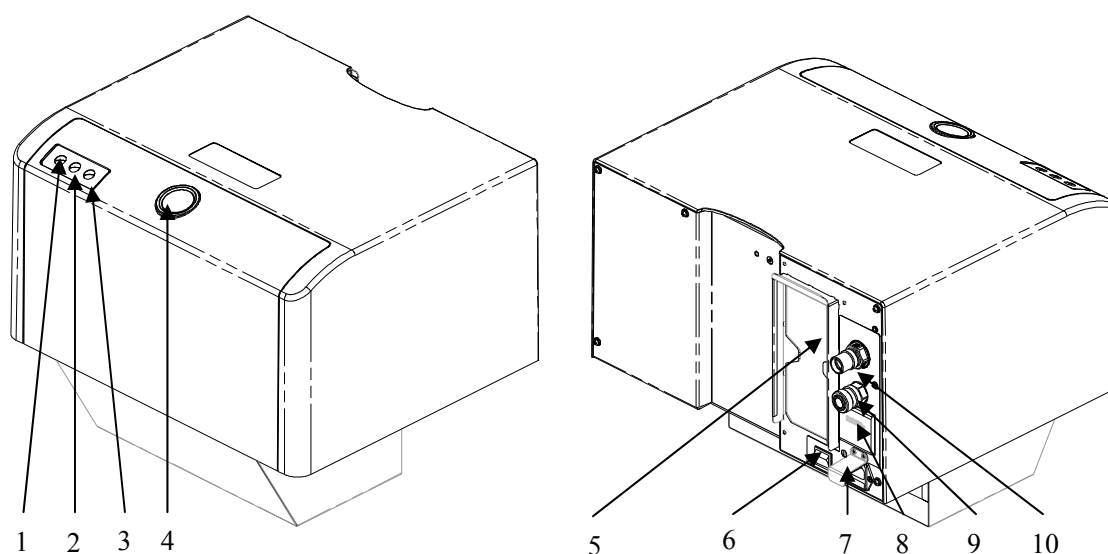

1. Power indicator

The power indicator is lit when the compressor is connected to power supply and the power switch is turned on.

2. Status indicator (standby configuration)

The status indicator is lit when the central pipeline gas supply is applied.

3. Warning indicator

The warning indicator is lit when some failures occur to the compressor (e.g. internal temperature abnormally high, semiconductor refrigeration failure, solenoid valve failure, or fan failure). In this case, the compressor may shut off at any time and stop delivering gas.

4. Pressure gauge

The pressure gauge indicates the air pressure at the compressed air outlet.

5. Air intake vent (with dust filter)

6. Power switch

Turn on or turn off the air compressor.

7. Mains power inlet (with fixing pressure plate)

8. Hourmeter

The hourmeter indicates the accumulated running time of the compressor (not including the accumulated running time when the central pipeline gas supply is applied).

9. Compressed air outlet

10. Central pipeline gas supply inlet (standby configuration)

NOTE

-
- **Burn-in is required for the compressor before delivery. The reading indicated by the compressor hourmeter shall be less than 150 hours at the time of delivery.**
-

FOR YOUR NOTES

3 Installations and Connections

WARNING

- Do not use antistatic or conductive masks or patient tubing. They can cause burns if they are used near high frequency electrosurgery equipment.
 - To ensure optimum performance of the ventilator, re-do System Check each time when accessories or components like patient tubing, humidifier, and filter are replaced.
 - Adding accessories or other components to the breathing system of the ventilator can increase system inspiratory and expiratory resistance.
-

3.1 Connect the Power Supply

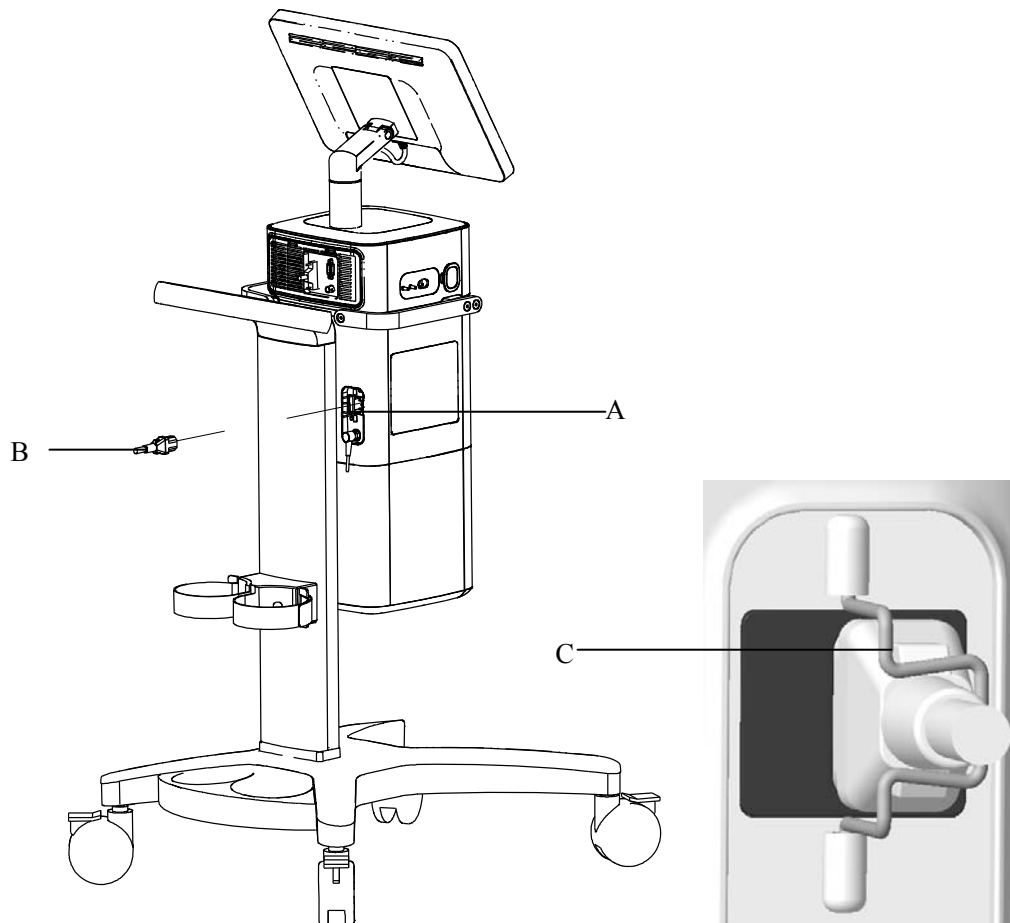

A. AC power receptacle B. AC power cord C. Anti-unplugging hook of power

-
1. Turn the anti-unplugging hook of power to the right-hand side.
 2. Insert the AC power cord into the AC power receptacle.
 3. Put back anti-unplugging hook of power to clamp the power cord in place.

3.2 Connect the Pipeline Supply

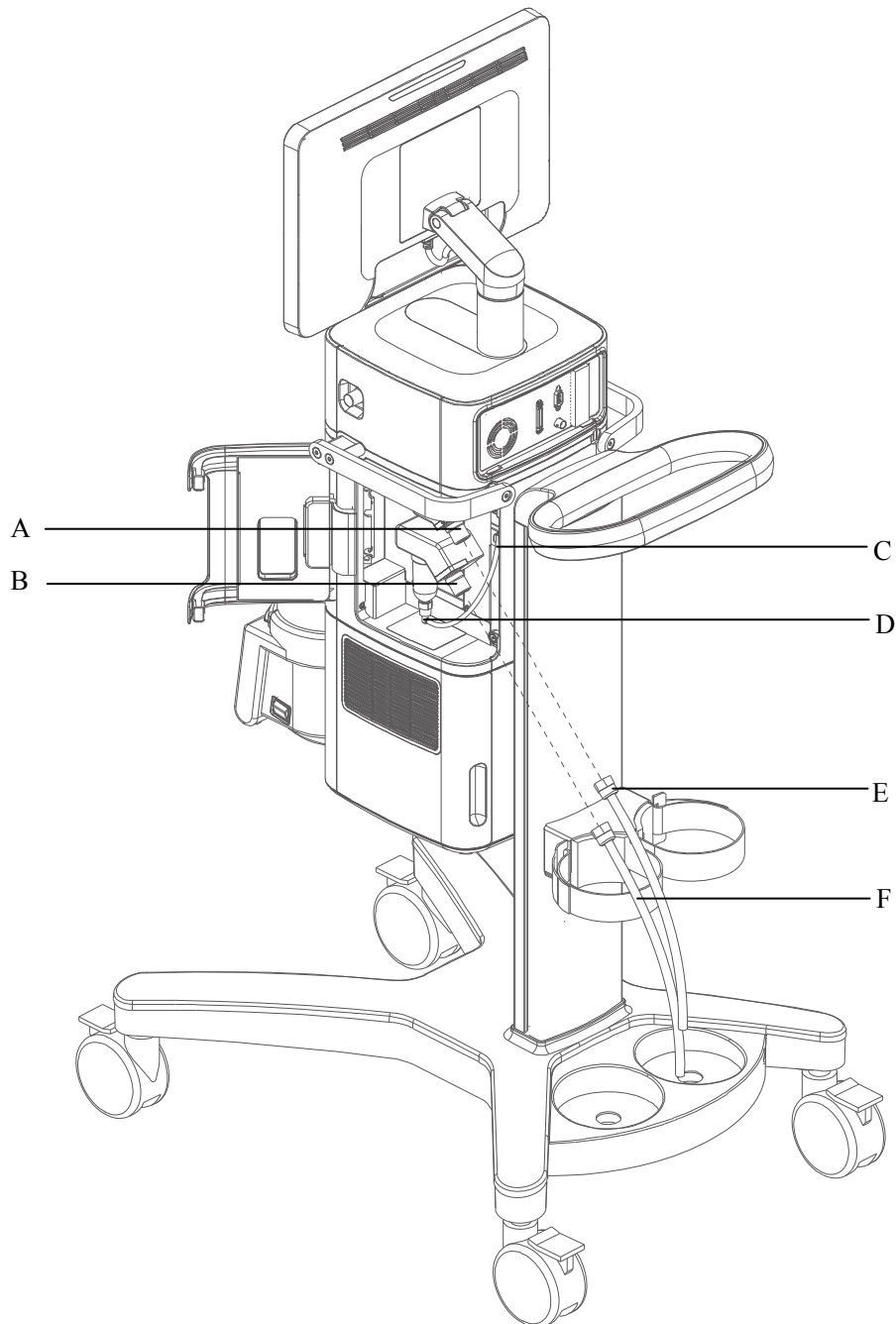

- | | |
|---|---------------------|
| A. Oxygen supply inlet | B. Air supply inlet |
| C. Drainage tube and slot | |
| D. Pushrod of water trap and drainage valve at air supply inlet | |
| E. O ₂ supply hose | F. Air supply hose |

This ventilator provides O₂ and air supply connectors. Supply hoses are marked in different colors. The connector of each hose should not be exchanged with each other. Gas supply hoses and the ventilator are connected as follows.

1. Check whether the sealing ring on the gas supply hose connection is in good condition before connecting the gas supply hose. If the sealing ring is damaged, do not use the hose. Replace the sealing ring to prevent leakage.
2. Align the hose connector with and insert it into the inlet of the O₂ supply or air supply on the back of the ventilator.
3. Ensure that the gas supply hose is properly connected to the gas supply inlet. Tighten the hose nut.

During use, the operator can check the water volume in the water trap through the transparent observation window on the side door of the machine. If the water level is close to the filter element, please take out the drain pipe from the slot and press the drainage valve pushrod of water collection cup up to drain the water. Please place a container under the water trap to catch the water, so that the water will not splash on the machine. Pushrod of drainage valve will automatically re-place to its original position after drainage and then re-place the drainage tube to the slot. Please contact your service personnel if any crack and leakage is found on water trap.

NOTE

-
- **When draining the water, please use a container to catch the water, so that the water will not splash on the machine.**
 - **If drainage in the ventilation status, please prevent water splash and use a container to prevent water from directly spraying to the battery bottom.**
-

WARNING

-
- **Inspect the oxygen supply connector carefully and ensure that there is no leakage. If there is significant gas leakage, oxygen concentration in the surrounding environment will exceed normal oxygen concentration in the atmosphere, resulting in a potentially dangerous oxygen-enriched environment.**
 - **Place the supply hose carefully, avoiding exposure to the environment in which possible damage to the supply hose is easily caused by cut or heating.**
 - **The compressed gas must be dry, and free from dust and oil. Gas pressure must be 280 kPa to 650 kPa. Otherwise, the correct functioning of the device is not assured.**
-

3.3 Install the Gas Cylinder

CAUTION

- Ensure that the gas cylinder is equipped with pressure-reducing valve.
-

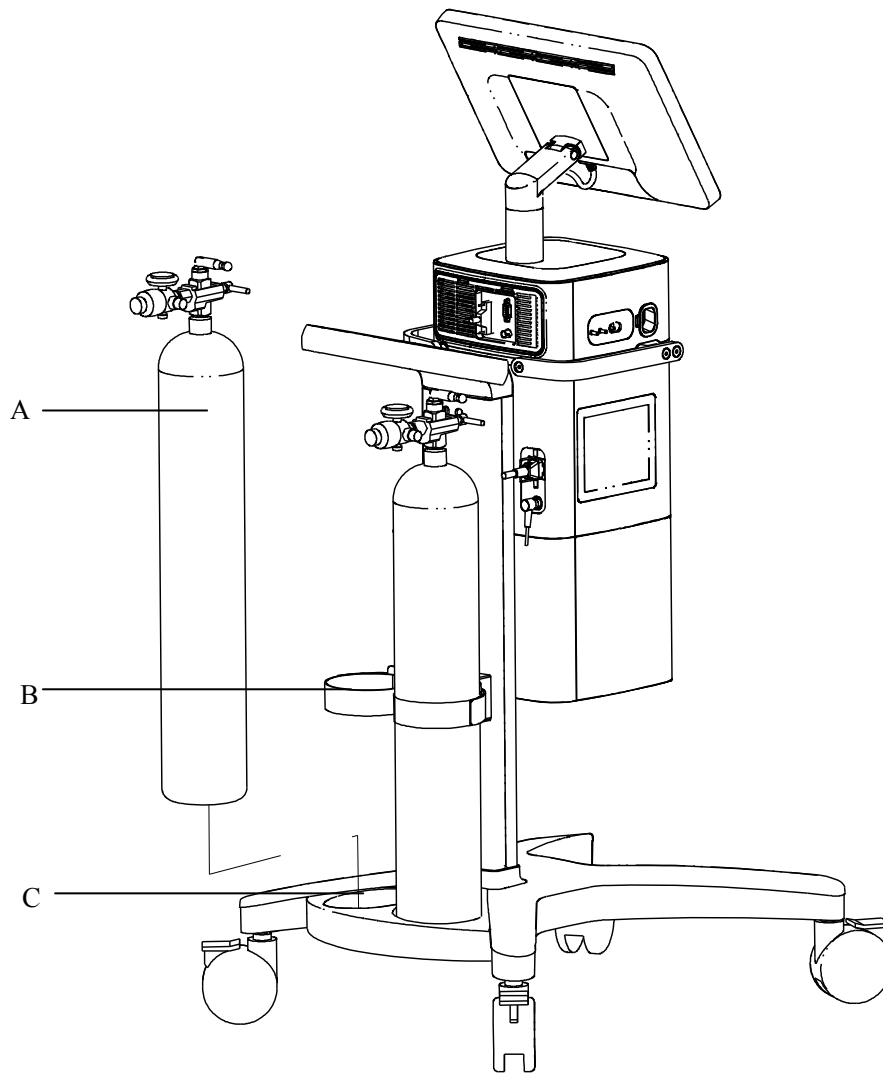

A. Gas cylinder

B. Cylinder fixing buckle

C. Trolley base

1. Place the gas cylinder onto the trolley base.
2. Fix the gas cylinder via cylinder fixing buckle.

3.4 Install the Support Arm

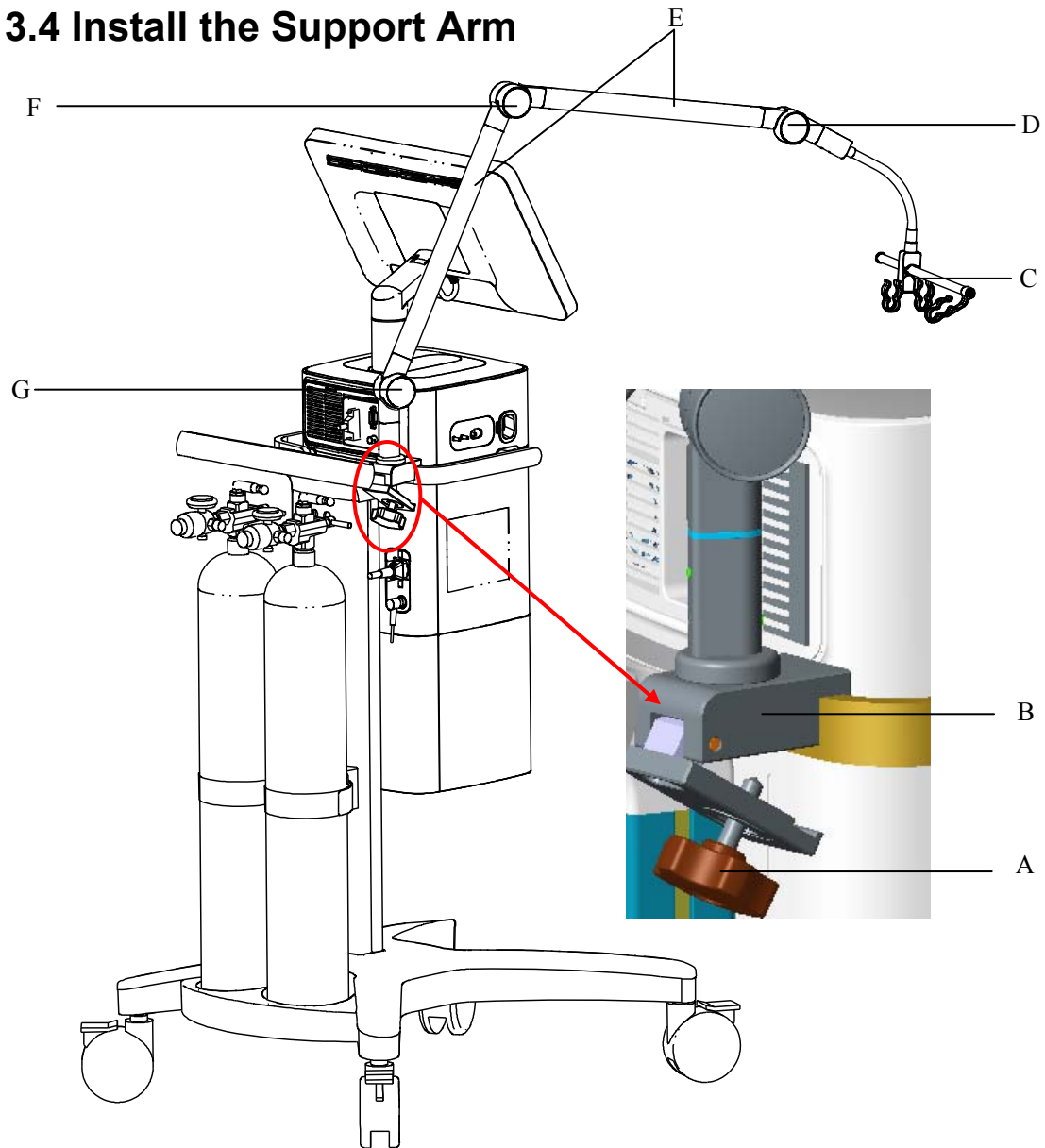



- A. Fixing block knob
- B. Fixing block
- C. Tube hook
- D. Support arm joint
- E. Support bar
- F. Support arm joint
- G. Support arm joint

-
1. Loosen the fixing block knob. Place the fixing block onto the handle at the rear of the ventilator.
 2. Tighten the fixing block knob.

 **WARNING**

- **To prevent possible patient injury due to accidental extubation, check the support arm joints and the connection security as necessary.**
-
-

3. Adjust the support arm.
 - Support arm joint F or G: to adjust the upward-bending angle of the support arm, only lift up the support bar to the desired position without the need to push the blue unlocking key . To adjust the downward-bending angle of the support arm, lift up the support bar, and then push and hold the blue key  on support arm joint with one hand, and hold the support bar and press it downward with the other hand. Release the blue unlocking key  after adjusting the support bar to the desired position. Support arm joint F or G can be adjusted for up to 130°.
 - Support arm joint D: swivel upward or downward to the desired position.
 - Hold the bottom of support arm or the support bar beside support arm joint G and swivel it to the left, or to the right, with force to rotate the support arm to the desired position.
4. Place the patient tubing onto the tube hook.

NOTE

- Operate support arm joint F or G with both hands as shown below. Operating with a single hand will bring some risks.



- The maximum weight of the support arm is 1 kg.
 - Please install the support arm according to the instruction on the handle of the ventilator.
-

3.5 Install the Patient Tubing

WARNING

- To minimize the risk of bacterial contamination or physical damage, remove and install the bacterial filter with care.
 - To prevent patient or ventilator contamination, always use a bacteria filter between the ventilator and the patient inspiratory limb.
-
-

CAUTION

- The use of an expiratory filter may lead to a significant increase in expiratory resistance. Excessive expiratory resistance may compromise ventilation and increase patient's work of breathing and intrinsic PEEP.
 - The patient tubing shall comply with the requirements of ISO 5367.
 - The bacteria filters shall comply with the requirements of ISO 23328-1 and ISO 23328-2.
 - The Heat & Moisture Exchange (HME) shall comply with the requirements of ISO 9360-1 and ISO 9360-2.
-

3.5.1 Install Adult/Pediatric Tubing

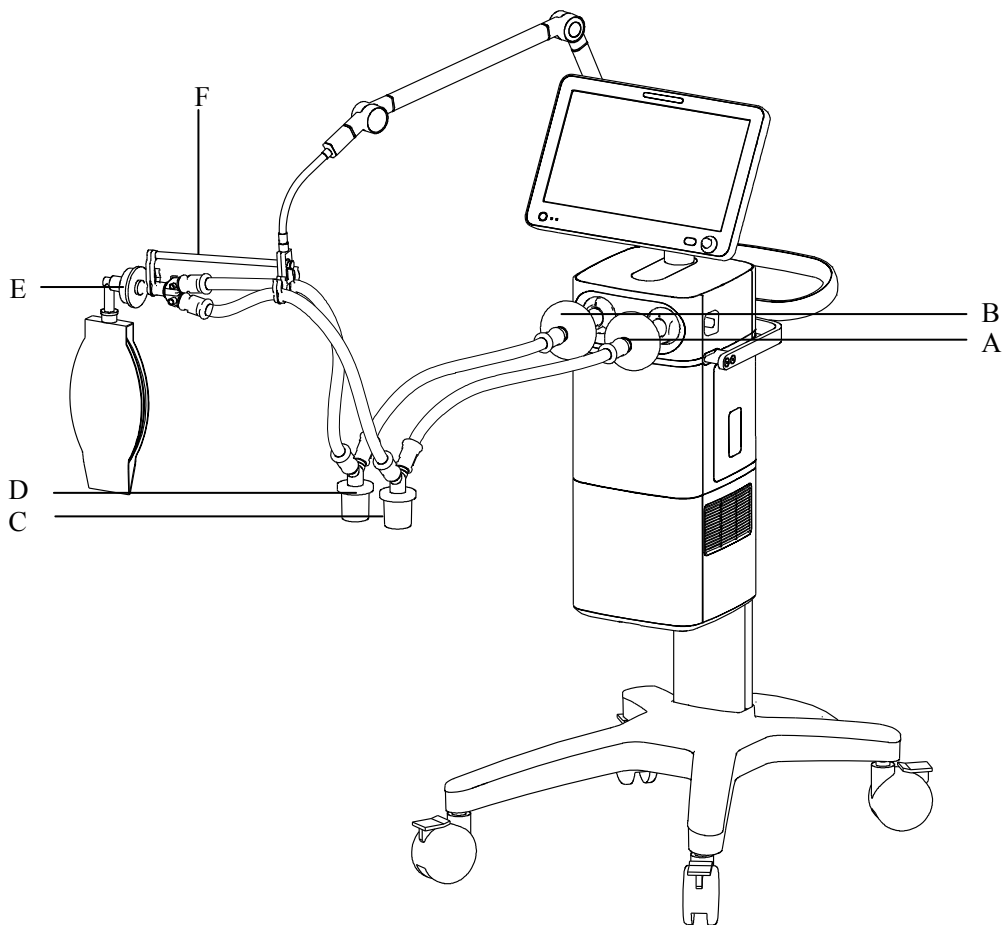

- | | |
|---------------------------|--------------------------|
| A. Inspiratory filter | B. Expiratory filter |
| C. Inspiratory water trap | D. Expiratory water trap |
| E. HME | F. Support arm hook |

1. Mount the filters onto the inspiratory and expiratory ports.
2. Connect the inspiratory filter to the water trap via the tubing. Then connect the water trap to the Y piece via the tubing.
3. Connect the expiratory filter to the water trap via the tubing. Then connect the water trap to the Y piece via the tubing.
4. Connect the patient side of the Y piece to the HME and then connect the HME to the patient.
5. Place the patient tubing onto the support arm hook.

3.5.2 Install Neonate Tubing

The use of a F&P850 humidifier is recommended when installing neonate tubing.

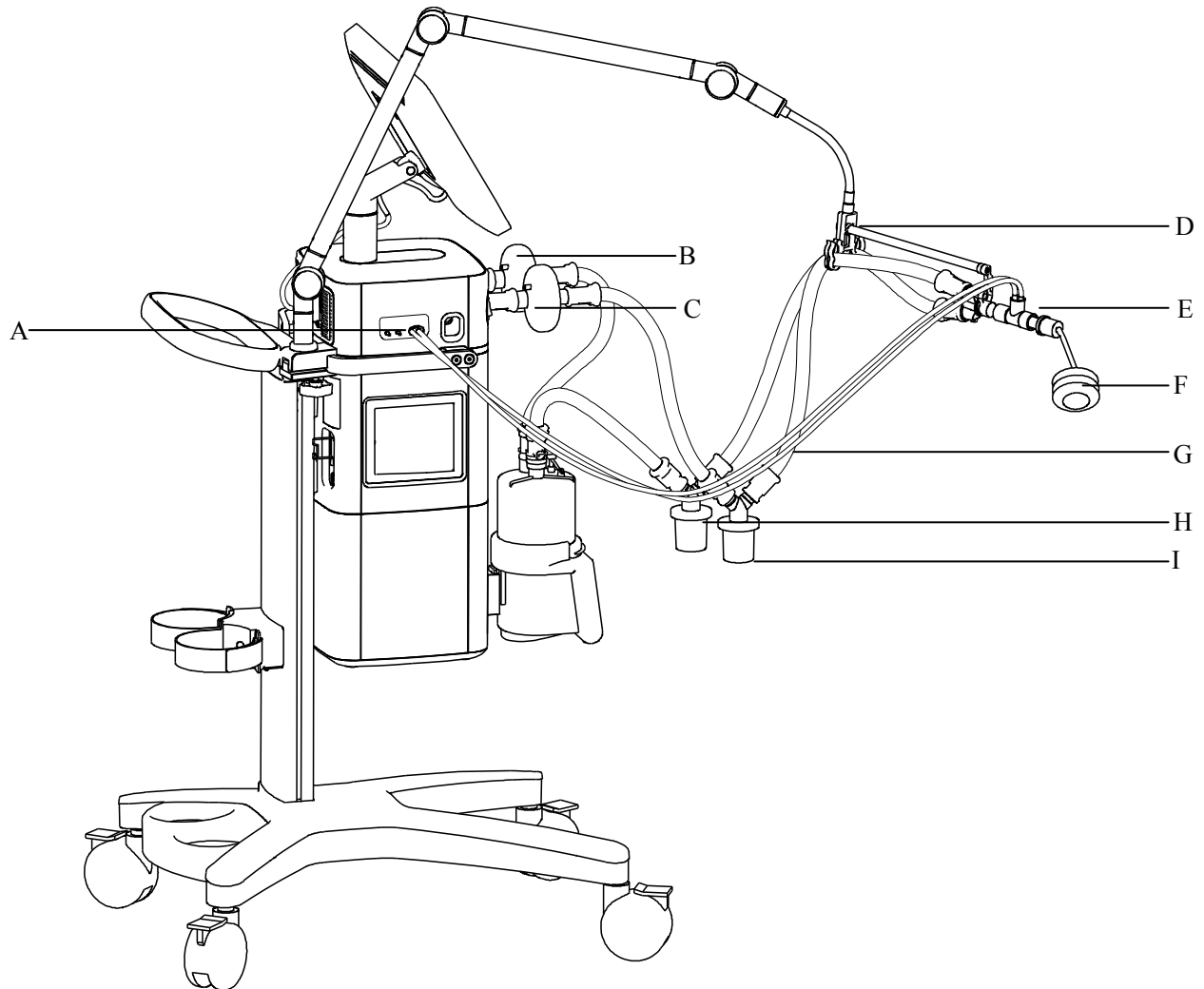

- | | |
|--|---------------------------|
| A. Neonatal flow sensor tubing connector | B. Inspiratory filter |
| C. Expiratory filter | D. Support arm hook |
| E. Neonatal flow sensor | F. Neonatal test lung |
| G. Neonatal flow sensor tubing | H. Inspiratory water trap |
| I. Expiratory water trap | |

-
1. Mount the filters onto the inspiratory and expiratory ports.
 2. Connect the inspiratory filter to the humidifier inlet via the tube.
 3. Connect the humidifier outlet to the water trap via the tubing. Then connect the water trap to the Y piece via the tubing.
 4. Connect the expiratory filter to the water trap via the tubing. Then connect the water trap to the Y piece via the tubing.
 4. Connect the neonatal flow sensor tubing to the neonatal flow sensor tubing connector on the ventilator.
 5. Connect the small end of the neonatal flow sensor to the Y piece, and the large end to the neonatal test lung. As shown in the figure below:

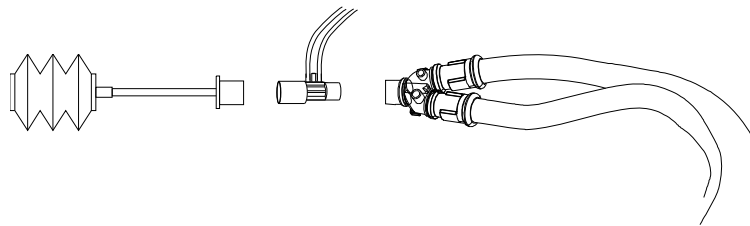

⚠ WARNING

- **Please keep the sensor tubing upright during installation and use of the neonatal flow sensor.**

-
6. Place the patient tubing onto the support arm hook.

3.6 Install the Humidifier

WARNING

- To prevent possible patient injury and equipment damage, do not turn on the humidifier until the gas flow has started and is regulated.
 - To prevent possible patient injury and equipment damage, ensure the humidifier is set to appropriate temperature and humidity.
-
-

NOTE

- The humidifier shall comply with the requirements of ISO 8185. The humidifier assembly and its installation steps described in this section are only for reference.
-
-

3.6.1 Install the Humidifier onto the Ventilator

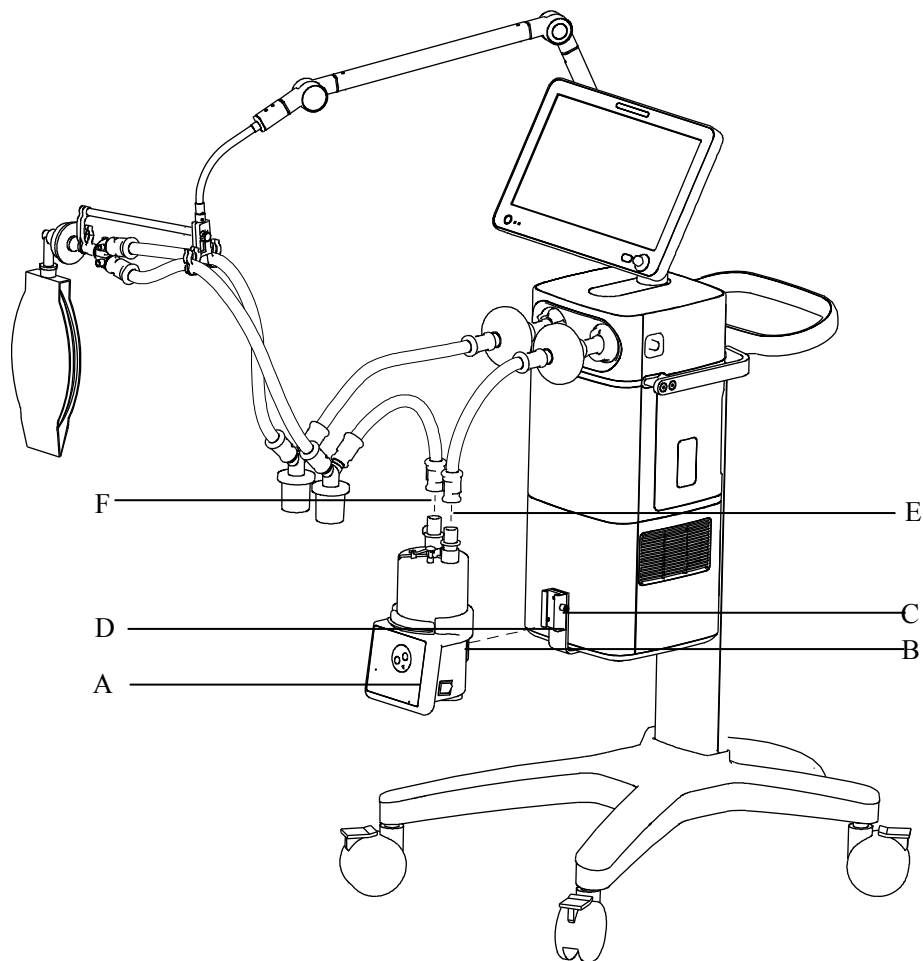

- | | | |
|---------------|------------------------------|----------------------------|
| A. Humidifier | B. Humidifier mounting plate | C. Humidifier bracket slot |
| D. Screw | E. Humidifier inlet | F. Humidifier outlet |

-
1. Align the humidifier mounting plate and the slot, and slide the humidifier in.
 2. Tighten the screw.
 3. Mount the filters onto the inspiratory and expiratory ports.
 4. Connect the inspiratory filter to the humidifier inlet via the tube.
 5. Connect the humidifier outlet to the water trap via the tubing. Then connect the water trap to the Y piece via the tubing.
 6. Connect the expiratory filter to the water trap via the tubing. Then connect the water trap to the Y piece via the tubing.
 7. Place the patient tubing onto the support arm hook.

The range of the ventilator breathing system (VBS):

Inspiratory and expiratory gas pathway resistance: 0 to 6 cmH₂O/ (L/s) at 60 L/min

VBS compliance: 0 to 5 ml/cmH₂O.

3.6.2 Install the Humidifier onto the Pendant

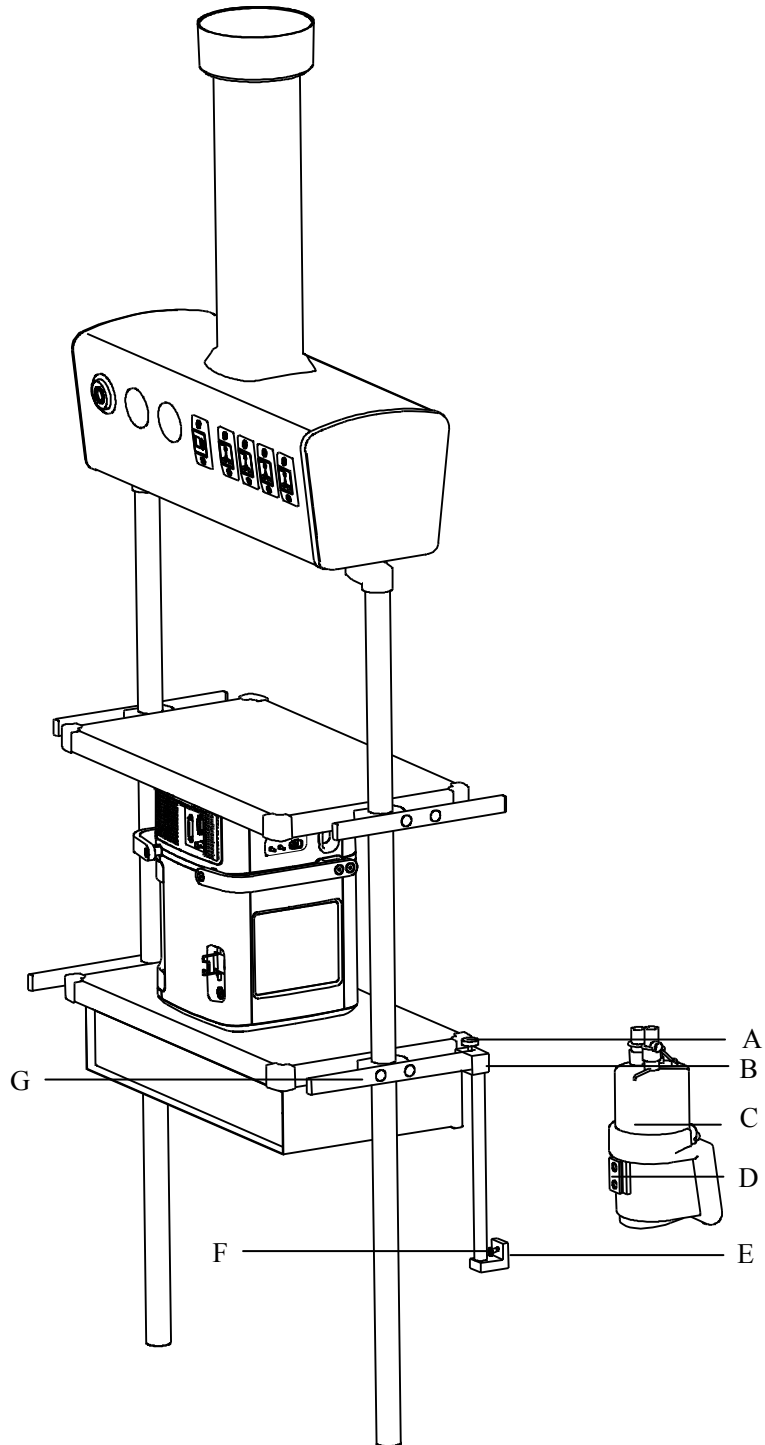

- | | | |
|------------------------------|----------------------------|-----------------|
| A. Humidifier | B. Fixing block knob | C. Fixing block |
| D. Humidifier mounting plate | E. Humidifier bracket slot | F. Screw |
| G. Beam | | |

-
1. Loosen the fixing block knob. Place the fixing block onto the pendant beam.
 2. Tighten the fixing block knob.
 3. Align the humidifier mounting plate and the slot, and slide the humidifier in.
 4. Tighten the screw.
 5. Install the patient tubing. For detailed connection method, refer to **3.6.I** steps 3 through 7.

 **WARNING**

- **Before installing the humidifier, ensure that the humidifier connector shall be lower than the ventilator's breathing connectors and the patient.**
-

3.7 Install the Nebulizer

NOTE

- **Install the specified nebulizer. The nebulizer assembly and its installation steps described in this section are only for reference. Refer to the nebulizer accompanying directions for use to install and use the nebulizer.**
 - **To prevent the expiration valve from sticking due to nebulized medications, use only medications approved for nebulization, and regularly check and clean or replace the expiration valve membrane.**
 - **Do not use an expiratory filter or HME in the patient's breathing circuit during nebulization. Nebulization can cause an expiratory side filter to clog, substantially increasing flow resistance and impairing ventilation.**
 - **Connect the nebulizer to the inspiratory limb. Connecting the nebulizer between the patient connector and the endotracheal tube increases dead space ventilation.**
-

3.7.1 Install Pneumatic Nebulizer

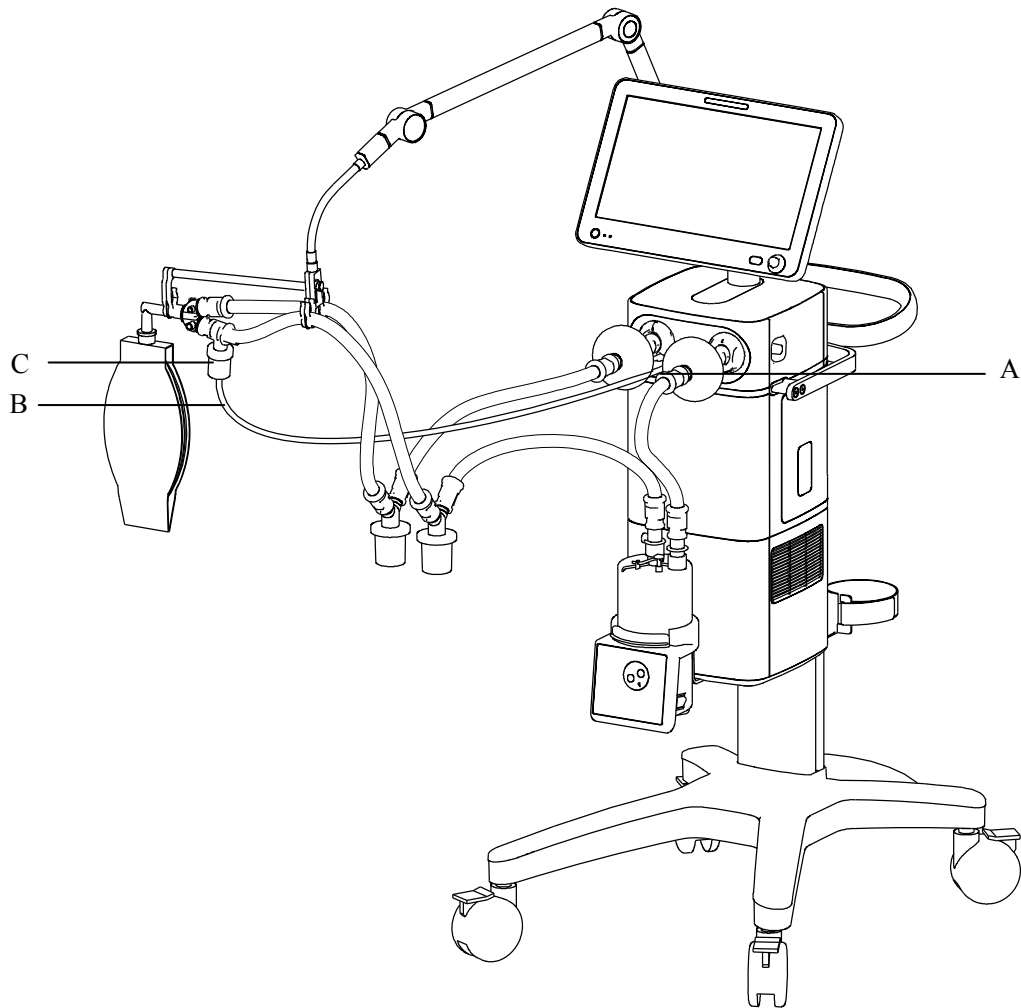

A. Nebulizer connector

B. Nebulizer tube

C. Nebulizer

1. Connect one end of the nebulizer tube to the nebulizer connector and the other end to the nebulizer.
2. Install the nebulizer in the inspiratory limb via the tube.

3.7.2 Install Electronic Nebulizer

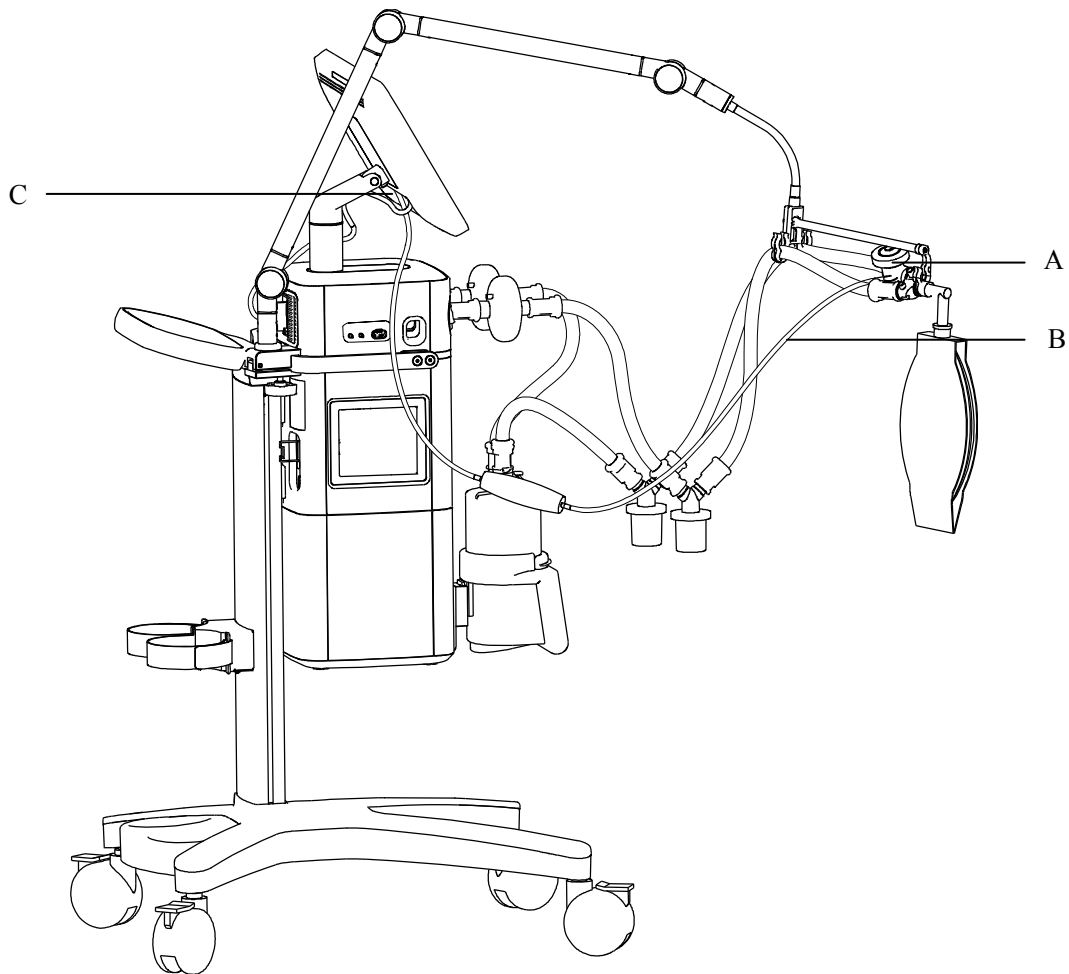

A. Nebulizer B. USB controller C. USB connector

1. Insert the USB connector of USB controller into the USB port below the display.
2. Connect the nebulizer with the patient tube. Refer to the nebulizer accompanying operator's manual for the details.

WARNING

- **Always maintain the nebulizer in a vertical orientation while in the patient circuit. This orientation helps prevent patient secretions and condensate from contaminating the aerosol generator of the nebulizer and ensures proper nebulization.**
 - **Refer to the nebulizer accompanying operator's manual to install and use the nebulizer.**
-

3.8 Install the Oxygen Sensor

This ventilator could be equipped with O₂ Cell or Paramagnetic O₂ Sensor. O₂ Cell is a consumable product and the service life is around 1 year and thus needs to be replaced periodically. O₂ Cell need to be calibrated regularly. Please refer to **13.2 Maintenance Schedule** for calibration cycle. The Paramagnetic O₂ Sensor could be used for a long term and no replacement is needed.

3.8.1 O₂ Cell

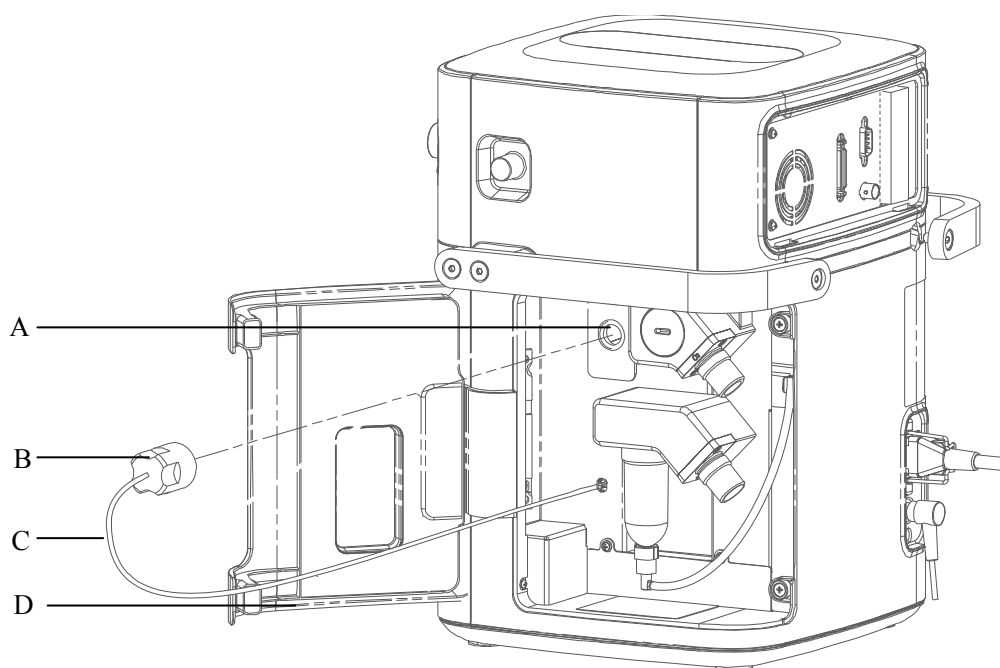

- | | |
|--|-------------------------------|
| A. Fixing seat | B. O ₂ Cell |
| C. O ₂ Cell connector cable | D. Main unit maintenance door |

1. Rotate the O₂ Cell clockwise to install it.
2. Connect the O₂ Cell connection cable.
3. Close the main unit maintenance door.

CAUTION

- To reduce the risk of explosion, do not burn the O₂ cell or force the cell open.
-

NOTE

- **If ICU work normally, the service life of O₂ Cell is one year. The service life of O₂ Cell is an approximate specification only. The actual cell life depends on operating environment. Operation at higher temperatures or higher O₂% shortens the life.**
-

3.8.2 Paramagnetic O₂ Sensor

If the paramagnetic O₂ sensor configuration is selected, its installation has been completed before the ventilator was dispatched from the factory.

WARNING

- **Under the normal usage, the ventilator equipped with paramagnetic O₂ sensor meets the requirements of ISO 80601-2-12 on shock and vibration test conditions for mobile ventilators and also complies with ISO80601-2-55 requirements of shock and vibration test conditions for special-purpose gas monitors during unexpected transfer. Shock and vibration beyond the standard will damage Paramagnetic O₂ Sensor and please place the ventilator into the package provided by the manufacturer when transferring the ventilator.**
-

3.9 Install Module

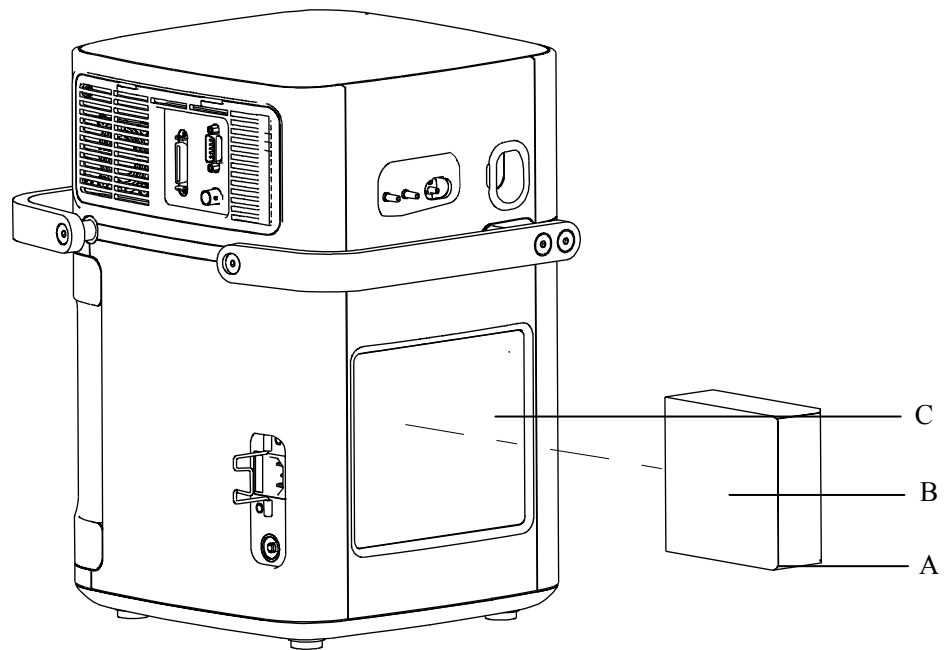

A. Latch at the bottom of the module B. Module C. Module slot

This equipment supports hot replacement of all modules. That is, you can plug in or unplug a module without needing to shut down the machine.

- Plug in module: align the module to the corresponding slot and push it in until the latch at the bottom of the module clicks into place. After plugging in the module, please confirm whether the indicator light on the module is on or off. If it is not switched on, please re-insert the module.
- Unplug module: pull the module outwards after lifting the latch upwards, and remove the module.

FOR YOUR NOTES

4 User Interface

4.1 Display Controls

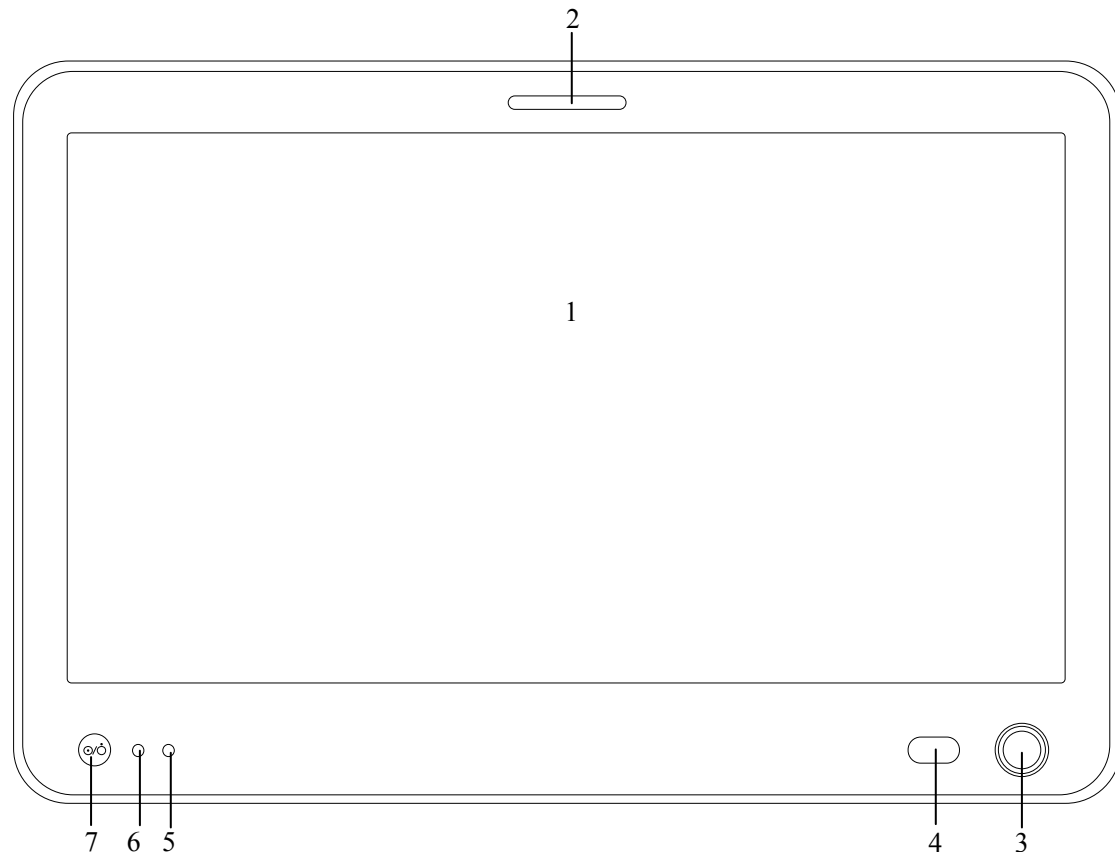

The control unit is characterized by a small number of operating elements. Its main elements are:

1. Display (touch screen)

The display shows the software screen of the ventilator system. You can select and change settings by touching the screen.

2. Alarm indicator light

The alarm indicator light indicates the priority of an active alarm by flashing different colors at different frequencies.

3. Control knob

Press the control knob to select menu items or confirm settings. Rotate clockwise or counterclockwise to scroll through menu items or change settings.

4. Alarm **AUDIO PAUSED** key

Press to initiate the **AUDIO PAUSED** for 120 seconds, so that audible alarm tones of the active alarms are switched off. If **AUDIO PAUSED** exceeds 120 seconds, the **AUDIO PAUSED** status terminates automatically and audible alarm tones are restored.

If a new alarm is triggered under **AUDIO PAUSED** status, the **AUDIO PAUSED** status terminates automatically and audible alarm tones are restored. Under **AUDIO PAUSED** status, press this key a second time to terminate **AUDIO PAUSED** status.

5. Battery indicator light

- Lit: indicates that the battery is being charged or is already fully charged, and the ventilator is operating on external power supply.
- Flash: when the ventilator is operating on battery power.
- Not lit: indicates that the ventilator is not connected to an external power supply, or that the ventilator does not have a battery installed, or that there is a fault with the battery.

6. External power indicator light

- Lit: when the ventilator is connected to an external power supply.
- Not lit: when the ventilator is not connected to an external power supply.

7. Power switch (with indicator light)

Press to power on/off the system. Switch is lit when the system powers on the ventilator and not lit when the system powers off the ventilator.

The ventilator display shows ventilation parameters, pressure/flow/volume waveforms and spirometry loops, etc.

The following is an example of Waveforms screen. Display screen may vary subject to the configurations.

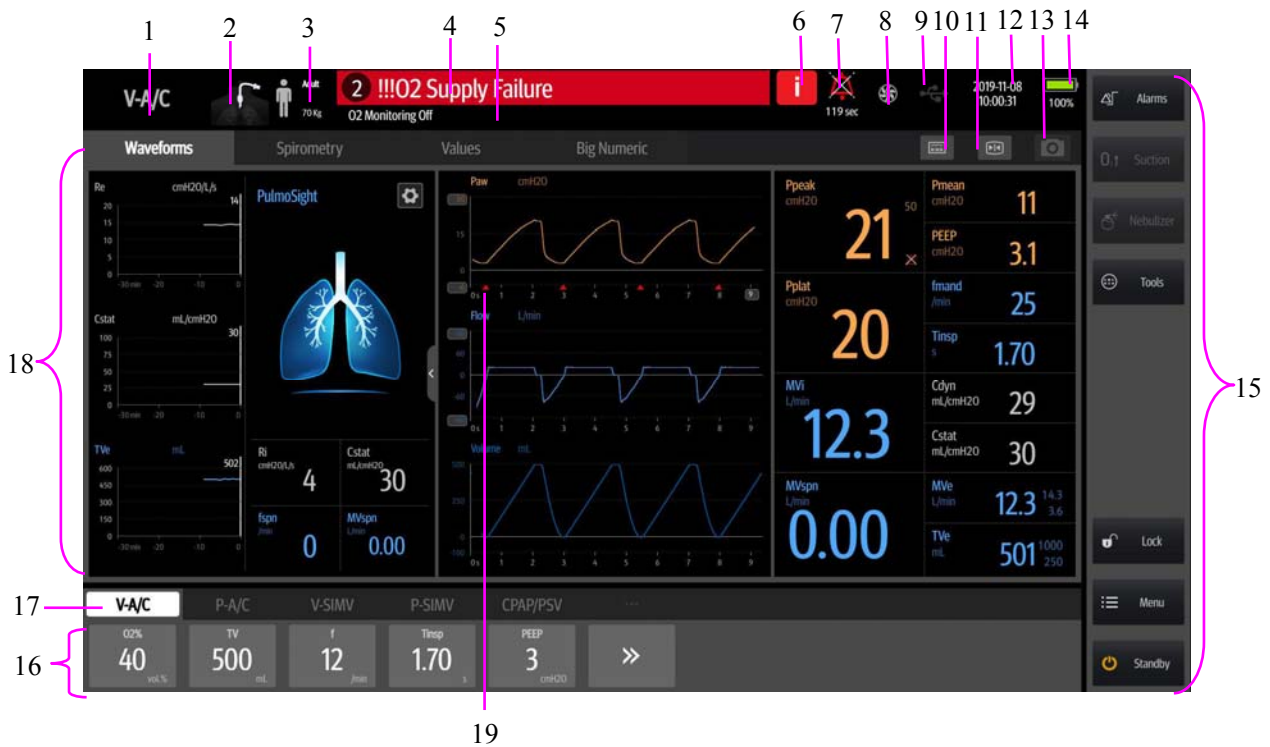



1. Ventilation mode field

Displays Standby or active ventilation mode and ventilation assist indication.

2. Ventilation type field

Displays Non-invasive or Invasive ventilation type:

- ◆ Displays the icon  for Non-invasive mask and NIV word when the ventilation type is Non-invasive.
- ◆ Displays the tube icon  when the ventilation type is invasive and the ATRC function is switched off.
- ◆ Displays the tube icon  and tube diameter when the ventilation type is invasive and the ATRC function is switched on.

3. Patient type / Inspiratory trigger icon field

Indicates current patient type. The icon for Inspiratory trigger is , which is displayed for 1 s.

4. Alarm message field

Displays the active alarm messages. When there are multiple alarm messages, the number of alarms is displayed. In this case, by clicking the alarm message field, you can view current alarm messages, alarm subordination (alarm chain), alarm occurrence time and alarm level, as well as suggested measures after the occurrence of an alarm, or alarm help information in the opened interface.

5. Prompt message field

Displays the active prompt messages.

6. Inactivated alarm indicating field

When the icon  is displayed, it indicates that there are most recent alarms but the alarm conditions have disappeared. By clicking this icon, you can view recent alarms (up to 9 alarm messages are displayed) in the opened interface. You can also clear recent alarms by pressing the [**Reset**] key.

7. Alarm **AUDIO PAUSED** field

When the icon for 120-second alarm **AUDIO PAUSED** countdown, which is  **115 s**, is displayed, it indicates that the audible alarm tones are paused.

-
8. Gas supply icon field
By selecting this icon, you can check gas supply pressure, spare air source status and other information on the opened interface.
 9. USB icon field
The icon is highlighted when the system is connected to an identifiable USB device. By selecting this icon you can export screen, data and transfer settings in the opened interface.
 10. History icon field
By selecting this icon, you can check historical data on the opened interface, including graphic trends, tabular trends, setting trends and event logbook.
 11. Freeze icon field
Select this icon to enter freeze status. In this status, the system temporarily pauses the real-time refreshing of waveforms and loop graphs on the screen, so that you can review specific patient data.
 12. System time field
Displays current system time. By selecting this field, you can set the system time in the opened menu.
 13. Screen capture icon field
By select this icon, you can capture and save the screen.
 14. Power status icon field
Displays the status of currently-used power supply.
 15. Soft key field
Displays soft keys: Alarm Display, O₂↑/ Suction, Nebulizer, Tools, Lock, Menu, Standby and so on.
 16. Parameter setup quick key field
Displays ventilation setting parameters corresponding to the active ventilation mode.
 17. Ventilation mode setup field
Displays the keys for setting up ventilation modes.
 18. Waveforms/Spirometry/Values/Big Numeric Screen
Displays Waveforms, Spirometry, Values or Big Numeric Screen
 19. Trigger spontaneous breathing icon
Displays the icon when the patient has spontaneous breathing.

4.2 Waveforms Screen

Select the [Waveforms] key to access the interface as shown below.



Select  key and open the screen of graphic trend and dynamic lung as follows.



1. Graphic trend

2. Dynamic lung zone

4.2.1 Graphic trend

Graphic trend records the trend of parameter values. It is reflected through a curve. Every point on the curve corresponds to the value of monitored parameter at a specific time point.







Up to 30 minutes monitored parameter graphic trend could be displayed.

Select graphic trend parameter name area and set the monitored parameter graphic trend to be displayed in the pop-up interface. Adjust the cursor by selecting the graphic trend or twist the control knob after selecting the graphic trend.

4.2.2 PulmoSight

4.2.2.1 PulmoSight status

The brightness and darkness of lung diagram represents the inspiratory and expiratory process. When inspiration, the lung is bright. When expiration, the lung is dark.

PulmoSight status	Description	PulmoSight status	Description
	Compliance is normal.		Resistance is large. The airway edge thickened.
	Compliance is large. The alveoli contour is thinned.		Compliance is small. The alveoli contour is thickened.
	Volume is large.		Volume is low.

4.2.2.2 Set PulmoSight

Select  key, set [Ref. Compliance] and [Ref. Resistance] in the menu. There are three ways of setting parameters:

- Select setting parameter areas and direct edit.
- Select [Restore Defaults] key, and the system will automatically load the defaults corresponding to current patient type.
- Select [Use Current] key, and use the compliance monitored value and resistance monitored value displayed on the screen.

4.2.3 AMV Sight

When the ventilator is in the AMV ventilation mode, the Waveforms Screen displays AMV Sight and dynamic lung as follows.



AMV Sight

4.3 Spirometry Screen

Select the [Spirometry] key to access the screen as shown below.



The interface as shown below is displayed by pressing the key .



Spirometry loops reflect patient lungs function and ventilation condition as well, such as the patient's lungs compliance, over-inflation, breathing system leakage and airway blockage.

The system provides lung function loops, including [Paw-Volume] loop, [Flow-Volume] loop and [Flow-Paw] loop, the data for which is collected from the waveform data on pressure, flow and volume. When a mainstream CO₂ module is configured, a V-CO₂ curve

can be displayed. When the auxiliary pressure function is configured, [**Pes-Volume**] loop and [**Ptp-Volume**] loop can be displayed.

Up to two types of spirometry loop are displayed at a time. To select the desired loop:

1. Select [**Spirometry**] on the main screen.
2. Set the desired loop or V-CO₂ loop to be displayed.

The ventilator provides the function of reference loop. When [**Save Ref.**] is selected, the current respiratory cycle loop is saved as a reference loop, and the time it was saved is displayed. By selecting [**Display Ref.**] and then selecting a time point, the reference loop saved at that time can be viewed. By selecting [**Display Ref.**] and then selecting [**OFF**], the reference loop being displayed can be hidden.

The ventilator saves up to 5 reference loops. If 5 reference loops have already been saved, the system will automatically clear the oldest reference loop and save the loop of the current respiratory cycle as reference loop if [**Save Ref.**] is selected again.

Select the **[Review Ref.]** key to display the review reference loop menu.

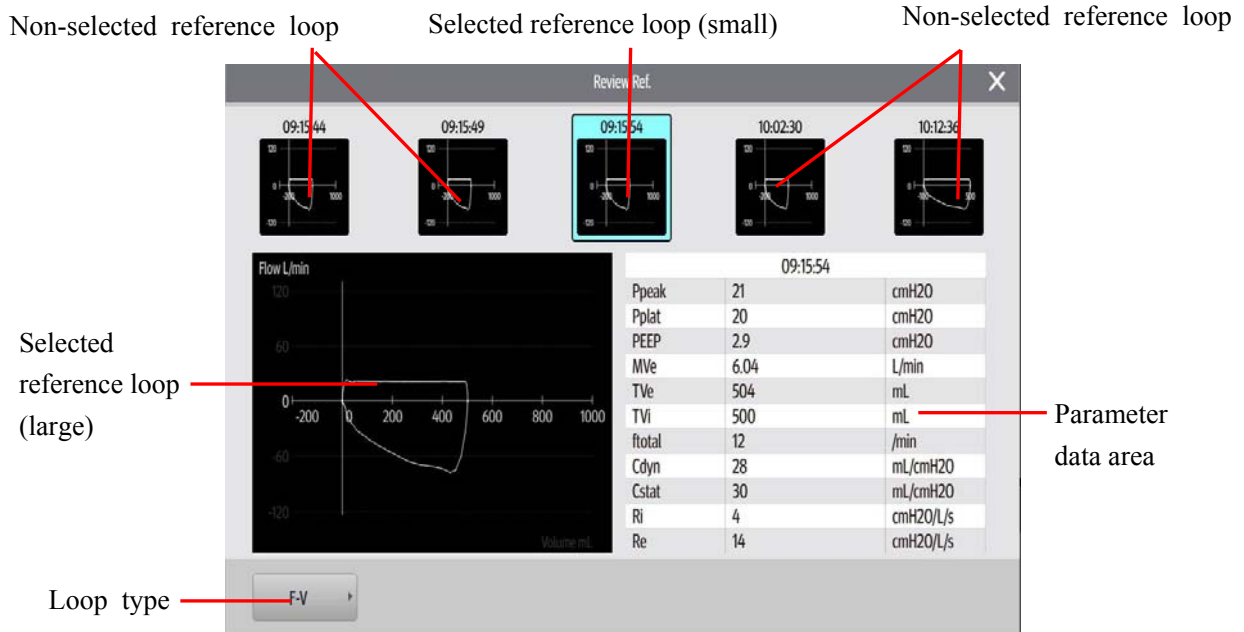

- **Small loop windows :** These small graphic windows show the reference loops. The reference loops (up to 5) are displayed from oldest (left) to newest (right). The information of selected reference loop is displayed in cyan highlight.
 - **Large loop window :** This graphic window shows an enlarged view of the selected reference loop.
 - **Loop type :** By selecting loop type, you can choose the type of loop to review.
- Parameter data area :** This area displays monitored parameter data related to the saved reference loops.

4.4 Measured Values Screen

Select the [Values] key on the screen to open the interface as shown below.



4.5 Big Numeric Interface

Select the [Big Numeric] key on the screen to open the interface as shown below.



4.6 History

Select the  key on the screen to access the interface as shown below. You can view tabular trend, graphic trend, setting trends, and event logbook in the History window.

4.6.1 Graphic Trend

Graphic trend records the trend of parameter values. It is reflected through a curve. Every point on the curve corresponds to the value of physiological parameter at a specific time point. Graphic trend also records parameter alarm events. Graphic trend data displays at one-minute intervals by default unless the zoom is selected.



Current cursor. The corresponding time displays above the cursor. If alarms occurred at that time, the corresponding alarm information will also be displayed above the cursor.

The parameter data of the time indicated by cursor.

Event marker. The dotted, colored line indicates a parameter alarm event occurred at that time. A parameter alarm event is indicated by a dotted line in the same color with alarm. If multiple events occurred, the dotted line is in the same color of the highest level alarm.

4.6.1.1 About Graphic Trend

- Graphic Trend displays the time and date on the horizontal axis.
- Graphic Trend displays the parameter data on the vertical axis.
- Graphic Trend displays the most recent trend data on the rightmost side.
- Graphic Trend is not stored when the machine is in standby status.
- The system can display a rolling 96 hours of continuous trend data.
- Graphic Trend highlights the parameter data in the corresponding alarm color if an alarm condition existed for the parameter at the time of trend record storage.
- Select [**Previous Event**] to move the cursor to the previous event from its current position.
- Select [**Next Event**] to move the cursor to the next event from its current position.

4.6.1.2 Zoom

In the Graphic Trend interface, you can set [**Zoom**] to [**5 min**], [**10 min**], [**15 min**], [**30 min**], [**1 h**] and [**2 h**].

4.6.1.3 Display Group

In the Graphic Trend window, you can set [**Display Group**] to [**Pressure**], [**Volume**], [**Time**], [**Gas**], [**SpO₂**], [**Other**] and [**All**].

4.6.2 Tabular Trend

You can view the patient's monitored parameter data and events under the Tabular Trend tab. Trend data displays at one-minute intervals by default.

	2019/11/08 10:06	2019/11/08 10:07	2019/11/08 10:08	2019/11/08 10:09	2019/11/08 10:10
Event					
Ppeak cmH2O	20	20	20	20	20
Pplat cmH2O	19	20	20	20	20
Pmean cmH2O	6.8	6.9	6.9	6.9	6.9
PEEP cmH2O	2.9	2.9	2.9	2.9	2.9
Pdrive cmH2O	17	17	17	17	17
ftotal /min	5	12	12	12	12
fspn /min	0	0	0	0	0
fmand /min	5	12	12	12	12
IE	1:1.9	1:1.9	1:1.9	1:1.9	1:1.9
Tinsp s	1.70	1.70	1.70	1.70	1.70
FIO2 vol.%	---	---	---	---	---
EtCO2 mmHg	0	0	0	0	0
VDaw ml	---	---	---	---	---

4.6.2.1 About Tabular Trend

- Tabular Trend displays the time and date on the horizontal axis.
- Tabular Trend displays the parameter data on the vertical axis.
- Tabular Trend displays the most recent trend data on the rightmost side.
- Tabular Trend is not stored when the machine is in standby status.
- The system can display a rolling 96 hours of continuous trend data.
- Tabular Trend highlights the parameter data in the corresponding alarm color if an alarm condition existed for the parameter at the time of trend record storage.
- Select [**Previous Event**] to move the cursor to the previous event from its current position.
- Select [**Next Event**] to move the cursor to the next event from its current position.

4.6.2.2 Interval

In the Tabular Trend window, you can set [**Interval**] to [**1 min**], [**5 min**], [**10 min**], [**15 min**], [**30 min**], [**1 h**], and [**2 h**].

4.6.2.3 Display Group

In the Tabular Trend window, you can set [Display Group] to [Pressure], [Volume], [Time], [Gas], [SpO₂], [Other] and [All].

4.6.3 Setting Trends

Setting Trends is used to record ventilation mode settings and parameter settings.



4.6.3.1 About Setting Trends

- Settings Trends displays the time and date on the horizontal axis.
- Settings Trends displays the ventilation mode and setting parameter on the vertical axis.
- Settings Trends displays the most recent trend data on the rightmost side.

4.6.4 Event Logbook

Event Logbook records such events as power-on/off, ventilation mode setup, ventilation parameter setup, technical alarm, physiological alarm, standby status, starting ventilation, new patient, last patient, special function, default settings management, calibration, system check, circuit test, PulmoSight set, and alarm **AUDIO PAUSED** and O₂ therapy event.

The screenshot shows the 'History' window with the 'Event Logbook' tab selected. A list of events is displayed on the left, with a cursor pointing to the first event: '2019-11-08 10:09:58 Paw Too Low'. To the right, a detailed parameter view for this event is shown, including Vent Mode (V-A/C), Ventilation Type (Invasive), Size (Adult), Working Mode (Non-Standby), FIO2 (--- vol%), TVe (508 mL), TVi (500 mL), MVe (6.10 L/min), ftotal (12 /min), fspn (0 /min), Pplat (20 cmH2O), Ppeak (20 cmH2O), Pmean (7 cmH2O), PEEP (2.9 cmH2O), and EtCO2 (0 mmHg). Navigation arrows are visible on the right side of the detailed view.

Event Time	Event Description	Severity
2019-11-08 10:09:58	Paw Too Low	High (Red !!!)
2019-11-08 10:09:56	TVe Too Low	Medium (Yellow !!)
2019-11-08 10:09:43	Paw Low Limit: OFF -> 29 cmH2O	Low (White)
2019-11-08 10:09:40	ftotal Too Low	Medium (Yellow !!)
2019-11-08 10:09:39	ftotal Low Limit: OFF -> 30 /min	Low (White)
2019-11-08 10:09:36	TVe Low Limit: 250 -> 555 mL	Low (White)
2019-11-08 10:09:32	MVe Too Low	High (Red !!!)
2019-11-08 10:09:31	MV Low Limit: 3.6 -> 6.7 L/min	Low (White)
2019-11-08 10:08:16	SpO2 Sensor Off	Medium (Yellow !)

Cursor

Detailed information of the event indicated by the cursor

4.6.4.1 About Event Logbook

- Event Logbook displays the most recent record at the top.
- The system can store up to 5000 records of Event Logbook.

NOTE

- The system can store up to 5000 records of Event Logbook. When a new event occurs after 5000 events are already stored, the new event overwrites the earliest one.

4.6.4.2 Filter

In the Event Logbook window, you can set [Filter] to [High Alarms], [Med Alarms], [Low Alarms], [All Alarms], [Operation Information], and [All Events].

4.7 Freeze

The freeze function's feature is that it can pause the real-time refreshing of waveforms and spirometry loops on the screen, so that you can have a close examination of the patient's status within this time period. The reviewed data are waveforms and spirometry loops in the 60 seconds before entering freeze state.

4.7.1 Enter Freeze Status

When in non-standby status and non-freeze status, press the [**Freeze**] key will display the [**Freeze active. Press the Freeze Key to Unfreeze**] prompt message on the screen and the system will enter freeze status. Freeze cursors will appear on the screen near the waveforms and loops. All displayed waves and loops are frozen, namely, they are not refreshed. The data in the parameter area are refreshed normally. In freeze status, the [Save Ref. Loop] key is disabled, and you cannot save a loop as a reference loop. However, you can view reference loops that are already saved.

4.7.2 View Frozen Waveforms

In freeze status, cursors appear on the waveforms. You can rotate the control knob clockwise or counterclockwise to move the cursor to view the waveforms.

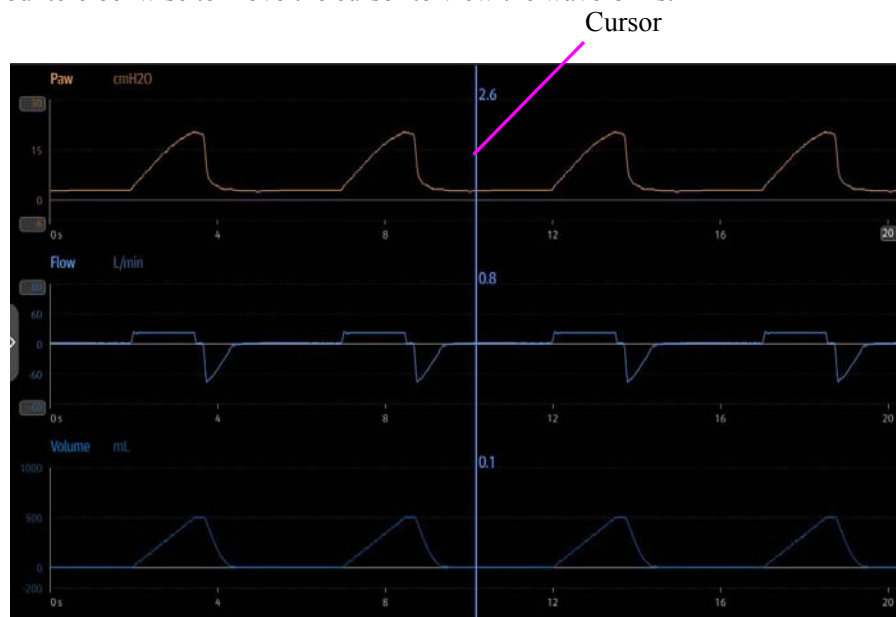

4.7.3 View Frozen Loop

In freeze status, cursors appear on the loops. You can rotate the control knob clockwise or counterclockwise to move the cursor to view the loops.

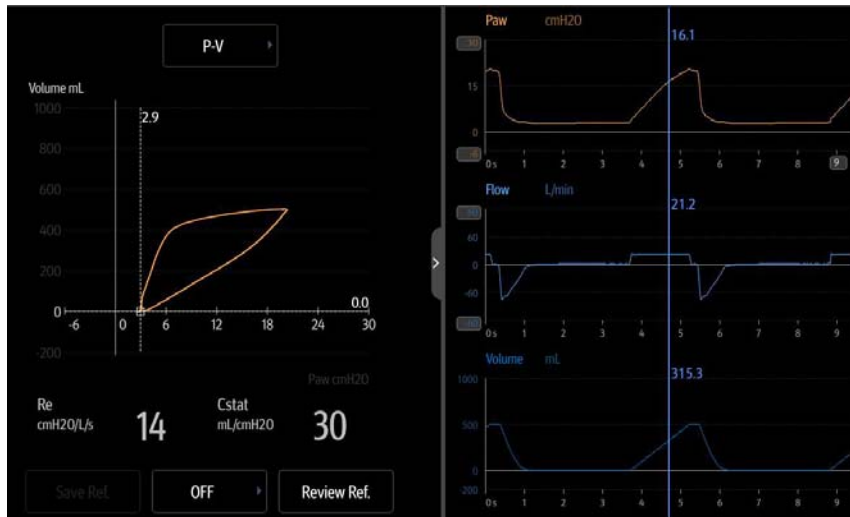

The interface as shown below is displayed by pressing the key .

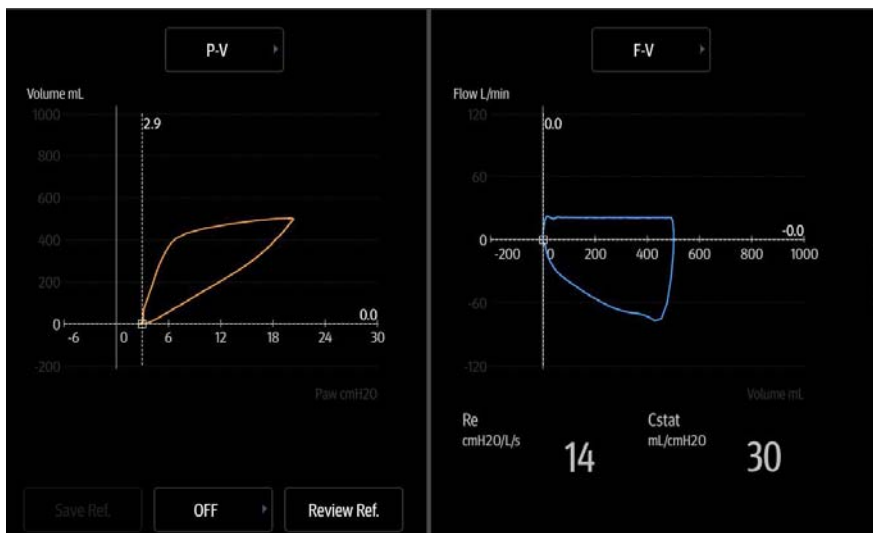

4.7.4 Exit Freeze Status

When in freeze status, press the [**Freeze**] key again to exit the freeze status. In freeze status, if no operation is performed on the ventilator for more than three (3) minutes, the system exits freeze status automatically.

4.8 Screen Capture

By pressing this key on the main screen , the system will capture and save the screen automatically. The screen capture is saved in “bmp” format. The system can store up to 20 screen captures.

4.9 Lock Screen

Press the [**Lock**] key on the main screen to enter locked status, and the prompt message [**Screen locked. Press the Lock button to unlock screen.**] will be displayed. During the period of screen locked, only , [**O₂↑ Suction**], and [**Lock**] keys are enabled. Touch screen, control knob, and other keys are disabled. Press this key a second time to unlock the screen.

FOR YOUR NOTES

5 System Settings

5.1 Date & Time Settings

1. Select the system time field on the main screen to pop up time setup menu.
2. Set [Date] and [Time].
3. Set [Date Format] to [YYYY-MM-DD], [MM-DD-YYYY] or [DD-MM-YYYY].
4. Set [Time Format]: [24 h] or [12 h].



5.2 Export to USB

The ventilator's exportation function provides the ability to export some data or settings to USB device.

5.2.1 Export Screen

Screen exportation involves exporting a saved screen capture for the ventilator. The exported file is saved in "bmp" format. This ventilator could save up to 20 screen captures.



To export screen capture,

1. Insert the USB device into the USB connector of the ventilator. The  key is highlighted on the main screen.
2. By selecting the  key, the system will open the USB settings interface.
3. On the opened interface, select the [Export Screenshot] tab first and then click the [Export Screenshot] key. The system will run a check to verify that there is enough storage space available on the USB device. If there is sufficient space, the system will start to export the screen.
4. After exporting is completed, select [Remove USB Device] to remove the USB device.

5.2.2 Export Data

Exporting data means to export data from the ventilator, such as patient demographics, current setting parameters, current alarm limits, trend data and so on.

To export data,

1. Insert the USB device into the USB connector of the ventilator. The  key is highlighted on the main screen.
2. By selecting the  key, the system will open the USB settings interface.

-
3. On the opened interface, select the [**Export Data**] tab and then select the [**User Export**] key. The system will run a check to verify that there is enough storage space available on the USB device. If there is sufficient space, the system will export data including patient information, current parameter settings, current alarm limits, tabular trend, PEEP_i measured value, P_{0.1} measured value, V_{trap} measured value, and NIF measured value, etc. The format of the exported data is “html”.
 4. If you need to export calibration data, event logbook and self-check logbook in addition to the above data, select the [**Factory Export**] tab and enter password. The system will run a check to verify that there is sufficient storage space available on the USD device. If there is sufficient space, the system will start to export data. The exported data is encrypted in the format of “blg”.
 5. After exporting is completed, select [**Remove USB Device**] to remove the USB device.



NOTE

-
- **If you need to check the exported data in format of “blg”, please contact the Customer Service Department.**
-



5.2.3 Transfer Settings

You can export or import settings, while unit is in standby.

To export settings,

1. Make sure that the machine is in Standby status.
2. Insert the USB device into the USB connector of the ventilator. The key is highlighted on the main screen .
3. By selecting the  key, the system will open the USB settings interface.
4. Select [**Transfer Settings**] → Enter system password → [**Export Settings**] in the opened interface. The system will run a check to verify that there is sufficient storage space available on the USB device. If there is sufficient space, the system will save the current settings and machine defaults to the USB device.
5. After exporting is completed, select [**Remove USB Device**] to remove the USB device.

To import settings,

1. Make sure that the machine is in Standby status.
2. Insert the USB device into the USB connector of the ventilator. The key is highlighted on the main screen .
3. By selecting the  key, the system will open the USB settings interface.
4. Select [**Transfer Settings**] → Enter system password → [**Import Settings**] in the opened interface. The system will upload the Ventilator settings saved in the USB device.
5. After exporting is completed, select [**Remove USB Device**] to remove the USB device.

5.3 Basic Settings

5.3.1 Set Flow/Tpause(%)

1. Select [**Menu**]→[**Setup**]→[**Ventilation**].
2. Set [**Flow/Tpause(%)**] and toggle between [**Flow**] and [**Tpause(%)**]. Use corresponding ventilation settings in the V-A/C, V-SIMV or CPRV ventilation mode, according to [**Flow/Tpause(%)**].

5.3.2 Set Tinsp/I:E

1. Select [**Menu**]→[**Setup**]→[**Ventilation**].
2. Set [**Tinsp/I:E**] and toggle between [**Tinsp**] and [**I:E**]. Based on [**Tinsp/I:E**], adopt the corresponding Tinsp or I:E ventilation parameter settings for the V-A/C, P-A/C, PRVC, CPRV and DuoLevel (when the time parameter for DuoLevel is [**f**]) ventilation modes.

5.3.3 Set IBW/Height

1. Select [**Menu**]→[**Setup**]→[**Ventilation**].
2. Set [**IBW/Height**] and toggle between [**IBW**] and [**Height**]. When the ventilator is in the standby mode, set the ideal body weight or height. The system calculates default values of TV, f, and fapnea in the ventilation mode automatically based on the set IBW or height and gender.

5.3.4 Set TV/IBW

1. Select **[Menu]**→**[Setup]**→**[Ventilation]**.
2. Set **[TV/IBW]**: set to an appropriate ratio. The system will calculate the default tidal volume (TV) in the ventilation mode depending on **[TV/IBW]**.

5.3.5 Setup DuoLevel

1. Select **[Menu]**→**[Setup]**→**[Ventilation]**.
2. Set **[DuoLevel Setup]**: **[Thigh]** or **[f]**.
 - ◆ In case of DuoLevel ventilation mode, the settable time control parameters are **[Thigh]** and **[Tlow]** if **[DuoLevel Setup]** is set to **[Thigh]**.
 - ◆ In case of DuoLevel ventilation mode, the settable time control parameters are **[f]** and **[Tinsp]** if **[DuoLevel Timing]** is set to **[f]** and **[Tinsp/I:E]** is set to **[Tinsp]**.
 - ◆ In case of DuoLevel ventilation mode, the settable time control parameters are **[f]** and **[I:E]** if **[DuoLevel Timing]** is set to **[f]** and **[Tinsp/I:E]** is set to **[I:E]**.



5.3.6 Set Invasive Apnea Mode

1. Select **[Menu]**→**[Setup]**→**[Ventilation]**.
2. Set **[Invasive Apnea Mode]**: **[Volume Control]** or **[Pressure Control]**. In case of invasive ventilation in V-SIMV, P-SIMV, PRVC-SIMV, CPAP/PSV, PSV, VS, DuoLevel and APRV mode, the settable apnea ventilation control parameter is **[TVapnea]** if **[Invasive Apnea Mode]** is set to **[Volume Control]**, and is **[ΔPapnea]** if **[Invasive Apnea Mode]** is set to **[Pressure Control]**.

5.3.7 Set O₂% increment during O₂↑ period

1. Select **[Menu]**→**[Setup]**→**[Ventilation]**.
2. Set **[Increase O₂% during O₂↑]**: set oxygen enrichment in accordance with different patient types. After initiation of oxygen enrichment, the system will compare “current oxygen concentration + oxygen enrichment” with “100vol.%” and start ventilation according to the lower of the two values.

5.3.8 Set Oxygen Sensor Monitoring

1. Select [Menu]→[Setup]→[O₂ Sensor].
2. Set the [Monitoring]:  (ON) or  (OFF). When the switch is ON, oxygen concentration of patient's inhaled gas can be monitored. You can switched off if oxygen concentration monitoring function accompanying the ventilator is not needed. In this case, the [O₂ Monitoring Off] prompt message is displayed on the screen. After Oxygen Sensor Monitoring off, the ventilator will disable relevant alarm messages and prompt messages.

CAUTION



- **Switching off oxygen concentration monitoring is allowable. To prevent potential patient injury, it is suggested not to switch off oxygen concentration monitoring continuously.**

NOTE



- **The system total response time for oxygen concentration monitoring is 23s.**
 - **It takes approximately 3 minutes from powering on the ventilator to reaching the oxygen concentration monitoring performance specified in section B.7 of this manual.**
-

5.4 Screen Settings



5.4.1 Adjust Screen Brightness

1. Select [Menu] → [Screen] → [Brightness/Volume].
2. Select  or  and switch to corresponding screen brightness default.
3. If the above screen brightness is not satisfactory, set [Brightness] directly: 1 to 10. T1 is the darkest setting and 10 is the brightest. If the ventilator is battery powered, you can select a less bright screen to save battery capacity.

5.4.2 Adjust Key Volume

1. Select [Menu] → [Screen] → [Brightness/Volume].
2. Select  or  and switch to corresponding key volume default.
3. Set [Key Volume]: 0 to 10. Select 0 to turn off key sound and 10 to obtain maximum key volume.

5.4.3 Screen Setup

1. Select [Menu] → [Screen] → [Screen Setup].
2. Select corresponding icons to set the displayed number of waveforms and the wave drawing method.
3. If you need to adjust the specific waveform and measured values at each position, please set [Layout Setup Switch] as  (ON). Then select the waveform or measured value in the main screen and set the required waveform or measured value name in the interface that is displayed. If you need to close this function, please set [Layout Setup Switch] to  (OFF).
4. Select [Defaults] when necessary to restore the settings to default.

5.4.4 Color Settings

1. Select [Menu]→[Screen]→[Color].
2. Set the parameter display colors. The colors of waveform, parameter, spirometry loop, and parameter alarm limit are linked. If you set waveform or parameter color, the color of the relevant parameter, waveform, or spirometry loop also changes. The color of related parameter alarm limit will be a darker shade of the set color.

The following table lists the waveforms, related parameters, related spirometry loop and alarm limits.

Waveforms	Parameter	Related spirometry loop	Related alarm limits
Airway Pressure	Ppeak, Pmean, Pplat, PEEP	P-V loop, F-P loop	Paw
Flow	MVi, MVe, MVleak, MVspn, TVe, TVi, TVe spn, ftotal, fmand, fspn, TVe/IBW, I:E, Tinsp, PIF, PEF	F-V loop	MVe, TV, ftotal
Volume	/	/	/
/	Ri, Re, Cdyn, Cstat, RCexp, RSBI, C20/C, WOBtot, WOBvent, WOBimp	/	/
/	FiO ₂	/	FiO ₂
CO ₂	EtCO ₂ , VDaw, VDaw/TVe, Vtalv, MValv, slopeCO ₂ , VeCO ₂ , ViCO ₂ , VDalv, VDphy, VDphy/TVe, OI, PF, MVCO ₂	V-CO ₂ curve	EtCO ₂
Pleth	SpO ₂ , PR	/	SpO ₂ , PR

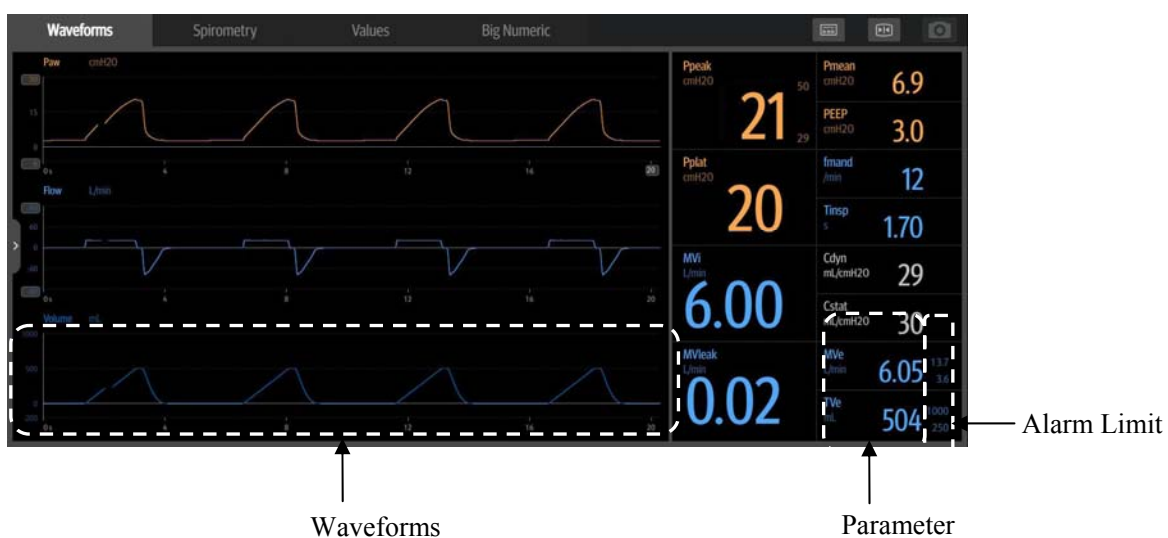

5.5 System Settings

5.5.1 Set Language

1. Select [**Menu**]→[**System**]→Enter system password→[**Setup**].
2. Select [**Language**] and select the desired language.
3. Restart the ventilator to activate the selected language.

5.5.2 Set Unit

5.5.2.1 Set Weight Unit

1. Select [**Menu**]→[**System**]→Enter system password→[**Setup**].
2. Set [**Weight Unit**]: [**kg**] or [**lb**].

5.5.2.2 Set Height Unit

1. Select [**Menu**]→[**System**]→Enter system password→[**Setup**].
2. Set [**Height Unit**]: [**cm**] or [**inch**].

5.5.2.3 Set Paw Unit

1. Select [**Menu**]→[**System**]→Enter system password→[**Setup**].
2. Set [**Pressure Unit**]: [**cmH2O**], [**hPa**] or [**mbar**].

5.5.2.4 Set CO₂ Unit

1. Select [**Menu**]→[**System**]→Enter system password→[**Setup**].
2. Set [**CO₂ Unit**]: [**mmHg**], [**kPa**] or [**Vol.%**].

5.5.3 Set Minimum Alarm Volume

1. Select [**Menu**]→[**System**]→Enter system password→[**Setup**].
2. Set [**Minimum Alarm Volume**] to an appropriate value.

5.5.4 Default Settings

The ventilator provides the following types of settings:

- Factory default settings, namely, values of factory preset setting items. There are three groups of default settings —adult, pediatric and neonate— based on patient type.
- User Defaults. You can change the ventilator’s default settings based on the current settings during ventilation and save the changed settings as user default settings. There are three groups of user default settings —adult, pediatric and neonate patients— based on patient type.
- Recent settings. In actual application, operators may change some settings. The ventilator stores these settings in real time. The stored settings are recent settings.
- Current settings, namely current settings of the ventilator.

5.5.4.1 Save Current Settings

You can change the ventilator’s default settings based on the settings during ventilation and save the changed settings as default settings.

1. Select [**Menu**]→[**System**]→Enter system password→[**Defaults**].
2. Select [**Use Current Settings**] to save the current settings as default settings.

5.5.4.2 Restore Factory Default Settings

You can restore factory default settings manually as required, while unit is in standby status.

1. Select [**Menu**] → [**System**] → Enter system password → [**Defaults**].
2. Select [**Restore factory defaults**] to restore the factory default settings.

5.5.4.3 Default Setting Application

When the ventilator is used on a new patient after being turned on, the system loads the corresponding default settings based on the selected patient type. When the ventilator is used on the same patient after powered on, the system adopts recent settings automatically.

5.5.4.4 Restore Recent Settings Automatically

When the ventilator is used on the same patient after powered on, the system adopts recent settings automatically.



NOTE

- Records information automatically saved by the system including reference loop, monitored trend, event log (including alarm log), setting trend, special function measured values (including PEEPi, NIF, P0.1, P-V Tool measured values, and alveolar ventilation calculated values), patient settings and equipment settings (including alarm settings). When there are changes in these data, the system stores the changed data in the flash memory chips of the main board automatically. When the ventilator restarts, the data are restored automatically.
-

5.5.5 Set Nurse Call

Refer to *11.13 Nurse Call* section.

5.5.6 Set Network

1. Select [Menu]→[System]→Enter system password→[Interface Setting].
2. Select [LAN Setup] tab, set [IP Config.], [IP Address], [Subnet Mask] and [Gateway] in the opened interface. In addition, the opened interface displays the MAC address of the ventilator.
3. If necessary, select [HL7] tab, set [Destination IP], [Port], and [Interval] in the opened interface. Select [Test] soft key to confirm the network connection. When the connection is normal, set [Send Waveforms] or [Send Alarms] to  (ON), the ventilator will send the waveforms or the alarms.
4. If necessary, select [SNTP] tab, set [Interval], [Primary Server IP Address], and [Secondary Server IP Address] in the opened interface. Select [Test] soft key to confirm the network connection.
5. If necessary, select [Serial] tab, set [Protocol], [Baud Rate], [Data Bits], [Stop Bits], [Parity], [Interval], and [Compatibility] in the opened interface. The [Protocol] can be set to [None], [MR-WATO] or [Philip]. When the [Send Alarms] is set to  (ON), the ventilator will send the alarms.

5.5.7 View System Information

5.5.7.1 Version Information

Select [Menu] → [System] → Enter system password → [System info.] → [Versions] to check the system software version.

5.5.7.2 Configuration Information

Select [Menu] → [System] → Enter system password → [System info.] → [Config Info.] to view the configuration information of the ventilator such as ventilation mode.







5.5.7.3 Maintenance Information

Select [Menu] → [System] → Enter system password → [System info.] → [Maintain] to view the system total running time, system startup time, CO₂ last calibration time, O₂ sensor last calibration time, flow sensor last calibration time, time left for the next backup air supply maintenance, and time of last maintenance.

5.6 Set Tool Shortcut Key

1. Select [Tools]→[Shortcut Key Setup].
2. Select the required shortcut key in the menu that displays. The system will add shortcut keys one at a time in the order of selection.

5.7 Set Gas Supply

1. Select the icons of gas supply status ( or )→[Information], to view the gas supply pressure or status and other information in the accessed menu.
2. Select [Settings] tab, set [Air Pipeline] to  (ON), or  (OFF), or set [Backup Air Supply] to  (ON), or  (OFF). When both [Air Pipeline] and [Backup Air Supply] are set to on, the system will select Air Pipeline firstly. When [Air Pipeline] is set to on and [Backup Air Supply] is set to off, the system will select air pipeline. When [Air Pipeline] is set to off and [Backup Air Supply] is set to on, the system will select backup air supply.

NOTE

- For the ventilator equipped with backup air supply, disabling Backup Air Supply is not recommended, so as to activate backup air supply when the air tubing doesn't work.
 - When both [Air Pipeline] and [Backup Air Supply] are set to on, the system will select Air Pipeline firstly.
 - [Air Pipeline] and [Backup Air Supply] could not be set to off at the same time.
-

5.8 Factory Service Settings

Only the company's authorized maintenance staff can access the [Service] tab. For further assistance, please contact the company's Customer Service Department.

6 Start Ventilation

6.1 Turn on the System

1. Insert the power cord into the power receptacle. Ensure the external power indicator light is lit.
2. Press the  hard key.
3. The alarm indicator light flashes yellow and red once in turn, and then the system conducts a self check of the speaker and buzzer once respectively.
4. A start-up screen and start-up check progress bar appear. Then the System Check screen is displayed.

NOTE

- **When the ventilator is started, the system detects whether audible alarm tones and alarm lamp function normally. If yes, the alarm lamp flashes yellow and red successively, and the speaker and the buzzer give check tones. If not, do not use the equipment and contact us immediately.**
-

6.2 System Check

CAUTION

- **If the ventilator fails any tests, remove it from clinical use. Do not use the ventilator until necessary repairs are completed and all tests have passed.**
 - **Before running System Check, disconnect the patient from the equipment and ensure that a backup ventilation mode is available for patient ventilation.**
-

To enter the System Check screen,

- The System Check screen is accessed automatically after powering on the system.
- On the non-standby screen, select the [Standby] key and enter the Standby status after your confirmation. Select the [System Check] key in the Standby status to enter the System Check screen.

The system check screen displays the last system check time and total system check result. Select the  key to query the last system check information of the ventilator system, including system check items and System Check results.

Connect the gas supply and block the Y piece as illustrated. Then select [Continue] to start System Check item by item.

System Check items include:

- Backup Air Supply Test: test the speed of backup air supply.
- O₂ Flow Sensor Test: test the O₂ Insp. Valve and O₂ Flow Sensor.
- Air Flow Sensor Test: test the Air Insp. Valve and Air Flow Sensor.
- Exp. Flow Sensor Test: test the expiratory flow sensor.
- Pressure Sensor Test: test the pressure sensors at the inspiratory and expiratory ports.
- Exp. Valve Test
- Safety Valve Test
- Leakage (mL/min)
- Compliance (mL/cmH₂O)
- Circuit Resistance (cmH₂O/L/S)
- O₂ Sensor Test
- Neonatal Flow Sensor Test

System Check result can be:

- Pass: indicates that check of this item is completed and is passed;
- Fail: indicates that check of this item is completed but is failed;
- Cancel: indicates that check of this item is cancelled;
- No Gas Supply: indicates that air or O₂ sources are not connected.
- Monitoring Off: indicates that sensor monitoring function may not be switched on when O₂ sensor test or neonatal flow sensor test is being carried out.
- No Sensor: indicates that the neonatal flow sensor is not connected.
- Sensor Reversed: indicates that the neonatal flow sensor is connected reversed.
- Sensor Failure: indicates that the oxygen sensor may not be working.
- High leakage: indicates that there is high leakage from the test tubing, probably because the tubing is disconnected, not properly installed, the safety valve is not closed, or the expiratory valve membrane is not installed.

Total selftest results are listed as follows after all selftest items have been completed:

- Pass: all selftest items successfully pass the selftest.
- Partially Pass: some selftest items fail, but the mechanical ventilation is allowed.
- Fail. Ventilation Disabled: some important selftest items fail, but the mechanical ventilation is not allowed.
- High Leakage, Ventilation Disabled: Exp. Flow Sensor Test, Pressure Sensor Test, Exp. Valve Test, or Safety Valve Test fails, the mechanical ventilation is not allowed.
- Cancel: some selftest items cancelled and other selftest items have been successfully passed.

During System Check, the system prompts [**Running**] on the right side of the current check item. At the time, by selecting the [**Skip**] key, the system will immediately stop checking the item and simultaneously enter the next self check item. By select the [**Stop**] key, the system will stop the check of the current item and the checks of remaining items immediately, and display [**Cancel**] as the check result.

If the ventilator uses the O₂ cell, when the oxygen sensor test fails, the [**O₂ Calibration**] key is displayed. Press this key to open the oxygen concentration calibration menu, and then calibrate oxygen concentration.

When checks of all items are completed, if you select [**Retry**], the system starts a new round of checking. If you select [**Standby**], the system exits the check and enters Standby status.

6.3 Circuit Test

WARNING

- **To ensure optimum performance of the ventilator, re-perform the tubing test each time after changing the patient type, replacing the accessories or components like patient tubing, humidifier, and filter.**
-

CAUTION

- **Before performing the tubing test, disconnect the patient from the equipment and ensure that a backup ventilation mode is available for the patient's ventilation.**
-

NOTE

- **Circuit test is not required if a System Check has been run.**
-

To enter the tubing test interface: Press the [**Standby**] key in a non-standby position, and confirm to enter standby. Press the [**Circuit Test**] key in a standby position to enter the tubing test interface.

The tubing test interface will display the time of the most recent tubing test and total test results. Select the key  to review the ventilator system's tubing test information, including test items and results.

Connect the gas supply and block the Y piece as illustrated. Then select [**Continue**], the system will start self check item by item.

Tubing test include the following items:

- Leakage (mL/min)
- Compliance (mL/cmH₂O)
- Circuit Resistance (mL/cmH₂O/L/s)
- Neonatal Flow Sensor Test

The test results of the above tubing test projects are listed as below:

- Pass: indicates that the check of this item has been completed and passed;
- Fail: indicates that the check of this item has been completed but failed;
- Cancel: indicates that the check of this item has been cancelled;
- Monitoring Off: indicates that sensor monitoring may not be turned on during oxygen sensor test or neonatal flow sensor test.
- No Sensor: indicates that the neonatal flow sensor is not connected.
- Sensor Reversed: indicates that the neonatal flow sensor is connected reversed.

After the circuit test project has been completed, total testing results are listed below:

- Pass: all test items successfully pass the test.
- Partially Pass: some test items successfully pass the test.
- Fail: all test items fail.
- Cancel: some test items are cancelled and other test items have been successfully passed.

During circuit test, the system prompts [**Running**] on the right side of the current check item. At the time, select [**Skip**] key, and the system will immediately stop the checking of the time and enter the next item at the same time. If you select [**Stop**], the system stops the check of the current item and also the checks of the remaining items immediately, and displays [**Cancel**] as the check result.

When checks of all items are completed, if you select [**Retry**], the system starts a new round of checking. Press the [**Standby**] key and enter Standby status.

6.4 Select Patient

6.4.1 Set Patient Information on the Ventilator

Open the patient setting menu in standby and select the patient information:

- If selecting [**Last Patient**], please set [**Gender**], [**Height**]/[**IBW**] and [**Ventilation Type**] in the open [**Last Patient**] menu.
- If selecting [**New Patient**], please set [**Patient Size**], [**Gender**], [**Height**]/[**IBW**] and [**Ventilation Type**] in the accessed [**New Patient**] menu.
- Upon alteration of [**Gender**], [**Height**] or [**IBW**], the settings of [**TV**], [**TVapnea**], [**f**] and [**fapnea**] will change accordingly, as well as tidal volume high alarm limit, tidal volume low alarm limit, minute ventilation high alarm limit and minute ventilation low alarm limit.

Open the patient settings menu in ventilation and enter the patient information:

- If selecting [**Last Patient**], please set [**Gender**], [**Height**]/[**IBW**] in the open [**Last Patient**] menu.
- If [**New Patient**] is not selected, it will not be possible to open the [**New Patient**] menu.
- Upon alteration of [**Gender**], [**Height**] or [**IBW**], the settings of [**TV**], [**TVapnea**], [**f**] and [**fapnea**] will remain unchanged, as well as tidal volume high alarm limit, tidal volume low alarm limit, minute ventilation high alarm limit and minute ventilation low alarm limit.

6.4.2 Getting Patient Information from the ADT Server

The ventilator can connect with the Admit-Discharge-Transfer (ADT) server through the eGateway, and the ventilator can load the patient information from ADT server.

To load patient information from the ADT server, perform the following procedure:

1. Connect the network cables.
2. Select [**Menu**]→[**System**]→Enter system password→[**Interface Setting**].
3. Select [**LAN Setup**] tab, set [**IP Config.**], [**IP Address**], [**Subnet Mask**] and [**Gateway**] in the opened interface. In addition, the opened interface displays the MAC address of the ventilator.
4. Select [**eGateway**] tab and set the [**eGateway**] to  (ON) in the opened interface. Then set the [**IP Address**] of eGateway and ADT. Normally, there is no need to set the [**Port**], but you can change it as required.
5. Ensure the network status is [**Connected**] in the [**eGateway**] tab.
6. Select the patient type field on the main screen and open the patient setting menu.
7. Select [**Find Patient**], input [**Patient ID**] and [**Visit Number**] in the opened interface.
8. Select [**Query**]. Then list pops up, including all the patients that meet the query criteria.

-
9. Select a patient from the patient list, and then select [**Import**]. The imported data includes patient ID, visit number, first name, last name, bed number, room number, department, and facility.

NOTE

-
- The IP address of the ventilator, eGateway and ADT must be on the same subnet.
 - When the [eGateway] is set to  (ON), the ventilator can send the ventilation mode, ventilation type, monitored parameters, controlled parameters, waveforms and alarm limits data to the eGateway.
-

6.5 Ventilation Type

The ventilator provides two ventilation types: invasive and non-invasive.

WARNING

- Check the alarm limit settings after switching over from NIV to Invasive.
-
-

6.5.1 Invasive Ventilation

Invasive ventilation means to ventilate the patient through manual airway (ET tube or Trach tube). In invasive ventilation, the enabled ventilation modes include:

- Adult patients: V-A/C, P-A/C, V-SIMV, P-SIMV, CPAP/PSV, PRVC, PRVC-SIMV, DuoLevel, APRV, VS, AMV, and CPRV ventilation modes.
- Pediatric patients: V-A/C, P-A/C, V-SIMV, P-SIMV, CPAP/PSV, PRVC, PRVC-SIMV, DuoLevel, APRV, VS, and AMV ventilation modes.
- Neonate patients: V-A/C, P-A/C, V-SIMV, P-SIMV, CPAP/PSV, PRVC, PRVC-SIMV, DuoLevel, APRV, and VS ventilation modes.

Select the invasive ventilation type icon  and then select [**ATRC**] in the opened page to set relevant parameters. For settings, refer to **6.7.3** Automatic Tube Resistance Compensation (ATRC).

 **WARNING**

- **Incorrect tube type, ID or compensate setting can endanger the patient. Make sure to set them properly.**
-

 **CAUTION**

- **Do not attempt to use NIV on intubated patients.**
-

6.5.2 Non-Invasive Ventilation (NIV)

NIV means to ventilate the patient by using a nasal mask or facial mask instead of ET tube or Trach tube. In NIV, the enabled ventilation modes include:

- **Adult and pediatric patients: CPAP/PSV, P-A/C and PSV-S/T ventilation modes.**
 - **Neonate: P-A/C, PSV, nCPAP and PSV-S/T ventilation modes.**
-

 **CAUTION**

- **Do not use NIV on patients with no or irregular spontaneous breaths. NIV is intended to provide supplemental ventilatory support to patients with regular spontaneous breaths.**
 - **Do not attempt to use NIV on intubated patients.**
-

6.5.3 Set Ventilation Type

To set ventilation type,

1. Select the patient type icon,  or select [**Last Patient**] or [**New Patient**] in the standby mode.
2. Set the [**Ventilation Type**] to [**NIV**] or [**Invasive**] on the accessed screen.

6.6 Ventilation Mode

NOTE

- At the expiratory phase, the ventilator will not automatically generate negative pressure. However, it may cause negative pressure because patients inhale air.
 - The user can set high pressure alarm limit. If the pressure reaches the high pressure alarm limit in the inspiratory phase, the [Paw Too High] high-level alarm is triggered. The ventilator opens the expiration valve and switches to expiratory phase until the airway pressure reaches the preset PEEP value. If the airway pressure exceeds high pressure alarm limit+5 cmH₂O (adjustable pressure limit), the ventilator opens the safety valve to release pressure, so that the airway pressure falls to less than 3 cmH₂O for continuous 0.5 s. Make sure to set high pressure alarm limit properly to ensure patient safety.
 - As false triggering of the ventilator can easily be caused by negative pressure produced during closed suction, it is recommended that the pressure-controlled ventilation mode (P-A/C mode or P-SIMV mode), in which ventilation trigger can be turned off, be used first. The operator should complete ventilation parameter settings in accordance with the patient's condition.
 - In the inspiratory phase, waveforms turning red indicates that the patient has spontaneous inspiration or the pressure support ventilation is triggered in V-SIMV, P-SIMV, PRVC-SIMV, CPAP/PSV, Duolevel, APRV, VS, AMV, PSV-S/T or nCPAP mode.
-

6.6.1 Ventilation Mode and Parameter Setup





1. Ventilation mode field

Displays the keys for setting up ventilation modes.

2. Parameter setup quick key field



Displays ventilation parameter settings corresponding to the ventilation mode. Select

 to display more parameter settings. Select  to display all parameter settings corresponding to the mode, including sigh function parameters. Ventilation parameters vary subject to the ventilation mode.

3. Ventilation mode custom key

In the standby status, select ventilation mode custom key  to open ventilation mode setting menu. In the opened menu, set the ventilation mode to be displayed in Area 1. The system will add the ventilation modes one at a time in the order of selection.

4. CPRV ventilation mode area (settable)

In the standby mode, select the Ventilation mode custom key  to open ventilation mode setting menu. In the accessed menu, set [CPRV] to  (ON), and then the CPRV ventilation mode will be shown on the area 4. Set [CPRV] to  (OFF), then the CPRV ventilation mode won't be shown on the area 4.

To set ventilation mode,

1. In the ventilation mode area, select the required ventilation mode key, and the ventilation parameters can be set in this ventilation mode will be displayed in the opened menu.
2. Select the key for the ventilation parameter to be set.
3. Press the control knob, and then turn it to set the selected parameter to the appropriate value.
4. Press the control knob again to confirm the setting.
5. Set other parameters in the same way.
6. Select the **[Ok]** key after completing the parameter settings.

To set quick key ventilation parameters,

1. In the parameter setup quick key field, select the ventilation parameter to be set.
2. Press the control knob, and turn it to set the selected parameter to the appropriate value.
3. Press the control knob to confirm the setting.
4. Set other parameters in the same way.

6.6.2 V-A/C

V-A/C is volume-assist/control ventilation mode. In V-A/C mode, a certain tidal volume is delivered to the patient within a certain period of gas delivery time. During the expiratory phase, V-A/C mode supports synchronization trigger. Namely, when the ventilator detects patient inspiratory effort, it delivers next mechanical ventilation in advance.

The following figure shows typical waveforms in V-A/C mode.

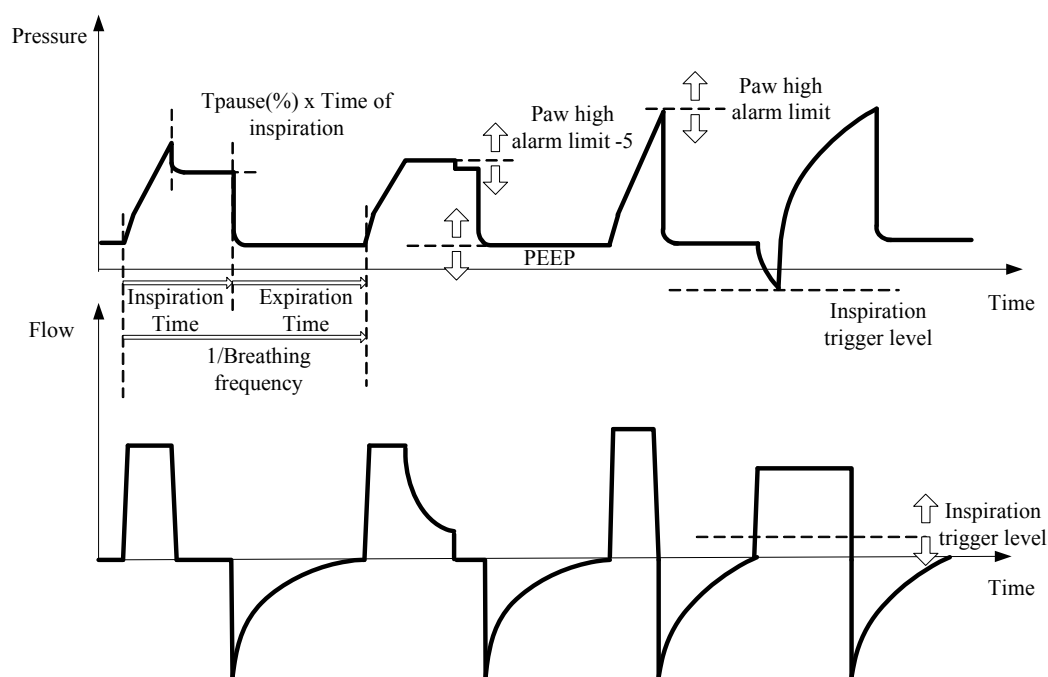

In V-A/C mode, you need to set the following basic ventilation parameters:

[O ₂ %]:	Oxygen concentration
[TV]:	Tidal volume
[T _{insp}] or [I:E]:	Inspiration time or ratio of inspiratory time to expiratory time
[f]:	Breathing frequency
[PEEP]:	Positive end-expiratory pressure
[Assist]:	Switching trigger ON/OFF
[F-Trig] or [P-Trig]:	Inspiration trigger level
[T _{pause} (%)] or [Flow]:	Percent of inspiratory pause time or flow delivered to the patient in the inspiratory phase

6.6.3 P-A/C

P-A/C is pressure-assist/control ventilation mode. In P-A/C, the patient's airway pressure rises to the preset pressure level within the time of pressure rising during the inspiration phase, and is held at this level till inspiration time is completed. Then the system switches to expiration. When the airway pressure is held at the preset pressure level, delivered gas flow has decelerating shape, and varies with the resistance and compliance of the patient's lungs. During the inspiratory phase, when the volume of gas delivered exceeds the tidal volume high alarm limit, the system switches to the expiratory phase immediately. During the expiratory phase, synchronization trigger is supported. Namely, when the ventilator detects patient inspiratory effort, it delivers next mechanical ventilation breath immediately. The following figure shows typical waveforms in P-A/C mode.

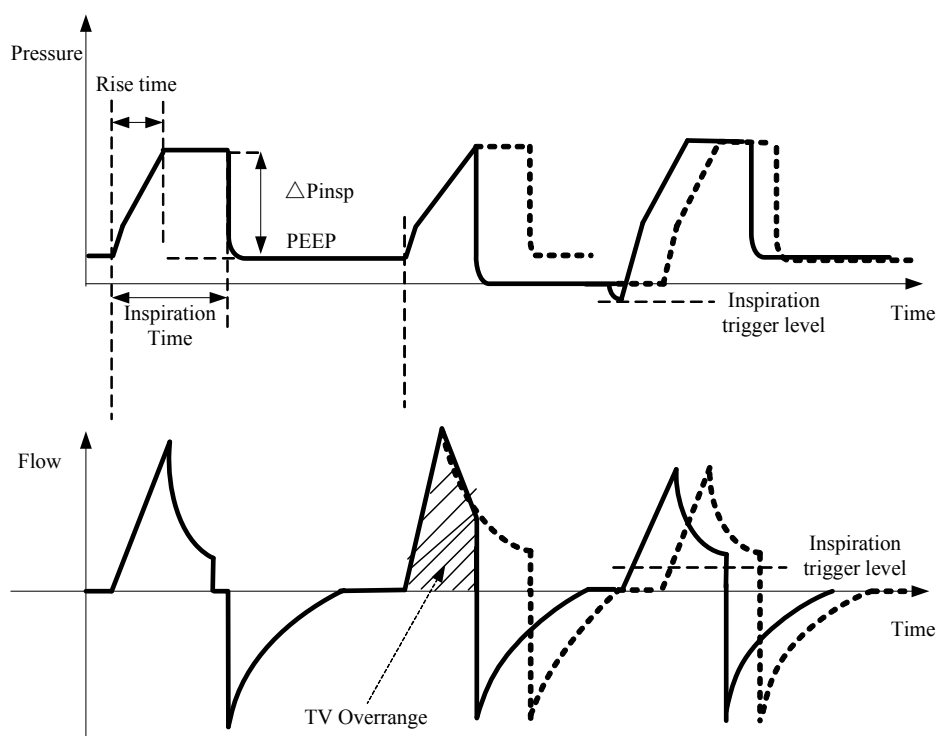

In P-A/C mode, you need to set the following basic ventilation parameters:

[O ₂ %]:	Oxygen concentration
[ΔP_{insp}]:	Inspiratory pressure
[T _{insp}] or [I:E]:	Inspiration time or inspiratory/expiratory time ratio.
[f]:	Breathing frequency
[PEEP]:	Positive end-expiratory pressure
[Assist]:	Switching trigger ON/OFF
[F-Trig] or [P-Trig]:	Inspiration trigger level
[Tslope]:	Time of pressure rising

6.6.4 V-SIMV

V-SIMV is volume-synchronized intermittent mandatory ventilation mode. It provides the minimum number of mandatory breaths based on the preset intermittent mandatory ventilation frequency. Mandatory ventilation mode is volume mode (V-A/C mode). If patient triggers within the trigger window, ventilator delivers mandatory volume control breath once. Mandatory volume control breath is also delivered once if it is not triggered at the end of trigger window. Spontaneous breathing or pressure support breathing is supported outside the trigger window. The duration of trigger window is 5s for adults and 1.5s for pediatrics and neonates. If the expiratory time is less than the duration of trigger window, the trigger window covers the expiratory time. The following figure shows typical waveforms in V-SIMV+PSV mode.

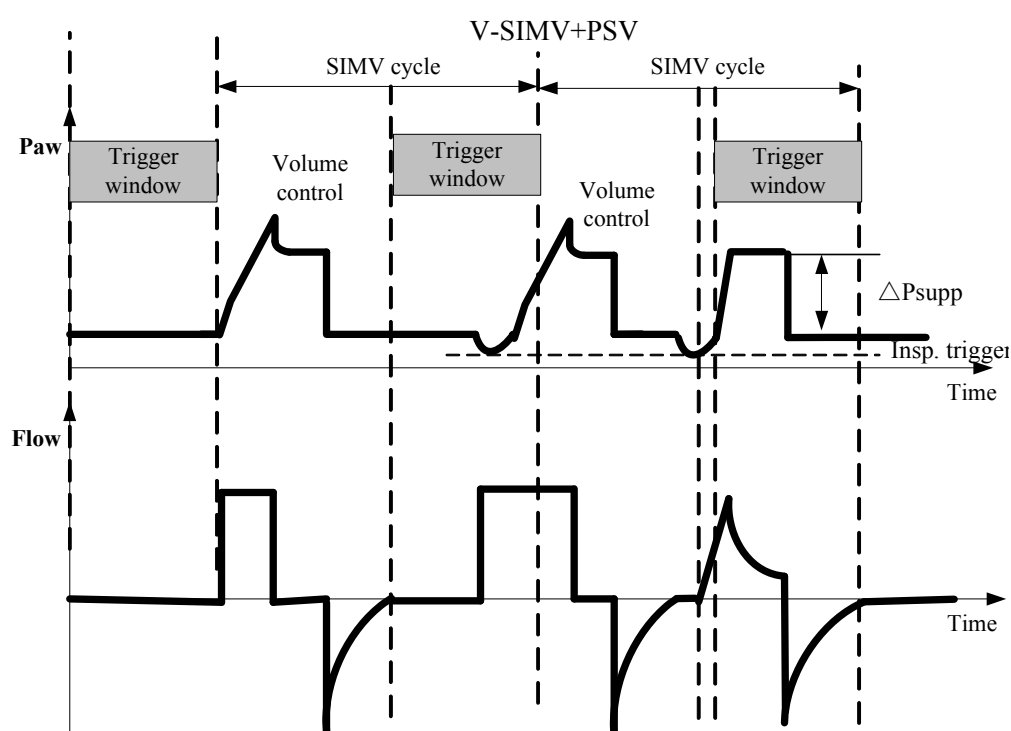

In V-SIMV mode, you need to set the following basic ventilation parameters:

[O ₂ %]:	Oxygen concentration
[TV]:	Tidal volume
[T _{insp}]:	Inspiration time
[f _{simv}]:	Mandatory breathing frequency
[T _{pause} (%)] or [Flow]:	Percent of inspiratory pause time or flow delivered to the patient during inspiration
[ΔP _{supp}]:	Pressure support level
[PEEP]:	Positive end-expiratory pressure
[F-Trig] or [P-Trig]:	Inspiration trigger level
[Exp%]:	Expiration trigger level
[T _{slope}]:	Time of pressure rising

[Apnea Vent]:	Switch for apnea ventilation
[TVapnea] or [ΔP_{apnea}]:	Tidal volume or inspiration pressure in apnea ventilation cycle
[fapnea]:	Frequency of apnea ventilation
[Apnea Tinsp]:	Inspiration time of apnea ventilation

6.6.5 P-SIMV

P-SIMV is pressure-synchronized intermittent mandatory ventilation mode. It provides the minimum number of mandatory breaths based on the preset intermittent mandatory ventilation frequency. Mandatory ventilation mode is pressure mode (P-A/C mode). If patient triggers within the trigger window, ventilator delivers mandatory pressure control breath once. Mandatory pressure control breath is also delivered once if it is not triggered at the end of trigger window. Spontaneous breathing or pressure support breathing is supported outside the trigger window. The duration of trigger window is 5s for adults and 1.5s for pediatrics and neonates. If the expiratory time is less than the duration of trigger window, the trigger window covers the expiratory time. The following figure shows typical waveforms in P-SIMV+PSV mode.

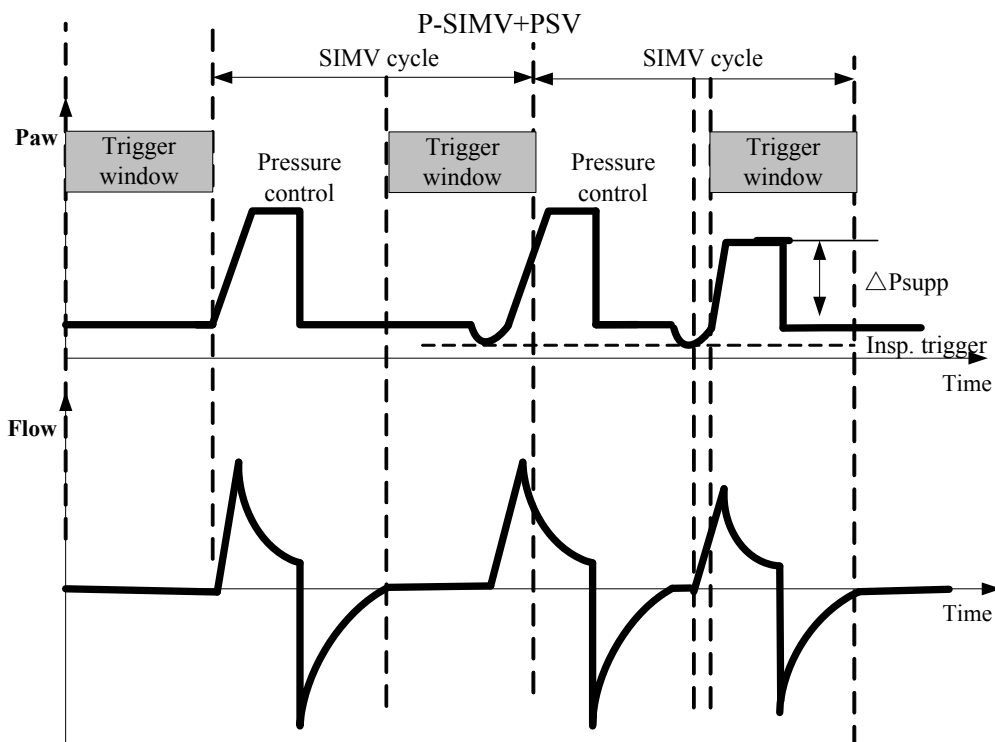

In P-SIMV mode, you need to set the following basic ventilation parameters:

[O ₂ %]:	Oxygen concentration
[ΔP_{insp}]:	Inspiratory pressure
[Tinsp]:	Inspiration time
[fsimv]:	Mandatory breathing frequency
[Tslope]:	Time of pressure rising
[PEEP]:	Positive end-expiratory pressure
[Exp%]:	Expiration trigger level

[ΔP_{supp}]:	Pressure support level
[F-Trig] or [P-Trig]:	Inspiration trigger level
[Apnea Vent]:	Switch for apnea ventilation
[TV _{apnea}] or [ΔP_{apnea}]:	Tidal volume or inspiration pressure in apnea ventilation cycle
[f _{apnea}]:	Frequency of apnea ventilation
[Apnea T _{insp}]:	Inspiration time of apnea ventilation

6.6.6 CPAP/PSV

PSV is pressure support ventilation mode. The system delivers a PSV when it detects that patient inspiratory effort reaches the preset inspiration trigger level. Time of pressure rising and pressure support level are set by the user. At the beginning of inspiratory phase, the patient's airway pressure rises to the preset pressure level within the preset time of pressure rising, and is held at this pressure level till patient inspiratory flow is detected to reach the expiration trigger level. In PSV, when the airway pressure is held at the preset pressure level, delivered gas flow decelerates, and varies with the resistance and compliance of the patient's lungs.

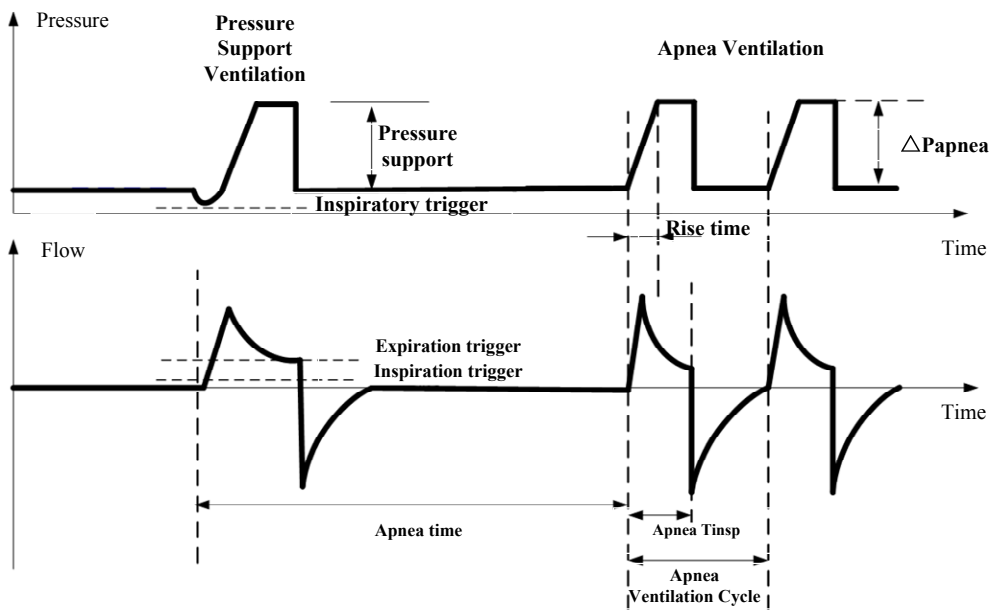

CPAP is continuous positive airway pressure ventilation mode. The airway pressure is held at the user-set positive pressure level throughout the ventilation cycle. The patient breathes spontaneously and determines his own breathing frequency, tidal volume, and breath time. The system starts apnea ventilation when it detects that the period of time in which patient does not perform continuous spontaneous breathing exceeds the preset apnea time.

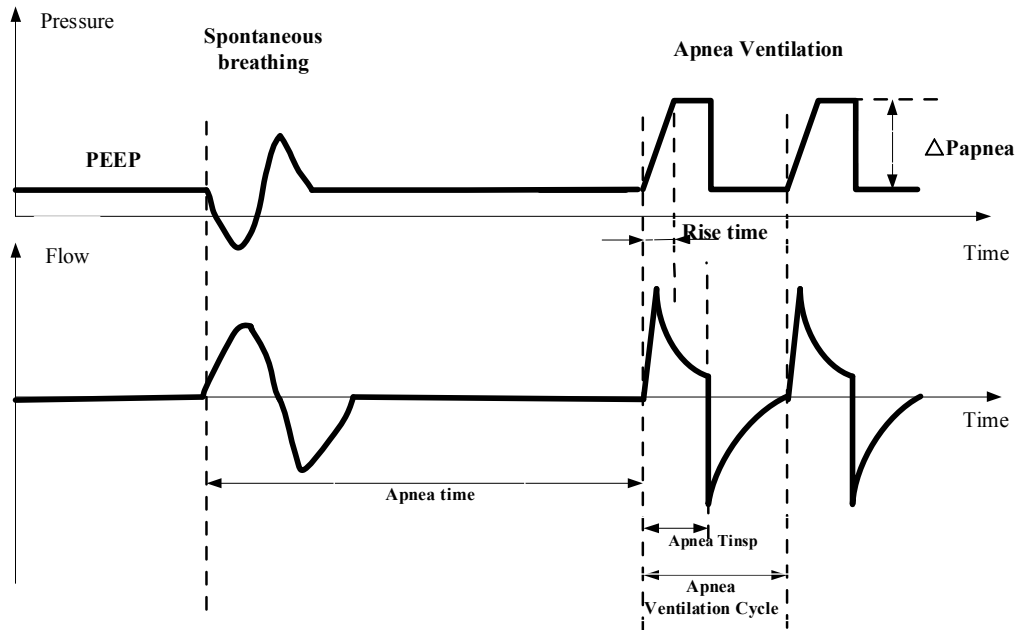

In CPAP/PSV mode, you need to set the following basic ventilation parameters in Invasive ventilation:

[O ₂ %]:	Oxygen concentration
[ΔP _{supp}]:	Pressure support level
[PEEP]:	Positive end-expiratory pressure
[F-Trig] or [P-Trig]:	Inspiration trigger level
[Exp%]:	Expiration trigger level
[Tslope]:	Time of pressure rising
[TV _{apnea}] or [ΔP _{apnea}]:	Tidal volume or inspiration pressure in apnea ventilation cycle
[f _{apnea}]:	Frequency of apnea ventilation
[Apnea Tinsp]:	Inspiration time of apnea ventilation

In CPAP/PSV mode, you need to set the following basic ventilation parameters in Non-Invasive ventilation (NIV):

[O ₂ %]:	Oxygen concentration
[ΔP _{supp}]:	Pressure support level
[PEEP]:	Positive end-expiratory pressure
[Ti max]:	Maximum time of inspiration
[F-Trig] or [P-Trig]:	Inspiration trigger level
[Exp%]:	Expiration trigger level
[Tslope]:	Time of pressure rising
[TV _{apnea}] or [ΔP _{apnea}]:	Tidal volume or inspiration pressure in apnea ventilation cycle
[f _{apnea}]:	Frequency of apnea ventilation
[Apnea T _{insp}]:	Inspiration time of apnea ventilation

6.6.7 PSV-S/T

PSV-S/T mode is called pressure support ventilation-spontaneous/timed ventilation mode, which means that the system will start pressure support ventilation (PSV) upon detection of patient's inspiration effort that reaches the preset inspiratory trigger level. Time of pressure rising and pressure support level are set by the user. At the beginning of the inspiratory phase, the patient's airway pressure increases to the preset pressure level within the preset time, and is held at this pressure level until the patient's inspiratory flow is detected to have reach the expiratory trigger level.

In the PSV-S/T ventilation mode, when the system detects that the patient doesn't trigger within the preset maximum breathing cycle (60s/breathing frequency), the system will start the Mandatory ventilation. The period of Mandatory ventilation is subject to [f] and [T_{insp}]. When the system detects that the patient triggers within the preset maximum breathing cycle (60s/breathing frequency), the system will start the pressure-supported ventilation.

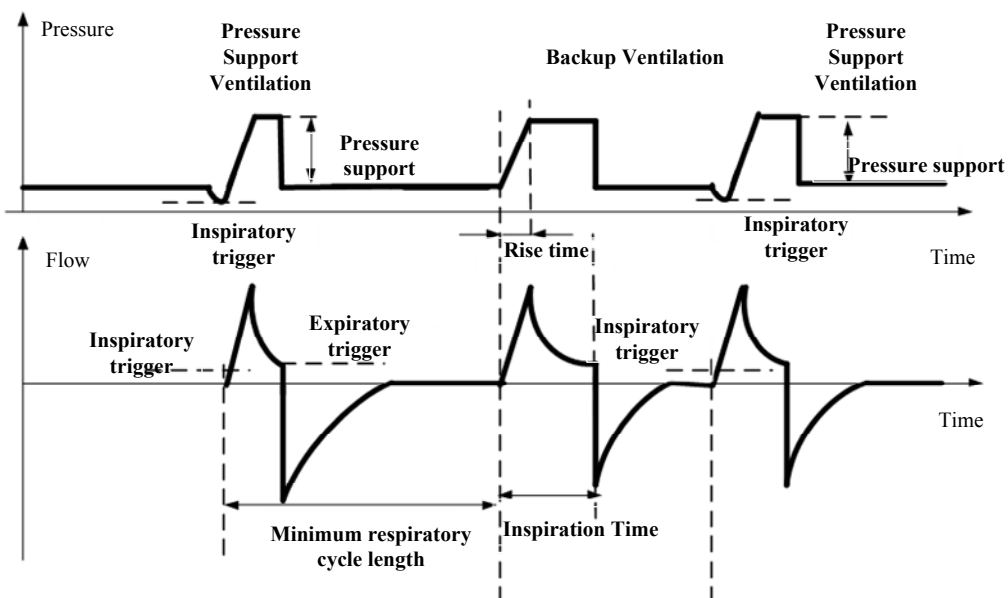

In PSV-S/T mode, you need to set the following basic ventilation parameters:

[O ₂ %]:	Oxygen concentration
[Δ P _{supp}]:	Pressure support level
[PEEP]:	Positive end-expiratory pressure
[F-Trig] or [P-Trig]:	Inspiration trigger level
[Exp%]:	Expiration trigger level
[Tslope]:	Time of pressure rising
[f]:	Frequency of mandatory ventilation
[T _{insp}]:	Inspiration time of mandatory ventilation
[T _{i max}]:	Maximum time of inspiratory phase (only applied to pressure-supported ventilation period)

6.6.8 PRVC

PRVC is pressure regulated volume control ventilation mode. It implements delivering set tidal volume by the way of pressure control ventilation. In PRVC, a relatively low pressure level is held as much as possible during the inspiratory phase, and the gas volume delivered is guaranteed to be equal to the preset tidal volume. P_{peak} will vary according to the tidal volume setting and the resistance and compliance of the patient's lungs. Pressure adjustment increase of the ventilator cannot exceed 10 cmH₂O for the first 3 cycles, and cannot exceed 3 cmH₂O for each of the following cycles. The maximum pressure cannot exceed the pressure alarm high limit-5 cmH₂O.

The first PRVC delivered is experimental ventilation mode. And the gas delivery pressure of the first cycle is 10 cmH₂O+PEEP for the purpose of calculating compliance and resistance of the system and patient's lungs, and calculating pressure level based on the patient's condition. This pressure level will then be used as a regulating object for tidal volume control in the following ventilation cycles.

The following figure shows typical waveforms in PRVC mode.

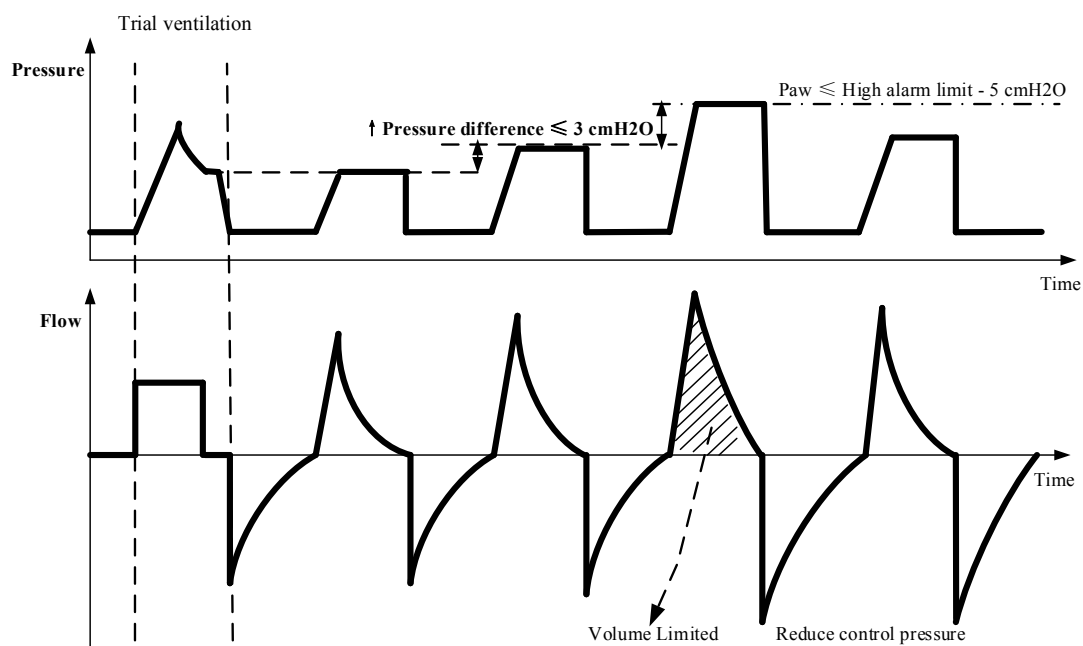

In PRVC mode, you need to set the following basic ventilation parameters:

[O ₂ %]:	Oxygen concentration
[TV]:	Tidal volume
[T _{insp}] or [I:E]:	Inspiration time or ratio of inspiratory time to expiratory time
[f]:	Breathing frequency
[PEEP]:	Positive end-expiratory pressure
[Assist]:	Switching trigger ON/OFF
[F-Trig] or [P-Trig]:	Inspiration trigger level
[Tslope]:	Time of pressure rising

6.6.9 PRVC-SIMV

PRVC-SIMV is pressure regulated volume control -synchronized intermittent mandatory ventilation mode. It provides the minimum number of mandatory breaths based on the preset intermittent mandatory ventilation frequency. The provided mechanical ventilation mode is volume mode (PRVC mode). If patient triggers within the trigger window, ventilator delivers mandatory volume control breath once. Mandatory PRVC breath is also delivered once if it is not triggered at the end of trigger window. Spontaneous breathing or pressure support breathing is supported outside the trigger window. The duration of trigger window is 5s for adults and 1.5s for pediatrics and neonates. If the expiratory time is less than the duration of trigger window, the trigger window covers the expiratory time. The following figure shows typical waveforms in PRVC -SIMV+PSV mode.

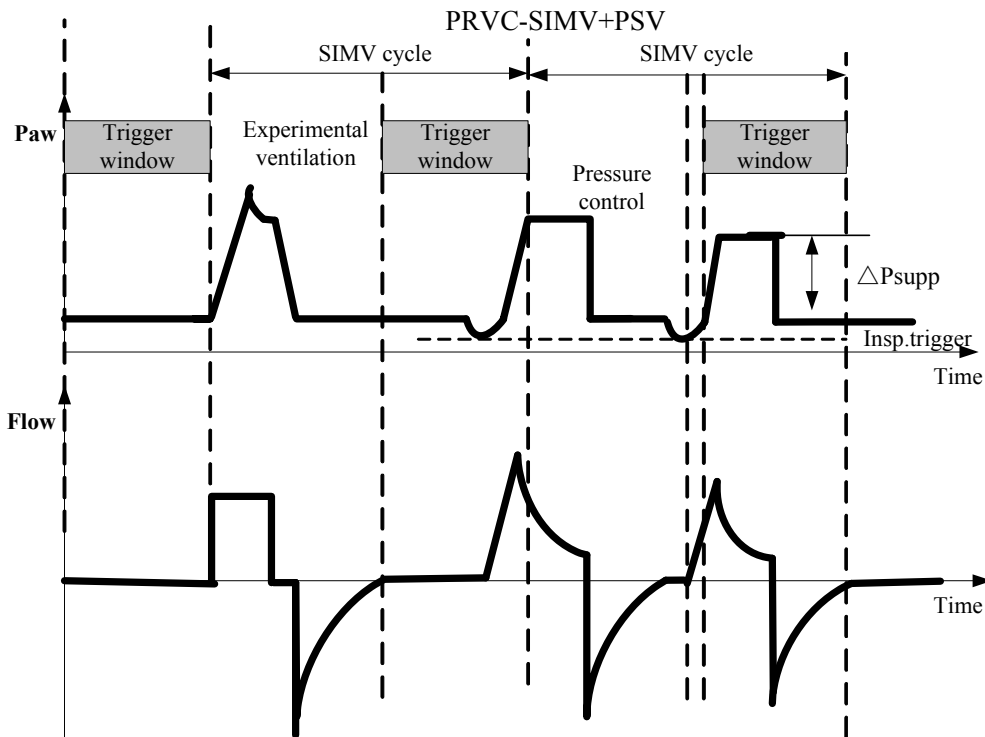

In PRVC-SIMV mode, you need to set the following basic ventilation parameters:

[O ₂ %]:	Oxygen concentration
[TV]:	Tidal volume
[T _{insp}]:	Inspiration time
[f _{simv}]:	Mandatory breathing frequency
[ΔP _{supp}]:	Pressure support level
[PEEP]:	Positive end-expiratory pressure
[F-Trig] or [P-Trig]:	Inspiration trigger level
[Exp%]:	Expiration trigger level
[Tslope]:	Time of pressure rising
[Apnea Vent]:	Switch for apnea ventilation
[TV _{apnea}] or [ΔP _{apnea}]:	Tidal volume or inspiration pressure in apnea ventilation cycle
[f _{apnea}]:	Frequency of apnea ventilation
[Apnea T _{insp}]:	Inspiration time of apnea ventilation

6.6.10 DuoLevel

DuoLevel is dual level positive airway pressure ventilation mode. In DuoLevel mode, the ventilator delivers positive airway pressure at two pressure levels alternatively during mechanical ventilation or spontaneous breathing. The patient can breathe spontaneously at either pressure level. During the low pressure phase, pressure support can be set. Trigger window is available during both high and low pressure phases, during which triggered transition to the other pressure level occurs. The trigger window during the low pressure phase is the later 5 seconds of low pressure time (T_{low}), while the trigger window during the high pressure phase is the later 1/4 of high pressure time (T_{high}). Within the trigger window of low pressure phase, inspiratory trigger transforms to high pressure gas delivery. Within the trigger window of high pressure phase, expiratory trigger transforms to low pressure gas delivery. The duration of trigger window is 5s for adults and 1.5s for pediatrics and neonates. If the expiratory time is less than the duration of trigger window, the trigger window covers the expiratory time. The following figure shows typical waveforms in DuoLevel mode.

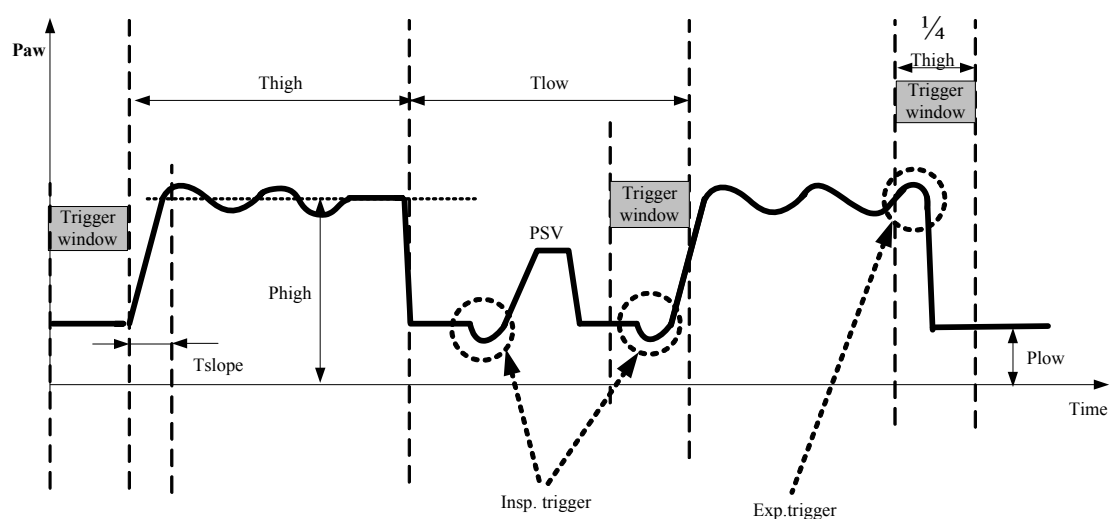

In DuoLevel mode, you need to set the following basic ventilation parameters:

[O ₂ %]:	Oxygen concentration
[Phigh]:	High pressure
[Thigh] or [f]:	Time of high pressure or breathing frequency
[Plow]:	Low pressure
[Tlow], [Tinsp] or [I:E]:	Time of low pressure, inspiration time or ratio of inspiratory time to expiratory time or inspiratory/expiratory ratio
[ΔPsupp]:	Pressure support level
[F-Trig] or [P-Trig]:	Inspiration trigger level
[Exp%]:	Expiration trigger level
[Tslope]:	Time of pressure rising
[TVapnea] or [ΔPapnea]:	Tidal volume or inspiration pressure in apnea ventilation cycle
[fapnea]:	Frequency of apnea ventilation
[Apnea Tinsp]:	Inspiration time of apnea ventilation

6.6.11 APRV

APRV is airway pressure release ventilation mode. It can be seen as periodical, short period airway pressure release in CPAP mode.

The following figure shows typical waveforms in APRV mode.

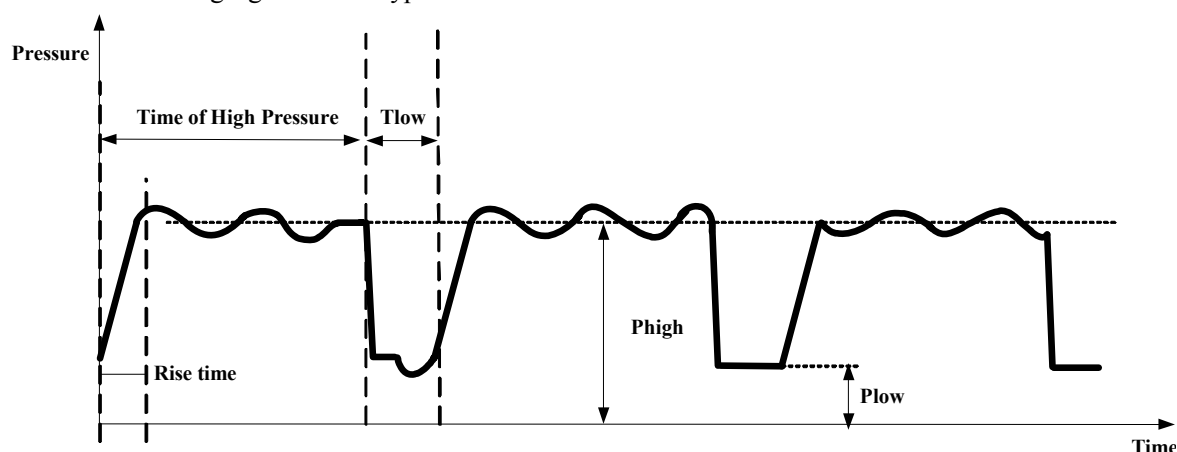

In APRV mode, you need to set the following ventilation parameters:

[O ₂ %]:	Oxygen concentration
[Phigh]:	High pressure
[Thigh]:	Time of high pressure
[Plow]:	Low pressure
[Tlow]:	Time of low pressure
[Tslope]:	Time of pressure rising
[TVapnea] or [ΔPapnea]:	Tidal volume or inspiration pressure in apnea ventilation cycle
[fapnea]:	Frequency of apnea ventilation
[Apnea Tinsp]:	Inspiration time of apnea ventilation
[F-Trig] or [P-Trig]:	Inspiration trigger level

6.6.12 VS

VS refers to volume support ventilation, which means that the system will initiate volume support ventilation upon detection of the patient's inspiration effort reaching the preset inspiratory trigger level. This mode adjusts the pressure support levels depending on the patient's lung resistance, and compliance and inspiration efforts, to ensure provision of preset target tidal volume for the patient. In this mode, the duration of inspiratory and expiratory phases are controlled by the patients themselves. The system starts apnea ventilation when it detects that the period of time in which patient does not perform continuous effective inspiratory trigger exceeds the preset apnea time.

VS primary ventilation is the experimental ventilation mode, the gas delivery pressure of the first cycle is $10 \text{ cmH}_2\text{O} + \text{PEEP}$ for the purpose of calculating compliance and resistance of the system and patient's lungs, and calculating pressure support level based on the patient's condition. This pressure support level will then be used to regulate tidal volume control in the following ventilation cycles. Pressure increase of the ventilator cannot exceed $10 \text{ cmH}_2\text{O}$ for the first 3 cycles, and $3 \text{ cmH}_2\text{O}$ for each of the following cycles. The maximum pressure cannot exceed the pressure alarm high limit - $5 \text{ cmH}_2\text{O}$. The first PRVC delivered is experimental ventilation mode.

The following figure shows typical waveforms in VS mode.

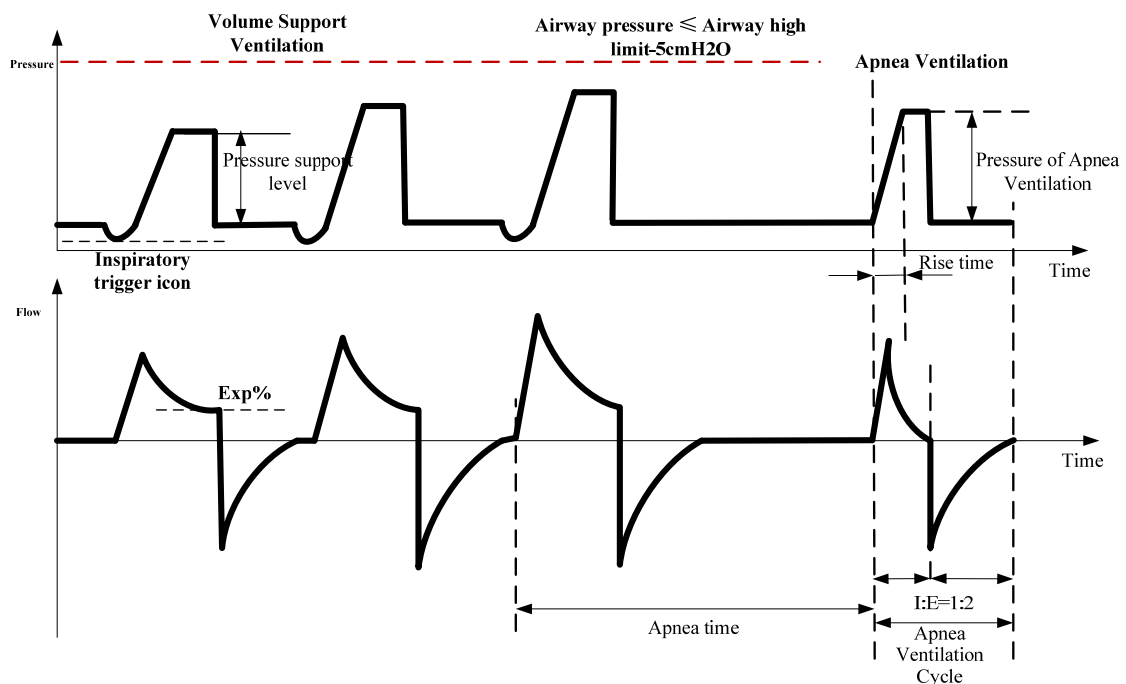

In VS mode, you need to set the following basic ventilation parameters:

[O ₂ %]:	Oxygen concentration
[TV]:	Tidal volume
[PEEP]:	Positive end-expiratory pressure
[F-Trig] or [P-Trig]:	Inspiration trigger level
[Exp%]:	Expiration trigger level
[Tslope]:	Time of pressure rising
[TVapnea] or [ΔPapnea]:	Tidal volume or inspiration pressure in apnea ventilation cycle
[fapnea]:	Frequency of apnea ventilation
[Apnea Tinsp]:	Inspiration time of apnea ventilation

6.6.13 AMV

AMV refers to adaptive minute ventilation, which is a ventilation mode that adjusts the patient's ventilation parameters based on minimum work of breathing (WOB). The user only needs to enter the patient's ideal body weight (IBW) and target minute ventilation volume percentage, the ventilator will calculate the tidal volume and breathing frequency with the minimum WOB using the Otis equation. It will also adjust the I:E ratio depending on the measured lung time constant. AMV is only suitable for adult and pediatric ventilation.

Otis equation:

$$f = \frac{\sqrt{1 + 2a \cdot RC_{exp} \cdot \frac{MV - f \cdot V_d}{V_d}} - 1}{a \cdot RC_{exp}}$$

Where, f is the breathing frequency under minimum WOB, MV is target minute volume, V_d is volume of patient's physiological dead space, RC_{exp} refers to time constant of lung, a is coefficient of waveform, For sine-wave, a=2π²/60.

Target minute volume is calculated by the following formula:

Target minute volume MV= Minute volume %×f_{default}×TV/IBW×IBW/1000

Where, TV/IBW refers to ideal body weight tide volume. IBW is ideal body weight. f_{default} is a group of defaults related to IBW, which values are listed as below:

IBW (kg)	f _{default} (/min)
[3, 9)	35
[9, 13)	30
[13, 17)	25
[17, 23)	20
[23, 29)	15
[29, 36)	14
[36, 200)	12

The first three cycles of AMV is PCV experimental ventilation to calculate patient's lung resistance and compliance. Initial ventilation parameters are:

Adult experimental ventilation cycle setting parameters

IBW (kg)	P _{insp} (cmH ₂ O)	T _{insp} (s)	f(/min)
10-29	15	1	15
30-39	15	1	14
40-59	15	1	12
60-89	15	1	10
90-99	18	1.5	10
≥100	20	1.5	10

Pediatric experimental ventilation cycle setting parameters

IBW (kg)	P _{insp} (cmH ₂ O)	T _{insp} (s)	f(/min)
3-5	15	0.4	30
6-8	15	0.6	25
9-11	15	0.6	20
12-14	15	0.7	20
15-20	15	0.8	20
21-23	15	0.9	15
24-29	15	1	15
30-35	15	1	14

After three experimental ventilation, enter the automatic adjustment stage. Based on the principle of minimum WOB, ensure that the actual minute volume is as close as possible to the preset minute volume value. Mandatory ventilation is administered if the patient has no spontaneous breathing. Support ventilation is administered if the patient restores spontaneous breathing.

The following figure shows typical waveforms in AMV mode.

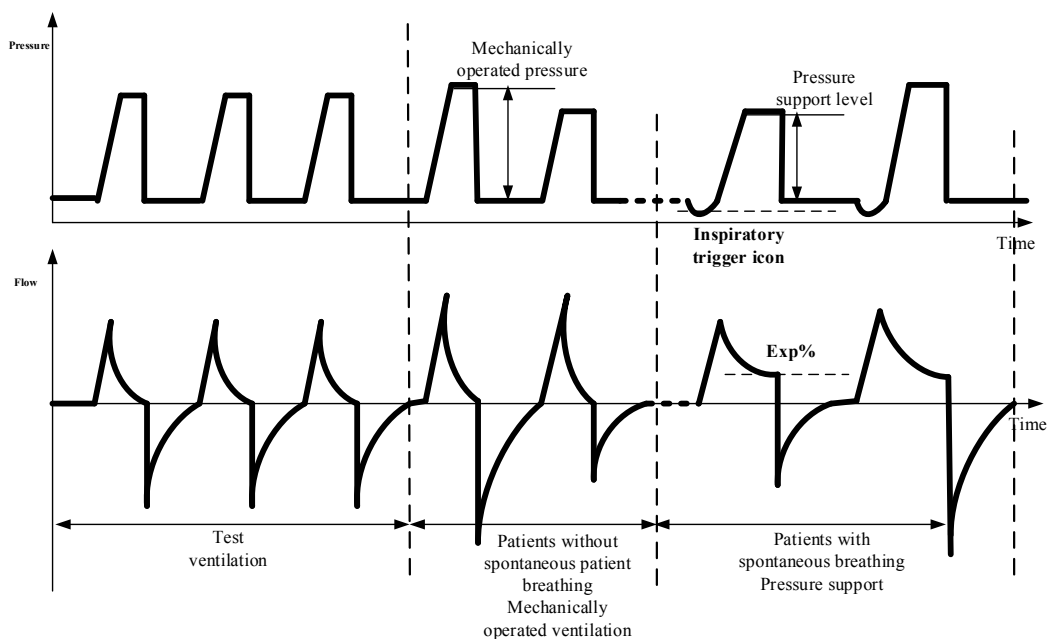

In AMV mode, you need to set the following basic ventilation parameters:

[O ₂ %]:	Oxygen concentration
[MV%]:	Percentage of minute volume
[PEEP]:	Positive end-expiratory pressure
[F-Trig] or [P-Trig]:	Inspiration trigger level
[Exp%]:	Expiration trigger level
[Tslope]:	Time of pressure rising

6.6.14 CPRV

CPRV refers to cardiopulmonary resuscitation ventilation, which is a ventilation mode applied during the process of cardiopulmonary resuscitation (CPR), and can be activated quickly during CPR to provide the patient with mechanical ventilation in a timely fashion while avoiding harm to the patient caused by frequent trigger and over-ventilation during CPR.

CPRV mode is based on V-A/C mode, with the inspiratory trigger being turned off, the fraction of inspired oxygen concentration (FiO₂) default value at 100%, I:E ratio default value at 1:2, and PEEP default value at 0 cmH₂O. The user can initiate ventilation immediately after completion of patient type and IBW settings, and the ventilator will deliver volume-controlled ventilation at the preset tidal volume and frequency. However, the user may also set the tidal volume and breathing frequency. During the expiration phase of ventilation, e-ITD (Electronic impedance threshold device) prevents unnecessary airflow from entering the chest during the recoil phase of CPR, enhances negative pressure in the chest.

The following figure shows typical waveforms in CPRV mode.

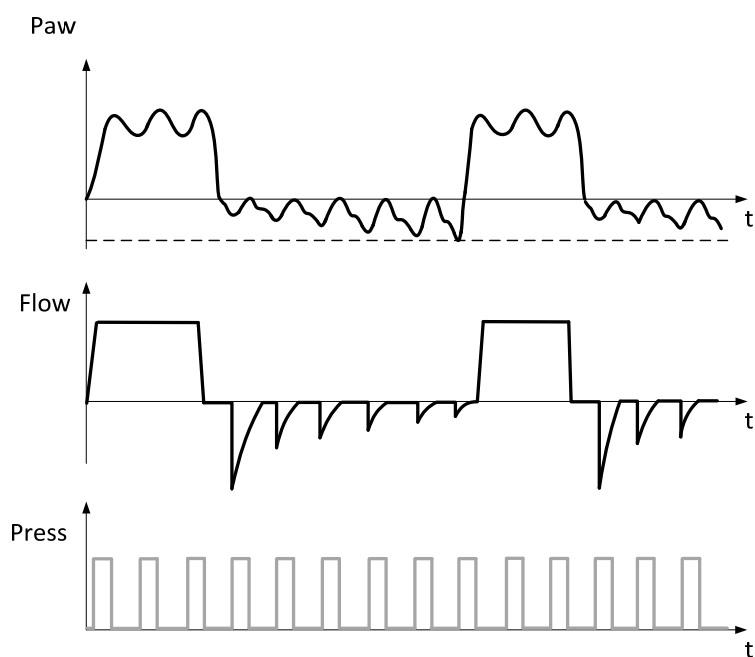

In CPRV mode, you need to set the following basic ventilation parameters:

[TV]:	Tidal volume
[f]:	Breathing frequency
[O ₂ %]:	Oxygen concentration
[T _{insp}] or [I:E]:	Inspiration time or ratio of inspiratory time to expiratory time
[PEEP]:	Positive end-expiratory pressure
[T _{pause (%)}] or [Flow]:	Percentage of inspiratory pause time or flow delivered to the patient in the inspiratory phase
[Compression Prompt]:	Pressing prompt switch
[Comp. f]:	Pressing frequency
[EtCO ₂ reference line]:	The referential line of high and low alarm limit of expiratory EtCO ₂
[e-ITD]:	Electronic impedance threshold device
[Neg.Plimit]:	The low limit of the negative pressure

6.6.15 nCPAP

nCPAP is nasal continuous positive airway pressure ventilation mode. The nCPAP mode is to be used only with neonatal patients and is only available in NIV mode. The airway pressure is held at the user-set positive pressure level throughout the ventilation cycle. The patient breathes spontaneously and determines his own breathing frequency, tidal volume, and breath time.

The following figure shows typical waveforms in nCPAP mode.

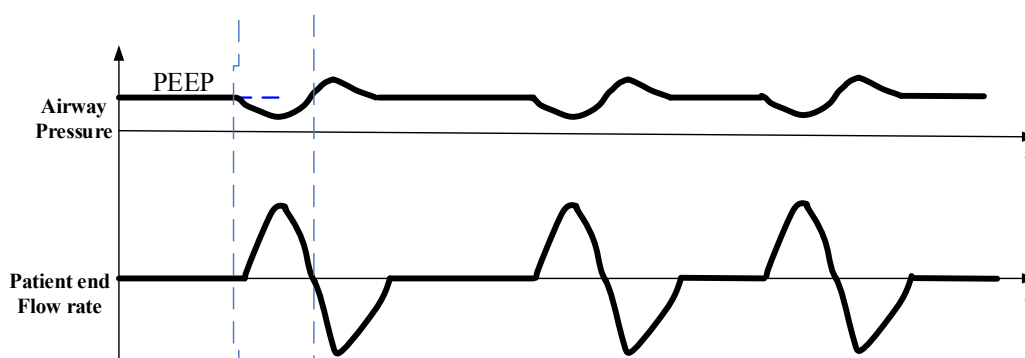

In nCPAP mode, you need to set the following basic ventilation parameters:

[O ₂ %]:	Oxygen concentration
[PEEP]:	Positive end-expiratory pressure
[Δ P _{manInsp}]:	Inspiratory pressure of the manual respiratory cycle
[T _{manInsp}]:	Inspiratory time of the manual respiratory cycle

6.6.16 Apnea Ventilation

Apnea ventilation mode is a backup ventilation mode initiated when the ventilator detects patient apnea in CPAP/PSV, VS, V-SIMV, P-SIMV, PRVC-SIMV, DuoLevel and APRV modes. Apnea ventilation can exit only under the following circumstances: patient's spontaneous breathing has been detected continuously twice, ventilation mode is switched over, or apnea ventilation is switched off (in SIMV modes).

This ventilator provides two types of apnea ventilation mode: volume-controlled apnea ventilation and pressure-controlled apnea ventilation. Both volume-controlled apnea ventilation and pressure-controlled apnea ventilation are supported in case of invasive ventilation. Only pressure-controlled apnea ventilation is supported in case of non-invasive ventilation.

Volume-controlled apnea ventilation means that tidal volume, breathing frequency, and inspiration time in the apnea ventilation cycle can be set in the mode supporting apnea ventilation. After entering apnea ventilation, the ventilator executes V-A/C mode ventilation with the set tidal volume, breathing frequency, and inspiration time in the apnea ventilation cycle (other parameters settings values are unchanged).

Pressure-controlled apnea ventilation means that inspiration pressure, breathing frequency, and inspiration time in the apnea ventilation cycle can be set in the mode supporting apnea ventilation. After entering apnea ventilation, the ventilator executes P-A/C ventilation with the set inspiration pressure, breathing frequency, and inspiration time in the apnea ventilation cycle (other parameter's setting values are unchanged).

CAUTION

- You are suggested to initiate apnea ventilation in SIMV mode.
-

6.7 Other Ventilation Settings

6.7.1 Sigh

Sigh function can prevent pulmonary collapse, by aiding the collapsed pulmonary alveoli to reopen.

Pressure sigh function can be activated in V-A/C, P-A/C, PRCV, V-SIMV, P-SIMV, PRVC-SIMV and AMV modes. After activation of pressure sigh function, PEEP (positive end-expiratory pressure) will increase the preset [Δ int.PEEP] intermittently. [**Interval**] refers to the time interval between two sigh stages. [**Cycles sigh**] refers to the cycles of sigh during each sigh stage.

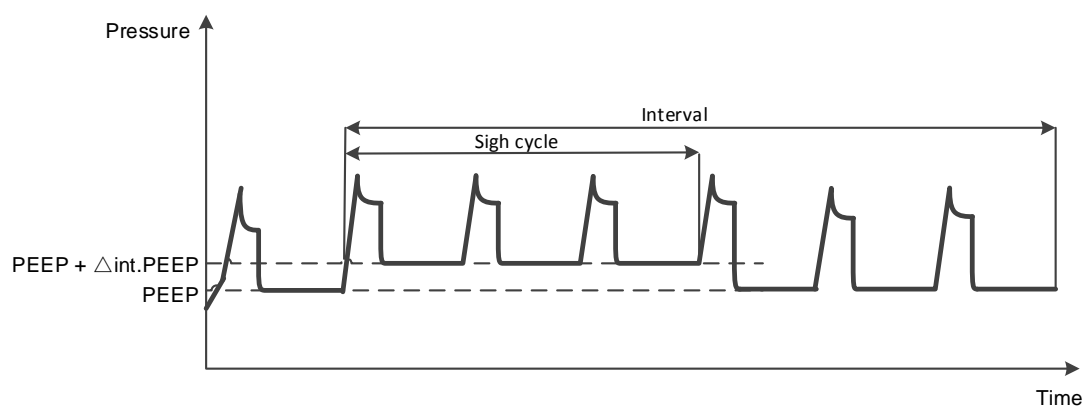

Set the following sigh function parameters as required:

[Sigh]:	Switch for turning on sigh function
[Interval]:	Time interval between two of sigh stages
[Cycles sigh]:	sigh cycles
[Δint.PEEP]:	PEEP increase in sigh cycle

6.7.2 Leak Compensation

The leakage from the breathing circuit and mask may cause that the gas volume delivered to the patient's lung is lower than the setting value. The leakage also may cause the false inspiratory trigger or difficult switching between inspiratory and expiratory.

The ventilator provides automatic leakage compensation function. The ventilator updates the amount of leakage at the end of each breathing cycle according to the difference between the inspired tidal volume and expired tidal volume, and the amount of leakage can be used for the calculation of real-time leakage flow in next breathing cycle.

During the expiration stage, the base flow will be regulated automatically to compensate the leakage and maintain the PEEP valve. In order to prevent the false inspiratory trigger, flow trigger working mechanism is based on the compensated flow. Maximum leakage compensation flow is 65 L/min for adult patients, 45 L/min for pediatric patients and 15 L/min for neonate patients respectively.

In volume control ventilation mode, the delivered gas volume is the sum of the setting TV and the amount of leakage. The leakage compensation in invasive ventilation: the upper limit of the leakage compensation is 80% of the setting TV.

In pressure control ventilation mode, the ventilator regulates the flow automatically to compensate the leakage in order to maintain the inspiratory pressure. But the upper limit of the compensation is restricted by the TV high limit. The ventilator will not increase the flow and display the **[Volume Limited]** alarm message when the flow exceeds the TV high limit (If you want to reach the maximum leakage compensation, you can set the TV high limit to off).

Automatic leakage compensation

The ventilator determines the difference between the delivered flow on the inspiration side and the measured flow on the expiration side.

This difference provides a measure of the amount of leakage and is displayed by the ventilator as the leakage minute volume MV_{leak}.

The ventilator can compensate for this leakage in volume controlled ventilation.

Example: Tidal volume setting TV = 600 mL, 10 % leakage in tube.

Without Leakage compensation

The ventilator delivers 600 mL. This is indicated as the inspiratory tidal volume TV_i. 60 mL escape as leakage during inspiration, and 540 mL reach the lung.

540 mL are expired, and 40 mL again escape as leakage. A tidal volume of 500 mL is measured on the expiration side and indicated as TV_e.

With a ventilation rate of 10 strokes per minute, a minute volume of 6.0 L/min is delivered on the inspiration side and a minute volume of 5.0 L/min is measured on the expiration side. The lung is ventilated with an MV of 5.4 L/min.

Without leakage compensation, the set TV determines the volume delivered by the ventilator.

With Leakage compensation

With automatic leakage compensation, the ventilator delivers 660 mL on the basis of the measured leakage minute volume, instead of the 600 mL set.

600 mL enter the lung and the displayed inspiratory tidal volume TV is 600 mL.

The volume of 500 mL measured on the expiration side is displayed without compensation, even when leakage compensation is activated.

The minute volume measured on the expiration side is 5.0 L/min and is also uncompensated.

If this were not so, the alarm for a low minute volume could be inhibited by the expiratory leakage compensation. The ventilator must always emit an alarm if the minute volume is too low.

With leakage compensation, the set TV determines the volume to be delivered to the patient.

This example has been simplified:

In fact, the calculated leakage correction takes into account the pressures in the hose system.

A higher percentage volume is lost on the inspiration side than on the expiration side because the pressure during inspiration is higher.

The displayed leakage minute volume MVleak is based on the mean pressure Pmean.

The leakage minute volume MVLeak also takes the inspiratory leaks into account. The sum of the minute volume MV + the leakage minute volume MVLeak is consequently greater than the inspiratory minute volume delivered to the patient.

Unlimited volume compensation is inappropriate.

The ventilator compensates for losses of up to 100 % of the set tidal volume TV.

Due to technical tolerances, a small leakage minute volume may be displayed even if the hose system is leakproof.

6.7.3 Automatic Tube Resistance Compensation (ATRC)

ATRC stands for the function of automatic tube resistance compensation. By selecting appropriate endotracheal (ET) tube or tracheostomy (Trach) tube of different diameters for the user, the ventilator can adjust gas delivery pressure automatically, so that the pressure at the end of the tube is consistent with the ventilator's pressure setting value as much as possible.

1. Select the ventilation type icon  and then select the [ATRC] tab in the opened menu to enter the ATRC interface.
2. Set ATRC Type, Tube I.D., Compensate, and Expiration on the accessed screen.
 - [ATRC Type]: Disable ATRC, ET Tube and Trach Tube.
 - [Tube I.D.]: ET tube diameter.
 - [Compensate]: Percentage of ATRC.
 - [Expiration] : Enable or disable compensation during exhalation.
3. Select [Ok] for the system to initiate ATRC. After ATRC has been enabled, if you enter the ATRC interface and then select [Disable ATRC], the system will terminate ATRC immediately in the ventilation.

When ATRC is enabled, P_{trach} waveform is displayed with the P_{aw} waveform. As shown in the figure below:

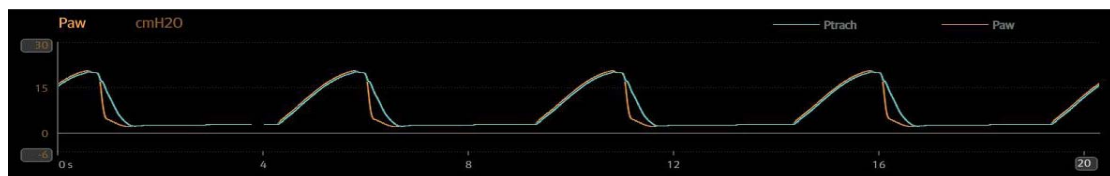

WARNING

- ATRC may induce autotriggering. If autotriggering occurs, first check the patient, breathing circuit, and other possible causes.

NOTE

- Incorrect tube type or ID setting can endanger the patient. Make sure to set them properly.

6.7.4 IntelliCycle

IntelliCycle intelligent synchronous technology means that the user can set [Exp%] to [Auto] in CPAP/PSV, V-SIMV, P-SIMV, PRVC-SIMV, DuoLevel, VS and AMV modes and ventilator will adjust [Exp%] dynamically by adaptive algorithm through extracting and analysing the waveform characteristics. This way, ventilator monitors and adapts [Exp%] according to patient condition and needs automatically, and ends inspiration with more synchrony.

6.8 Alarm settings

Select the [Alarm] key on the main screen to set the ventilation alarm limit and module alarm limit in the opened menu. In addition, you can also set alarm volume and view the most recent alarms. Please see Chapter 12, “Alarms” for details.

6.9 Start Ventilation

WARNING

- **Before using the ventilator on the patient, check that the oxygen concentration in the delivered gas is consistent with the setting value.**
 - **Adopt manual ventilation immediately if the ventilator malfunctions and cannot continue ventilating the patient.**
-

Select [Start Ventilation] key in Standby status, and the system begins to ventilate the patient according to your settings.

6.10 Ventilation Parameters

WARNING

- As required by the relevant rules and regulations, oxygen concentration should be monitored when the equipment is used on the patient. If your ventilator is not configured with such monitoring function or this function is switched off, use a monitor which complies with ISO 80601-2-55 for oxygen concentration monitoring.
-

NOTE

- All the parameter values are calculated based on the real-time flow and pressure waveform data. For real-time flow and pressure data, low pass filter is adopted at original sampling rate of 1kHz and cutoff frequency of 20Hz.
 - Tidal volume, minute volume displayed on the ventilator and related calculation parameters are in the BTPS condition.
-

Setting parameter	Description
TV	The gas volume the patient inspires or expires each time during resting breathing.
Flow	Flow delivered to the patient during the inspiratory phase
O ₂ %	The volume percentage of oxygen in the mixed gas delivered to the patient.
I:E	The ratio between the inspiratory and expiratory time.
PEEP	Positive end-expiratory pressure.
Phigh	Phigh is the high pressure level at which the patient can spontaneously breathe and is an absolute value.
ΔP _{insp}	It is a relative value of the pressure, relative to PEEP.
Plow	Plow is the low pressure level at which the patient can breathe spontaneously.
ΔP _{supp}	Pressure support level in pressure control mode. It is a relative value relative to PEEP or Plow.
Tslope	Controls pressure rise slope in pressure mode.
T _{pause} (%)	Percent of gas delivery pause time in inspiratory time within the inspiratory phase.
MV%	Used for calculating the patient's target minute volume Target minute volume is equal to ideal minute volume * minute volume%
f	The number of mechanically controlled breaths delivered to the patient in one minute.
fsimv	Mandatory breathing frequency set in SIMV mode.

Thigh	Thigh is the time that the ventilator will hold the high pressure level.
Tlow	Tlow is the time that the ventilator will hold the low pressure level.
Tinsp	Inspiration Time in one breathing cycle.
Ti max	The maximum time in the inspiratory phase
F-Trig/P-Trig	<p>Pressure trigger and flow trigger included. When the trigger level is detected, the ventilator starts to enter the inspiratory phase. When F-Trig is active, at the late stage of expiration the ventilator delivers a base flow from the inspiratory limb to the expiratory limb. The base flow is essential for flow trigger.</p> <p>In non-invasive ventilation, the ventilator adjusts base flow from 0 L/min to maximum flow automatically to maintain PEEP and establish baseline for patient triggering. Maximum flow is 65 L/min for adult patients, 45 L/min for pediatric patients and 15 L/min for neonate patients respectively.</p> <p>In invasive ventilation, the ventilator adjusts base flow from 3 L/min to maximum flow automatically to maintain PEEP and establish baseline for patient triggering. Maximum flow is 20 L/min.</p>
Exp%	Inspiratory termination level. The ventilator is switched to the expiratory phase when the inspiratory flow drops to peak flow*Exp%.
Assist	Used to turn on or off assist trigger. When assist trigger is on, the patient is allowed to trigger mechanical ventilation at the end of expiration.
Apnea Vent	Turn on or turn off apnea ventilation function.
Δ Papnea	It is inspiration pressure in apnea ventilation when pressure mode is selected for apnea ventilation. It is a relative value relative to PEEP or P _{low} .
fapnea	Breathing frequency set in apnea ventilation mode.
TVapnea	It is delivered tidal volume in apnea ventilation when volume mode is selected for apnea ventilation.
Apnea Tinsp	Inspiration time set in apnea ventilation mode.
Δ PmanInsp	Pressure value relative to PEEP or low pressure level in the inspiratory phase of manually-triggered mandatory ventilation.
TmanInsp	Duration of the inspiratory phase during manually-triggered mandatory ventilation.
Sigh	Turn on or turn off sigh function.
Interval	It is the setting value of time interval between two groups of sigh ventilation.
Cycles Sigh	It is the setting value of number of cycles of every group of sigh ventilation.
Δ int.PEEP	It is intermittent PEEP augmentation, added during the sigh cycle.
Disable ATRC	Turn on or turn off ATRC function.
ET Tube	Initiate ATRC function for ET tube.
Trach Tube	Initiate ATRC function for Trach tube.
Tube I.D.	It refers to the diameter of tracheal or ET tube.
Compensate	It refers to proportion of ATRC compensation.
Expiration	Turn on or turn off ATRC function during the expiratory phase.
Patient size	Choose between adult, pediatric and neonate.
IBW	Used for calculating the patient's ideal minute volume.

Compression Prompt	Compression prompt switch.
Comp. f	The number of compression in one minute.
e-ITD	Turn on or turn off the electronic impedance threshold device.
Neg.Plimit	When the electronic impedance threshold device is turned on, make sure the maximum negative pressure is not lower than this setting value.
Monitored parameter	Description
Ppeak	The maximum pressure value in one breathing cycle.
Pplat	The airway pressure during inspiratory pause.
Pmean	The mean pressure value in one breathing cycle.
PEEP	Positive end-expiratory pressure.
TVi	The inspired tidal volume in one cycle.
TVe	The expired tidal volume in one cycle.
TVe spn	The spontaneous expired tidal volume in one cycle.
TVe/IBW	Delivered tidal volume per ideal body weight.
MVe	The accumulated expired tidal volume in one minute.
MVi	The inspiratory tidal volume accumulated in one minute.
MVspn	The accumulated spontaneous expired tidal volume in one minute.
MVleak	The accumulated leakage (inspiratory volume minus expiratory volume) in one minute.
Leak%	The percentage of gas leakage volume in total volume of the ventilator.
PtpI	Transpulmonary pressure at the end of inspiratory phase.
PtpE	Transpulmonary pressure at the end of expiratory phase.
ΔPtp	$\Delta Ptp = PtpI - PtpE$.
PesI	Oesophageal pressure at the end of inspiratory phase.
PesE	Oesophageal pressure at the end of expiratory phase.
ΔPes	Wobble value of oesophageal pressure at the end of inspiratory phase.
Paux2I	Auxiliary pressure 2 at the end of inspiratory phase.
Paux2E	Auxiliary pressure 2 at the end of expiratory phase.
PTPes	Oesophageal pressure time product of 1 breath.
PTPes/min	The accumulation of PTPes in one minute.
I:E	Ratio of inspiration time to expiration time in one cycle
Tinsp	Duration of the inspiratory phase
ftotal	The accumulated number of breaths in one minute.
fmand	The accumulated number of mandatory breaths in one minute.
fspn	The accumulated number of spontaneous breaths in one minute.
Ri	Inspiratory resistance the gas encounters when it flows inside the respiratory tract during respiration.
Re	Expiratory resistance the gas encounters when it flows inside the respiratory tract during respiration.
Cstat	Static compliance - easiness of patient's lungs being filled during mechanically assisted breathing. It is calculated in case of breathing paused

	and inspiration hold.
Cdyn	Dynamic compliance - easiness of patient's lungs being filled during mechanically assisted breathing. It is calculated during the inspiratory phase.
RSBI	Rapid shallow breathing index - quotient between fspn and TVe spn (measured in liters).
WOB	The total of WOBvent and WOBpat in one minute.
WOBpat	Work of breathing by the patient in one minute.
WOBvent	Work of breathing provided by the ventilator in one minute.
WOBimp	Work of breathing done by the patient to overcome suction valve, tubing and humidifier during spontaneous breathing.
RCexp	Patient's expiratory time constant – resistance multiplied with compliance.
PIF	Patient's maximum inspiratory flow in the inspiratory phase.
PEF	Patient's maximum expiratory flow in the expiratory phase.
EEF	Patient flow rate at the end of expiratory phase
C20/C	Ratio of the last 20% compliance in the inspiratory phase to the total compliance in the inspiratory phase.
NIF	Patient's maximum inspiratory negative occlusion pressure.
P0.1	The occlusion pressure drop in the first 100 ms when the patient starts spontaneous breathing.
PEEPi	Intrinsic PEEP (The PEEPi value displayed has already included PEEP value and is the actual airway pressure).
Vtrap	The volume of trapped gas in the lungs.
FiO ₂	The percentage of oxygen in the patient's inspired gas.
EtCO ₂	The concentration of CO ₂ measured at the end of expiration.
VDaw	Airway dead space.
VDaw/TVe	Ratio of airway dead space to tidal volume.
Vtalv	Alveolar tidal ventilation.
MValv	Alveolar minute ventilation.
slopeCO ₂	CO ₂ rising slope.
VeCO ₂	Exhaled CO ₂ volume.
ViCO ₂	Inspired CO ₂ volume.
VDalv	Alveolar dead space
VDphy	Physiological dead space
VDphy/TVe	Ratio of physiological dead space to tidal volume.
OI	Oxygenation index
P/F	Ratio of partial oxygen pressure to FiO ₂ .
SpO ₂	Oxygen saturation (SpO ₂)
PR	Pulse frequency
PI	Perfusion index
VCO ₂	Volume of carbon dioxide in a single breath
VO ₂	Oxygen consumption in a single breath
MVCO ₂	Minute volume of carbon dioxide
MVO ₂	Minute volume of oxygen

6.11 Enter Standby Status



Press the [Standby] key to enter the Standby interface after confirmation.

WARNING

- To prevent possible patient injury due to lack of ventilatory support, secure alternative ventilation for the patient before entering the Standby status. You must confirm that no patient is attached before entering Standby status.
 - To prevent possible patient injury or damage to breathing circuit from overheated gas, turn off the humidifier before entering the Standby status.
-

6.12 Turn the System off

Press the  hard key in Standby status to turn the system off.

In non-standby status, if you press the  hard key, the system will prompt [**Please enter Standby mode to shut down the system.**] Select [**Ok**], and the system will remain in non-standby status. Then select the [Standby] key to enter the standby interface after confirmation. Then select the  hard key in Standby to turn the system off.

FOR YOUR NOTES

7 Neonatal Ventilation

7.1 Safety Information

WARNING

- Check the neonatal flow sensor before use. **DO NOT** use the neonatal flow sensor if the sensor's main body, tubing or connector is damaged or occluded.
 - **DO NOT** use the neonatal flow sensor if the neonatal flow sensor tubing is twisted.
 - Before using the neonatal flow sensor for ventilation, please run a system check after configuration of all components required for ventilation. Configuration includes neonatal tubing, neonatal flow sensor and accessories required for the patient circuit. In the event that neonatal flow sensor failure is detected in the system check, please check the patient circuit and the neonatal flow sensor for leak and/or occlusion. Replace the neonatal flow sensor if necessary.
 - After conducting the system check, **DO NOT** add or remove any accessories to or from the circuit, so as not to alter the system resistance and compliance.
 - If a neonatal flow sensor error occurs, stop using the neonatal flow sensor until the error is fixed.
 - The neonatal flow sensor measures the gas flow on the patient's Y piece side. However, the actual flow delivered to the patient will be affected by system leakage between the patient and the neonatal flow sensor.
 - Install the neonatal flow sensor in accordance with the instructions provided in this manual.
 - **DO NOT** place the neonatal flow sensor in a position where the tubing or cables may become easily entangled, knotted or detached. Otherwise, this may result in hypercarbia or hypoxemia.
 - Please **DO NOT** apply pressure to the neonatal flow sensor by pulling the neonatal flow sensor tubing, or rotate the neonatal flow sensor. Otherwise, this will result in increased risk of detachment or disconnection.
 - Please **DO NOT** install the neonatal flow sensor onto the patient tubing if the sensor is not connected to the corresponding ventilator connector.
 - Excessive moisture in the neonatal flow sensor tubing may result in inaccurate measurement. Check the sensor and the tubing periodically to avoid excessive moisture and/or accumulation of secretions.
 - Install the neonatal flow sensor in accordance with the instructions provided in this manual. Sensor installation errors will result in data misinterpretation or incorrect
-

 **WARNING**

ventilator setup. Any attempt of repeat using the disposal neonatal flow sensor might result in cross infection. The neonatal flow sensor is disposable and may not be used repeatedly.

- Do not attempt to clean or disinfect the neonatal flow sensor.
-
-

NOTE

- In non-invasive ventilation, neonate flow sensor is disabled.
-
-

7.2 Connecting Patient Tubing to the Flow Sensor

Refer to 3.5.2 *Install Neonate Tubing*

7.3 Circuit Test

Please make sure that the circuit test is completed before initiation of neonatal ventilation. See 6.3 *Circuit Test* for the circuit test method.

7.4 Start Ventilation

 **WARNING**

- Before using the ventilator on the patient, check that the oxygen concentration in the delivered gas is consistent with the setting value.
 - Adopt manual ventilation immediately if the ventilator malfunctions and cannot continue ventilating the patient.
-
-

1. For patient information setup, please see 6.4 *Select Patient*.
2. For ventilation type setup, please see 6.5 *Ventilation Type*.
3. For ventilation mode setup, please see 6.6 *Ventilation Mode*.
4. For alarm setup, please see 11 *Alarms*.
5. Select the [Start Ventilation] key in Standby status, and the system begins to ventilate the patient according to your settings.



7.5 Backup Ventilation

In the event of a neonatal flow sensor error, the ventilator will switch to backup ventilation if the current ventilation mode is V-A/C, PRVC, PRVC-SIMV, V-SIMV or V-S. During backup ventilation, the user should take corrective measures in a timely manner, including replacing the neonatal flow sensor or using external flow monitoring.

During backup ventilation, the ventilator runs the pressure mode with the delivered inspiratory pressure being equal to PEEP +15 cmH₂O. Other ventilation parameters are identical to those in the original ventilation mode.

When the neonatal flow sensor returns to normal, the ventilator will switch back to the original ventilation mode automatically.

7.6 Set the Monitoring Switch

1. Select [Menu]→[Setup]→[Neo. Module].
2. Set the [Monitoring] to  (ON) or  (OFF).

7.7 Neonatal Flow Sensor Zeroing

Please perform zeroing of the neonatal flow sensor when the measured value has a great deviation. Zeroing can be performed in both standby status and the process of ventilation. See *13.5 Neonatal Flow Sensor Zeroing* for zeroing methods.

FOR YOUR NOTES

8 CO₂ Monitoring

8.1 Introduction

CO₂ monitoring is a continuous, non-invasive technique for determining the concentration of CO₂ in the patient's airway by measuring the absorption of infrared (IR) light of specific wavelengths. The CO₂ has its own absorption characteristic and the amount of light passing the gas probe depends on the concentration of the measured CO₂. When a specific band of IR light is passed through respiratory gas samples, some of IR light will be absorbed by the CO₂ molecules. The amount of IR light transmitted after it has been passed through the respiratory gas sample is measured with a photodetector. From the amount of IR light measured, the concentration of CO₂ is calculated.

The respiration rated range of sidestream CO₂ module is 0 to 150 /min, and the data sample rate is 100 Hz. And the EtCO₂ concentration reading is using the highest values respectively of the temporal CO₂ waveform.

The respiration rated rate range of mainstream CO₂ module is 0 to 150 /min, and the data sample rate 100 Hz. And the EtCO₂ concentration reading is using the peak of the expired CO₂ waveform (Averaging selections: 1 breath, 10 second, 20 second) .

The method used to determine the respiration rated range: Utilize a valve to permit switching between the two sampling gases at different frequencies (simulating the range of specified breath rates). Record the EtCO₂ value presented for each frequency. By drawing the coordinate diagram which indicates the corresponding relationship between end-tidal value and breathing frequency, the range of breathing frequency of EtCO₂ measurement accuracy complying with the specification can be obtained.

Both the mainstream CO₂ module and the sidestream CO₂ module this ventilator is configured with include automatic atmospheric pressure compensation function.

The measurement provides:

1. CO₂ waveform.
2. End-tidal CO₂ (EtCO₂) concentration: the CO₂ concentration measured at the end of the expiration phase.

For the mainstream CO₂ module, in addition to the aforementioned CO₂ waveform and EtCO₂ parameters, the following is also provided:

1. V- CO₂ curve

2. Monitored parameters:

- ◆ VCO₂: CO₂ production for one breath.
- ◆ VDaw: airway dead space.
- ◆ VDaw/TVe: ratio of airway dead space to tidal volume.
- ◆ Vtalv: alveolar tidal volume.
- ◆ MValv: alveolar minute ventilation.
- ◆ slopeCO₂: CO₂ rising slope.
- ◆ MVCO₂: Minute volume of carbon dioxide.
- ◆ VeCO₂: expiratory volume of CO₂.
- ◆ ViCO₂: inspiratory volume of CO₂.
- ◆ VDalv: alveolar dead space (requiring manual input of the patient's blood-gas analysis results).
- ◆ VDalv/TVe: alveolar dead space/tidal volume ratio (requiring manual input of the patient's blood-gas analysis results).
- ◆ VDphy: physiological dead space (requiring manual input of the patient's blood-gas analysis results).
- ◆ VDphy/TVe: physiological dead space/tidal volume ratio (requiring manual input of the patient's blood-gas analysis results).
- ◆ OI: oxygenation index (requiring manual input of the patient's blood-gas analysis results).
- ◆ P/F: partial pressure of oxygen/fraction of inspired oxygen (requiring manual input of the patient's blood-gas analysis results).

Some monitored parameters of the mainstream CO₂ module (VCO₂, VDaw, VDaw/TVe, Vtalv, MValv, slopeCO₂, MVCO₂, VeCO₂, ViCO₂, VDalv, VDalv/TVe, VDphy, and VDphy/TVe) have reference significance only when the patient is in stable ventilation status. Stable ventilation status refers to the following situations:

- Patient is at rest for at least 30 minutes.
- Mechanical ventilation parameters (RR, TV, and etc) remain unchanged.
- No operations that may affect the patient's gas exchange or metabolism.

Some monitored parameters of the mainstream CO₂ module may be inaccurate in the following situations. The affected parameters include VCO₂, VDaw, VDaw/TVe, Vtalv, MValv, slopeCO₂, MVCO₂, VeCO₂, ViCO₂, VDalv, VDalv/TVe, VDphy, and VDphy/TVe.

- System leakage
- Patient ventilation condition is unstable
- High frequency ventilation (HFV)
- Breathing frequency greater than 35/min
- Neonate patient
- Non-invasive ventilation type
- Other circumstance causing wrong CO₂, O₂, and Flow measurements

 **WARNING**

- **Please ensure the cardiopulmonary condition is stable to get the most accurate CO₂ measurement.**
-
-

NOTE

- **CO₂ cannot be measured in the aerosol drug environment. The sampling and monitoring of the CO₂ module are disabled when nebulizer function is initiated.**
 - **As required by the international rules and regulations, oxygen concentration should be monitored when the equipment is used on the patient. If your ventilator is not configured with such monitoring function, use a monitor which complies with related international standards for oxygen concentration monitoring.**
-

8.2 CO₂ Module

As shown in the figure below, from left to right: sidestream CO₂ module and mainstream CO₂ module.

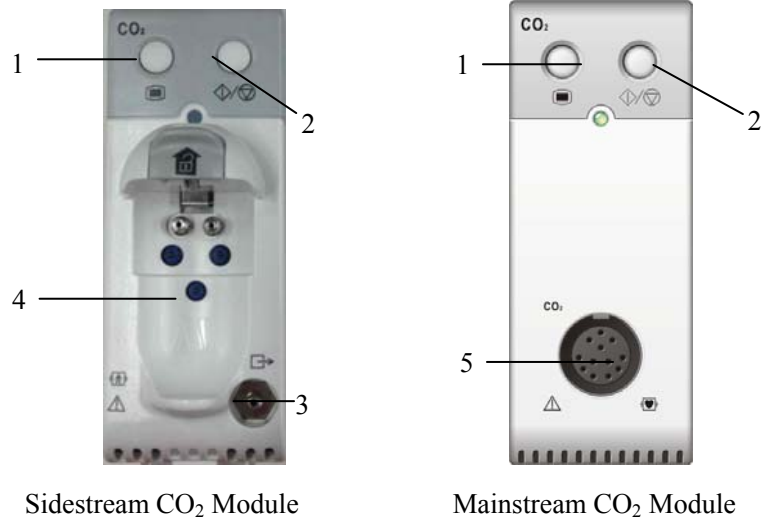

- | | |
|-------------------------------------|-------------------------------------|
| 1. CO ₂ settings menu | 2. Measure/Standby key |
| 3. Gas outlet | 4. CO ₂ watertrap socket |
| 5. CO ₂ sensor connector | |

8.3 Sidestream CO₂ Module

NOTE

-
- This section is only applicable to the ventilator configured with sidestream CO₂ module.
-

8.3.1 Preparation for Measurement

1. Attach the water trap to the water trap fixer and then connect the CO₂ components as shown below.

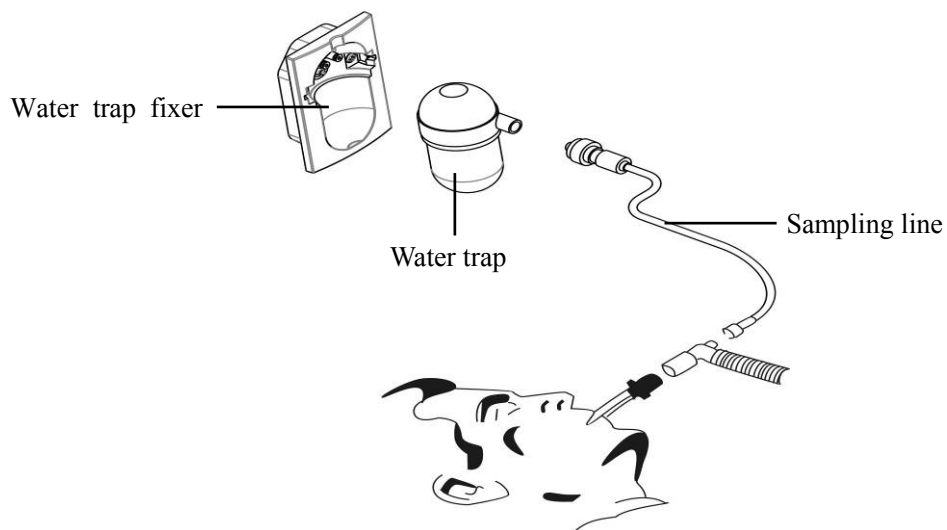

2. By default, the CO₂ module is set in the measurement mode. When the CO₂ module is connected, [CO₂ Startup] is displayed on the screen.
3. After start-up is finished, the [CO₂ Warm-up] message is displayed. The CO₂ module is in ISO accuracy mode. If you perform CO₂ measurements during warm-up, the measurement accuracy may be compromised.
4. After warm-up is finished, the CO₂ module enters full accuracy mode.

NOTE



- To extend the lifetime of the water trap and CO₂ module, disconnect the water trap and set the CO₂ monitoring to OFF when CO₂ monitoring is not required.
 - It takes approximately 2 minutes from powering on the ventilator to reaching the sidestream CO₂ monitoring performance specified in section B.10 of this manual.
 - The sidestream CO₂ measurement can be used, with specified accessories, on intubated and non-intubated, adult and pediatric patients. A sample of the respiratory gas is drawn from the patient's breathing circuit through an airway adapter and a gas sampling line.
 - The gas sampled by the sidestream CO₂ module of this ventilator is a mixture of air and oxygen, and the gas can pass through the gas outlet into the operating environment.
 - When dealing with water trap and sampling line, please comply with related biohazard regulations.
 - Please don't block this connector when the sample gas is emitted from CO₂ Module gas outlet.
-

CAUTION

- The water trap collects water drops condensed in the sampling line, and therefore it prevents water drops from entering the module. If the collected water reaches a certain amount, you should drain it to avoid blocking the airway. Dispose of accumulated fluids in accordance with the hospital policy or your local regulations.
 - The water trap has a filter preventing bacterium, vapor and patient secretions from entering the module. After a long-term use, dust or other substances may compromise the performance of the filter or even block the airway. In this case, replace the water trap. Replacing the water trap once a month is recommended. Or, replace the water trap when it is detected leaky, damaged or contaminated.
-

8.3.2 Make CO₂ Settings

8.3.2.1 Establish CO₂ Settings

When [Monitoring] is set to  (ON), the CO₂ module enters the operating mode. The ventilator displays CO₂ parameters and waveform, and provides physiological alarms and technical alarms related to the CO₂ module. When [Monitoring] is set to  (OFF), the CO₂ module enters standby mode. The ventilator does not display CO₂ parameters and waveform, or provide physiological alarms related to the CO₂ module.

The standby mode of CO₂ module is relevant to the Standby status of ventilator:

- If the ventilator enters Standby status, the CO₂ module also enters standby mode.
- If the ventilator exits Standby status, the CO₂ module is restored to the CO₂ operating mode before standby mode.
- CO₂ module entering or exiting standby mode has no effect upon the ventilator.

To manually enter or exit standby mode, select the [Menu] key→[Setup]→[CO₂ Module]

and set the [Monitoring] to  (OFF) or  (ON).

In standby mode, the working components of the CO₂ module, such as gas pump and infrared light source, are automatically turned off to extend the service life of the module.

8.3.2.2 Set BTPS Compensation

The CO₂ measurement provides:

1. ATPD: Ambient Temperature and Pressure, Dry Gas
2. BTPS: Body Temperature and Pressure, Saturated.

The CO₂ readings will be relatively higher in the presence of moisture. Therefore, the module will use different formulas for each situation to calculate the partial pressure of CO₂:



$$\text{ATPD: } P_{CO_2}(\text{mmHg}) = CO_2(\text{vol}\%) \times P_{amb} / 100$$

$$\text{BTPS: } P_{CO_2}(\text{mmHg}) = CO_2(\text{vol}\%) \times (P_{amb} - 47) / 100$$

where, P_{CO_2} = partial pressure, $\text{vol}\%$ = CO₂ concentration, P_{amb} = ambient pressure, and unit is mmHg.

For CO₂ module, BTPS compensation is switched on or off based on the actual situations.

The settings method is as follows:

1. Select the [Menu] key → [Setup] → [CO₂ Module].
2. Set [BTPS Comp] to  (ON) or  (OFF) in either BTPS or ATPD.

8.3.2.3 Set Unit

1. Select [Menu]→[System]→Enter system password→[Setup].
2. Set [CO₂ Unit]: mmHg, kPa or vol.%.

8.3.2.4 Set the waveform

To set the waveform, please refer to 5.4.3Screen SetupScreen Layout.

8.3.3 Measurement Limitations

Measurement accuracy may be compromised due to:

- Leakage or internal leakage of the sample gas
- Mechanical shock
- Cyclic pressure which is greater than 10 kPa (100 cmH₂O)
- Other interference source (if available)

Measurement accuracy may be affected by the breath rate and I/E ratio as follow:

- When EtCO₂ is within specification for breath rate ≤ 60 /min and I/E ratio $\leq 1:1$, the precision of the EtCO₂ measurement meets the defined specification.
- When EtCO₂ is within specification for breath rate ≤ 30 /min and I/E ratio $\leq 2:1$, the precision of the EtCO₂ measurement meets the defined specification.

8.3.4 Troubleshooting

When the sampling system of the CO₂ module works abnormally, check if the sampling line is kinked. If not, remove the sampling line from the water trap. Then, if a prompt message indicating airway malfunction appears on the screen, it means that the water trap is occluded. In this case, you must replace the water trap. If no such prompt message is displayed, it means that the sampling line is occluded. Then you must replace the sampling line.

8.3.5 Zero the Sensor

Zeroing the sensor aims to eliminate the effect of baseline drift on the readings during the measurement, so as to ensure measurement accuracy.

For CO₂ module, a zero calibration is carried out automatically if necessary. If necessary, the user may also perform zeroing manually: select [**Menu**] → [**Calibration**] → [**CO₂ In Maintenance**] and then select the [**Zero the Sensor**]. Do not need to disconnect the sensor from the breathing system when performing the zeroing.

8.3.6 Calibrate the Sensor

For a sidestream CO₂ module, a calibration should be performed once a year or when the measured value has a great deviation. For further details, refer to 13Chapter 14 “Maintenance”.

8.4 Mainstream CO₂ module

NOTE

-
- This section is only applicable to the ventilator configured with mainstream CO₂ module.
-

8.4.1 Preparation for Measurement

1. Connect the sensor to the CO₂ module.
2. By default, the mainstream CO₂ module is set to the measurement mode. When the CO₂ module is inserted, the prompt message [CO₂ Sensor Warmup] will be displayed on the screen.
3. After warm-up is finished, connect the sensor to the airway adapter.
4. Perform a zero calibration, referring to **8.4.4Zero**
5. After the zero calibration is finished, connect the airway as shown below.

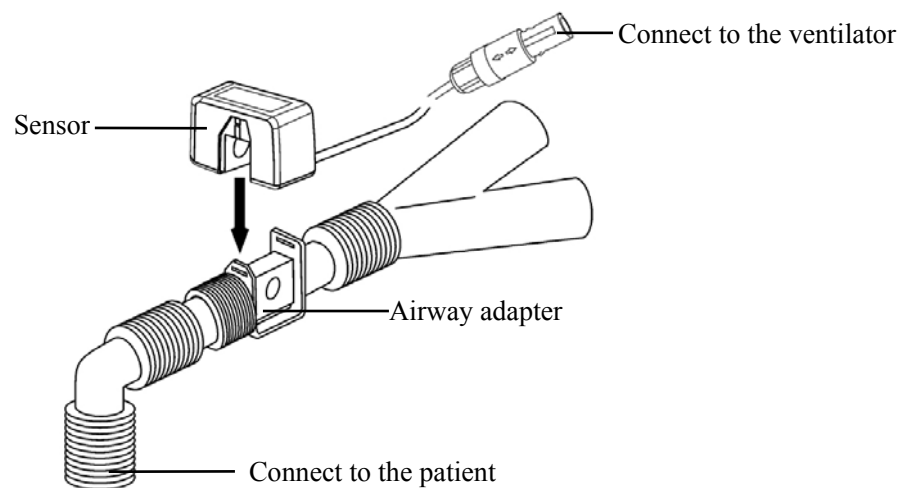

6. Ensure that there are no leakages in the airway, and then perform CO₂ measurements.

WARNING

-
- Always ensure the integrity of the patient breathing circuit by verifying a proper CO₂ waveform on the ventilator display after insertion of the airway adapter.
 - If the CO₂ waveform appears abnormally, inspect the CO₂ airway adapter. Replace it if needed.
-

WARNING

- Do not use the CO₂ sensor if it appears to have been damaged or if it fails to operate normally. Contact the Customer Service Department.
 - To reduce the risk of explosion, do not place the CO₂ sensor in a combustible or explosive environment.
 - Inspect the CO₂ airway adapter periodically for excess moisture and secretion accumulation.
 - Avoid extended direct contact of the CO₂ sensor with the human body.
-

CAUTION



- To prevent premature failure of the CO₂ sensor, the CO₂ monitoring function is switched off from the moment of in which nebulization is activated until one minute after nebulization is completed. The medication may contaminate the airway adapter window due to its viscosity. It is suggested to remove the CO₂ sensor and airway adapter from the pneumatic circuit.
-

NOTE

- Always position the sensor above the adapter in an upright position to avoid collection of fluids on the windows of the adapter. Large concentrations of fluids at this point will obstruct gas analysis.
 - It takes approximately 2.5 minutes from powering on the CO₂ measurement to reaching the mainstream CO₂ monitoring performance specified in section B.10 of this manual.
 - The mainstream CO₂ measurement can be used, with specified accessories, on intubated and non-intubated, adult, pediatric and neonate patients.
-

8.4.2 Make CO₂ Settings

8.4.2.1 Establish CO₂ Settings

When [**Monitoring**] is set to  (ON), the CO₂ module enters the operating mode. The ventilator displays CO₂ parameters and waveform, and provides physiological alarms and technical alarms related to the CO₂ module. When [**Monitoring**] is set to  (OFF), the CO₂ module enters standby mode. The ventilator does not display CO₂ parameters and waveform, or provide physiological alarms related to the CO₂ module.

The standby mode of CO₂ module is relevant to the Standby status of ventilator:

- If the ventilator enters Standby status, the CO₂ module also enters standby mode.
- If the ventilator exits Standby status, the CO₂ module is restored to the CO₂ operating mode before standby mode.
- CO₂ module entering or exiting standby mode has no effect upon the ventilator.

To manually enter or exit standby mode, select the [Menu] key→[Setup]→[CO₂ Module]

and set the [Monitoring] to  (OFF) or  (ON).

In standby mode, the working components of the CO₂ module, such as infrared light source, are automatically turned off to extend the service life of the module.

8.4.2.2 Set Unit

1. Select [Menu]→[System]→Enter system password→[Setup].
2. Set [CO₂ Unit]: mmHg, kPa or vol.%.

8.4.2.3 Set the waveform

To set the waveform, please refer to 5.4.3Screen SetupScreen Layout.

8.4.3 Measurement Limitations

Measurement accuracy may be compromised due to:

- Leakage or internal leakage of the sample gas
- Mechanical shock
- Cyclic pressure which is greater than 10 kPa (100 cmH₂O)
- Other interference source (if available)

8.4.4 Zero the Sensor

Zeroing the sensor aims to eliminate the effect of baseline drift on the readings during the measurement, so as to ensure measurement accuracy.

In the following situations, zeroing of the sensor is required:

1. The adapter is replaced.
2. The sensor is re-connected to the module.

-
3. When the sensor is not set in the optimal measurement mode and the ventilator displays the prompt message **[CO₂ Zero Required]**. In this case, check the airway adapter for blockage. If a blockage is detected, clear or replace the adapter.

To zero the sensor, do as follows:

1. Connect the sensor to the CO₂ module.
2. Select the **[Menu]** key → **[Setup]** → **[CO₂ Module]** and then set **[Monitoring]** to  (ON).
3. After warm-up is finished, connect the sensor to a clean, dry airway adapter. The adapter should be vented to the air and isolated from CO₂ sources, including ventilator, the patient's breathing and your own breathing.
4. Select the **[Menu]** key → **[Calibration]** → **[CO₂ In Maintenance]** and then select the **[Start]** key corresponding to CO₂ zeroing on the right side of the screen. The screen displays **[CO₂ Zero Running]**.
5. A typical zeroing takes about 15 to 20 seconds. This message disappears after zeroing is completed.

WARNING

- **Before zeroing the sensor during the measurement, disconnect the sensor from the breathing system first.**
 - **Failure to zero the mainstream CO₂ correctly may result in data display error. During the zeroing, the airway adapter and the CO₂ sensor should not be connected to the patient tubing.**
-

8.4.5 Calibrate the Sensor

For a mainstream CO₂ module, calibration is not required. The system sends altitude to the mainstream CO₂ module for calibration compensation. Contact the company's Customer Service Department if calibration is necessary.

9 SpO₂ Monitoring

9.1 Introduction

SpO₂ monitoring is a non-invasive technique, used to measure the amount of oxygenated haemoglobin and pulse rate by measuring the absorption of selected wavelengths of light. The light generated in the sensor passes through the tissue and is converted into electrical signals by the photo detector in the sensor. The SpO₂ module processes the electrical signal and displays a waveform and digital values for SpO₂ and pulse rate.

This device is calibrated to display functional oxygen saturation.

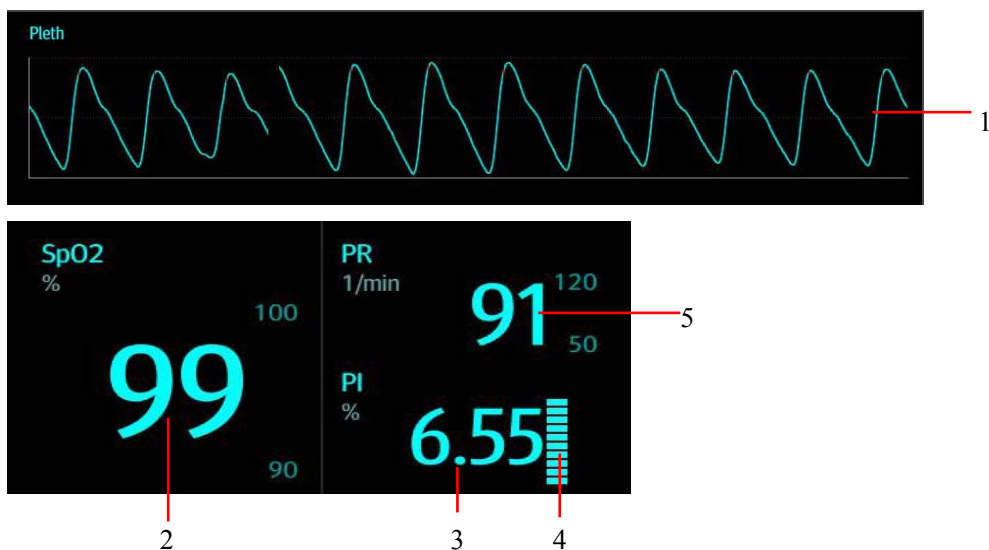

1. Pleth waveform: visual indication of patient's pulse. The waveform is not normalized.
2. Oxygen saturation of arterial blood (SpO₂): percentage of oxygenated hemoglobin in relation to the sum of oxyhemoglobin and deoxyhemoglobin.
3. Perfusion index (PI): gives the numerical value for the pulsatile portion of the measured signal caused by arterial pulsation. PI is an indicator of the pulsatile strength. You can also use it to assess the quality of SpO₂ measurement. Above 1 is optimal, between 0.3 and 1 is acceptable. Below 0.3 indicates low perfusion; reposition the SpO₂ sensor or find a better site. If low perfusion persists, choose another method to measure oxygen saturation if possible
4. Perfusion indicator: the pulsatile portion of the measured signal caused by arterial pulsation.
5. Pulse rate (derived from pleth wave): detected pulsations per minute.

NOTE

- Mindray SpO₂ connector can only be connected to the Mindray SpO₂ extension cable.
 - A functional tester or SpO₂ simulator can not be used to assess the accuracy of a SpO₂ module or a SpO₂ sensor.
 - A functional tester or SpO₂ simulator can be used to determine the pulse rate accuracy.
 - SpO₂ simulator cannot be used to validate the accuracy of the Oxygen saturation monitor and SpO₂ sensor. The accuracy of Oxygen saturation monitor and SpO₂ sensor must be validated with clinical data.
 - Qualification and compliance testing in line with ISO 80601-2-61 should be conducted for the ventilator, as well as the SpO₂ probe and the probe extension cable that are intended to be used together with this ventilator.
-

9.2 Safety Information

WARNING



- Use only SpO₂ sensors and cables specified in this manual. Follow the SpO₂ sensor's instructions for use and adhere to all warnings and cautions.
 - When a trend toward patient deoxygenation is indicated, blood samples should be analyzed by a blood gas analyzer to completely understand the patient's condition.
 - Do not use SpO₂ sensors during magnetic resonance imaging (MRI). Induced current could potentially cause burns.
 - Prolonged continuous monitoring may increase the risk of undesirable changes in skin characteristics, such as irritation, reddening, blistering or burns. Inspect the sensor site every two hours, and move the sensor if the skin quality changes. For patients with poor peripheral blood circulation or sensitive skin, inspect the sensor site more frequently. Prolonged continuous monitoring may increase the risk of undesirable changes in skin characteristics, such as irritation, reddening, blistering or pressure necrosis.
-

9.3 Applying the Sensor

1. Select an appropriate sensor according to the module type, patient category and weight.
2. Remove colored nail polish from the application site, if applicable.
3. Apply the sensor to the patient.
4. Plug adapter cable into the SpO₂ connector on the ventilator.
5. Connect the sensor cable to the adapter cable.

9.4 Make SpO₂ Settings

9.4.1 Set SpO₂ Monitoring

Select the [Menu] key → [Setup] → [SpO₂ Module] and then set [Monitoring] to  (OFF) or  (ON).

9.4.2 Set Sensitivity

The SpO₂ value displayed on the ventilator screen is the average of data collected within a specific time. Sensitivity from high to low indicates the average time from short to long. Select the [Menu] key → [Setups] → [SpO₂ Module] and then set [Sensitivity] to [High], [Med] or [Low]. When the [Sensitivity] is set to [High], the ventilator is more sensitive to minor signals. To monitor critically ill patients whose pulsations are very weak, it is strongly recommended to set the sensitivity to [High]. During monitoring non-critically ill patients who tend to move a lot, noise or invalid signals may result. In this case, it is recommended to set the sensitivity to [Med] or [Low], so that the interference caused by motion can be filtered, and therefore the measurement stability can be ensured.

9.4.3 Beat Volume

Select [Menu] key → [Setup] → [SpO₂ Module]. Adjust the beat volume by selecting the [+](increase) or [-](decrease) keys. The beat volume has 10 levels of adjustment, with 10 being the maximum volume.

9.4.4 Set CO₂ Waveform

Select the [Menu] key → [Setup] → [SpO₂ Module] to set [Sweep Speed] to [12.5 mm/s] or [25 mm/s].

9.5 Measurement Limitations

If you are unsure of the accuracy of measurement results, please examine the patient's vital signs using other methods, and then examine the ventilator and SpO₂ sensor. During the measurement process, the following factors may impact the measurement accuracy:

- Ambient light
- Physical movement (patient and imposed motion)
- Diagnostic testing
- Low perfusion
- Electromagnetic interference, such as MRI environment
- Electrosurgical units
- Dysfunctional haemoglobin, such as carboxyhemoglobin (COHb) and methemoglobin (MetHb)
- Presence of certain dyes, such as methylene and indigo carmine
- Inappropriate positioning of the SpO₂ sensor, or use of incorrect SpO₂ sensor
- Drop of arterial blood flow to immeasurable level caused by shock, anemia, low temperature or vasoconstrictor.

10 Special Functions

10.1 Manual Breath

Select the [Tools] key→[Basic]→[Manual Breath], and the ventilator system will deliver a breath to the patient based on the current ventilation mode.

NOTE

- Pressing the [Manual Breath] key during inspiratory phase cannot start a manual breath.
 - Manual breath function is disabled in CPAP mode. When apnea ventilation occurs, the manual breath function is supported.
 - Manual breath is disabled in standby status, oxygen therapy or CPRV mode.
 - The system will not respond to manual breath key operation during PEEPi, P0.1, NIF measurements.
-

10.2 Expiration Hold

Expiration Hold means to extend the patient's time of expiratory phase manually and to prevent the patient from inspiration for a certain period of time.

Select the [Tools] key→[Basic]→[Exp.Hold]. Push and hold the [Exp.Hold] key. The ventilator starts the expiration hold function and the screen displays [Exp.Hold Active]. Release the [Exp.Hold] key. The ventilator terminates the expiration hold function. Expiration Hold is active for a maximum of 30 seconds (for adults and pediatric) or 5 seconds (for neonates). If the [Exp.Hold] key is pressed and held for more than the maximum time or is released, the ventilator terminates the Expiration Hold function automatically.

During expiration hold, the ventilator calculates PEEPi automatically and displays the calculation results in the prompt message box.

NOTE

- There is at least one inspiratory phase between two expiration holds.
 - The system will not respond to expiration hold key operation while in standby, oxygen therapy, nCPAP or CPRV modes.
 - Expiration Hold function is disabled in CPAP mode And is supported when apnea ventilation occurs.
 - The system will not respond to expiration key operation during PEEPi and P0.1 measurements.
-

10.3 Inspiration Hold

Inspiration Hold means to extend the patient's time of inspiratory phase manually and to prevent the patient from expiration for a certain period of time.

Select the [Tools] key→[Basic]→[Insp.Hold]. Push and hold the [Insp. Hold] key. The ventilator will start the inspiration hold function and the screen displays [Insp.Hold Active]. Release the [Insp.Hold] key. The ventilator terminates the inspiration hold function.

Inspiration Hold is active for a maximum of 30 seconds (for adults and pediatric) or 5 seconds (for neonates). If the [Insp.Hold] key is pushed and exceeds the maximum time, the ventilator will terminate the inspiration hold function automatically.

During Inspiration Hold, the ventilator calculates Cstat and Pplat automatically and displays the calculation results in the prompt message box.

NOTE

- **There is at least one expiratory phase between two inspiration holds.**
 - **The system will not respond to inspiration hold key operation in standby, oxygen therapy, nCPAP or CPRV modes.**
 - **The expiration hold function is disabled in CPAP mode. When apnea ventilation occurs, the expiration hold function is supported.**
 - **The system will not respond to inspiration hold key operation during PEEPi, P0.1, NIF measurements.**
-

10.4 Nebulizer

WARNING

- **Remove the mainstream CO₂ module adapter from patient's ventilator tubing before initiating nebulization. CO₂ cannot be measured in the aerosol drug environment.**
 - **Remove the neonatal flow sensors from patient's ventilator tubing before initiating nebulization. Neonatal flow cannot be measured in the aerosolized medication environment.**
 - **DO NOT administer nebulized medications when the neonatal flow sensor is used. The drug may damage the neonatal flow sensor.**
 - **Aerosolized medication may occlude the expiration valve and flow sensor. Please have them checked and cleaned after nebulization.**
-

 **CAUTION**

- **Remove the nebulizer after completing nebulization, otherwise ventilation may be affected.**
 - **The remaining nebulized drug will affect the surrounding air.**
-

During nebulization, aerosolized medicament is inhaled by the patient for the purpose of therapy.

10.4.1 Pneumatic Nebulizer

Press the [Nebulizer] key and set the appropriate [Time] in the accessed menu. Select [Ok] to start nebulization. When [Nebulizer] starts, nebulization remaining time is displayed in the system prompt message field.

When the set nebulization time is up or the [Nebulizer] key is pressed again, the ventilator terminates nebulization.

NOTE

- **Nebulization is disabled in standby, oxygen therapy or CPRV mode.**
 - **When [O₂ Supply Failure] alarm or [No Gas Supply Pressure] alarm is triggered, click [Nebulizer] key, nebulization is disabled and prompts [O₂ Supply Failure. Nebulizer disabled.].**
 - **If O₂↑ process triggers [O₂ Supply Failure] alarm or [No Gas Supply Pressure] alarm, nebulizer stops.**
 - **Nebulization is disabled in V-A/C, V-SIMV, PRVC-SIMV, VS, AMV and PRVC modes when the patient type is pediatric patients.**
 - **Nebulization may cause fluctuations in the patient's FiO₂.**
 - **For adults or pediatric patients, the nebulization flow of ventilator is zero when the inspiratory flow is less than 15 L/min.**
 - **Pneumatic nebulization is disabled when the patient type is neonates.**
-

10.4.2 Electronic Nebulizer

Refer to the nebulizer accompanying operator's manual to install and use the electronic nebulizer.

 **WARNING**

- **During the use of the electronic nebulizer, please pay attention to the connection of the nebulizer to prevent the nebulization interruption .**
-

10.5 O₂↑(Oxygen Enrichment)

O₂↑ is also called as O₂ enrichment. It means to deliver oxygen with concentration higher than normal level within the specified time period. The oxygenation magnitude can be set by selecting [Menu] → [Setup] → [Ventilation]. The default oxygen enrichment magnitude is 60% for adult and pediatric patients, and 10% for neonate patients.

Press the [O₂↑Suction] key and the ventilator starts oxygen enrichment. At that time, the indicator light for [O₂↑Suction] key will be illuminated, and the remaining oxygen enrichment time will be displayed. Oxygen enrichment is active for maximum two minutes. During oxygen enrichment, the currently set oxygen concentration is displayed in the [O₂ %] parameter setup quick key field.

When the 2-minute period of oxygen enrichment is up or the [O₂↑Suction] key is pressed again, the ventilator terminates oxygen enrichment.

NOTE

- **The system cannot start O₂↑ (oxygen enrichment) in the standby, oxygen therapy, or CPRV modes.**
 - **The system cannot start O₂↑ (oxygen enrichment) in the P-V tool test process.**
 - **When [O₂ Supply Failure] alarm or [No Gas Supply Pressure] alarm is triggered, click [O₂↑ Suction] key, O₂↑ is disabled and prompts [O₂ Supply Failure, O₂↑ disabled].**
 - **If O₂↑ process triggers [O₂ Supply Failure] alarm or [No Gas Supply Pressure] alarm, O₂↑ stops.**
 - **Removing the patient tubing during oxygen enrichment will start suction function. Refer to 10.6Suction section.**
-

10.6 Suction

The ventilator detects the procedure of disconnecting or reconnecting the patient tubing when the ICU staff conducts the suction maneuver for patients. The ventilator starts oxygen enrichment before and after the suction, and disables the otherwise relevant alarm messages during the suction.

1. Press the [**O₂↑ Suction**] key. The system delivers oxygen enrichment to the patient and monitors within the 120-second period of oxygen enrichment if the patient tubing are disconnected. Disconnect the patient tubing in this period.
2. After disconnecting the patient tubing, the system prompts [**The Patient is Disconnected! Reconnect Patient after Suction Completed!**], system stops ventilating the patient. In this case, you can apply manual suction to the patient.
3. Reconnect the patient tubing after the suction. When patient connection is detected, the system delivers oxygen enrichment to the patient for 120s.

During the oxygen enrichment periods, pressing the [**O₂↑Suction**] key can terminate the procedure.

NOTE

-
- **P0.1, PEEPi, and NIF are disabled after suction is activated.**
 - **The system cannot start O₂↑ suction in the Standby modes, O₂ therapy or CPRV modes.**
-

10.7 P0.1

P0.1 is the occlusion pressure drop within the first 100 ms after a patient starts spontaneous breathing.

1. Select the [**Tools**] key→[**Advanced**]→[**P0.1**].
2. Select [**P0.1**] to access the P0.1 measurement window.
3. Select [**Start**] in the opened screen. The system starts P0.1 measurement and prompts [**Measurement Active**].
4. After the measurement is completed, the measurement result is displayed. The ventilator can display the three most recent measurement results.
5. After the measurement is completed, waveforms and spirometry data are frozen automatically.

NOTE

- **Suction, PEEPi, and NIF are disabled after P0.1 is activated.**
 - **During P0.1 measurement, by pressing the [Freeze] key, the system will not proceed with the freezing operation.**
 - **P0.1 cannot be started in the standby, oxygen therapy, CPRV or neonate modes.**
 - **P0.1 cannot be started during the suction process.**
-

10.8 PEEPi

The PEEPi measurement function supports measurement of two parameters: PEEPi and Vtrap. PEEPi is the positive end-expiratory pressure produced by the trapped gas and Vtrap is the trapped gas volume.

1. Select the [**Tools**] key→[**Advanced**]→[**PEEPi**].
2. Select [**PEEPi**] to access the PEEPi measurement window.
3. Select [**Start**] in the opened screen. The system will initiate PEEPi measurement and prompts [**Measurement Active**].
4. After the measurement is completed, the measurement result is displayed. The ventilator can display the three most recent measurement results.
5. After the measurement is completed, waveforms and spirometry data are frozen automatically.

NOTE

- **During PEEPi measurement, by pressing the [Freeze] key, the system will not proceed with the freezing operation.**
 - **Manual Breath, Inspiration Hold, and Expiration Hold are disabled during PEEPi measurement.**
 - **PEEPi cannot be started in standby, oxygen therapy or CPRV modes.**
 - **PEEPi cannot be started in neonate mode.**
-

10.9 NIF

NIF is the maximum negative pressure generated by the patient's spontaneous breathing within a period of time.

1. Select the [Tools] key→[Advanced]→[NIF].
2. Select [NIF] to access the NIF measurement window.
3. Press and hold the [Exp. Hold] key on the screen and the system starts NIF measurement.
4. Release the [Exp. Hold] key. The measurement is completed. The measurement result is displayed. The ventilator can display the three most recent measurement results.

NOTE

- **NIF cannot be started in the standby, oxygen therapy or CPRV modes.**
 - **NIF cannot be started in neonate mode.**
 - **NIF is disabled during the suction process.**
-

10.10 Calculation of Alveolar Ventilation

Alveoli ventilation calculation functions refer to the calculation of alveolar dead space, alveolar ventilation volume, and oxygenation index, among other physiological parameters for patients, with arterial blood gases information PaCO₂ and PaO₂ entered by the user. As shown in the table below:

Abbreviation	Unit	Full name
PaCO ₂	mmHg/kPa	Arterial carbon dioxide pressure
PaO ₂	mmHg/kPa	Arterial oxygen partial pressure
MVCO ₂	mL/min	CO ₂ elimination.
VD _{alv}	mL	Alveolar dead space

VDphy/TVe	%	Percentage of physiological dead space to tidal volume
VDphy	mL	Physiological dead space
MValv	mL/min	Alveolar minute ventilation
OI	/	Oxygenation index
P/F	/	Oxygenation rate

1. Select the [Tools] key→[Advanced]→[Alv. Vent Cal.].
2. Select [Alv. Vent Cal.] to enter the function screen.
3. Input the arterial blood gases information PaCO₂ and PaO₂ and click on [Calculate] on the screen that appears. The system will calculate and display the result in a table. The ventilator can display the 9 most recent measurement results.

NOTE

-
- Alveoli ventilation calculation cannot be started in the standby, oxygen therapy or CPRV modes.
-

10.11 P-V Tool

Mechanical ventilation set with the optimal PEEP can improve oxygenation, improve alveolar mechanics and reduce injury to the lungs. By drawing static pressure-volume loop (static P-V loop), P-V tool is the method to determine the optimal PEEP based on the characteristic points on the static P-V loop. The doctor is able to determine the optimal PEEP for the patient with the help of this function.

NOTE

-
- The P-V tool function is disabled in the following cases: in standby status; when the patient size is pediatric patient or neonate; in CPAP/PSV, VS, NIV or apnea ventilation modes; during O₂↑(oxygen enrichment); during P0.1 measurement; during nebulization or suction; within one minute after nebulization or suction; within one minute after the most recent P-V loop measurement.
 - The P-V tool function is not recommended when there is great leakage or when the patient has spontaneous breathing. The relevant characteristic points, that the P-V tool function provides are only for your reference.
 - If no operation is performed on P-V tool window within three minutes, the measurement window exits automatically.
-

-
1. Select [**Tools**] → [**Advanced**] → [**P-V Tools**].
 2. Select [**P-V Tools**] to access the P-V tools window.
 3. Read notes related to P-V tool on the Info screen.
 4. Select [**Procedure**], and set parameters of Pstart, Flow, Pmax, and Vlimit on the Procedure screen. The system acquires Tmax parameter value based on the calculation formula and displays it on the procedure screen.
 - Flow: gas delivery and expiration flows of the static P-V loop.
 - Pstart: starting pressure of the static P-V loop.
 - Pmax: maximum pressure which the static P-V loop can reach.
 - Vlimit: maximum volume which the static P-V loop can reach.
 - Tmax: maximum measurement time required for completing static P-V loop measurement.
 5. Select [**Start**] and the system starts P-V tool measurement. If you select [**Stop Insp**] during measurement, the system stops measurement test in the inspiratory limb immediately and starts measurement in the expiratory limb. If you select [**Abort**] during measurement, the system aborts measurement immediately.
 6. After the measurement is completed, the system enters Analysis screen. You can set the desired positions of [**Cursor 1**] and [**Cursor 2**]. When you select [**Cursor 1**] or [**Cursor 2**], the selected cursor turns green. You can move the position of the cursor via the control knob to determine the characteristic points. The system also displays the volume value and pressure value in the inspiratory limb and expiratory limb corresponding to the cursor position and displays the compliance of these limbs.
 7. Click [**History**] to select the desired loop in the accessed list. The system only displays the history loop you are viewing.
 8. Select [**Ref. Loop**] to select the desired loop in the accessed list. The system displays the reference loop you are viewing and the current loop as well.

10.12 Recruitment Tool (SI)

The lung recruitment function is a ventilation strategy to protect the lungs. Administer a pressure higher than that of the regular average airway during mechanical ventilation and maintain for a specified period of time, which can reopen more collapsed alveoli and prevent secondary atelectasis to small tidal volume.

The SI recruitment ventilation function uses the constant pressure ventilation method to provide a single-cycle recruitment maneuver.

NOTE

- **Pure oxygen ventilation or high-concentration oxygen ventilation is used during the SI recruitment maneuver.**
 - **The SI recruitment maneuver function is not recommended in the case that the patient evidences spontaneous breathing.**
 - **The SI recruitment maneuver should be suspended if the patient's physiological status is abnormal.**
 - **The SI function cannot be used in the following situations: with neonate patients; during Suction; and during O₂ therapy.**
-

1. Select [Tools] → [Advanced] → [SI] to enter the lung recruitment tools screen.
2. Select the [Note] interface, and read the notes related to the recruitment tool on the opened screen.
3. Select [Procedure] interface, and set [Pressure Hold] and [Hold Time] these two parameters. Parameter settings for recruitment maneuver:
 - ◆ [Pressure Hold]: The pressure hold for the lung recruitment process.
 - ◆ [Hold Time]: The length of time for which the lung recruitment process lasts.

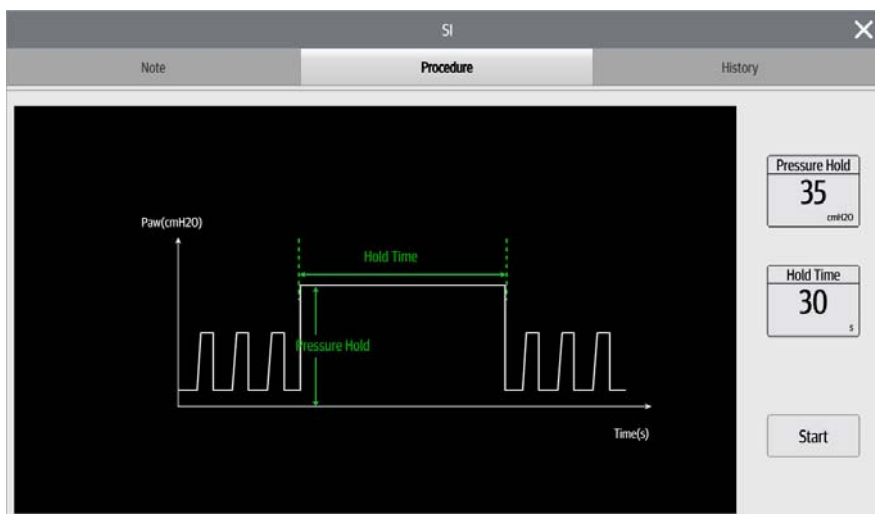

-
4. Press the [**Start**] key and the system will start SI ventilation. When Hold Time expires, SI ventilation will terminate automatically. Press the [**Stop**] key during SI ventilation and the recruitment maneuver will stop immediately.

10.12.1 History

1. Select [**Tools**] → [**Advanced**] → [**SI**] to enter the lung recruitment tools screen.
2. Select [**History**] to view all recruitment history information for the patient.

10.13 Weaning Tools

WARNING

- **The ventilator only provides parameter trends and changes to aid doctors with weaning screen and spontaneous breathing trials, and does not advise or indicate whether weaning can be applied or whether weaning is successful. Healthcare providers should make decisions and take measures based on the patient's clinical conditions.**
-

If a patient's condition improves after using ventilator for a period of time, ventilator weaning can be exercised to restore spontaneous breathing. Before ventilator weaning is conducted, daily weaning screen and spontaneous breathing trials should be performed based on the patient's condition. The patient's breathing status and vital signs should be closely monitored in this process to evaluate whether weaning can be exercised, and whether it is successful.

The ventilator provides the dynamic trend and change of the following parameters: TVe/IBW, fspn, MVe, NIF, EtCO₂, SpO₂, PR, SpO₂/FiO₂. Users can set the normal ranges of TVe/IBW, fspn, EtCO₂, SpO₂, PR and observe the changes in these parameters. During weaning, users can observe the changes in parameter trends to evaluate the vital signs and breathing status of the patient, in order to support decision-making regarding whether weaning is successful.

NOTE

- **The SBT function cannot be used in the CPRV, NIV, Standby, O₂ Therapy or when the apnea alarm is triggered.**
-

10.13.1 Help Information Viewing

1. Select [Tools] → [Advanced] → [Weaning] to enter the weaning support tool screen.
2. Select [Information] to check the basic principle of the weaning support tool and precautions.

10.13.2 Spontaneous Breathing Trial (SBT)

Spontaneous breathing trial (SBT): users can set and start an SBT, and the ventilator will perform PSV ventilation according to the preset parameters, while also displaying the real-time values and trends of weaning criteria. If the criteria exceed the preset range, the PSV ventilation will terminate automatically and the original ventilation mode will be reinstated.

1. Select [Tools] → [Advanced] → [Weaning] to enter the weaning support tool screen.



2. Select [SBT] interface and long press [NIF] key and the system will activate NIF measuring function. NIF is the maximum negative pressure generated by the patient's spontaneous breathing within a period of time. Release the [NIF] key. The measurement is completed. The measurement result is displayed.
3. Set [PEEP], [ΔPsupp] and [FiO₂] and [Duration] (setting range: 20min to 240min) and [Tolerance] (setting range: 100s to 300s).
4. Press the [Criteria] key to enter the judgment indicator settings screen. You can return to the SBT screen after completing the settings. You can also press the [Auto Limits] key, the ventilator will automatically change the judgment parameters according to the algorithm. The algorithm is as follows:

Limits	Formula
fspn high limit	$1.5 \times \text{fspn monitored value}$, not more than 160/min
fspn low limit	$0.5 \times \text{fspn monitored value}$
TVe/IBW high limit	15mL/kg

TVe/IBW low limit	4mL/kg
EtCO ₂ high limit	EtCO ₂ average value+10mmHg
EtCO ₂ low limit	Adult: 15mmHg; Pediatric: 20mmHg
SpO ₂ high limit	100%
SpO ₂ low limit	90%
PR high limit	1.2 × PR monitored value, not more than 300/min
PR low limit	0.8 × PR monitored value, not less than 15/min

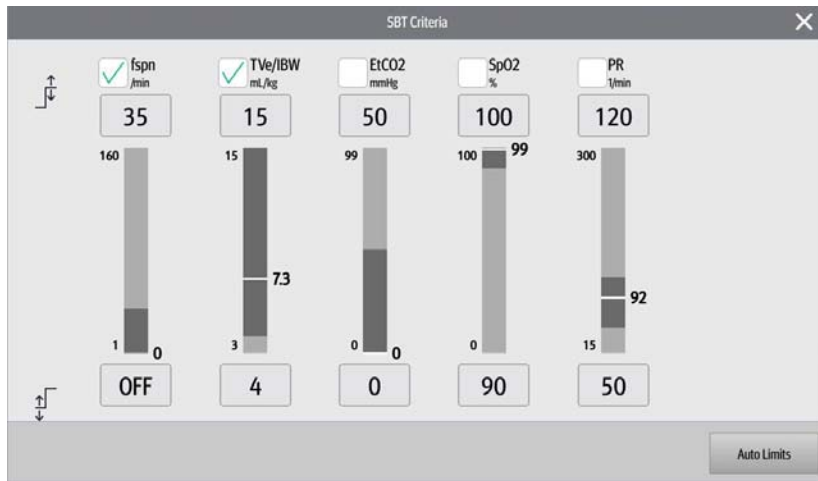

5. Select [**Start**] for the system to start SBT and display remaining SBT time. If you select the [**Stop**] key during SBT, the system will terminate SBT and return to the original ventilation mode. When the countdown is finished, the system will terminate SBT and return to the original ventilation mode. If any weaning criteria exceeds the preset range and the duration exceeds the tolerance time during SBT, the system will terminate SBT and return to the original ventilation mode. If the apnea alarm is triggered, the system will terminate SBT and return to the original ventilation mode.

10.13.3 History

1. Select [**Tools**] → [**Advanced**] → [**Weaning**] to enter the weaning support tool screen.
2. Select [**History**] to view all history weaning information for the patient.

10.14 O₂ Therapy

O₂ therapy is a method to increase O₂ concentration in the airway at normal pressure through simple tube connections. O₂ therapy is a medical measure which can increase O₂ concentration in the alveolar gas and facilitate O₂ diffusion so as to increase PaO₂ and SpO₂ saturation and relieve or correct hypoxia by increasing O₂ concentration in the inspired gas. O₂ therapy is a way for hypoxia prevention or treatment, providing O₂ concentration higher than that in the air.

WARNING

- **O₂ therapy can only be used on patients with spontaneous breathing.**
 - **During O₂ therapy, only the O₂ concentration FiO₂, O₂ flow, SpO₂, and pulse rate are monitored.**
 - **During O₂ therapy, all physiological alarms are shielded except O₂ concentration physiological alarms.**
 - **Airway pressure and expiration-dependent ventilation parameters, such as flow, minute volume, or apnea, are not monitored.**
 - **Use SpO₂ monitoring for patients who are dependent only on an increased defined O₂ concentration. Otherwise, a deterioration in the patient's condition cannot be recognized.**
 - **Only use oxygen masks or nasal catheters for O₂ Therapy. Do not use masks for non-invasive ventilation (NIV). The patient may be at risk if unsuitable masks are used.**
 - **Insufficient source pressure may cause inaccurate control of oxygen concentration.**
-

10.14.1 Preparing for O₂ Therapy

WARNING

- **Do not use antistatic or conductive patient tubing. The use of such materials increases the risk of an electric shock for the patient and the risk of fire breaking out in oxygen- enriched atmospheres.**
-

10.14.1.1 Using O₂ Therapy Mask for O₂ Therapy

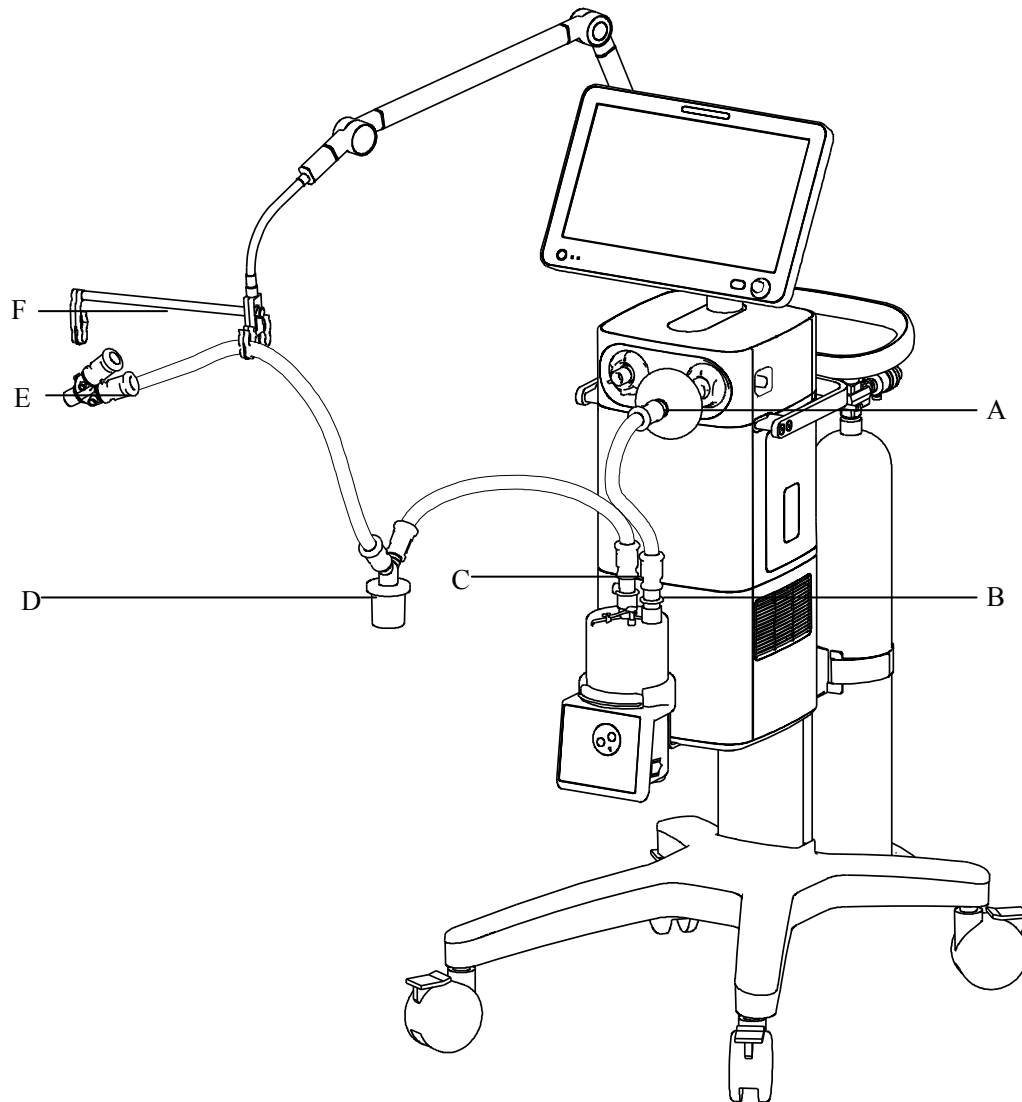

- A. Inspiratory Filter B. Humidifier inlet C. Humidifier outlet
D. Inspiratory water trap E. Y piece (connected with the oxygen therapy mask)
F. Support arm hook

1. Mount the filter onto the inspiratory port.
2. Connect the inspiratory filter to the humidifier inlet via the tube.
3. Connect the humidifier outlet to the water trap via the tube. Then, connect the water trap to the Y piece via the tube.
4. The expiratory port is not connected with a tube.
5. Place the tubes onto the support arm hook.

10.14.1.2 Using Nasal Cannula for O₂ Therapy

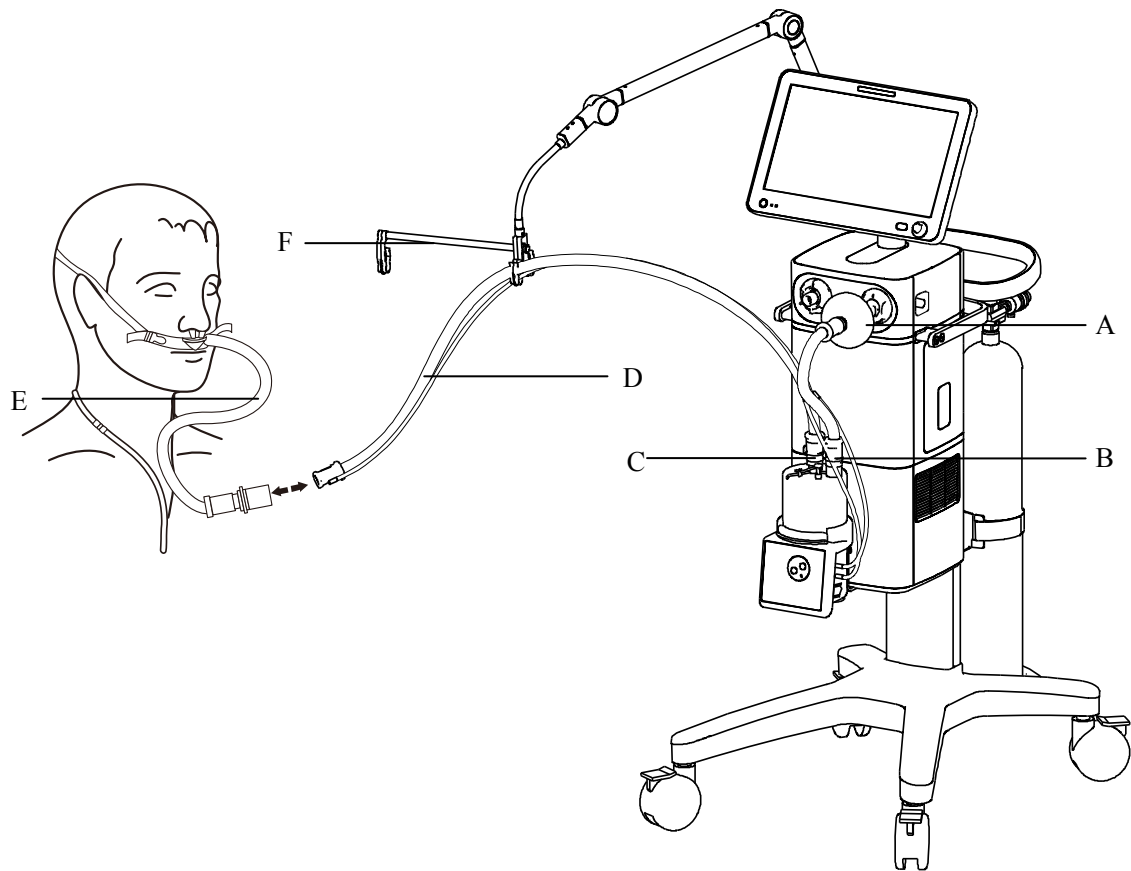

- | | | |
|---|---------------------|----------------------|
| A. Inspiratory Filter | B. Humidifier inlet | C. Humidifier outlet |
| D. Patient tubing with heating function | E. Nasal cannula | F. Support arm hook |

1. Mount the filter onto the inspiratory port.
2. Connect the inspiratory filter to the humidifier inlet via the tube.
3. Connect the humidifier outlet to the nasal cannula via the tube with heating function.
4. The expiratory port is not connected with a tube.
5. Place the tubes onto the support arm hook.

10.14.2 Switching on O₂ Therapy

WARNING

- The device must only be used under the supervision of qualified medical staff, so that help is immediately available if malfunctions occur or the patient has insufficient spontaneous breathing.

1. Select the [Standby] key to enter Standby status after confirmation.
2. Select [O₂ Therapy] in the Standby status to enter O₂ therapy screen.
3. Set [Flow] and [O₂%] to appropriate values as required.

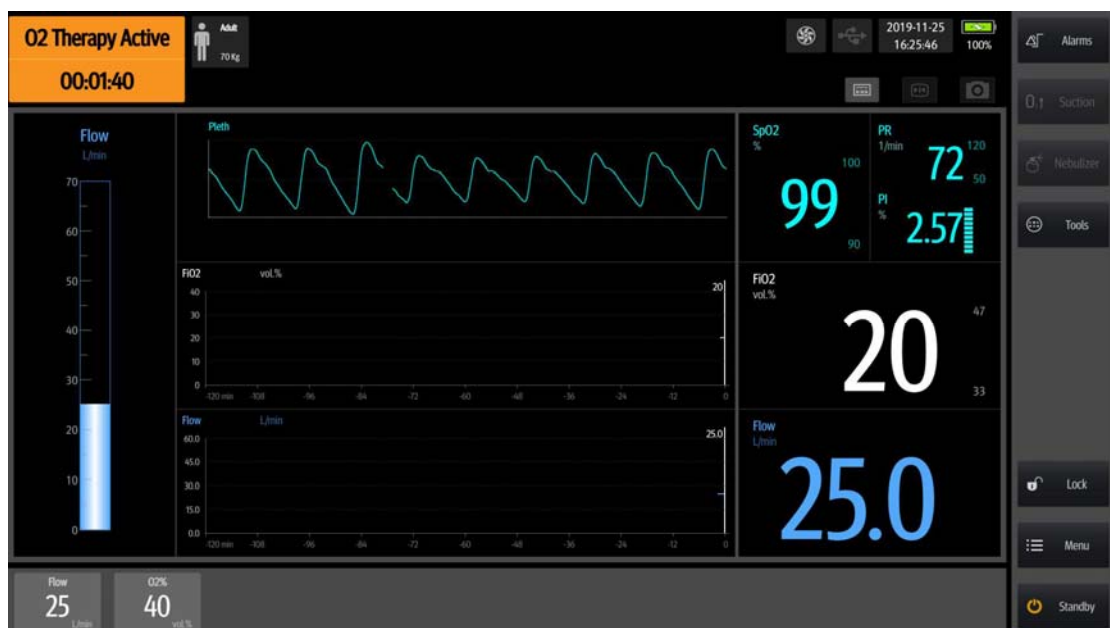

Relationship between settable maximum O₂% and Flow in O₂ therapy mode

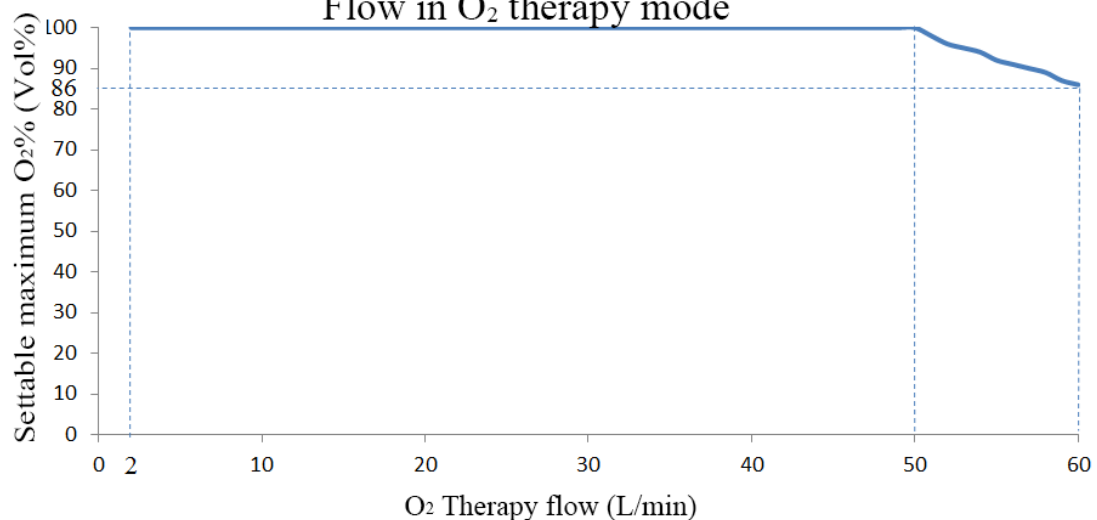



The relationship between the settable maximum O ₂ % and Flow during the O ₂ therapy	
Oxygen therapy flow rate (L/min)	Settable maximum O ₂ concentration (Vol.%)
2-50	100
51	98
52	96
53	95
54	94
55	92
56	91
57	90
58	89
59	87
60	86

10.14.3 O₂ Therapy Timing/Timer

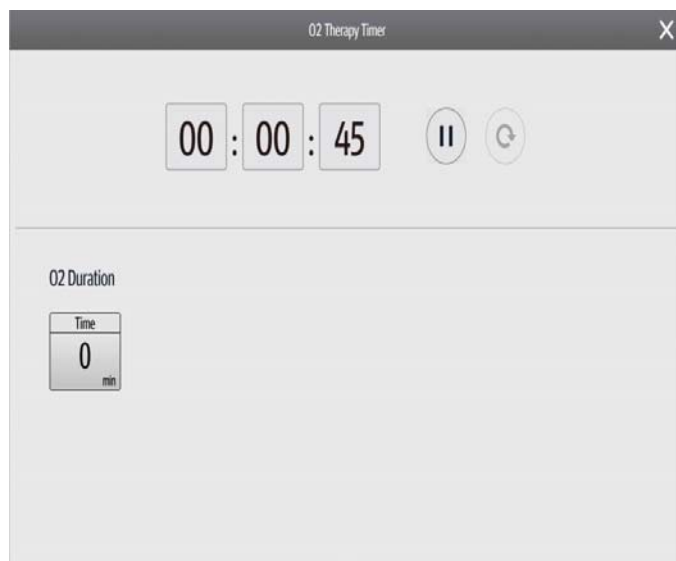
Select the O₂ Therapy Timing/Timer area in the top left corner to access the window as shown below



Timing can be stopped or started by pressing the  or  keys. The time displayed on the timer can be reset to zero by selecting the  key.

The timer can be started by inputting the required time in minutes in [O₂ Duration]. When the time expires, the system will emit a noise, but the oxygen supply will not be suspended.

10.14.4 Switching off O₂ Therapy

During O₂ therapy, select the [Standby] key to enter Standby status after confirmation, so as to switch off the O₂ therapy function.



10.15 Auxiliary Pressure

Auxiliary pressure function is external pressure monitoring function provided by ventilator. By connecting the external pressure sampling accessory with ventilator's auxiliary pressure measurement connector, the ventilator can monitor and display different pressure. Refer to the auxiliary pressure accessory accompanying operator's manual for connection and usage.

10.15.1 Turn on Auxiliary Pressure

1. Select [Tools] → [Advanced] → [Paux] to enter the auxiliary pressure screen.
2. Select [Paux1] or [Paux2] as required, and set [Paux1(Pes)] or [Paux2] to

 (OFF) or  (ON) in the opened interface.

- ◆ When [Paux1(Pes)] is set to  (ON), the ventilator provides the monitored parameters (PtpI, PtpE, ΔPtp, PesI, PesE, Δpes, PTPes, PTPes/min), loops (Pes-Volume, Ptp-Volume), waveforms (Pes, Ptp) and trend data of the monitored parameters.
- ◆ When [Paux2] is set to  (ON), the ventilator provides the monitored parameters (Paux2I, Psux2E), waveforms (Paux2) and trend data of the monitored parameters.
- ◆ When both [Paux1(Pes)] and [Paux2] are set to  (ON), in addition to the above data, the ventilator also provides Paux2-Paux1 waveform.

10.15.2 Auxiliary Pressure Zeroing

1. Select [Tools] → [Advanced] → [Paux] to enter the auxiliary pressure screen.
2. Select [Paux1] or [Paux2] as required, and select [Start] in the opened interface to initiate the auxiliary pressure zeroing.

FOR YOUR NOTES

11 Alarms

11.1 Introduction

Alarms, triggered by a vital sign that appears abnormal or by technical problems of the ventilator, are indicated to the user by visual and audible alarm indications.

NOTE

- **When the ventilator is started, the system detects whether audible alarm tones and alarm lamp function normally. If yes, the alarm lamp flashes yellow and red successively, and the speaker and the buzzer give check tones. If not, do not use the equipment and contact us immediately.**
 - **When multiple alarms of different priorities occur simultaneously, the ventilator selects the alarm of the highest priority and gives visual and audible alarm indications accordingly.**
 - **If more than one alarms are triggered at the same level, alarm messages will be shown by the sequence of alarms triggered.**
 - **The ventilator restore the latest configuration if restarts within 60 seconds after the power failure. And it will restore the user configuration rather than the latest configuration if restarts 120 seconds later after the power failure. The ventilator may load either the latest configuration or the user configuration if restarts from 60-120 seconds after the power failure.**
 - **If the equipment power failure lasts for not more than 30 s, the alarm settings prior to the power failure are restored when the equipment is powered on again.**
-

WARNING

- **A potential hazard can exist if different alarm presets are used for the same or similar equipment in any single area, e.g. an intensive care unit or cardiac operating room.**
-
-

11.2 Alarm Categories

By nature, the ventilator's alarms fall into three categories: physiological alarms, technical alarms and prompt messages.

1. Physiological alarms

Physiological alarms, also called patient status alarms, are triggered by a monitored parameter value that violates set alarm limits or an abnormal patient condition. Physiological alarm messages are displayed in the alarm message field.

2. Technical alarms

Technical alarms, also called system status alarms, are triggered by a device malfunction or a patient data distortion due to proper operation or mechanical problems. Technical alarm messages are displayed in the alarm message field.

3. Prompt messages

As a matter of fact, prompt messages are not alarm messages. Apart from the physiological and technical alarm messages, the ventilator will show some messages telling the system status. Messages of this kind are included into the prompt message category and are usually displayed in the prompt message field.

11.3 Alarm Priority Levels

By severity, the ventilator's alarms fall into three categories: high priority alarms, medium priority alarms and low priority alarms.

The priorities for all alarms are preset before the ventilator leaves the factory and are not user adjustable.

11.4 Alarm Signals

When an alarm occurs, the ventilator will indicate it to the user through visual or audible alarm signals.

- Alarm Lamp
- Audible alarm
- Alarm Messages
- Flashing numeric.

Among them, the alarm lamp, audible alarm tones and alarm messages distinguish the priority of the alarm in different ways.

11.4.1 Alarm Lamp

If a technical alarm or physiological alarm occurs, the alarm lamp will flash. The flashing color and frequency match the alarm priority as follows:

- High priority alarms: the lamp quickly flashes red.
- Medium priority alarms: the lamp slowly flashes yellow.
- Low priority alarms: the lamp turns yellow without flashing.

11.4.2 Audible Alarm

The ventilator uses different alarm tone patterns to match the alarm priority:

- High priority alarms: broadcasts the high priority alarm tone.
- Medium priority alarms: broadcasts the medium priority alarm tone.
- Low priority alarms: broadcasts the low priority alarm tone.

A-weighted sound pressure level of audible alarm signals:

- Position of the operator: 1-meter in front of and 1.5-meter above the ventilator.
- A-weighted sound pressure level: not less than 45dB and not greater than 85 dB. The high priority alarm volume is not less than 60dB at the default alarm volume level.

11.4.3 Alarm Messages

When an alarm occurs, an alarm message will appear in the ventilator's alarm message field.

The alarm message uses a different background color to match the alarm priority:

- High priority alarms: red
- Medium priority alarms: yellow
- Low priority alarms: yellow

The exclamatory marks (!) before the alarm message match the alarm priority as follows:





- High priority alarms: ! ! !
- Medium priority alarms: ! !
- Low priority alarms: !

11.4.4 Flashing Alarm Numeric

If an alarm triggered by an alarm limit violation occurs, the numeric of the measured parameter in alarm will flash at a specified frequency.

11.4.5 Alarm Status Symbol

Apart from the aforementioned alarm indicators, the ventilator still uses the following symbols telling the alarm status:

-  **115 s**: indicates that the alarm audio is paused and the alarm system is in **AUDIO PAUSED** mode.
- : indicates multiple alarm messages when this icon is displayed before alarm messages to show the number of alarms. The alarm message uses a different background color to match the alarm priority. Red background means that the highest priority of the multiple alarm messages is high while yellow background means that the highest priority of the multiple alarm messages is medium. You can view active alarms by selecting the alarm message field.
- : indicates that there is inactivated alarm(s) for which the alarm trigger condition has disappeared. Press this icon to view the most recent inactivated alarms (up to 9 alarm messages are displayed) in the opened interface. You can also clear the most recent alarms with the [**Reset**] key.
- : indicates that the alarm of a parameter is closed and the alarm signal is in the **ALARM OFF** mode.

11.5 Alarm Volume Settings

Set Alarm Volume:

1. Select [**Alarm**] key→[**Audio**].
2. Set [**Alarm Volume**]: X-10, with X being the minimum alarm volume and 10 the maximum alarm volume. If there are no currently active alarms, you can also select [**Test**]. The system will emit a low-priority alarm tone once based on the selected alarm volume.

Set minimum alarm volume:

1. Select [**Menu**]→[**System**]→Enter system password→[**Setup**].
2. Set [**Minimum Alarm Volume**] to an appropriate value.

WARNING

- Do not rely exclusively on the audible alarm system when using the ventilator. Adjustment of alarm volume to a low level may result in a hazard to the patient. Always keep the patient under close surveillance.
-

11.6 Set Alarm Limits

CAUTION

- In the case that high pressure alarm limit of 60 cmH₂O is not required under clinical conditions, setting the high pressure alarm limit to 60 cmH₂O or less is recommended so as to extend the service life of the spare air supply and the battery.
-

NOTE

- An alarm is triggered when the parameter value is higher than the high limit or lower than the low limit.
 - When using the ventilator, always keep an eye on whether the alarm limits of a specific parameter are set to the appropriate values.
-

Select [Alarm] → [Vent Limits] or [Module Limits] to set ventilation or module-related alarm limits.

11.6.1 Auto Alarm Limits

Select [Alarm] → [Vent Limits] → [Auto Alarm Limits], the ventilator will update the parameter alarm limits based on the monitored value. The relationship is shown in the table below.

Alarm Limit	Adjust Formula
Paw High Limit	Average peak pressure+10cmH ₂ O or 35cmH ₂ O, whichever is greater
Low airway pressure limit	PEEP + 4 cmH ₂ O
MV High limit	1.5×MVe monitored value
MV Low limit	0.5×MVe monitored value
TV High limit	1.5×TVe average value
TV Low limit	0.5×TVe average value
ftot High Limit	1.4×Total frequency monitoring value, not more than 160/min
ftot Low limit	0.6×ftot monitored value
Apnea time	15 s

The value used for average uses the monitoring value of the last eight ventilation cycles or the monitoring value in one minute, whichever is smaller.

If the calculated alarm limit is more than the high threshold of setting range or less than the low threshold, the corresponding threshold is used as the auto alarm limit.

11.7 AUDIO PAUSED

11.7.1 Set AUDIO PAUSED

Press the  key to pause the alarm audio of currently active alarms for 120 seconds.

WARNING

- **Pay close attention to the patient and ventilator to ensure no alarm messages are ignored during the period of AUDIO PAUSED. Possible patient or equipment hazard may be produced if the alarm condition continues while no action is taken.**

NOTE

- **Under AUDIO PAUSED status, all the alarm indicators work normally except audible alarm tones.**
- **Under AUDIO PAUSED status, if a new technical or physiological alarm occurs, the AUDIO PAUSED status terminates automatically and audible alarm tones start again.**
- **When the 120 s countdown time is up, the AUDIO PAUSED status terminates and audible alarm tones start again.**

11.7.2 Terminate AUDIO PAUSED

Under the alarm **AUDIO PAUSED** status, press the  key or trigger a new alarm will terminate the **AUDIO PAUSED** status and restore audible alarm tones. The **AUDIO PAUSED** icon and 120-second countdown will disappear from the screen simultaneously.

11.8 Current Alarm

When there are currently active alarms, if the number is displayed before alarm messages, it indicates there are multiple all active alarm messages. By selecting the alarm message field, you can view active alarm messages, alarm occurrence time and alarm priority in the opened alarm window. Up to 9 alarm messages are displayed in the current alarm window.

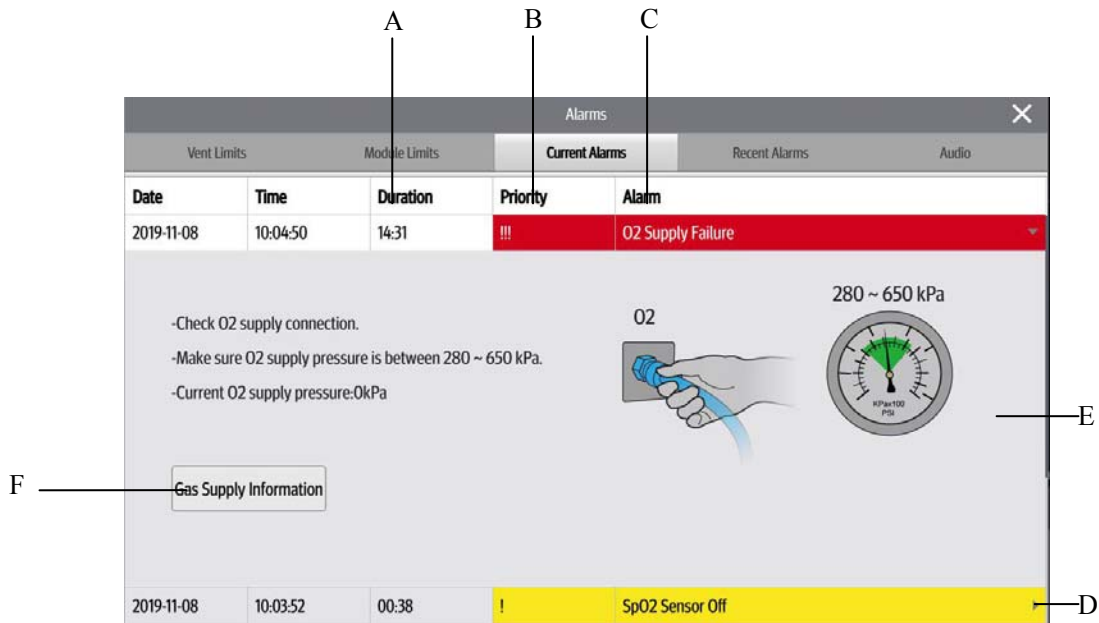

- A. Duration of alarm/prompt message
- B. Alarm priority levels
- C. Alarm/prompt message
- D. Help information soft key

Press this soft key to display Help Information in the window that appears. Press this soft key again to close the Help Information window.

- E. Help information
- F. Associated information

Select the key to open the corresponding settings menu.

11.9 Alarm Chain

An alarm chain refers to a set of alarms in which a principal alarm triggers one or more subordinate alarms. When a principal alarm is activated, the alarm information area on the main screen will only display the principal alarm, and will not show the subordinate alarms. When more than one principal alarm is activated, they will be listed in the current alarm window in chronological order based on their activation times, with their subordinate alarms displayed below them.

Alarms						
Vent Limits		Module Limits		Current Alarms	Recent Alarms	Audio
Date	Time	Duration	Priority	Alarm		
2019-11-08	10:05:26	00:03	!!!	Tube Disconnected?		
2019-11-08	10:04:50	00:39	!!!	MVe Too Low		
2019-11-08	10:03:52	01:37	!	SpO2 Sensor Off		
2019-11-08	09:49:59	15:30	!!!	O2 Supply Failure		

- A. Principal alarm
- B. Subordinate alarms

11.10 Recent Alarm

The icon will appear if there is inactivated alarm (alarms) for which the alarm trigger condition has disappeared. By pressing the icon, you can view the recent inactivated alarms in the opened window (up to 9 alarm messages are displayed). You can also clear the recent inactivated alarms by pressing the **[Reset]** key.

11.11 ALARM OFF

When the alarm limit is set as [OFF] or alarm is disabled, the system will display an

ALARM OFF icon  showing the parameter alarm limits, and corresponding physiological alarms will be closed. Namely, the alarm message, alarm lamp, audible alarm tones, and flashing alarm numeric for this physiological alarm will be all switched off.



WARNING

- Switching off alarms can endanger the patient. Handle with care.
-

11.12 Alarm Tests

11.12.1 Battery in Use

1. Connect the ventilator to AC power and push the hard key  to switch on.
2. Disconnect the AC power after the system starts up.
3. Verify that the [**Battery in Use**] alarm is activated and the ventilator is powered by batteries.
4. Reconnect the AC power.
5. Verify that the alarm resets and the ventilator is again powered by AC.

11.12.2 Loss of Power

1. Connect the ventilator to AC power and push the hard key  to switch on.
2. After the system starts up, disconnect the external power supply when the battery is fully charged.
3. Connect a test lung to the ventilator and start normal ventilation.
4. Ventilation time is approximately 1.5 hours for a ventilator configured with one battery, and approximately 3 hours for a ventilator configured with two batteries. When the battery power is depleted, the [**System will shut off soon. Connect with External Power Supply.**] alarm is activated.
5. Reconnect the external power supply.
6. Verify that the alarm resets and the ventilator is again powered by external power supply.

11.12.3 Paw Too High

1. After the ventilator system starts up normally, connect a test lung to the ventilator and start ventilation.
2. Set Paw high alarm limit to current Peak+5 cmH₂O.
3. Squeeze the test lung hard during inspiration.
4. Verify that the [**Paw Too High**] alarm is activated, the ventilator cycles into expiration, and airway pressure falls to PEEP level.

11.12.4 Paw Too Low

1. After the ventilator system starts up normally, connect a test lung to the ventilator and start ventilation.
2. Set Paw low alarm limit to current Peak+5 cmH₂O.
3. Check whether the [**Paw Too Low**] alarm is activated.

11.12.5 TVe Too Low

1. After the ventilator system starts up normally, connect a test lung to the ventilator and start ventilation.
2. Set the TV low alarm limit to be greater than the current TVe. Verify that the [**TVe Too Low**] alarm is activated.

11.12.6 TVe Too High

1. After the ventilator system starts up normally, connect a test lung to the ventilator and start ventilation.
2. Set the TV high alarm limit to be less than the current TVe. Verify that the [**TVe Too High**] alarm is activated.

11.12.7 MV Too Low

1. After the ventilator system starts up normally, connect a test lung to the ventilator and start ventilation.
2. Set the MV low alarm limit to be greater than the current MV. Verify that the [**MV Too Low**] alarm is activated.

11.12.8 Air Supply Pressure Low

1. Connect the ventilator to the gas supply.
2. Close the gas supply to determine whether the [**Air Supply Pressure Low**] alarm is activated.

11.12.9 O₂ Supply Pressure Low

1. Connect the ventilator to the O₂ supply.
2. Close the oxygen supply and check whether the [**O₂ Pressure Too Low**] alarm is activated.

11.12.10 PEEP Too Low

1. Remove the expiration valve membrane and install the expiration valve.

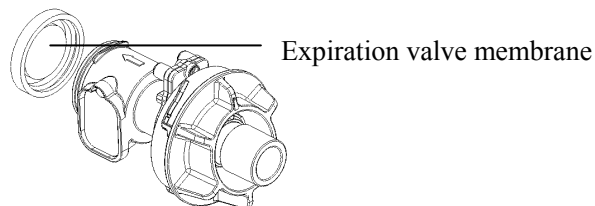

2. After the ventilator system starts up normally, connect a test lung to the ventilator and start ventilation.
3. Set PEEP to 5 cmH₂O. Verify that the [**PEEP Too Low**] alarm is activated.

11.12.11 Airway Obstructed

1. After the ventilator system starts up normally, connect a test lung to the ventilator and set the ventilator to pressure mode to start ventilation.
2. Disconnect the Y-piece tube from the test lung and plug the Y-piece tube with the leak test plug.
3. Verify that the [**Airway Obstructed?**] alarm is activated after several breathing cycles.
4. Connect Y piece tube with the test lung and verify this alarm is reset automatically.

11.12.12 FiO₂ Too High

1. Correctly connect the oxygen supply and close the air supply (If the ventilator is configured with backup air supply, please turn off the backup air supply. For details, refer to *5.7 Set Gas Supply*).
2. Connect a test lung to the ventilator, set FiO₂ to 60%, and start ventilation.
3. Verify that the [**FiO₂ Too High**] alarm is activated.

NOTE

- Please resume the setting of the backup air supply after the test.
-

11.12.13 FiO₂ Too Low

1. Make correct connection to the air supply and close the oxygen supply.
2. Connect a test lung to the ventilator, set FiO₂ to 60%, and start ventilation.
3. Verify that the [**FiO₂ Too Low**] alarm is activated.

11.12.14 EtCO₂ Too High

1. Connect a test lung to the ventilator and start ventilation.
2. Connect the CO₂ test module and set the CO₂ test module to operating mode.
3. After CO₂ warm-up is completed and the CO₂ module enters operating mode, deliver 3 % to 7 % of CO₂ standard gas to the sampling port of sidestream CO₂ module or the airway adapter of mainstream CO₂ module. Set the EtCO₂ high alarm limit to be less than the standard gas concentration.
4. Verify that the [**EtCO₂ Too High**] alarm is activated.

11.12.15 EtCO₂ Too Low

1. Connect the CO₂ test module and set the CO₂ test module to operating mode.
2. Connect a test lung to the ventilator and start ventilation.
3. After CO₂ warm-up is completed and the CO₂ module enters operating mode, deliver 3 % to 7 % of CO₂ standard gas to the sampling port of sidestream CO₂ module or the airway adapter of mainstream CO₂ module. Set the EtCO₂ low alarm limit to be greater than the standard gas concentration.
4. Verify that the [**EtCO₂ Too Low**] alarm is activated.

11.12.16 SpO₂ Too High

1. Connect a test lung to the ventilator and start ventilation.
2. Connect the SpO₂ sensor and activate the SpO₂ monitoring function.
3. Connect the SpO₂ sensor to the index finger, set the SpO₂ Desat alarm limit as 0%, set the SpO₂ low alarm limit as 0% and the SpO₂ high alarm limit 2%.
4. Verify that the [**SpO₂ Too High**] alarm is activated.

11.12.17 SpO₂ Too Low

1. Connect a test lung to the ventilator and start ventilation.
2. Connect the SpO₂ sensor and activate the SpO₂ monitoring function.
3. Connect the SpO₂ sensor to the index finger, set the SpO₂ high alarm limit as 100% and the SpO₂ low alarm limit 98%.
4. Grasp the wrist with another hand to press the pulse until the SpO₂ reading is below 98 %, and verify that the [**SpO₂ Too Low**] alarm is activated.

11.12.18 SpO₂ Desat

1. Connect a test lung to the ventilator and start ventilation.
2. Connect the SpO₂ sensor and activate the SpO₂ monitoring function.
3. Connect the SpO₂ sensor to the index finger and set the SpO₂ high alarm limit as 100%, the SpO₂ low alarm limit 98%, and the SpO₂ Desat 98%.
4. Grasp the wrist with another hand to press the pulse until the SpO₂ reading is below 98 %, and verify that the [**SpO₂ Desat**] alarm is activated.

11.12.19 PR Too High

1. Connect a test lung to the ventilator and start ventilation.
2. Connect the SpO₂ sensor and activate the SpO₂ monitoring function.
3. Connect the SpO₂ sensor to the index finger and set the PR high alarm limit as 15 1/min.
4. Verify that the [**PR Too High**] alarm is activated.

11.12.20 PR Too LOW

1. Connect a test lung to the ventilator and start ventilation.
2. Connect the SpO₂ sensor and activate the SpO₂ monitoring function.
3. Connect the SpO₂ sensor to the index finger, and set the PR high alarm limit as 300 1/min and the PR low alarm limit 298 1/min.
4. Verify that the [**PR Too Low**] alarm is activated.

11.13 Nurse Call

The ventilator provides nurse call function that enables the ventilator to output nurse call signals to the nurse call system when an alarm meeting the user set requirements occurs.

The nurse call function is activated only when:

1. The nurse call function is switched on;
2. An alarm which meets the user set requirements occurs;
3. The ventilator is not in **AUDIO PAUSED** status.

Follow these steps to set nurse call:

1. Select [**Menu**] → [**System**] → Enter system settings password → [**Interface**] → [**Nurse Call**].
2. Select [**Switch**] and toggle between [**ON**] and [**OFF**].
 - [**ON**]: to switch on the nurse call function.
 - [**OFF**]: to switch the nurse call function off.
3. Set [**Signal type**].
 - [**Pulse**]: indicates that the nurse call signals outputted are pulse signals lasting for one second. When multiple alarms occur simultaneously, only one pulse signal is outputted. If a new alarm occurs when the ongoing alarm is not cleared yet, a new pulse signal will be outputted.
 - [**Continuous**]: indicates that the nurse call signal lasts until the alarm ends, i.e. the duration of a nurse call signal equals to that of the alarm.
4. Select [**Contact Type**].
 - [**Normally Open**]: to trigger nurse call with normally open signal .
 - [**Normally Closed**]: to trigger nurse call with normally closed signal.
5. Select [**Alarm Level**] and select levels of alarm that will trigger nurse call signal.
6. Select [**Alarm Type**] and select types of alarm that will trigger nurse call signal.

If no setting is made for [**Alarm Level**] or [**Alarm Type**], nurse call signals will not be triggered no matter what alarm occurs.

WARNING

- **Do not rely exclusively on the nurse call system for alarm notification. Remember that the most reliable alarm notification combines audible and visual alarm indications with the patient's clinical condition.**
-

 **WARNING**

- **Use the specified nurse call cable when connecting with the hospital's nurse call system through the nurse call connection port. Failure to do so may burn the machine and produce electric shock hazard.**
 - **Inspect the ventilator alarm signals periodically when using the nurse call function.**
-

11.14 When an Alarm Occurs

When an alarm occurs, do as follows:

1. Check the patient's condition.
2. Determine the alarming parameter or alarm category.
3. Identify the alarm source.
4. Take proper actions to eliminate the alarm condition.
5. Make sure the alarm condition is corrected.

For details about how to troubleshoot alarms, refer to *D Alarm Messages*.

 **WARNING**

- **To prevent possible patient injury when alarms are active, ensure that the patient receives adequate ventilation. Identify and remove the cause of the alarms. Readjust the alarm limits only when they are inappropriately set for the current conditions.**
-
-

 **CAUTION**

- **Contact the Customer Service Department if the alarm persists without obvious cause.**
-

12 Cleaning and Disinfection

WARNING

- Obey applicable safety precautions.
 - Read the material safety data sheet for each cleaning agent.
 - Read the operation and service instructions for all disinfection equipment.
 - Wear gloves and safety glasses. A damaged O₂ sensor can leak and cause burns (contains potassium hydroxide).
 - Reuse of undisinfected reusable accessories or components may cause cross-contamination.
 - To prevent leaks, avoid damaging any component in case of disassembling and reassembling the breathing system. Ensure the correct installation of the system. Make sure of the applicability and correctness of the cleaning and disinfection methods.
 - Disassemble and reassemble the breathing system as described in this manual. If you need further disassembly and reassembly, contact us. Improper disassembling and reassembling may cause breathing system to leak and compromise normal system use.
 - Seeping liquid into the control assembly can damage the equipment or cause personal injury. When cleaning the housing, ensure that no liquid flows into the control assemblies and always disconnect the equipment from the AC mains. Reconnect the AC mains after the cleaned parts are fully dry.
 - To avoid sticky residuals, do not use talc, zinc stearate, calcium carbonate, corn starch, or equivalent materials. These materials can go into the patient's lungs and airways and cause irritation or injury.
-
-

CAUTION

- To prevent patient exposure to disinfection agents and to prevent premature deterioration of parts, use the cleaning and disinfection methods and agents recommended in this section.
 - To reduce the risk of electrical shock, disconnect electrical power from the ventilator before cleaning and disinfection.
-
-

NOTE

- **Clean and disinfect the equipment as required before it is put into use for the first time. Refer to this chapter for the cleaning and disinfection methods.**
 - **To help prevent damage, refer to the manufacturer's data if you have questions about a cleaning agent.**
 - **Do not use organic, halogenated, or petroleum based solvents, anesthetic agents, glass cleaners, acetone, or other harsh cleaning agents.**
 - **Do not use abrasive cleaning agents (such as steel wool, silver polish, or cleaner).**
 - **Keep all liquids away from electronic parts.**
 - **Do not permit liquid to go into the equipment housings.**
 - **Cleaning solutions must have a pH of 7.0 to 10.5.**
 - **After cleaning and disinfection is completed, run System Check before using the equipment. Use the equipment only when System Check is passed.**
 - **After cleaning and disinfection is completed, check whether there is any damage to or cracks on the components (e.g., expiratory valve membrane). If so, replace the component in a timely manner.**
-

12.1 Methods for Cleaning and Disinfection

Some of the ventilator's parts can be cleaned and disinfected. Different parts of the ventilator should be disinfected using different methods. You need to select the appropriate method to clean and disinfect the parts based on the actual situations to avoid cross-contamination between the ventilator user and the patient.

This table is our recommended cleaning and disinfection methods for the ventilator parts, including use for the first time and use after many times.

Parts	Recommended frequency Interval	Cleaning		Disinfection			
		① Wipe	② Immersion	A Wipe	B Immersion	C Autoclaving	D Ultraviolet radiation
Ventilator Housing							
External ventilator surface (including housing, plug-in module housing, backup air supply module housing, power cord and gas supply hose).	Each patient	①		A or D			
Trolley and support arm	Each patient	①		A or D			
Touch screen	Each patient	①		A or D			
Fan dust filter	Every four weeks/as necessary*	②		B			
Main Unit Air Outlet Dust Filter	Every four weeks/as necessary*	②		B			
Air intake dust filter	Every four weeks/as necessary*	②		B			
Ventilator inspiration safety valve assembly							
Inspiration safety valve assembly	as necessary*	②		B or C			
Ventilator expiration valve assembly							
Expiration valve membrane (silicone)	Each patient/weekly	②		B or C			
Expiration valve assembly (except membrane)	Each patient/weekly	②		B or C			

Ventilator patient tubing (reusable)			
Patient tubing (including water trap, Y piece and adapter)	Each patient/weekly	②	B or C
Other			
CO ₂ Module	Each patient/weekly	Refer to the cleaning and disinfection methods provided by the mainstream CO ₂ vendor.	
SpO ₂ Sensor	Each patient/weekly	Refer to the cleaning and disinfection methods provided by the attached package insert.	
SpO ₂ Sensor Cable	Each patient/weekly	Refer to the cleaning and disinfection methods provided by the attached package insert.	
Nebulizer	Each patient/weekly	Refer to the cleaning and disinfection methods provided by the nebulizer vendor.	
Humidifier	Each patient/weekly	Refer to the cleaning and disinfection methods provided by the humidifier vendor.	
<p>Cleaning Methods:</p> <p>① Wipe: wipe with a damp cloth immersed in alkaline detergent (soapy water, etc.) or alcohol solution, and then wipe off the remaining detergent with a dry lint-free cloth.</p> <p>② Immersion: flush with water first and then immerse it in alkaline detergent (soapy water, etc., water temperature of 40°C recommended) for approximately three minutes. Finally, clean with water and dry completely.</p> <p>Methods for Disinfection:</p> <p>A: Wipe: wipe with a damp cloth immersed in medium- or high-efficiency detergent and then wipe off the remaining detergent with a dry lint free cloth.</p> <p>B: Immersion: immerse it in medium- or high-efficiency detergent for more than 30 minutes (recommended time). Then clean with water and dry completely.</p> <p>C: Steam autoclave at 134°C for 10 to 20 minutes (recommended time).</p> <p>D: Ultraviolet radiation for 30 to 60 minutes (recommended time).</p>			

As necessary*: shorten the cleaning and disinfection intervals if the equipment is used in dusty environment to ensure that the equipment surface is not covered by dust. Clean and disinfect the inspiration safety valve assembly only when the patient's exhaled gas may contaminate the inspiratory limb. For disassembling and installation methods, refer to **12.2.2**.

The table below lists the cleaning and disinfecting agents and autoclaving process that may be used on the ventilator.

Name	Type
Ethanol (75%)	Moderately efficient disinfectant
Isopropanol (70%)	Moderately efficient disinfectant
Glutaraldehyde (2%)	Highly efficient disinfectant
Ortho-Phthalaldehyde disinfectant (such as Cidex®OPA)	Highly efficient disinfectant
Soap water (pH value of 7.0~10.5)	Rinsing agent
Clean water	Rinsing agent
Steam autoclave*	Highly efficient disinfection

Steam autoclave*: The recommended temperature of this disinfection method is 134°C (273°F).

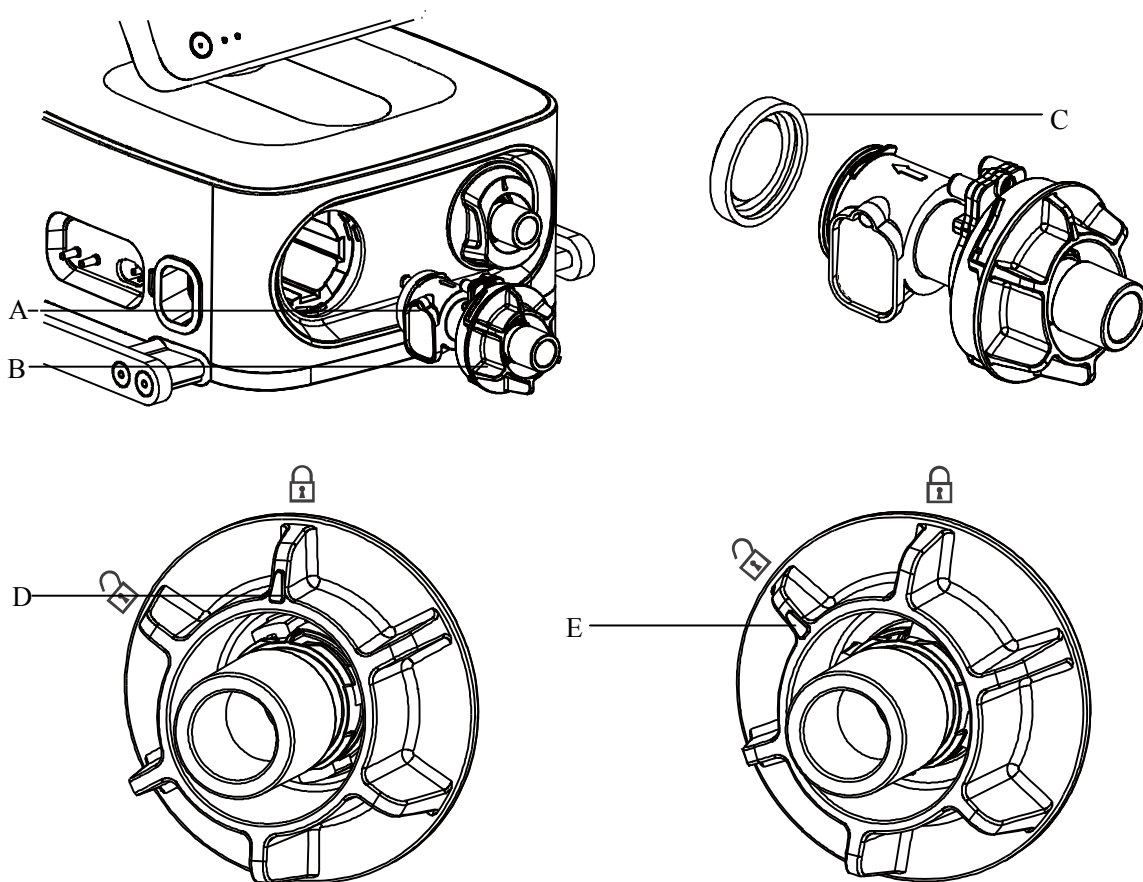

12.2 Disassemble the Ventilator's Cleanable and Disinfectable Parts

12.2.1 Expiration Valve Assembly and Membrane







-
- A. Expiration valve assembly
 - B. Expiration valve handwheel
 - C. Expiration valve membrane
 - D. Locked state of the expiration valve
 - E. Unlocked state of the expiration valve

■ To disassemble:

1. Rotate the expiration valve handwheel until the indicating arrow  on the handwheel is aligned with the  position. Then pull the expiration valve assembly out of the assembly horizontally.
2. Remove the expiration valve membrane.

■ To install:

1. Install the expiration valve membrane onto the expiration valve assembly.
2. Ensure that the indicating arrow  on the handwheel is aligned with the  position. Push the expiratory valve assembly into the corresponding connector on the ventilator horizontally until it is fully inserted. Then rotate the expiratory valve handwheel clockwise (and press the handwheel in the direction the expiratory valve is installed) until the indicating arrow  on the handwheel is aligned with the  position.

12.2.2 Inspiration safety valve assembly

12.2.2.1 Inspiration safety valve assembly

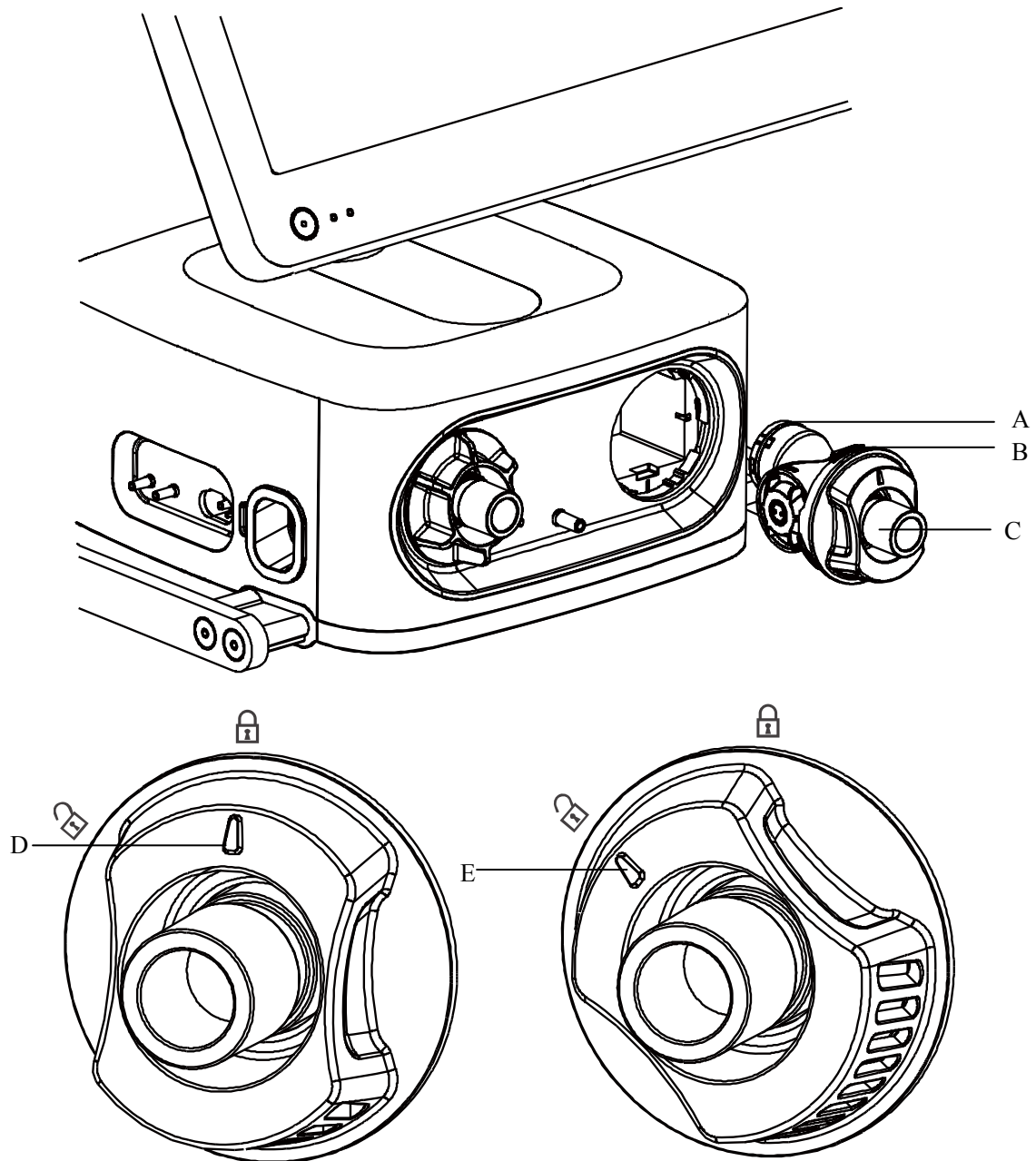

A. Sealing ring



B. Safety valve assembly

C. Safety valve handwheel





D. Locked state of the inspiration safety valve

E. Unlocked state of the inspiration safety valve

- To disassemble:

Ensure the ventilator in standby or off status. Rotate the inspiratory safety valve knob anticlockwise until the indicating arrow  on the safety valve knob is aligned with the  position. Then pull out the inspiratory safety valve assembly horizontally. Check if the sealing ring at the end of the inspiration safety valve is disconnected. If it is disconnected, re-install the sealing ring onto the inspiration safety valve.

- To install:

Push the inspiratory safety valve assembly into the corresponding connector on the ventilator horizontally until it is fully inserted. Ensure that the indicating arrow  on the knob is aligned with the  position. Then rotate the inspiratory safety valve knob clockwise (and press the knob in the direction the inspiratory safety valve is installed) until the indicating arrow  on the knob is aligned with the  position.

12.2.2.2 Inspiration safety valve membrane

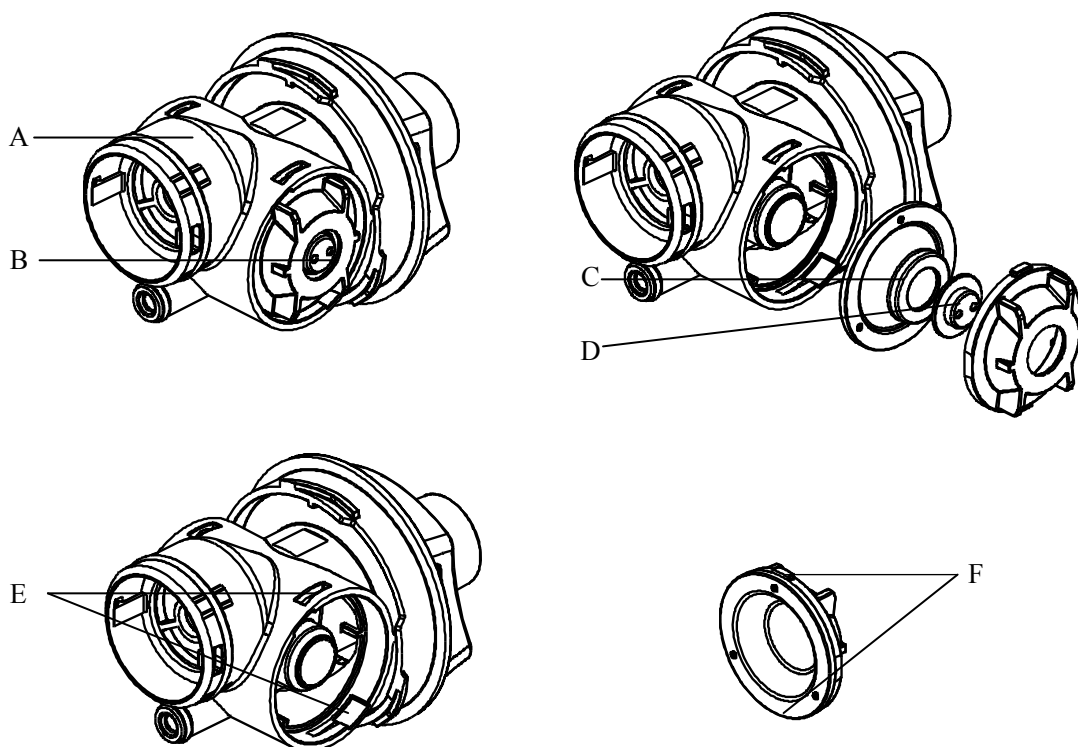

- | | | |
|-----------------------------------|--------------------------------|--------------------------|
| A. Safety valve body | B. Membrane fixing knob | C. Safety valve membrane |
| D. Membrane support | E. Groove of safety valve body | |
| F. Guides on membrane fixing knob | | |

■ To disassemble:

1. Face the membrane fixing knob and rotate the membrane fixing knob counter-clockwise to the end position. When the knob guides reach the grooves of safety valve body, pull out the membrane fixing knob.
2. Remove the safety valve membrane.

■ To install:

1. Assemble the safety valve membrane to the membrane fixing knob. The 3 holes on the membrane match the 3 posts on the membrane fixing knob, as shown below. Ensure the metal side of the membrane support can be seen through the hole on the membrane fixing knob.

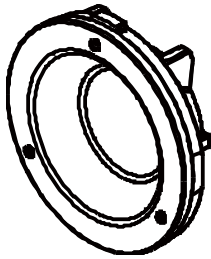

2. Align the guides on membrane fixing knob with the grooves of safety valve body. Insert the membrane fixing knob, press it tightly and rotate it clockwise to the right end position.

12.2.3 HEPA Filter Components and Air Intake Dust Filter

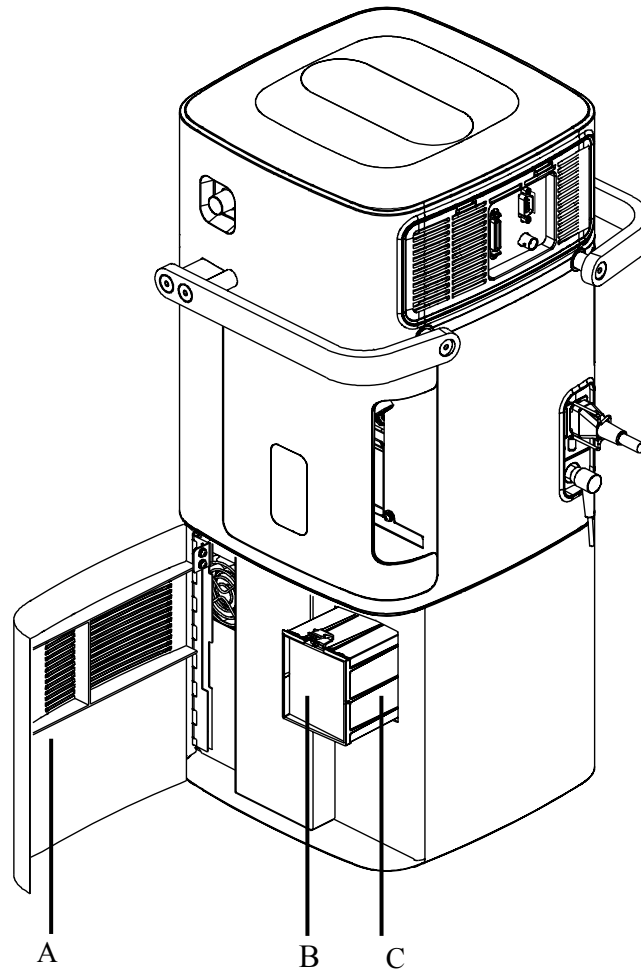

- A. Back air supply maintenance door B. Air intake dust filter C. HEPA

-
- To disassemble:
 1. Open backup air supply maintenance door.
 2. Pull the latch over the HEPA filter to remove. If it is necessary to remove the air intake dust filter, pinch the dust filter with two fingers and take it out.
 - To install:
 1. Align the HEPA filter with the corresponding slot, and push in the direction the HEPA filter is installed. Fasten the HEPA filter latch.
 2. Check whether the key placement above HEPA has been installed correctly.
 3. Close backup air supply maintenance door.

NOTE

-
- **Install the specified HEPA filter and air intake dust filter.**
-

CAUTION

-
- **Do not operate the ventilator if the ventilator is not equipped with an HEPA filter when backup air supply is used as the air supply. Otherwise, the inspiration end of the device and patient tubing will be contaminated.**
-

12.2.4 Back air supply cooling fan dust filter

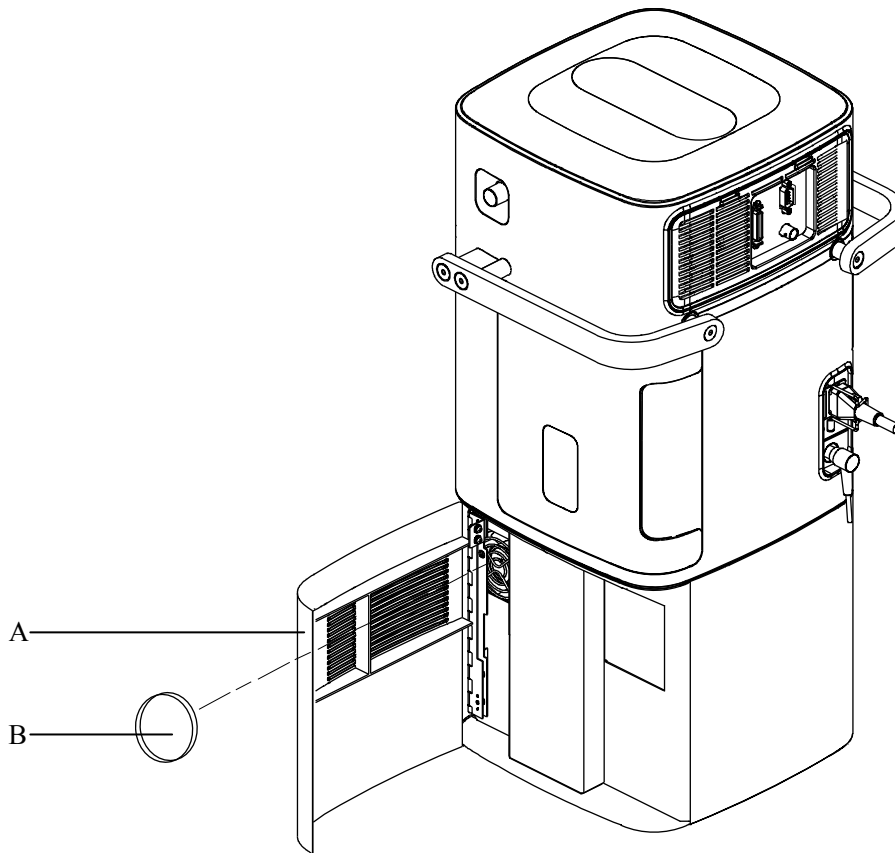

A. Back air supply maintenance door

B. Back air supply cooling fan dust filter

■ To disassemble:

1. Open backup air supply maintenance door.
2. Pinch the backup air supply cooling fan dust filter with two fingers and remove.

■ To install:

1. Place the fan dust filter of backup air supply in the corresponding position inside the cooling fan.
2. Close backup air supply access door.

12.2.5 Main Unit Air Outlet Dust Filter

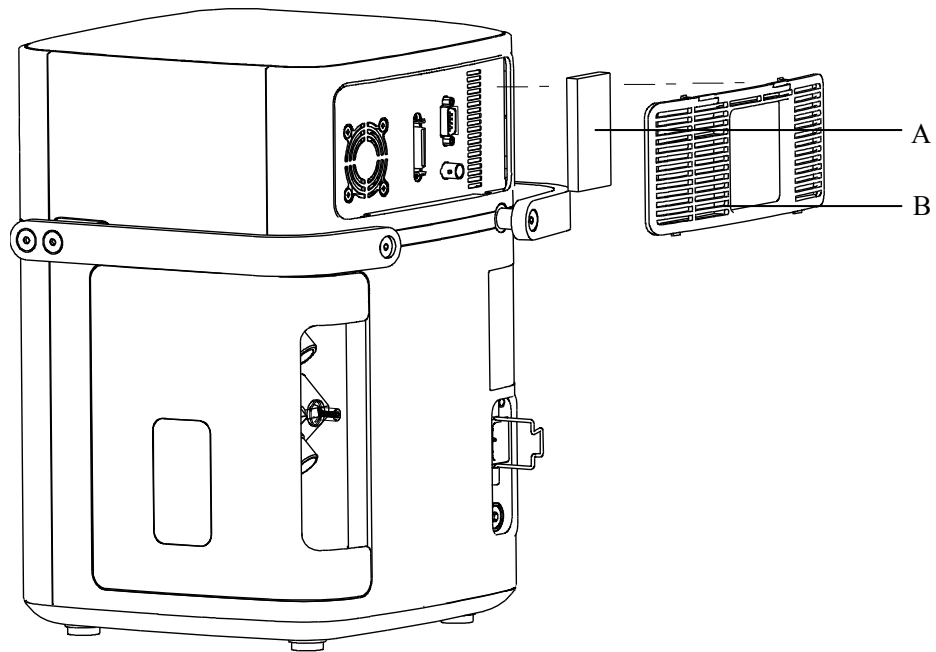

A. Main unit air outlet dust filter

B. Main unit air inlet/outlet grille

■ To disassemble:

1. Pull the two latches on the main unit air inlet/outlet grille to remove the grille.
2. Pull out the main unit air outlet dust filter upward.

■ To install:

1. Insert the main unit air outlet dust filter into the corresponding position of the main unit.
2. Insert the protruding supports at the bottom of the main unit air inlet/outlet grille into the corresponding grooves of the main unit to fasten the latch on the grille.

12.2.6 Patient Tubing

WARNING

- To minimize the risk of bacterial contamination or physical damage, remove and install the bacterial filter with care.
-

CAUTION

- When removing the reusable patient tubing, disconnect the tubes from the ventilator connectors instead of pulling the tubes.
-

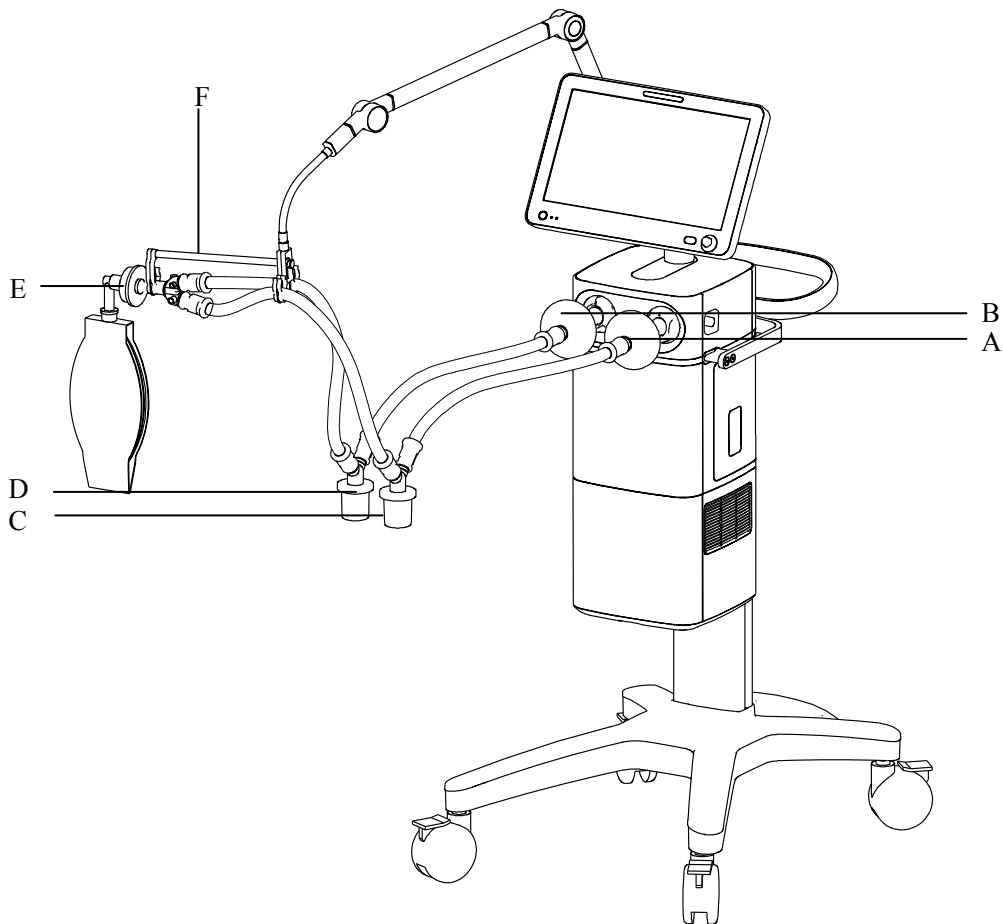

- | | |
|---------------------------|--------------------------|
| A. Inspiratory filter | B. Expiratory filter |
| C. Inspiratory water trap | D. Expiratory water trap |
| E. HME | F. Support arm hook |

- To disassemble:

Pull out the patient tubing one by one.

- To install:

1. Mount the filters onto the inspiratory and expiratory ports.
2. Connect the inspiratory filter to the water trap via the tubing. Then connect the water trap to the Y piece via the tubing.
3. Connect the expiratory filter to the water trap via the tubing. Then connect the water trap to the Y piece via the tubing.
4. Connect the patient side of the Y piece to the HME and then connect the patient to the HME.
5. Place the patient tubing onto the support arm hook.

12.2.7 Humidifier

NOTE

- The humidifier shall comply with the requirements of ISO 8185. The humidifier assembly, its installation and disassembling steps described in this section are only for reference.
-

12.2.7.1 Humidifier on the Ventilator

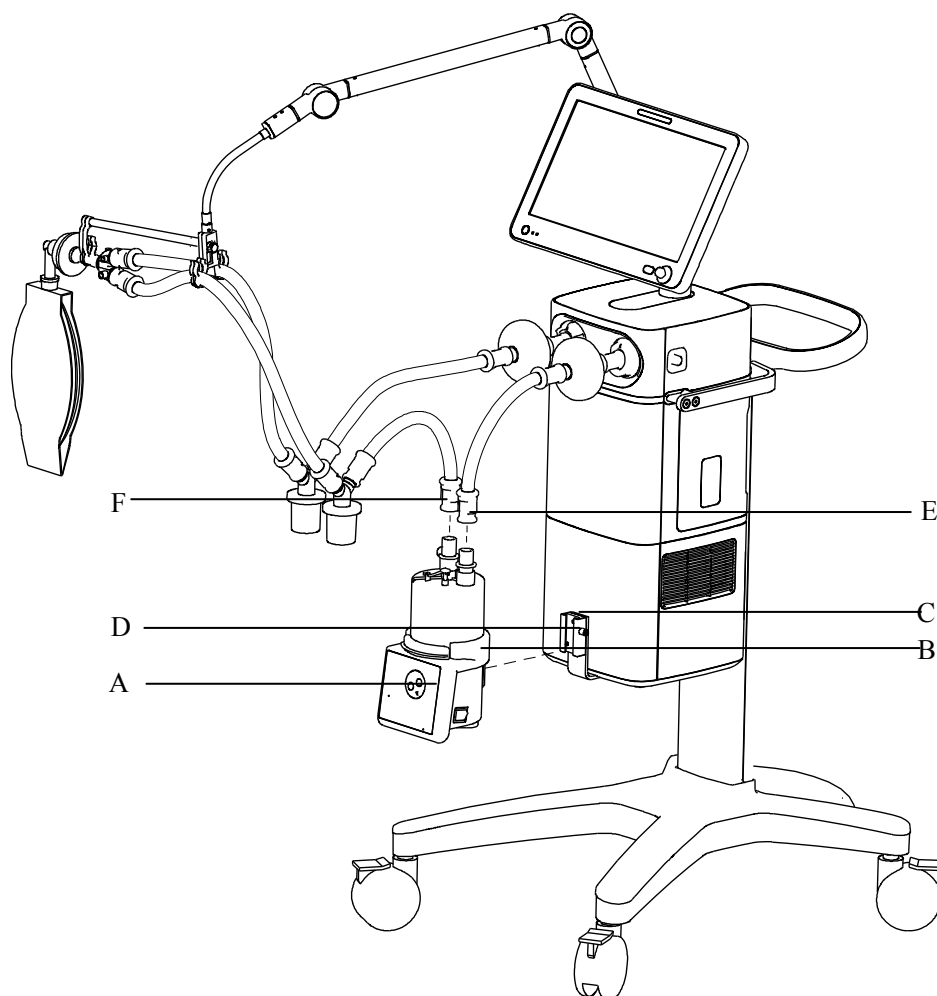

- | | | |
|---------------|------------------------------|----------------------------|
| A. Humidifier | B. Humidifier mounting plate | C. Humidifier bracket slot |
| D. Screw | E. Humidifier inlet | F. Humidifier outlet |

■ To disassemble:

1. Disconnect the tubes from the humidifier.
2. Remove the screw.
3. Lift up the humidifier to remove it from the humidifier bracket fixed seat.

-
- To install:
 1. Align the humidifier mounting plate and the slot, and slide the humidifier in.
 2. Tighten the screw.
 3. Mount the filters onto the inspiratory and expiratory ports.
 4. Connect the inspiratory filter to the humidifier inlet via the tube.
 5. Connect the humidifier outlet to the water trap via the tube. Then, connect the water trap to the Y piece via the tube.
 6. Connect the expiratory filter to the water trap via the tube. Then, connect the water trap to the Y piece via the tube.
 7. Place the patient tubing onto the support arm hook.

12.2.7.2 Humidifier on the Pendant

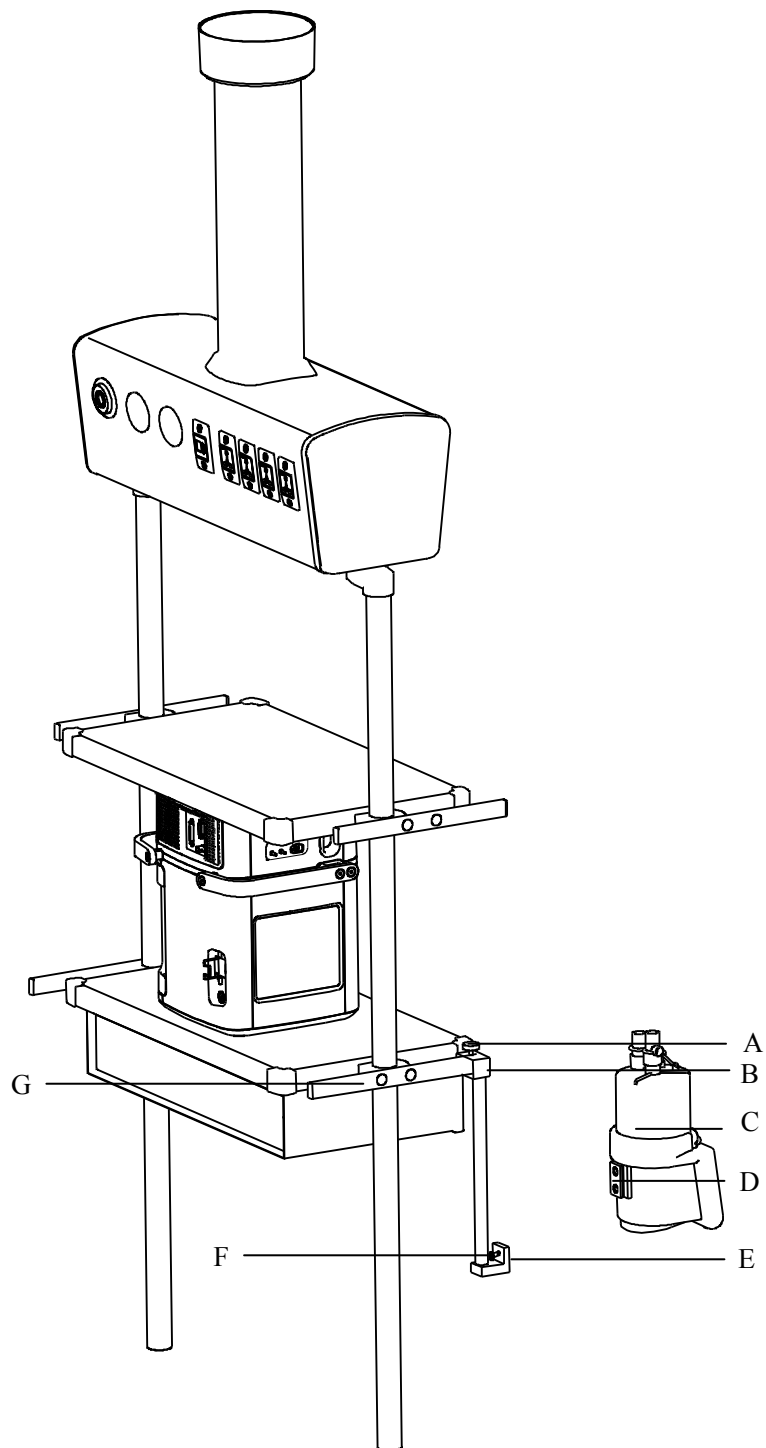

- | | | |
|------------------------------|----------------------------|-----------------|
| A. Humidifier | B. Fixing block knob | C. Fixing block |
| D. Humidifier mounting plate | E. Humidifier bracket slot | |
| F. Screw | G. Beam | |

■ To disassemble:

1. Disconnect the tubes from the humidifier.
2. Remove the screw.
3. Lift up the humidifier to remove it from the humidifier bracket fixed seat.

■ To install:

1. Loosen the fixing block knob. Place the fixing block onto the pendant beam.
2. Tighten the fixing block knob.
3. Align the humidifier mounting plate and the slot, and slide the humidifier in.
4. Tighten the screw.
5. Install the patient tubing. For detailed connection method, refer *12.2.7.1* steps 3 through 7.

 **WARNING**

-
- **Before installing the humidifier, ensure that the humidifier connector shall be lower than the ventilator's breathing connectors and the patient.**
-

12.2.8 Nebulizer

NOTE

-
- **Install the specified nebulizer. The nebulizer assembly, its installation and disassembling steps described in this section are only for reference.**
-

12.2.8.1 Pneumatic Nebulizer

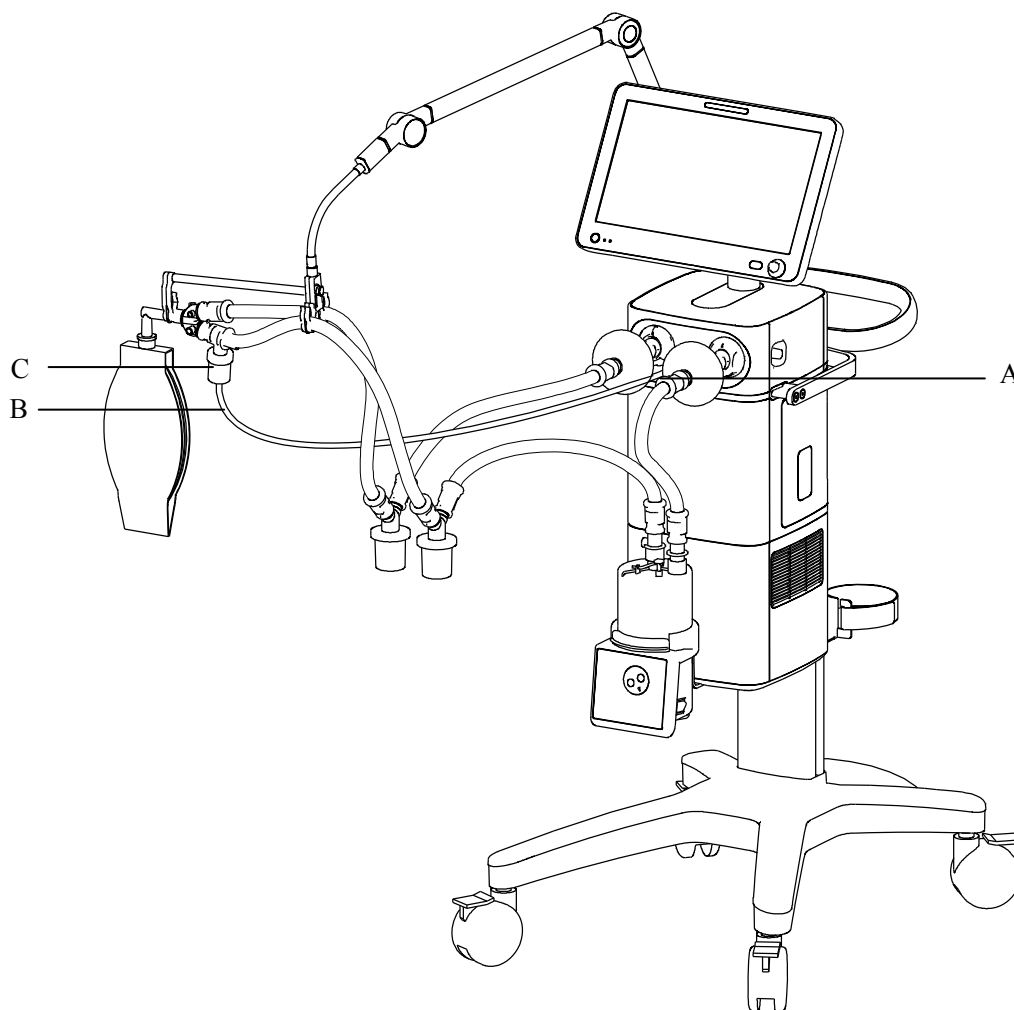

A. Nebulizer connector

B. Nebulizer tube

C. Nebulizer

■ To disassemble:

1. Pull out the nebulizer tube from the nebulizer connector.
2. Pull out the nebulizer tube from the nebulizer and remove the nebulizer.

■ To install:

1. Connect one end of the nebulizer tube to the nebulizer connector and the other end to the nebulizer.
2. Install the nebulizer in the inspiratory limb via the tube.

12.2.8.2 Electronic nebulizer

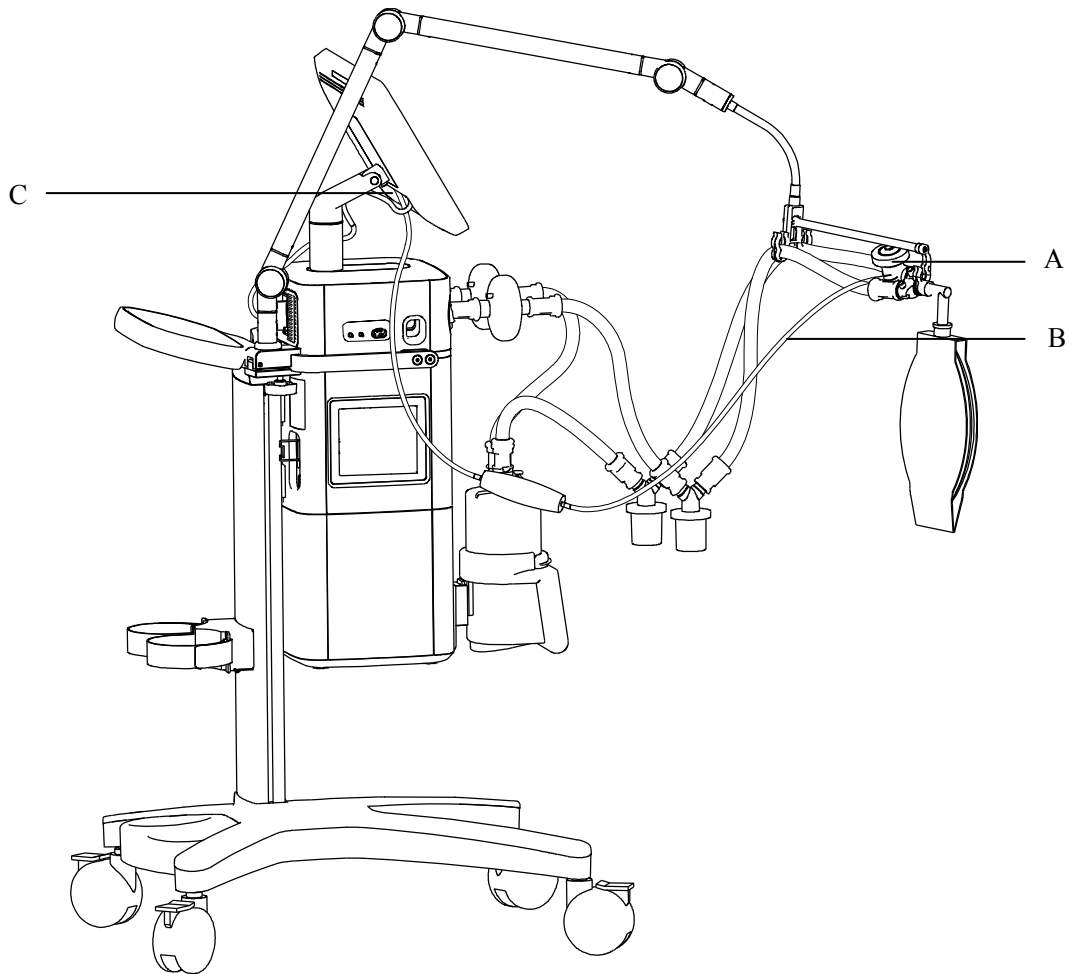

A. Nebulizer B. USB controller C. USB connector

■ To disassemble:

1. Pull out the USB connector of USB controller.
2. Pull out the nebulizer tube from the nebulizer and remove the nebulizer.

■ To install:

1. Insert the USB connector of USB controller into the USB port below the display
2. Connect the nebulizer with the patient tube. Refer to the nebulizer accompanying operator's manual for the details.

⚠ WARNING

- **Always maintain the nebulizer in a vertical orientation while in the patient circuit. This orientation helps prevent patient secretions and condensate from contaminating the aerosol generator of the nebulizer and ensures proper nebulization.**

⚠ WARNING

- Refer to the nebulizer accompanying operator's manual to install and use the nebulizer.
-
-

12.2.9 Mainstream CO₂ Module

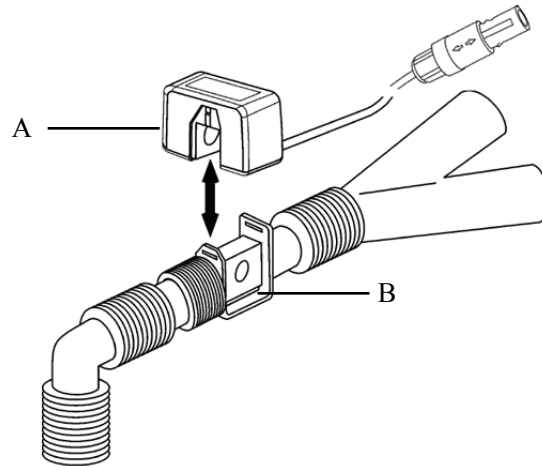

A. CO₂ sensor

B. CO₂ airway adapter

■ To disassemble:

Simply pull the CO₂ airway adapter out vertically upward.

■ To install:

Install the CO₂ sensor on the CO₂ adapter vertically downward.

13 Maintenance

13.1 Repair Policy

WARNING

- **Obey infection control and safety procedures. Used equipment may contain blood and body fluids.**
 - **Movable parts and removable components may present a pinch or a crush hazard. Take care to move or replace system parts and components.**
 - **Do not use lubricants that contain oil or grease, which will burn or explode when exposed to high O₂ concentrations.**
-
-

Do not use malfunctioning ventilator. Have all repairs and services done by an authorized service representative. Replacement and maintenance of the parts listed in this manual may be undertaken by a competent, trained individual having experience in the repair of devices of this nature.

After repair, test the ventilator to ensure that it is functioning properly, in accordance with the specifications.

NOTE



- **No repair should ever be attempted by anyone not having experience in the repair of devices of this nature.**
 - **Replace damaged parts with components manufactured or sold by us. Then test the unit to make sure that it complies with the manufacturer's published specifications.**
 - **Contact us for service assistance.**
 - **For further information about the product, contact us. We can provide documents about some parts depending on the actual condition.**
-



13.2 Maintenance Schedule



Interval	Part/accessory	Procedure
Each patient or as necessary	Patient tubing (including mask, inspiratory filter, flow sensor, expiration valve and membrane)	Perform pressure and flow zeroing (refer to 13.4); perform system self check (refer to 6.2); perform flow sensor calibration (refer to 13.6); replace with disinfected parts or new disposable parts.
As necessary	Inspiration safety valve assembly	When the patient's exhaled gas may contaminate the inspiratory safety valve assembly, this must be replaced with a disinfected inspiratory safety valve and membrane (refer to 12.2.2).
	Expiration valve	Replace the expiratory valve if it is damaged (refer to 12.2.1).
	CO ₂ Calibration	Calibrate the CO ₂ module when CO ₂ measured value has a great deviation (refer to 13.8).
	Touch screen	Calibrate the touch screen if its function is degraded (refer to 13.9).
Several times a day or as necessary	Patient Tubing	Check the patient tubing and water traps for water build-up. Empty water build-up if there is (refer to 12.2.6). Inspect the parts for damage. Replace as necessary (refer to 12.2.6).
During cleaning and setup	Ventilator	Inspect the parts for damage. Replace as necessary.
Daily or as necessary	Ventilator	Clean the external surfaces (refer to 12.1).
	O ₂ cell	Please calibrate the O ₂ cell (refer to 13.7). Replace CO ₂ cell if it is damaged.
	Water trap of air supply inlet	Check water trap of air supply inlet. If the water level is close to the filter element, please press the drainage key at the bottom of the water trap to drain the water. Please place a container under the water trap to catch the water, so that the water will not splash on the machine. After drainage key of drainage valve automatically re-place to its original position after drainage (if drainage in the ventilation status, please prevent water splash and use a container to prevent water from directly spraying to the battery bottom) and then place drainage tube to the slot. Please contact your service personnel if any crack and leakage is found on water trap.

Interval	Part/accessory	Procedure
Before each use or after continuous use of two weeks	Entire ventilator	Perform system self checking, and check the breathing system resistance and leakage (please refer to 6.2 and 6.3).
Monthly or as necessary	Air intake dust filter, fan dust filter and dust filter of main unit outlet	Check the dust filter for dust build-up. Clean or replace as necessary (refer to 12.2).
Check every 6 months and replace every three years	Lithium-ion battery	Check the charging and discharging of the lithium battery every 6 months and replace the lithium battery every three years. Contact us for replacement.
Annually or as necessary	Inspiration safety valve membrane	Check the inspiration safety valve membrane. Contact us for replacement if necessary.
Annually, or every 5000 hours, or as necessary	Ventilator	Contact us for preventive maintenance.
	O ₂ Cell	Replace the O ₂ cell if it is damaged (refer to 3.8 Install the Oxygen Sensor) . [Note] If ICU work normally, the service life of chemical O ₂ Sensor is one year. The service life of O ₂ sensor is an approximate specification only. The actual cell life depends on operating environment. Operation at higher temperatures or higher oxygen concentrations shortens cell life.
	Air intake HEPA filter	Replace (refer to 12.2.3).
	Expiration valve membrane	Check the expiration valve membrane. Contact us for replacement if necessary.
Every 6 years or as necessary	Battery of the clock module	Replace the battery of the clock module. Contact us for replacement.
If the preventive Maintenance key is shown on system Check interface or circuit test interface 	Backup air supply box (equipped with backup air supply module).	Contact us for replacement.

13.3 View Preventive Maintenance Items

If  or  is shown on system check or circuit test interface, it means:

- : indicates that there is no expired maintenance program and that preventive maintenance is not necessary.
- : indicates that there is an expired maintenance program and that preventive maintenance is necessary. Contact us for replacement.

Select  or  key, check the following information in the opened preventive Maintenance menu:

- Operation Hours: ventilator run time.
- Ventilation Hours: ventilator ventilation time.
- Backup Air Supply Running Hours

13.4 Pressure and Flow Zeroing

Zero pressure and flow when the monitored pressure or flow value has a great deviation. Zeroing can be performed in both standby status and the process of ventilation.

1. Press the [**Menu**] key → [**Calibration**] → [**Zero Calibration**], and then select [**Start**] key corresponding to the pressure and the flow zero on the right side. Pressure and flow zeroing are initiated and the [**Zero Calibration Running**] message is prompted.
2. After successful zeroing, the [**Zeroing Completed!**] prompt message is displayed. Otherwise, a message indicating zeroing failure will be displayed. In this case, you need to perform zeroing again.

13.5 Neonatal Flow Sensor Zeroing

Please perform neonatal flow sensor zeroing when there is a great deviation in the measured flow values. Zeroing can be performed in both standby status and the process of ventilation.

1. Press the [**Menu**] key → [**Calibration**] → [**Zero Calibration**], and then select [**Start**] key corresponding to the zero calibration of the neonatal flow sensor on the right side. The [**Zero Calibration Running**] prompt message is displayed.
2. After successful zeroing, the [**Zeroing Completed!**] prompt message is displayed. Otherwise, a message indicating zeroing failure will be displayed. In this case, you need to perform zeroing again.

NOTE

-
- **The neonatal flow sensor performs zeroing once an hour in the ventilation mode. The Expiration Hold function is activated during zeroing, and normal ventilation is reinstated after zeroing.**
-

13.6 Flow Calibration

NOTE

- **Do not perform calibration while the unit is connected to a patient.**
 - **During calibration, do not operate the pneumatic parts. Especially, do not move or press the patient tubing.**
 - **Ensure that the system is in Standby status. If not, push the [Standby] key to enter standby screen.**
 - **It is recommended not to connect the humidifier to the ventilator before the calibration.**
-

Calibrate the flow sensor when the measured value has a great deviation from the setting, or when the flow sensor is replaced.

Follow these steps to calibrate flow:

1. Ensure O₂ supply and air supply connected.
2. Connect the patient tubing and insert the Y piece into the leak test plug to close the breathing circuit.
3. Select the [Menu] key→[Calibration]→[Flow Calibration], and then select [Start] on the right-hand side. Flow calibration is initiated and the [Calibrating] prompt message is displayed.
4. During the calibration, if you select [Stop], the ongoing calibration will be terminated and the message [Calibration Stopped! Calibration is unfinished.] is displayed.
5. After a successful calibration, the [Calibration Completed!] prompt message is displayed. Otherwise, a message indicating calibration failure will be displayed. In this case, you need to perform the calibration again.

NOTE

- **In case of calibration failure, check for relevant malfunctioning alarm and then troubleshoot it. If it still fails or great measurement deviation occurs after troubleshooting, replace the flow sensor and repeat the above operations. If the measurement deviation is still significant, contact the authorized service personnel.**
-

13.7 O₂% Calibration

NOTE

- **Do not perform oxygen concentration calibration while the unit is connected to a patient.**
 - **Ensure that the system is in Standby status. If not, push the [Standby] key to enter standby screen.**
-

If the ventilator uses the O₂ cell, calibrate the oxygen concentration when the measured oxygen concentration displays great deviation from the settings, or when the O₂ sensor is replaced.

Follow these steps to calibrate the oxygen concentration:

1. Ensure O₂ supply and air supply connected.
2. Press the [Menu] key→Select [Calibration]→[O₂ Calibration], and then Select [Start] on the right-hand side. O₂% calibration is initiated and the [Calibrating] prompt message is displayed.
3. During the calibration, if you select [Stop], the ongoing calibration will be terminated and the message [Calibration Stopped! Calibration is unfinished.] is displayed.
4. After a successful calibration, the [Calibration Completed!] prompt message is displayed. Otherwise, a message indicating calibration failure will be displayed. In this case, you need to perform the calibration again.

NOTE

- **In case of calibration failure, check for relevant malfunctioning alarm and then troubleshoot it. Then do the calibration again. In case of repeated calibration failures, replace the chemical O₂ sensor and perform the calibration again. If it still fails, contact your service personnel or us.**
 - **Handle and dispose of the chemical O₂ sensor in accordance with your biohazard policies. Do not incinerate.**
 - **Oxygen concentration monitoring does not provide automatic atmospheric pressure compensation. Do oxygen concentration calibration again when atmospheric pressure has changed.**
 - **Increasing to periodical pressure of 10 kPa (100 cmH₂O) has no effect upon oxygen concentration monitoring accuracy.**
 - **Chemical O₂ cell measures the partial pressure of oxygen. Increases or decreases in pressure (absolute pressure) affect the partial pressure of oxygen. Increase of pressure (absolute pressure) by 10 % causes oxygen concentration to increase by 10 %. Decrease of pressure (absolute pressure) by 10 % causes oxygen concentration to decrease by 10 %. Do oxygen concentration calibration when**
-

NOTE

atmospheric pressure has changed.

13.8 CO₂ Calibration

13.8.1 Sidestream CO₂ Module

NOTE

- Ensure that the system is in Standby status. If not, push the [Standby] key to enter standby screen.
-

Prepare the following before doing the calibration:

- Gas cylinder: cylinders filled with 3 % to 7 % CO₂
- T-shape connector
- Sampling line

Follow these steps to perform CO₂ calibration:

1. Check the airway and ensure that there is no occlusions or leaks. Ensure that the CO₂ module is already warmed-up or started.
2. Select the [Menu] → [Calibration] → [CO₂ In Maintenance] and then select [Zero Calibration] key.
3. After zeroing, connect the gas cylinder to the sampling line via a T-shape connector as shown below. Check the airway and ensure that there are no leaks.

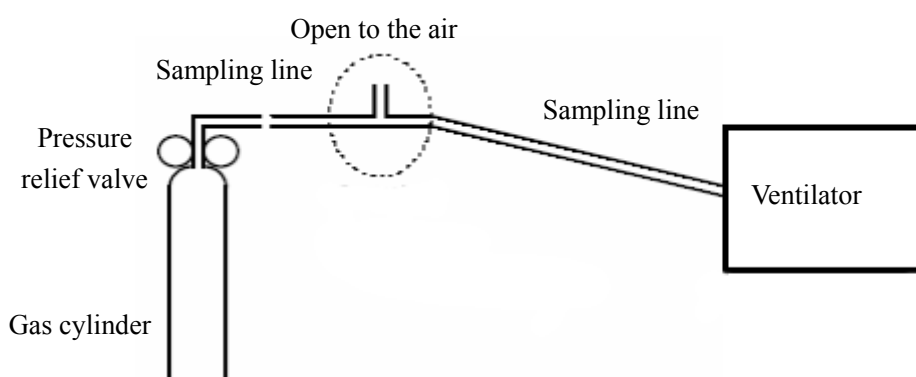

4. Expose the sampling line to standard CO₂ by opening the cylinder pressure relief valve.
5. Enter the standard CO₂ concentration in the corresponding box in screen window.
6. The measured CO₂ concentration is displayed in the screen window. After the measured CO₂ concentration becomes stable, select [Calibration] to calibrate the CO₂ module. The message [Calibrating] will be displayed.



-
7. After a successful calibration, the [**Calibration Completed!**] prompt message is displayed. Otherwise, the message [**Calibration Failure! Please try again.**] is displayed. In this case, you need to do the calibration again.

13.8.2 Mainstream CO₂ Module

For a mainstream CO₂ module, manual calibration is not required. The system sends altitude to the mainstream CO₂ module for calibration compensation.

13.9 Touch Screen Calibration

NOTE

-
- **Ensure that the system is in Standby status. If not, push the [Standby] key to enter standby screen.**
-
1. Select the [Menu] key→[Screen]→ [Screen Calibration], and then select the [Start] key on the right-hand side.
 2. The  icon appears in different locations of the screen.
 3. Click the central point of  one by one.
 4. After the calibration, the message [Screen Calibration Succeed!] is displayed. Select [Ok] to complete calibration. If the control knob is pressed or rotated during calibration, the message [Screen Calibration Stopped] is displayed. Select [Ok] to exit the calibration.

13.10 Battery Maintenance

WARNING

- **The service life of lithium battery is 3 years. After the service life of lithium-ion battery expires, please replace a new one.**
-

CAUTION





- **The batteries can only be charged by this ventilator.**
-

NOTE

- **Use batteries at least once every month to extend their lives. Charge the batteries before they are depleted.**
 - **Inspect and replace batteries regularly. Battery life depends on how frequent and how long battery is used. For a properly maintained and stored lithium battery, its life expectancy is approximately 3 years. For more aggressive use models, life expectancy can be shortened.**
 - **In case of battery failure, contact us or have your service personnel replace it. Do not replace the battery without permission.**
-

The ventilator is designed to operate on battery power whenever power supply becomes interrupted. When the ventilator is connected to the external power source, the batteries are charged regardless of whether the ventilator is currently on or not. In case of power failure, the ventilator will automatically be powered by the internal batteries. When external power source is restored within the specified time, power supply is switched from battery to external power supply automatically to ensure continuous system use.

On-screen battery icon indicates the battery statuses as follows:

-  : indicates that external power source is connected. The ventilator is powered by external power source. The solid blue portion represents the current charge level of the batteries in proportion to its maximum charge level.
-  : indicates that external power source is not connected. The ventilator is powered by built-in batteries. The solid blue portion represents the current charge level of the batteries in proportion to its maximum charge level.
-  : indicates that external power source is not connected. The ventilator is powered by built-in batteries. The battery capacity is low and the batteries need to be charged immediately.
-  : indicates that no batteries are installed.

If the internal battery capacity is limited, the alarm [**System DOWN. Connect Ext. Power.**] will be triggered and a warning menu will pop-up. In this case, connect an external power source to the ventilator.

13.10.1 Battery Guidelines

Inspect and replace batteries regularly. Battery life depends on how frequent and how long battery is used. For a properly maintained and stored lithium battery, its life expectancy is approximately 3 years. For more aggressive use models, life expectancy can be shortened. We recommend replacing lithium batteries every 3 years.

To ensure maximum battery capacity, please adhere to the following use instructions:

- Check battery performance once every six months. Checking battery performance is also required before ventilator repair is carried out or when battery is doubted to be the source for ventilator failure.
- Condition batteries whenever they have been used for three months, or when the battery running time becomes noticeably short.

13.10.2 Battery Performance Conditioning

Condition batteries when they are put into use for the first time. A complete battery conditioning cycle is: uninterrupted charging, followed by uninterrupted discharging until the ventilator shuts off, and then uninterrupted charging. Condition batteries regularly to maintain their service lives.

NOTE

- **Condition batteries every time when they have been used for three months or when the battery running time becomes noticeably short.**
 - **Over time and with the use of the battery, the actual battery capacity will decrease. For an old battery, the battery full icon does not indicate that the battery capacity or battery running time still meets the requirement specified. When conditioning batteries, replace the battery when its running time becomes noticeably short.**
-

Follow these steps to condition batteries:

1. Disconnect the patient from the ventilator and shut down the ventilator.
2. Connect the ventilator to the external power source and charge the batteries uninterruptedly for at least 10 hours.
3. Disconnect the external power source. Allow the ventilator to operate on battery power until the ventilator shuts off.
4. Re-connect the ventilator to the external power source and charge the batteries uninterruptedly for at least 10 hours.
5. Battery conditioning is now completed.

13.10.3 Battery Performance Checking

Check battery performance once every six months. Checking battery performance is also required before ventilator repair is carried out or when battery is doubted to be the source for ventilator failure. Battery performance may degrade over time.

Follow these steps to check battery performance:

1. Disconnect the patient from the ventilator and shut down the ventilator.
2. Connect the ventilator to the external power source and charge the batteries uninterruptedly for at least 10 hours.
3. Disconnect the external power source. Allow the ventilator to operate on battery power until the ventilator shuts off.
4. The running time of the battery reflects its performance.

If the running time of the battery is noticeably shorter than that stated in the specifications, replace the battery or contact the service personnel.

NOTE

-
- **If the running time of the battery is too short after fully charged, the battery may be damaged already or defective.**
 - **If obvious signs of damage are detected on the battery or the battery recharging has failed, replace the battery and recycle it properly.**
-

13.10.4 Battery Storage

During storing batteries, ensure the battery electrodes do not get in touch with metal. In case of long-time storage, place batteries in a cool environment and keep battery power at 40% to 60%.

Placing batteries in a cool environment can delay battery aging. Ideally, batteries should be stored in a cool environment of 15°C (60°F). Do not store batteries outside the environmental range of -20°C (-4°F) to +60°C (140°F).

Remove the batteries from the ventilator if the ventilator is not used for a long time. Failure to do so will over-discharge the batteries and extend the battery charging time noticeably. Fully charge the batteries once every 2 months and keep battery power at 40% to 60%. Fully charge the batteries before use.

NOTE

- **Remove the batteries from the equipment if the equipment is not used for a long time.**
 - **Long-time storage of batteries above 38°C (100°F) greatly shortens the battery life expectancy.**
-

13.10.5 Battery Recycling

If obvious signs of damage are detected on the battery or the battery recharging has failed, replace the battery and recycle it properly. Dispose of the battery in compliance with the local laws regulating the disposal of such product.

WARNING

- **Do not disassemble batteries, or dispose of them in fire, or short-circuit them. They may ignite, explode and leak, causing personal injury.**
-

13.11 Electrical Safety Inspection

NOTE

- **Perform an electrical safety inspection after servicing or routine maintenance. Before performing the electrical safety inspection, ensure that all the covers, panels, and screws are correctly installed.**
 - **It is recommended that a specialized company or the manufacturer be entrusted to conduct electrical safety tests. The electrical safety inspection should be performed once a year.**
-

1. Perform protective earth resistance test:
 - a. Plug the probes of the analyzer into the protective earth terminal of the AC power cord and the screw.
 - b. Test the earth resistance with a current of 25A.
 - c. Verify the resistance is less than 0.1ohms (100 mohms).
 - d. If the resistance is larger than 0.1ohms (100 mohms) but less than 0.2ohms (200 mohms), disconnect the AC power cord and plug the probe, that was previously plugged in the protective earth terminal of the AC power cord, into the protective earth contact of the power outlet. Repeat steps a to c.
-

2. Perform the following earth leakage current tests:

- normal polarity
- reverse polarity
- normal polarity with open neutral
- reverse polarity with open neutral.

Verify that the maximum leakage current does not exceed 500 μA (0.5 mA) in the first two tests. In the final two tests, verify that the maximum leakage current does not exceed 1000 μA (1 mA).

3. Perform the following patient leakage current tests:

- normal polarity
- reverse polarity
- normal polarity with open neutral
- reverse polarity with open neutral.
- normal polarity with open earth.
- reverse polarity with open earth.
- Mains on applied part (mains on AP), normal polarity
- Mains on applied part (mains on AP), reverse polarity

4. Verify that the maximum leakage current in the first two tests is not higher than 10 μA (0.01 mA) on the CF type applied parts and not higher than 100 μA (0.1 mA) on the BF type applied parts; that the maximum leakage current in the middle four tests is not higher than 50 μA (0.05 mA) on the CF type applied parts and not higher than 500 μA (0.5 mA) on the BF type applied parts; that the maximum leakage current in the last two tests is not higher than 50 μA (0.05 mA) on the CF type applied parts and not higher than 5000 μA (5 mA) on the BF type applied parts.

NOTE

-
- **Ensure the safety analyzer is authorized by certificate organizations (UL, CSA, or AAMI etc.). Follow the instructions of the analyzer manufacturer.**
-

13.12 Water Build-up in the Flow Sensor

13.12.1 Prevent Water Build-up

The patient's exhaled warm and moist gas is condensed when it flows through the expiratory hose. The condensed water remains on the hose wall and finally enters the water trap. When the patient's exhaled gas arrives at the expiration valve, condensed water may appear at the expiration valve (including the expiratory flow sensor), compromising the measurement accuracy of expiratory flow sensor.

Check the expiration valve for water build-up when abnormal flow waveform or unstable tidal volume fluctuation is detected. If there is water build-up inside the expiration valve, clear it before use.

Check the expiratory water trap for water during the use of the ventilator. If there is water build-up, empty it promptly. Water condensation in the expiration valve can be reduced by using a bacteria filter between the expiratory tube and expiration valve.

13.12.2 Clear Water Build-up

If there is water built up inside the expiration valve, remove the expiration valve and clear the water. Then reinstall the valve for use.

WARNING

- **Ensure that all breathing system parts are dry every time when the breathing system is cleaned and disinfected.**
 - **Check the expiration valve for water build-up when abnormal flow waveform or unstable tidal volume fluctuation is detected. If there is water build-up inside the expiration valve, clear it.**
-

FOR YOUR NOTES

14 Accessories

WARNING

- Use only accessories specified in this chapter. Using other accessories may cause incorrect measured values or equipment malfunction.
 - Disposable accessories can not be reused. Reuse may degrade performance or cause cross infection of the next patient.
 - Check the accessories and their packages for damage. Do not use them if any sign of damage is detected.
 - Parts which are intended to contact patients must comply with the biocompatibility requirement of ISO10993-1 to prevent any adverse reactions arising from such contact.
 - Disposal of the accessories shall comply with the applicable waste control regulations.
 - The user shall buy legally launched products for other accessories required to implement the functions of the machine.
-

NOTE

- All the accessories listed are validated for use with this specific ventilator. And the hospital is responsible for ensuring the compatibility of the ventilator and the accessories before use. The incompatible parts can result in degraded performance.
 - The CO₂ and SpO₂ module accessory material that contacts the patients has undertaken the bio-compatibility test and is verified to be in compliance with ISO 10993-1.
-

Accessories	Description	PN	Manufacturer
Patient tubing kit (including breathing tubes, connectors, water trap, etc.)	Reusable adult breathing tube package	040-001892-00	Mindray
	Reusable pediatric/infant breathing tube package	040-001894-00	Mindray
	Disposable adult breathing tube package	040-001884-00	Mindray
	Disposable pediatric breathing tube package	040-001886-00	Mindray

	Breathing tubes (Evatherm/heating)	040-002338-00	Fisher&Paykel
Filter	Filter used for the breathing system (small size)	040-001570-00	VADI
	Filter used for the breathing system (large size)	040-001571-00	VADI
	Disposable anesthesia breathing filter	040-001831-00	Mindray
Nebulizer	Hand held micro spray bottle group	040-000799-00	VADI
	Electrical nebulizer (SOLO)	040-003539-00	Aerogen
	Aeroneb Solo nebulizer	040-003549-00	Aerogen
	Aeroneb Solo T-adapter	040-003548-00	Aerogen
Mask	NIV mask, small size, with head band	040-001860-00	Mindray
	NIV mask, medium size, with head band	040-001861-00	Mindray
	NIV mask, large size, with head band	040-001862-00	Mindray
	NIV mask, small size	040-002373-00	Fisher&Paykel
	NIV mask, medium size	040-002374-00	Fisher&Paykel
	NIV mask, large size	040-002375-00	Fisher&Paykel
O ₂ therapy	O ₂ therapy mask (large size, adult)	040-002365-00	Galemed
	O ₂ therapy mask (small size, child)	040-002366-00	Galemed
	O ₂ therapy nasal cannula for neonate	040-002904-00	Fisher&Paykel
	O ₂ therapy nasal cannula for pediatric	040-002905-00	Fisher&Paykel
	Nasal catheter (small)(10)	115-037829-00	Fisher&Paykel
	Nasal catheter (medium)(10)	115-037830-00	Fisher&Paykel
	Nasal catheter (large)(10)	115-037831-00	Fisher&Paykel
	Nasal Cannula, small size	040-002376-00	Fisher&Paykel
	Nasal Cannula, medium size	040-002377-00	Fisher&Paykel
Nasal Cannula, large size	040-002378-00	Fisher&Paykel	
Test lung	Test Lung (adult)	040-000744-00	VADI
	Test Lung (infant)	040-000745-00	VADI
Humidifier kit (including humidifier, water tank, heated patient tubing, etc.)	Humidifier (SH330/European standard)	115-018049-00	Ji Ke
	Humidifier (SH330/American standard/110V)	115-018051-00	Ji Ke
	Humidifier (SH330/British standard)	115-018053-00	Ji Ke
	Humidifier (SH330/American standard/220V)	115-018054-00	Ji Ke
	Humidifier (SH530/heating/disposable tube/European standard)	115-018056-00	Ji Ke
	Humidifier (SH530/heating/disposable tube/American standard/110V)	115-018058-00	Ji Ke
	Humidifier (SH530/heating/disposable tube/British standard)	115-018060-00	Ji Ke
	Humidifier (SH530/heating/disposable	115-018061-00	Ji Ke

tube/American standard/220V)		
Humidifier SH530/heating/disposable tube/European standard (infant)	115-028494-00	Ji Ke
Humidifier SH530/heating/disposable tube/British standard (infant)	115-028498-00	Ji Ke
Humidifier SH530/heating/disposable tube/American standard 110V (infant)	115-028500-00	Ji Ke
Humidifier SH530/heating/disposable tube/American standard 220V (infant)	115-028502-00	Ji Ke
Humidifier (SH330/230V/Brazil)	115-032096-00	Ji Ke
Humidifier (SH330/110V/Brazil)	115-032097-00	Ji Ke
Humidifier (SH530/230V/Brazil/heating/disposable tube)	115-032098-00	Ji Ke
Humidifier (SH530/110V/Brazil/heating/disposable tube)	115-032099-00	Ji Ke
Humidifier (SH530/230V/Brazil/heating/disposable tube/infant)	115-032100-00	Ji Ke
Humidifier (SH530/110V/Brazil/heating/disposable tube/infant)	115-032101-00	Ji Ke
Humidifier (810/230V/Brazil/adult)	115-032090-00	Fisher&Paykel
Humidifier (810/115V/Brazil/adult)	115-032091-00	Fisher&Paykel
Humidifier (850/230V/Brazil/adult/heating/tube)	115-032092-00	Fisher&Paykel
Humidifier (850/115V/Brazil/adult/heating/tube)	115-032093-00	Fisher&Paykel
Humidifier (850/230V/Brazil/infant/heating/tube)	115-032094-00	Fisher&Paykel
Humidifier (850/115V/Brazil/infant/heating/tube)	115-032095-00	Fisher&Paykel
Humidifier (MR850/230V/adult/heating/tube)	115-004511-00	Fisher&Paykel
Humidifier (MR 850/ Australian standard/infant/heating/tube)	115-004512-00	Fisher&Paykel
Humidifier (MR810/230V/adult /tube)	115-004515-00	Fisher&Paykel
Humidifier (850/European standard/adult/heating/tube)	115-008354-00	Fisher&Paykel
Humidifier (850/European standard/infant/heating/tube)	115-008355-00	Fisher&Paykel
Humidifier (810/British standard/adult)	115-008358-00	Fisher&Paykel

	Humidifier (810/European standard/adult)	115-008359-00	Fisher&Paykel
	Humidifier (810/230V general/adult)	115-008360-00	Fisher&Paykel
	Humidifier (850/Aus/adult/heating/disposable tube)	115-046049-00	Fisher&Paykel
	Humidifier (850/Aus/infant/heating/disposable tube)	115-046050-00	Fisher&Paykel
	Humidifier (850/115V/adult/heating/disposable tube)	115-046051-00	Fisher&Paykel
	Humidifier (850/115V/infant/heating/disposable tube)	115-046052-00	Fisher&Paykel
	Humidifier (850/230V/general/adult/heating/disposable tube)	115-046057-00	Fisher&Paykel
	Humidifier (850/230V/general/infant/heating/disposable tube)	115-046058-00	Fisher&Paykel
	Humidifier (850/ EU /adult/heating/disposable tube)	115-046055-00	Fisher&Paykel
	Humidifier (850/ EU /infant/heating/disposable tube)	115-046056-00	Fisher&Paykel
	Humidifier (850/UK/adult/heating/disposable tube)	115-046053-00	Fisher&Paykel
	Humidifier (850/UK/infant/heating/disposable tube)	115-046054-00	Fisher&Paykel
Humidifier water tank	Disposable automatic humidifying water tank	040-002173-00	Ji Ke
	Humidifier water tank (with one connector) EU version	040-001530-00	Ji Ke
	Infant humidifying water tank	040-000709-00	Fisher&Paykel
	Adult humidifying water tank	040-000710-00	Fisher&Paykel
Humidifier tubing kit	Infant heating strip patient tubing	040-002172-00	Ji Ke
	Infant single heating patient tubing package	040-000711-00	Fisher&Paykel
	Adult single heating patient tubing package	040-000715-00	Fisher&Paykel
Gas supply hose assembly	Gas supply hose accessories kit (German standard, 3m)	115-008366-00	GENTEC
	Gas supply hose accessories kit (French standard, 3m)	115-008367-00	GENTEC
	Gas supply hose accessories kit	115-008368-00	GENTEC

	(Australian standard, 3m)		
	Gas supply hose accessories kit (British standard, 3m)	115-008365-00	GENTEC
	Gas supply hose accessories kit (British standard)	0621-30-69557	GENTEC
	Gas supply hose accessories kit (American standard/DISS)	115-002874-00	GENTEC
	Gas supply hose accessories kit (American standard/dual connector/DISS)	115-003113-00	GENTEC
	Gas supply hose accessories kit (American standard/dual connector/DISS/3m)	115-008372-00	GENTEC
	Gas supply hose accessories kit (American standard/single connector/DISS/3m)	115-008370-00	GENTEC
Oxygen sensor	Oxygen sensor	040-001275-00	City
	Paramagnetic oxygen sensor	012-000091-00	SERVOMEX
CO ₂ module accessories	Mainstream CO ₂ module accessories kit	6800-30-50613	Respironics
	Sidestream CO ₂ module accessories kit (adult/pediatric)	115-025015-00	/
	Sidestream CO ₂ module accessories kit (neonatal)	115-025016-00	/
	CO ₂ module (CAPNOSTAT)	6800-30-50487	Mindray
	CO ₂ module (one slot)	115-027545-00	Mindray
SpO ₂ module accessories*	SpO ₂ module accessories kit (adult)	0651-30-77014	/
	SpO ₂ module accessories kit (pediatric)	0651-30-77015	/
	SpO ₂ module accessories kit (neonate)	0651-30-77016	Mindray
	SpO ₂ module assembly	115-015012-00	Mindray
Bracket	Pendant mounting bracket of the humidifier	115-006158-00	Mindray
Expiration valve	Sterilizable expiration valve assembly	115-021461-00	Mindray
Safety valve	Detachable part of the safety valve	115-021478-00	Mindray
Lithium battery	Lithium battery material kit (delivered separately)	115-034132-00	/
Power cord	WIRE, power cord, British standard	DA8K-10-14453	BIZILINK
	WIRE, 3-core power cord, 2.5M 250V 10A NEMA5-15P receptacle	009-000567-00	BIZILINK
	AC power cord (European standard, 3.5M)M2511-V1625	TSB1-20-20509	VOLEX
	AC power cord (American standard, 3.5M)PS206-V1625	TSB1-20-20510	VOLEX

	Power cord, Brazil standard, 250V, 10A, 3M	009-001075-00	VOLEX
	3-core power cord (3.5m)	009-005400-00	VOLEX
	Power cord (South Africa, 3m)	009-007786-00	VOLEX
	Power cord (Indian, 3m)	009-007190-00	VOLEX
Support arm	Support arm	045-000625-00	Mindray
Connecting line	Ventilator display connecting line	009-006741-00	Mindray
Trolley	Trolley (international/including packing materials)	045-003318-00	Mindray
Neonate accessories	Disposable neonate breathing circuit package	040-002751-00	APLUS
	Flow sensor, neonate, 1.8m	040-001948-00	Galeded
	nCPAP accessories kit (neonate)	115-041555-00	Fisher&Paykel
HEPA filter	HEPA filter	045-001333-01	ZJNF
Dust filter	Air intake dust filter	045-001298-01	Guozhihuifu
Gas valve	Gas valve, high-pressure cylinder pressure reducer, 14Mpa	082-001927-00	GENTEC
others	Inlet mixer foam	048-007169-00	/
	Filter cotton	048-006955-00	/
	Alternative foam for arm	048-005659-00	/

* :

The pulse oximeter probes and probe cable extenders listed for this device have been validated and tested for compliance with ISO 80601-2-61.

The SpO₂ sensor material that contacts patients or other staff has undertaken the bio-compatibility test and is verified to be in compliance with ISO 10993-1.

Wavelength emitted by the sensors intended for Mindray SpO₂ module: red light: 660 nm, infrared light: 905 nm.

The maximum photic output consumption of the sensor is less than 18 mW.

The information about the wavelength range and maximum photic output consumption can be especially useful to clinicians, for example, clinicians performing photodynamic therapy.

A Theory of Operation

A.1 Pneumatic Circuit Principle

A.1.1 Pneumatic Circuit Diagram

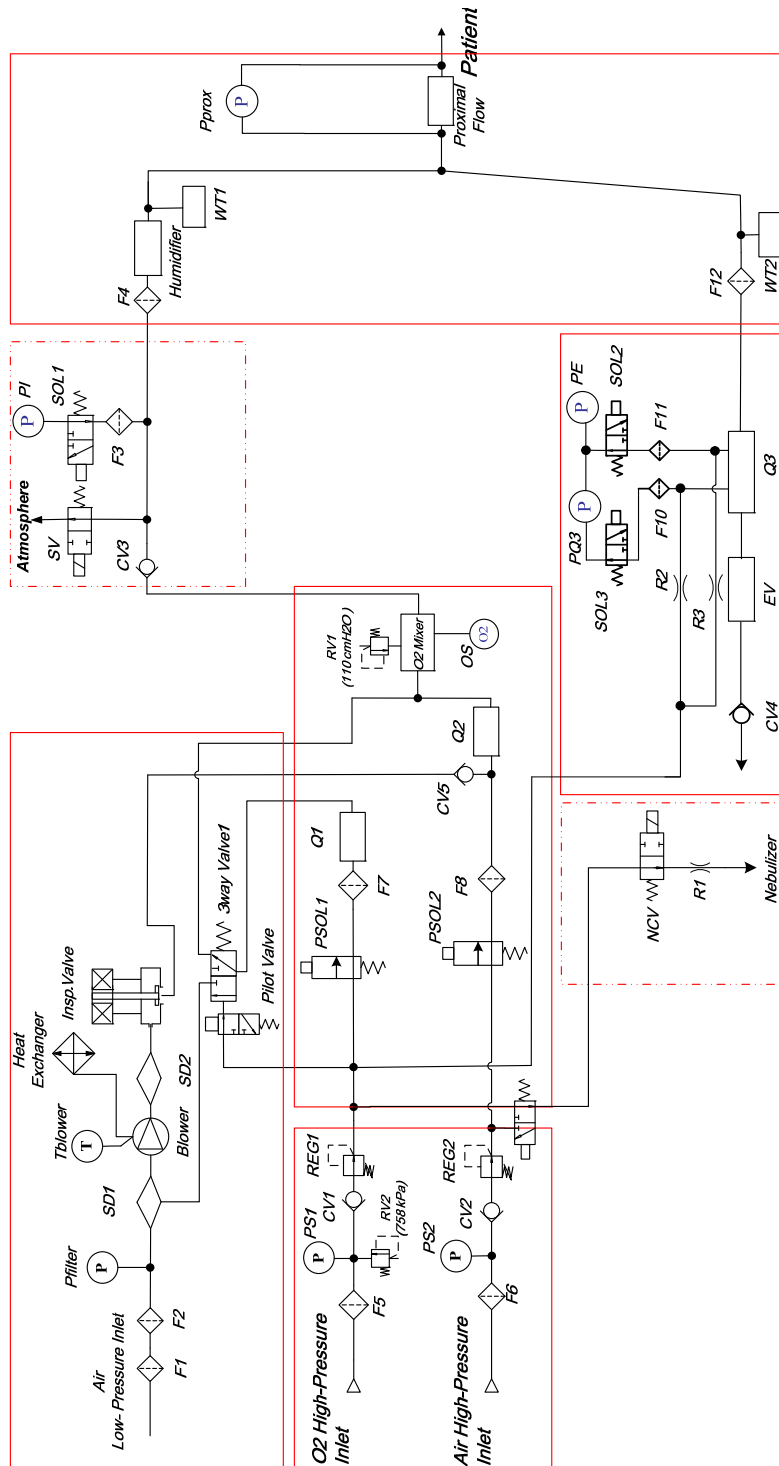















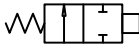

A.1.2 Parts List

Symbol	Name	Symbol	Name
Air Low-Pressure Inlet	Air Low-Pressure Inlet	Blower	Backup Air Supply Fan
O ₂ High-Pressure Inlet	High-pressure oxygen inlet	Tblower	Temperature sensor
Air High-Pressure Inlet	Air High-Pressure Inlet	SD2	Noise reduction and air/oxygen mix chamber
F5	Oxygen inlet filter	Heat Exchanger	Heat exchanger
F6	Air inlet filter	Insp. valve	Low pressure large-diameter suction valve
PS1,PS2	Pressure sensor	Pilot Valve	Pilot valve
CV1, CV2	Gas supply inlet check valve	CV3	Inspiratory check valve
REG1, REG2	Regulator	SV	Safety valve
PSOL1, PSOL2	Proportional solenoid valve	F3	Bacteria filter
F7,F8	Filter screen	SOL1	Inspiratory pressure zeroing three-way valve
Q1, Q2	Flow sensor	PI	Inspiratory pressure sensor
O ₂ Mixer	Air/oxygen mix chamber	F4	Inspiration port filter
OS	O ₂ sensor	Humidifier	Humidifier
RV1	110 cmH ₂ O pressure relief valve	WT1 WT2	Water trap
F10,F11	Bacteria filter	F12	Expiratory port filter
SOL2, SOL3	Pressure zeroing three-way valve	NCV	Nebulization control valve
PQ3	Pressure difference sensor	R1	Nebulization limb air resistance
PE	Expiratory pressure sensor	Nebulizer	Nebulizer
EV	Expiration valve	3Way Valve1	Three-way valve 1
Q3	Expiratory flow sensor	Proximal Flow	Proximal flow sensor
CV4	Check valve	F1	Dust-proof filter
R2, R3	Resistor	F2	HEPA filter

R4, R5	Resistor	Pfilter	Vacuum sensor
Pprox	Pressure difference sensor	SD1	Noise reduction and air/oxygen mix chamber
RV2	758kPa pressure relief valve	CV5	Check valve

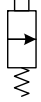
Note: the nebulizer mentioned in this manual shall be the legal product with medical device certificate registered in the People's Republic of China. This requirement applies to nebulizers mentioned in other places than here.

A.1.3 Definition of Symbols

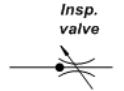
	Gas supply		Filter
	Water trap		Humidifier
	Regulator		Switch valve (dual position, two-way solenoid valve)
	O ₂ sensor		Pressure sensor
	Check valve		Resistor
	Nebulizer		Flow sensor
	Dual position, three-way solenoid valve		Proportional solenoid valve
	Temperature sensor		Backup Air Supply Fan
	Air inlet negative pressure sensor		Backup Air Supply Heat Exchanger
	Inspiration valve	/	/

A.1.4 Pneumatic System Overview

The pneumatic circuit system includes four parts, namely the inspiratory limb, patient tubing, expiratory limb and backup air supply module. The inspiratory limb system can be disassembled into the gas supply subsystem, flow control subsystem, safety valve subsystem and nebulization control subsystem.

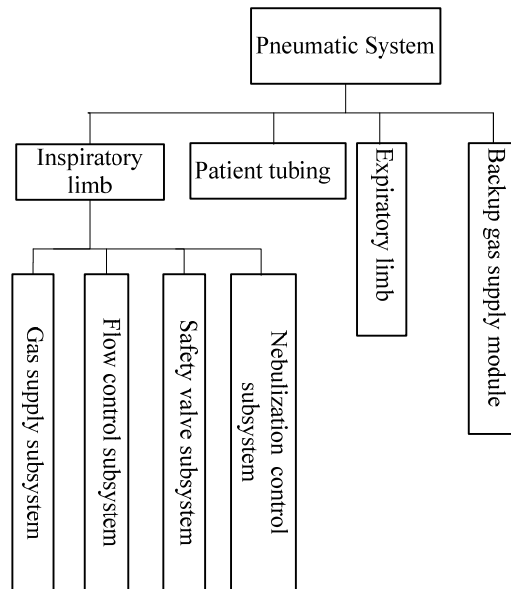

As shown above, patient tubing is the bridge connecting the inspiratory limb and the expiratory limb. Meanwhile, the gas supply and the nebulization subsystems also can be connected to the patient tubing to perform the nebulization function. These systems together constitute a closed circuit to conduct ventilation management functions.

The gas supply subsystem is the first part of the pneumatic circuit, and its main function is to draw the external air and oxygen supplies into the machine. As the pressure of the external gas supply is relatively high and unstable, with certain impurities, a 5 μm filter has been provided in the air supply subsystem. As the pressure of the external oxygen supply is relatively high and unstable, a pressure regulation valve has been provided in the air supply subsystem to protect the precision solenoid valve and flow sensor in the flow control module at the back-end. Meanwhile, a pressure sensor has been provided to monitor the air supply pressure, as well as a check valve to prevent the reflux of the gas inside the ventilator to other external air supply.

The gas supply inlet connector is designed as NIST/DISS optional type to prevent incorrect connection. The pressure regulation valve at the back-end of the gas supply inlet reduces the gas supply pressure to ensure the output of the proportional solenoid valve PSOL is stable and maintains relatively good reproducibility.

The flow control subsystem is mainly responsible for the accurate control and monitoring of the flow and concentration of oxygen inhaled by the patient, with the proportional solenoid valve performing the control function and a flow sensor performing the monitoring function. Two parallel limbs, the oxygen limb and air limb, are included.

The nebulization control subsystem is mainly responsible for the control of the pneumatic nebulizer. NCV is a two-way solenoid valve with two states, on and off. Resistor R1 is a pinhole, which, when NVC is turned on, provides 2.25 bar oxygen at the front-end and continuous flow at the back-end required by nebulization. The flow enters the nebulizer through the nebulizer connector at the front of the ventilator, aerosolizes the drug and ultimately flows to the patient.

The main function of the air supply module subsystem is to prevent gas supply failure from the main gas supply and serve as a backup gas supply module to supply gas to the ventilator. The subsystem includes a pilot valve-driven three-way valve. The valve's main function is to switch oxygen. When the pipeline gas supply is normal, the oxygen enters the oxygen mixing chamber through the three-way valve to be mix with air. When pipeline gas supply fails, the oxygen enters the backup air supply module through 3-way valve and mixes with the air through backup air supply module to form an oxygen/air gas mixture, which flows out from the backup air supply module into the O₂ flow sensor and then into the oxygen mixing chamber.

The expiration module is mainly responsible for functions such as pressure control, pressure monitoring and flow monitoring of the patient's expiratory phase. The main difference from the inspiration module is that all the gases flowing through are exhaled by the patient. Thus, the various components of the expiration module must be cleaned and disinfected before being reused.

The expiratory valve (EV) is electronically-controlled, and maintains the valve-sealing pressure of the expiratory valve through an electrical machine.

Regardless of the ventilator frame, patient tubing is located the ventilator's peripheral pneumatic circuit, and different configurations may be selected according to requirements. Its main function is to connect the ventilator to the patient, and to humidify the gas inhaled by a patient.

The patient tubing is divided into two types, disposable and reusable. Disposable tubing generally integrates the tubing, water trap and Y piece. It is made of PVC material, and as such has a relatively low cost and may be disposed of after a single use. Generally, silica gel is the material employed by reusable tubing, which can withstand repeated autoclave disinfection. The water trap and the Y piece also can withstand repeated autoclave disinfection.

With a humidifier placed in the inspiratory tubing, the dry gas mixture emitted by the ventilator is converted into warm saturated gas after passing through the humidifier, and then enters the patient's respiratory tract, thus avoiding patient discomfort and complications.

The nebulizer is connected to the nebulizing air tap on the front panel of the machine. The function of the nebulizer is to transform the nebulized liquid drug into colloidal particles, which enter the patient's respiratory tract and lungs when the patient inhales to achieve therapeutic goals.

A.2 Electrical System

A.2.1 Electrical System Structure Diagram

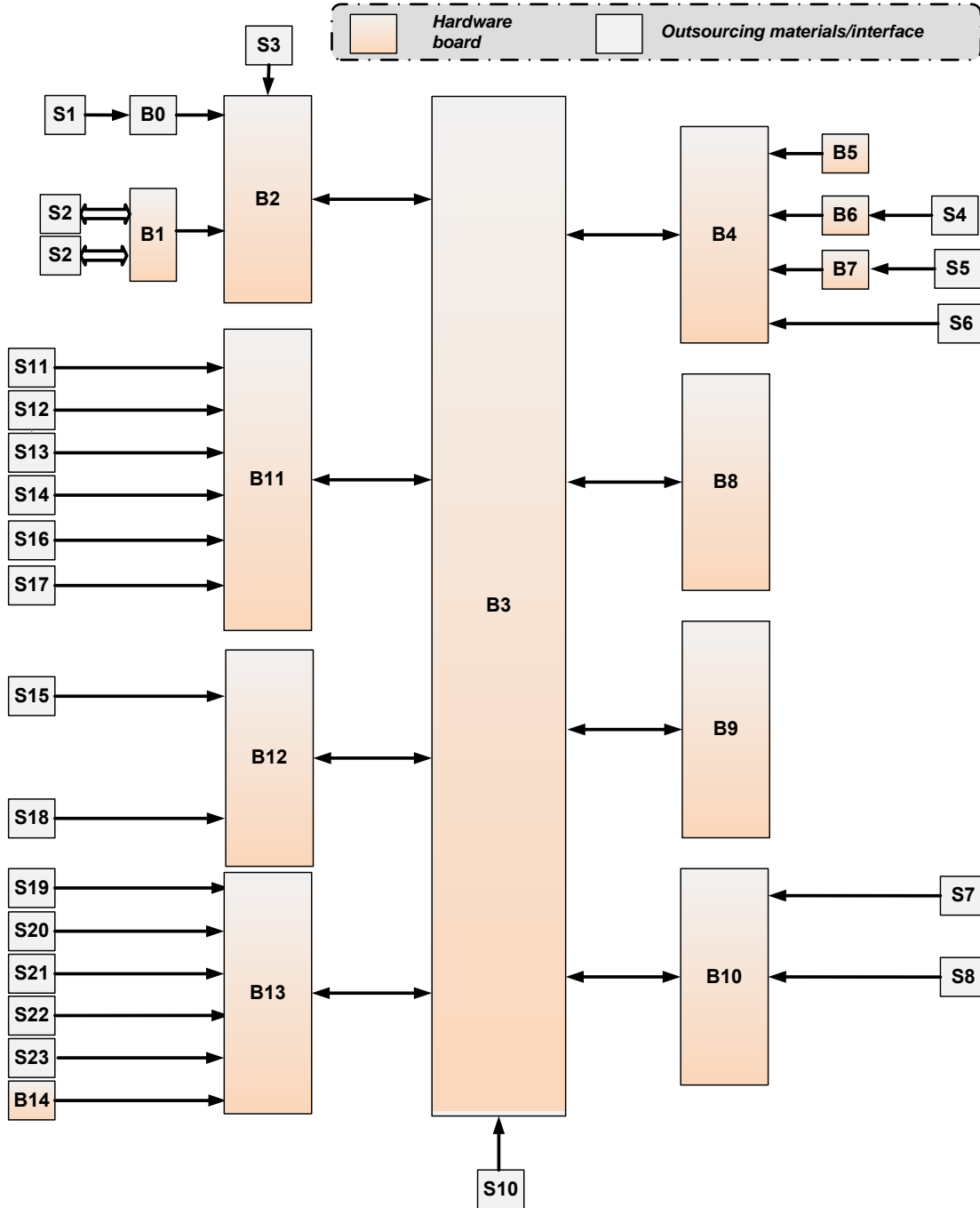

A.2.2 Parts List

S1	Total AC input and fuse	S10	High-precision monitoring module (or called the neonate module)
B0	AC-DC power module	S11	O ₂ sensor
S2	Battery	S12	Air proportional valve
B1	Battery adapter board	S13	Oxygen proportional valve
B2	DC-DC power board	S14	Nebulizing valve
S3	Power module radiator fan	S15	Safety valve
B3	Motherboard	B12	Sensor adapter board
B4	Main control board	S16	Oxygen limb flow sensor
B5	Alarm light board	S17	Air limb flow sensor
B6	Touch screen control board	B13	Backup air supply module drive board
B7	Key and coder board	S18	Expiration proportional valve
S4	Touch screen	S19	Backup Air Supply
S5	Coder	S20	Radiator fan
S6	Display	S21	External temperature sensor
B8	Monitoring module	S22	Large-diameter proportional valve
B9	Protection module	S23	Gas supply-switching three-way valve
B10	Infrared communication board	B14	Vacuum sensor board
S7	CO ₂ Module	B11	Air supply pressure adapter board
S8	SpO ₂ module	/	/

B Product Specifications

The ventilator is already integrated with an expiratory volume monitor, pressure measurement device, pressure release device, built-in gas mixer, alarm system, SpO₂ monitor, O₂ monitor, and CO₂ monitor. Among them:

- The expiratory volume monitor, pressure measurement device, and pressure release device comply with ISO 80601-2-12.
- The alarm system complies with IEC 60601-1-8.
- The gas mixer complies with ISO 11195.
- The SpO₂ monitor complies with ISO 80601-2-61;
- The O₂ monitor complies with ISO 80601-2-55.
- The CO₂ monitor complies with ISO 80601-2-55.
- The gas supply hose assembly complies with ISO 5359.

B.1 Safety Specifications

Type of protection against electric shock	Ventilator: Class I device with internal electrical power supply. Air compressor: Class I device.
Degree of protection against electric shock	Ventilator: Mixed BF and CF applied part type, with respiratory circuit, and CO ₂ being BF type, and SpO ₂ being CF type. Air compressor: No applied part.
Operating mode	Continuous
Degree of protection against hazards of explosion	Ordinary equipment, without protection against explosion; not for use with flammable anaesthetics.
Degree of protection against harmful ingress of water	Ventilator: Degrees of protection provided by enclosures(IP Code)—IP21 Air compressor: Degrees of protection provided by enclosures(IP Code)—IPX0 Protection Index according the EN 60529 standard: 2: Protected against solid foreign objects of 12.5 mm diameter and greater 1: Protected against vertically falling water drops 0: no protection
Disinfection and sterilization methods.	Ventilator: The device disinfection and sterilization methods are recommended by manufacturer. Air compressor: The device does not require disinfection and sterilization.
Equipment type	Mobile

B.2 Environmental Specifications

Main unit			
Item	Temperature (°C)	Relative humidity (non-condensing)	Barometric pressure (kPa)
Operating	10 to 40	10 to 95 % R.H.	50 to 106
Storage	-20 to 60	10 to 95 % R.H.	50 to 106
Backup Air Supply			
Item	Temperature (°C)	Relative humidity (non-condensing)	Barometric pressure (kPa)
Operating	10 to 40	10 to 95 % R.H.	62 to 106 ¹
Storage	-20 to 60	10 to 95 % R.H.	50 to 106
Air Compressor			
Item	Temperature (°C)	Relative humidity (non-condensing)	Barometric pressure (kPa)
Operating	10 to 40	15 to 95 % R.H.	50 to 106
Storage	-20 to 60	10 to 95 % R.H.	50 to 106
Paramagnetic Oxygen Sensor			
Item	Temperature (°C)	Relative humidity (non-condensing)	Barometric pressure (kPa)
Operating	10 to 40	10 to 95 % R.H.	54 to 106
Storage	-20 to 60	10 to 95 % R.H.	50 to 106
Chemical Oxygen Sensor			
Item	Temperature (°C)	Relative humidity (non-condensing)	Barometric pressure (kPa)
Operating	10 to 40	10 to 95 % R.H.	50 to 106
Storage	-20 to 50	10 to 95 % R.H.	50 to 106

¹ Note: 800 hPa to 1060 hPa output pressure should reach 80 cmH₂O, 620 hPa to 800 hPa output pressure should reach 60 cmH₂O.

B.3 Power Requirements

External AC power supply	
Input voltage	100 to 240 V~
Input frequency	50/60 Hz
Input current	2.8 to 1.2 A
Fuse	T5 AH/250 V
Internal battery	
Number of batteries	One or two
Battery type	Lithium-ion battery
Battery capacity	5600 mAh with a single battery 11200 mAh with two batteries
Time to shutdown	10 min at least (powered by new fully-charged batteries after the first low battery alarm)
Minimum battery run time	90 min (powered by one new fully-charged battery in standard working condition); 180 min (powered by two new fully-charged batteries in standard working condition).

Ventilator's standard working condition is:

- Gas supply type: medical gas circuit system
- Ventilation mode :volume controlled ventilation;
- TV: 500 mL;
- f: 10/min;
- I:E: 1 :2;
- O₂% : 40 Vol.%;
- PEEP: 3 cmH₂O;
- Resistance: 5 cmH₂O/(L/s)±10%;
- Compliance: 50 mL/cmH₂O±5%.

B.4 Physical Specifications

System noise	
System noise	A-weighted sound pressure level (L_{pA}) ≤ 45 dB(A) A-weighted sound power level (L_{WA}) ≤ 53 dB (A)
Overall Dimensions	
Dimensions	(1375 \pm 5)mm \times (534 \pm 5)mm \times (687 \pm 5)mm (height \times width \times depth, whole machine) (600 \pm 5)mm \times (330 \pm 5)mm \times (293 \pm 5)mm (height \times width \times depth, including the main unit and backup air supply) (378 \pm 5)mm \times (330 \pm 5)mm \times (293 \pm 5)mm (height \times width \times depth, including the main unit) Note: The whole machine including the main unit (with one battery), display, trolley, excluding breathing tubes, module, support arm and humidifier.
Weight	≤ 18 kg (including the main unit (with one battery)) ≤ 25 kg (including the main unit and backup air supply) ≤ 40 kg (whole machine, excluding the backup air supply) ≤ 48 kg (whole machine and backup air supply) Note: The whole machine including the main unit (with one battery), display, trolley, excluding breathing tubes, module, support arm and humidifier.
Caster	
Caster	Four casters. All casters have brakes.
Display	
Type	TFT display
Dimensions	18.5"
Resolution	1920 x 1080 pixels
Touch screen	Available
Adjustable angle	Rotate 270 degrees left and right; Rotate 45 degrees up and down.
LED indicator	
Alarm LED	One (yellow and red. When high and medium priority alarms occur simultaneously, it flashes red only).
External power LED	One (green; lit when the external power supply is connected).
Battery indicator light	One (green; Lit when batteries are installed and external power supply is connected; flashing when powered by batteries; extinguished when no batteries are installed or when the ventilator is powered off).

Operating status LED	One, namely, power switch key background light (green; Lit when power on, and off when power off.)
Audio indicator	
Speaker	Gives off alarm tones and key tones; supports multi-level tone modulation. The alarm tones comply with the requirements of IEC 60601-1-8.
Buzzer	Gives off auxiliary audio alarm in case of speaker malfunction.
Connector	
Network connector	A connector which supports connection with a PC to perform software upgrade and connection with external medical and information device.
USB connector	Use USB device to conduct ventilator software upgrade, export captured screen, export configuration information and historical data (such as patient data, alarm log, calibration table), transfer configuration data between machines of the same type, and connect the electronic nebulizer with USB interface.
RS-232 connector	Connects to the external calibration device for calibrating pressure. An external medical device can be connected via this connector to communicate with the ventilator.
Nurse call connector	Connects to the hospital's nurse call system.
VGA connector	Outputs VGA video signals with the same contents to the primary display and connects to the external display (supporting display with resolution of 1920*1080).

B.5 Pneumatic System Specifications

Gas supply	
Gas type	Air, oxygen
Pressure range	280 to 650 kPa
Rated flow requirement	180 L/min
Input Connector	NIST
Gas supply requirements	Medical compressed oxygen and medical compressed air
Inspiration module	
Maximum flow	Not less than 180 L/min (BTPS)
Nebulizer connector flow	7 L/min to 10 L/min
Safe pressure of respiration system	≤ 12.5 kPa
Inspiratory outlet	Coaxial 22 mm/15 mm conical connector

Expiration module	
Expiratory outlet	Coaxial 22 mm/15 mm conical connector
System compliance and resistance	
Compliance	<p>Adult disposable circuit (including inspiratory safety valve, adult disposable patient tubing, water trap, expiratory valve): ≤ 4 mL/cmH₂O;</p> <p>Adult reusable circuit (including inspiratory safety valve valve, adult reusable patient tubing, water trap, expiratory valve, Y piece): ≤ 2 mL/cmH₂O;</p> <p>Pediatric disposable circuit (including inspiratory safety valve, pediatric disposable patient tubing, water trap, expiratory valve): ≤ 2 mL/cmH₂O;</p> <p>Pediatric reusable circuit (including inspiratory safety valve, pediatric reusable patient tubing, water trap, expiratory valve, Y piece): ≤ 2 mL/cmH₂O;</p> <p>Neonate disposable circuit (including inspiratory safety valve, neonate reusable patient tubing, water trap, expiratory valve, Y piece, neonatal flow sensor): ≤ 1 mL/cmH₂O.</p>
Inspiration Resistance	<p>Not greater than 6 cmH₂O at 60 L/min flow (adult patient tubing)</p> <p>Not greater than 6 cmH₂O at 30 L/min flow (pediatric patient tubing)</p> <p>Not greater than 6 cmH₂O at 5 L/min flow (neonate patient tubing)</p>
Expiration Resistance	<p>Not greater than 6 cmH₂O at 60 L/min flow (adult patient tubing)</p> <p>Not greater than 6 cmH₂O at 30 L/min flow (pediatric patient tubing)</p> <p>Not greater than 6 cmH₂O at 5 L/min flow (neonate patient tubing)</p>
Bacterial filter	<p>Resistance: < 2 cmH₂O at 60 L/min</p> <p>Particle size: Captures particles of 0.3 mm (micron) with $> 99.99\%$ efficiency</p> <p>Dead space: < 80 mL</p>
Leakage	
Leakage	<p>Not greater than 200 mL/min@50 cmH₂O (adult tubes)</p> <p>Not greater than 100 mL/min@40 cmH₂O (pediatric tubes)</p> <p>Not greater than 50 mL/min@20 cmH₂O (neonate tubes)</p>

B.6 Ventilator Specifications

Controlled parameters			
Parameter	Range	Step size	Unit
O ₂ %	21 to 100	1	Vol. %
TV	Adult: 100 to 4000 Pediatric: 20 to 300 Neonate: 2 to 100	2 to 10: 0.1 10 to 50: 0.5 50 to 100: 1 100 to 4000: 10	mL
f	Neonate: 1 to 150 Adult/Pediatric: 1 to 100	1	/min
fsimv	1 to 60	1	/min
T _{insp}	0.10 to 10.00	0.10 to 1.00: 0.01 1.00 to 10.00: 0.05	s
I:E	4:1 to 1:10	0.5	/
T _{slope}	0.00 to 2.00	0.05	s
PEEP	0 to 50	1	cmH ₂ O
ΔP _{insp}	High pressure gas supply: 1 to 100; Backup air supply: 1 to 80.	1	cmH ₂ O
ΔP _{supp}	High pressure gas supply: 0 to 100; Backup air supply: 0 to 80. In PSV-S/T mode or PSV mode (neonate NIV ventilation) High pressure gas supply: 1 to 100; Backup air supply: 1 to 80.	1	cmH ₂ O
Phigh	High pressure gas supply: 0 to 100; Backup air supply: 0 to 80.	1	cmH ₂ O
P _{low}	0 to 50	1	cmH ₂ O
Thigh	0.10 to 30.00	0.10 to 1.00: 0.01 1.00 to 30.00: 0.05	s
T _{low}	0.20 to 30.00	0.20 to 1.00: 0.01 1.00 to 30.00: 0.05	s

F-Trig	Neonate: 0.1 to 5.0 Adult/Pediatric: 0.5 to 20.0, Off	0.1	L/min
P-Trig	-0.5 to -20.0, Off	0.5	cmH ₂ O
Exp%	Auto, 5 to 85 Auto, 1 to 85 (optional)	5 to 85: 5 1 to 5: 1 (optional)	%
fapnea	Neonate: 1 to 150 Adult/Pediatric: 1 to 100	1	/min
ΔPapnea	High pressure gas supply: 1 to 100; Backup air supply: 1 to 80.	1	cmH ₂ O
TVapnea	Adult: 100 to 4000 Pediatric: 20 to 300 Neonate: 2 to 100	2 to 10: 0.1 10 to 50: 0.5 50 to 100: 1 100 to 4000: 10	mL
Apnea Tinsp	0.10 to 10.00	0.10 to 1.00: 0.01 1.00 to 10.00: 0.05	s
Δint.PEEP	1 to 40, OFF	1	cmH ₂ O
Flow (O ₂ Therapy)	Adult: 2 to 60 Pediatric: 2 to 25 Neonate: 2 to 20	1	L/min
Flow	Adult: 6 to 180 Pediatric: 6 to 30 Neonate: 2 to 30	2 to 10: 0.1 10 to 180: 1.0	L/min
Tpause(%)	OFF, 5 to 60	5	%
PEEP (nCPAP mode)	0 to 50	1	cmH ₂ O
MV%	25 to 350	1	%
Tube I.D.	Adult: 5.0 to 12.0 Pediatric: 2.5 to 8.0 Neonate: 2.5 to 5.0	0.5	mm
Compensate	1 to 100	1	%
Interval	20s to 180min	20s to 59s:1s 1min to 180min:1min	/
Cycles Sigh	1 to 20	1	/
Neg.Plimit	-30 to 0	1	cmH ₂ O
Weight			
Adult	10 to 200	1	kg
Pediatric	3 to 35	0.1	kg
Neonate	0.2 to 15	<3: 0.01 >3: 0.1	kg

Monitored parameters			
Parameter	Range	Resolution	Unit
Ppeak	-20 to 120	Absolute value < 10 cmH ₂ O:	cmH ₂ O
Pplat		0.1	
Pmean		Absolute value ≥ 10 cmH ₂ O: 1	
TVi	0 to 6000 (BTPS)	< 100 mL: 0.1	mL
TVe		≥ 100 mL: 1	
TVe spn			
MV	Adult/Pediatric: 0.0 to	< 10.0 L/min: 0.01 ≥ 10.0 L/min: 0.1	L/min
MVspn	100.0		
MVleak	Neonate: 0.0 to 30.0		
ftotal	0 to 200	1	/min
fmand			
fspn			
PEEP	0 to 120	< 10 cmH ₂ O: 0.1 ≥ 10 cmH ₂ O: 1	cmH ₂ O
I:E	150:1 to 1:150	0.1	/
Tinsp	0.00 to 60.00	0.01	s
Ri	0 to 600	1	cmH ₂ O/(L/s)
Re			
Cstat	0 to 300	< 10 mL/cmH ₂ O: 0.1	mL/cmH ₂ O
Cdyn		≥ 10 mL/cmH ₂ O: 1	
TVe/IBW	0 to 50	0.1	/
RSBI	0 to 9999	1	1/(L•min)
PEEPi	0 to 120	0.1	cmH ₂ O
NIF	-45.0 to 0.0	0.1	cmH ₂ O
FiO ₂	15 to 100	1	Vol. %
P0.1	-20.0 to 0.0	0.1	cmH ₂ O
PIF	Adult/Pediatric: 0 to 300 Neonate: 0 to 30	< 100 L/min: 0.1 ≥ 100 L/min: 1	L/min
PEF	Adult/Pediatric: 0 to 180 Neonate: 0 to 30	< 100 L/min: 0.1 ≥ 100 L/min: 1	L/min
C20/C	0.00 to 5.00	0.01	/
RCexp	0.0 to 10.0	0.01	s
Flow (O ₂ Therapy)	0.0 to 100.0	0.1	L/min
WOBtot	0.0 to 100.0	0.01	J/min
WOBvent			
WOBimp			
WOBpat			

EEF	Adult/Pediatric: 0 to 180 Neonate: 0 to 30	<100 L/min: 0.1 ≥100 L/min: 1	L/min
Vtrap	0 to 4000	≤100 mL: 0.1 >100 mL: 1	mL
Leak%	0 to 100	1	%
PtpI	-99 to 99	Absolute value < 10 cmH ₂ O: 0.1 Absolute value ≥ 10 cmH ₂ O: 1	cmH ₂ O
PtpE			
ΔPtp			
ΔPes			
PesI	-40 to 120	Absolute value < 10 cmH ₂ O: 0.1 Absolute value ≥ 10 cmH ₂ O: 1	cmH ₂ O
PesE			
Paux2I			
Psux2E			

B.7 Ventilator Accuracy

Control accuracy	
FiO ₂	± (3 Vol.% +1% of set value)
TV	Neonate: 2 mL to 100 mL: ± (2 mL+ 10% of set value) Pediatric: 20 mL to 300 mL: ± (10 mL+ 10% of set value) Adult: 20 mL to 4000 mL: ± (10 mL+ 10% of set value)
f	1/min to 100/min: ± 1/min Other range: ±2% of set value
fsimv	± 1/min
T _{insp}	± 0.1 s or ±10% of set value, whichever is greater
I:E	2:1 to 1:4: 10% of set value Other range: ±15 % of set value
T _{slope}	± 0.2 s or ±20% of set value, whichever is greater
PEEP	± (2.0 cmH ₂ O + 5 % of set value)
ΔP _{insp}	± (2.0 cmH ₂ O + 5 % of set value)
ΔP _{supp}	± (2.0 cmH ₂ O + 5 % of set value)
Phigh	± (2.0 cmH ₂ O + 5 % of set value)
P _{low}	± (2.0 cmH ₂ O + 5 % of set value)
Thigh	± 0.2 s or ±10% of set value, whichever is greater
T _{low}	± 0.2 s or ±10% of set value, whichever is greater
F-trig:	Neonate: 0.1 L/min to 5.0 L/min: ± (0.2 L/min + 10% of set value); Adult/Pediatric: 0.5 L/min to 20.0 L/min: ± (1 L/min + 10% of set value);

P-Trig	$\pm (1.0 \text{ cmH}_2\text{O} + 10\% \text{ of set value})$
Exp%	$\pm 10\%$ (absolute error)
fapnea	1/min to 100/min: $\pm 1/\text{min}$ Other range: $\pm 2\%$ of set value
Δ Papnea	$\pm (2.0 \text{ cmH}_2\text{O} + 5\% \text{ of set value})$
TVapnea	Neonate: 2 mL to 100 mL: $\pm (2 \text{ mL} + 10\% \text{ of set value})$ Adult/Pediatric: 20 mL to 4000 mL: $\pm (10 \text{ mL} + 10\% \text{ of set value})$
Apnea Tinsp	$\pm 0.1 \text{ s}$ or $\pm 10\%$ of set value, whichever is greater
Flow (O_2 Therapy)	$\pm (2 \text{ L/min} + 10\% \text{ of set value})$
Flow	$\pm 1 \text{ L/min}$ or 20% of set value, whichever is greater.
Tpause(%)	$\pm 5\%$ (absolute error, not applicable if Tpause(%) is less than 0.1 s)
PEEP (nCPAP mode)	$\pm (2.0 \text{ cmH}_2\text{O} + 5\% \text{ of set value})$
MV%	$\pm 10\%$ (absolute error) or $\pm 10\%$ of set value, whichever is greater.
Δ int.PEEP	$\pm (2.0 \text{ cmH}_2\text{O} + 5\% \text{ of set value})$
Neg.Plimit	$\pm (2.0 \text{ cmH}_2\text{O} + 5\% \text{ of set value})$
Monitoring accuracy	
Ppeak	$\pm (2 \text{ cmH}_2\text{O} + 4\% \text{ of the actual reading})$
Pplat	
Pmean	
PEEP	
TVi	Neonate:
TVe	0 mL to 6000 mL: $\pm (2 \text{ mL} + 8\% \text{ of actual reading})$. Adult/Pediatric:
TVe spn	0 mL to 100 mL: $\pm (10 \text{ mL} + 3\% \text{ of actual reading})$. 100 mL to 6000 mL (not including 100 mL): $\pm (5 \text{ mL} + 8\% \text{ of actual reading})$.
MV	Adult/Pediatric:
MVspn	0.0 L/min to 100.0 L/min: $\pm (0.2 \text{ L/min} + 10\% \text{ of actual reading})$. Neonate:
MVleak	0.0 L/min to 30.0 L/min: $\pm (0.15 \text{ L/min} + 8\% \text{ of actual reading})$.
ftotal	$\pm 1/\text{min}$ or 5% of actual reading, whichever is greater.
fmand	
fspn	
I:E	$\pm 6\%$ (not applicable if Tinsp or Texp is less than 50 ms).
Tinsp	$\pm 0.05 \text{ s}$.
Ri	0 $\text{cmH}_2\text{O}/(\text{L/s})$ to 20 $\text{cmH}_2\text{O}/(\text{L/s})$, $\pm 10 \text{ cmH}_2\text{O}/(\text{L/s})$;
Re	Other range: $\pm 50\%$ of actual reading.

Cstat	± 10 mL/cmH ₂ O or ± 20% of actual reading, whichever is greater.
Cdyn	
TVe/IBW	Calculation parameter, refer to the accuracy of TVe.
RSBI	±20 1/(L•min) or ±15% of displayed value, whichever is greater.
NIF	± (2 cmH ₂ O + 4% of the actual reading).
PEEPi	± (2 cmH ₂ O + 4% of the actual reading).
FiO ₂ *	± (2.5 vol. % + 2.5% of actual reading).
P0.1	± (2 cmH ₂ O + 4% of the actual reading).
PIF	±1 L/min or 20% of actual reading, whichever is greater.
PEF	±1 L/min or 20% of actual reading, whichever is greater.
C20/C	± 0.2 or ± 10%, whichever is greater.
Flow (O ₂ Therapy)	± (2 L/min + 10% of actual reading).
WOBtot	± (1 J/min + 15% of actual reading).
WOBvent	
WOBimp	
WOBpat	
RCexp	± (0.2 s + 20 % of actual reading).
EEF	±1 L/min or 20% of actual reading, whichever is greater.
Vtrap	± (5 mL + 8% of actual reading)
Leak%	± 10 % (absolute error)
PtpI	± (2 cmH ₂ O + 4% of actual reading)
PtpE	± (2 cmH ₂ O + 4% of actual reading)
ΔPtp	± (2 cmH ₂ O + 4% of actual reading)
ΔPes	± (2 cmH ₂ O + 4% of actual reading)
PesI	± (2 cmH ₂ O + 4% of actual reading)
PesE	± (2 cmH ₂ O + 4% of actual reading)
Paux2I	± (2 cmH ₂ O + 4% of actual reading)
Psux2E	± (2 cmH ₂ O + 4% of actual reading)

FiO₂*: the drifting test method for testing accuracy specified in the standard ISO 80601-2-55 can ensure the measurement accuracy meets the requirement in this table.

B.8 Alarm

B.8.1 Settable Alarms

Alarm Settings				
Parameter		Setting range	Adjust step length	Notes
MV	High alarm limit	Adult: 0.2 L/min to 100.0 L/min; Pediatric: 0.2 L/min to 60.0 L/min; Neonate: 0.02 L/min to 30.0 L/min, in the nCPAP ventilation mode, it can be set to off.	0.02 to 1.0: 0.01 L/min, 1.0 to 100.0 L/min: 0.1 L/min.	Set the high alarm limit to be greater than low alarm limit.
	Low alarm limit	Adult: 0.1 L/min to 50.0 L/min; Pediatric: 0.1 L/min to 30.0 L/min; Neonate: 0.01 L/min to 15.0 L/min, in NIV mode, it can be set to off.	0.01 to 1.0: 0.01 L/min, 1.0 to 50.0 L/min: 0.1 L/min.	
TV	High alarm limit	Adult: Off, 110 to 6000 mL; Pediatric: Off, 25 mL to 600 mL; Neonate: Off, 3 mL to 200 mL.	3 mL to 100 mL: 1 mL, 100 mL to 6000 mL: 5 mL.	
	Low alarm limit	Adult: Off, 50 to 5995 mL; Pediatric: Off, 10 to 595 mL; Neonate: Off, 1 mL to 195 mL.	1 mL to 100 mL: 1 mL, 100 mL to 6000 mL: 5 mL.	
Paw	High alarm limit	10 cmH ₂ O to 105 cmH ₂ O	1 cmH ₂ O	
	Low alarm limit	Off, 1 cmH ₂ O to 100 cmH ₂ O;	1 cmH ₂ O	
f	High alarm limit	Off, 2/min to 160/min	1/min	
	Low alarm limit	Off, 1/min to 159/min	1 /min	
Tapnea		5 s to 60 s, in the nCPAP ventilation mode, it can be set to off.	1 s	Error is ± 3 s.

Note: When the alarm limit in the above table is set to off, the display screen interface will

show the alarm off icon



B.8.2 Internal Alarms

Parameter		Alarming condition	Notes
FiO ₂	High alarm limit	Internal alarm limit: min (FiO ₂ set value + max (7 Vol.% or FiO ₂ set value × 10%), 100 Vol.%).	Set the high alarm limit to be greater than low alarm limit.
	Low alarm limit	Internal alarm limit: max (18 vol.%, FiO ₂ set value minus max (7 vol.%, FiO ₂ set value × 10%))	
Sustained Airway Pressure		Internally set alarm limit: PEEP+15 cmH ₂ O The alarm limit is exceeded for 15 s continuously.	

B.9 Special Function

Function
Inspiration Hold
Expiration Hold
Oxygen enrichment
Sputum Suction
Nebulization
Manual Breath
Intrinsic PEEP
Automatic Tube Resistance Compensation (ATRC)
Dynamic lung display function
P-V Tool
Recruitment Tool
Weaning tools
Auxiliary pressure function
CO ₂ -related function
Oxygen Therapy

B.10 CO₂ Module Specifications

B.10.1 Sidestream CO₂ Module

Sidestream CO ₂ Module	
Measurement range	0.0 to 20.0 vol.% (0 to 152 mmHg)
Resolution	0.1 vol.% (1mmHg)
Accuracy	0.0 vol.% to 5.0 vol.% (0 mmHg to 40 mmHg) : ± 0.25 vol.% (±2 mmHg)
	5.0 vol.% to 10.0 vol.% (41 mmHg to 76 mmHg) (not including 5.0 vol.%) : ± 5% of actual reading
	10.0 vol.% to 20.0 vol.% (77 mmHg to 152 mmHg) (not including 10.0 vol.%) : ± 10% of actual reading
Monitored parameters	Parameters: MVCO ₂ Range: 0 to 9999 mL/min Resolution: 1 mL/min
Measurement accuracy drift	The test method of the standard ISO 80601-2-55 can ensure the measurement accuracy meets the requirement in this table.
Sampling rate	Sampling rate is 50 mL/min, when low flow sidestream accessories (adult and pediatric) are used; Sampling rate is 120 mL/min, when adult water trap and accessories are used; Sampling rate is 90 mL/min, when pediatric water trap and accessories are used; Accuracy: ±15 mL/min or ±15% of set value, whichever is greater
Rise time	Adult/pediatric water trap: <300 ms @ 120 mL/min; Neonatal water trap: <330 ms @ 90 mL/min.
Total system response time	Neonatal water trap and sampling line are used: <4.5 s @ 90 mL/min; Adult/Pediatric water trap and sampling line are used: <5.5 s @ 120 mL/min.
Water trap cleaning time	CO ₂ Water trap cleaning time Adult/Pediatric water trap: ≥ 26 hours @ 120 mL/min; Neonatal water trap: ≥35 hours @ 90 mL/min. Note 2: (1) experimental condition: sampling gas temperature is 37°C, ambient temperature is 23°C, and sampling gas relative humidity is 100%. (2) water trap cleaning time ≥ 24 hours or 48 hours means that liquid level will not exceed max line within 24 hours or 48 hours respectively.

Sidestream CO ₂ alarm limits specification	Range	Step size	Notes
EtCO ₂ high alarm limit	2 to 152 mmHg	1 mmHg	Set the high alarm limit to be greater than the low alarm limit.
EtCO ₂ low alarm limit	0 to 150 mmHg		

Sidestream CO ₂ environmental specifications			
Item	Temperature (°C)	Relative humidity (non-condensing)	Barometric pressure (kPa)
Operating	5 to 40	15 to 95%	57.3 to 105.3
Storage	-20 to +60	10 to 95%	57.3 to 105.3

B.10.2 Mainstream CO₂ Module

Mainstream CO ₂ Module			
Measurement range	0.0 to 20.0 vol.% (0 to 150 mmHg)		
Resolution	0.1 vol.% (1mmHg)		
Accuracy	0.0 vol.% to 5.0 vol.% (0 mmHg to 40 mmHg) : ± 0.25 vol.% (±2 mmHg)		
	5.0 vol.% to 9.0 vol.% (41 mmHg to 70 mmHg) (not including 5.0 vol.%): ± 5% of actual reading		
	9.0 vol.% to 13.0 vol.% (71 mmHg to 100 mmHg) (not including 9.0 vol.%): ± 8% of actual reading		
	13.0 vol.% to 20.0 vol.%(101 mmHg to 150 mmHg)(not including 13.0 vol.%): ± 10% of actual reading		
Measurement accuracy drift	The test method of the standard ISO 80601-2-55 can ensure the measurement accuracy meets the requirement in this table.		
Monitored parameters	Parameters	Range	Resolution
	slopeCO ₂	0 to 9.99 % /L	0.01 % /L
	Vtalv	0 to 9999 mL	1 mL
	MValv	0 to 20 L/min	0.01 L/min for < 1 L/min 0.1 L/min for ≥ 1 L/min
	MVCO ₂	0 to 9999 mL /min	1 mL/min
	VDaw	0 to 999 mL	1 mL
	VDaw/TVe	0 to 100 %	1 %

	VeCO ₂	0 to 999 mL	1 mL
	ViCO ₂	0 to 999 mL	1 mL
	VDphy	0 to 999 mL	1 mL
	VDphy/TVe	0 to 100 %	1 %
	OI	0 to 200 mmHg, or 0 to 1500 kPa	0.1 or three significant digits
	P/F	0 to 800 mmHg, or 0 to 106 kPa	0.1 or three significant digits
Total system response time	<2.0 s		

Mainstream CO ₂ alarm limits	Range	Step size	Notes
EtCO ₂ high alarm limit	2 to 150 mmHg	1 mmHg	Set the high alarm limit to be greater than the low alarm limit.
EtCO ₂ low alarm limit	0 to 148 mmHg		

Mainstream CO ₂ environmental specifications			
Item	Temperature (°C)	Relative humidity (non-condensing)	Barometric pressure (kPa)
Operating	0 to 40	10 to 90%	57.3 to 105.3
Storage	-20 to 60	10 to 90%	53.3 to 107.4

B.11 SpO₂ Module Specifications

SpO ₂ Specifications	
*Measurement accuracy verification: The SpO ₂ accuracy has been verified in human experiments by comparing with arterial blood sample reference measured with a CO-oximeter. Pulse oximeter measurements are statistically distributed and about two-thirds of the measurements are expected to come with in the specified accuracy range compared to CO-oximeter measurements.	
Measurement range	0% to 100%
Resolution	1%
Accuracy	Adult/Pediatric: 70% to 100%: ± 2% Neonate: 70% to 100%: ± 3% 0% to 69%: No declaration
Data update period	≤ 30 s
Refreshing rate	≤ 2 s

*Studies were performed to validate the accuracy of Pulse Oximeter with SpO₂ sensors by contrast with a CO-Oximeter. The statistical analysis of data of this study shows the accuracy (Arms) is within the stated accuracy specification. Please see the following table.

Sensor type	Total	Data	Arms
512F (adult, finger type, reusable)	10 (4 male&6 female)	200 pairs	1.91 %
512H (pediatric, finger type, reusable)	10 (0 male&10 female)	200 pairs	1.95 %

The Pulse Oximeter with neonatal SpO₂ sensors was also validated on adult subjects.

Skin color	Gender	Number	Age(years)	Health
Black	Male	1	26 ± 3.14	Healthy
	Female	1		
Yellow	Male	3		
	Female	9		

PR Specifications

Measurement range	20 1/min to 300 1/min
Resolution	20 1/min
Accuracy	± 3 1/min

PI

Measurement range	0.05 % to 20 %
Resolution	0.05 to 9.99 %: 0.01 % 10.0 to 20.0 %: 0.1 %
Update cycle	SpO ₂ (70% to 100%): ≤30 s PR (20 1/min to 300 1/min): ≤30 s
Perfusion index range	0.05% to 20%

Alarm limit specification	Range	Step size	Notes
SpO ₂ high alarm limit	2 to 100%	1%	Set the high alarm limit to be greater than the low alarm limit.
SpO ₂ low alarm limit	0 to 98%		
Desat alarm	0% to 98%	1%	/
PR high alarm limit	17 1/min to 300 1/min	1 1/min	Set the high alarm limit to be greater than the low alarm limit.
PR low alarm limit	15 1/min to 298 1/min		

B.12 Air Compressor Specification

Air compressor specification		
Input voltage	220 V to 240 V	110 V to 120 V
Input frequency	50 Hz/60 Hz	60 Hz
Input current	3 A	6 A
Output pressure	300 to 450 kPa	
Noise	In normal operation, weighted average sound pressure level at one meter is not more than 50 dB(A).	
Continuous flow ²	When output pressure is 300 kPa, flow is ≥ 30 L/min.	
Peak flow in case of single supply gas(air)	Time with flow greater than 180 L/min is not below than 0.8 s at one bar of pressure.	
Dew point ³	When flow is 30 L/min, the temperature is 5°C less than room temperature.	

B.13 Backup Air Supply

Backup Air Supply	
Maximum output flow	≥ 200 L/min (BTPS)
Maximum output pressure	≥ 80 cmH ₂ O (≥ 80 cmH ₂ O @ 80kPa~106kPa (Barometric pressure); ≥ 60 cmH ₂ O @ 62kPa~80kPa (Barometric pressure))

² Output flow decreases as ambient pressure reduces under the same output pressure. Continuous flow may be lower than 30 L/min @ 300 kPa when as ambient pressure is lower than 70 kPa.

³ When ambient temperature is about 40°C and relative humidity is > 90% RH, the dew point may be lower than 5°C under continuous flow of 30 L/min.

FOR YOUR NOTES

C EMC

This equipment is in compliance with IEC 60601-1-2: 2014.

In the condition of immunity test required by IEC 60601-1-2: 2014, following essential performance is checked: TVi control accuracy, TVi monitoring accuracy, CO₂ monitoring accuracy, O₂ control accuracy, O₂ monitoring accuracy, and SpO₂ monitoring accuracy, MVCO₂ monitoring accuracy, MVO₂ monitoring accuracy.

NOTE

- **The ventilator needs special precautions regarding EMC and needs to be installed and put into service according to the EMC information provided below.**
 - **Use of portable or mobile communications devices will degrade the performance of the equipment.**
-

WARNING

- **Use of accessories, transducers and cables other than those specified or provided by the manufacturer of this equipment could result in increased electromagnetic emissions or decreased electromagnetic immunity of this equipment and result in improper operation.**
 - **Use of this equipment adjacent to or stacked with other device should be avoided because it could result in improper operation. If such use is necessary, this equipment and the other device should be observed to verify that they are operating normally**
 - **Portable RF communications equipment (including peripherals such as antenna cables and external antennas) should be used no closer than 30 cm (12 inches) to any part of the this equipment, including cables specified by the manufacturer. Otherwise, degradation of the performance of this equipment could result.**
 - **Other devices may interfere with this equipment even though they meet the requirements of CISPR.**
 - **When the input signal is below the minimum amplitude provided in technical specifications, erroneous measurements could result.**
-

Guidance and manufacture's declaration - electromagnetic emissions		
This equipment is intended for use in the electromagnetic environment specified below. The customer or the user of this equipment should assure that it is used in such an environment.		
Emissions test	Compliance	Electromagnetic environment - guidance
RF emissions CISPR 11	Group 1	This equipment uses RF energy only for its internal function. Therefore, its RF emissions are very low and are not likely to cause any interference in nearby electronic equipment.
RF emissions CISPR 11	Class B	This equipment is suitable for use in all establishments, including domestic establishments and those directly connected to the public low-voltage power supply network that supplies buildings used for domestic purposes.
Harmonic emissions IEC 61000-3-2	Class A	
Voltage fluctuations/flicker emissions IEC 61000-3-3	Complies	

Guidance and manufacture's declaration - electromagnetic immunity			
This equipment is suitable for use in the electromagnetic environment specified below. The customer or the user of this equipment should assure that it is used in such an environment.			
IMMUNITY test	IEC 60601 test level	Compliance level	Electromagnetic environment - guidance
Electrostatic discharge (ESD) IEC 61000-4-2	±8 kV contact ±15kV air	±8 kV contact ±15kV air	Floors should be wood, concrete or ceramic tile. If floors are covered with synthetic material, the relative humidity should be at least 30%.
Electrical fast transient/burst IEC 61000-4-4	±2 kV for power supply lines ±1 kV for input/output lines (length greater than 3 m)	±2 kV for power supply lines ±1 kV for input/output lines (length greater than 3 m)	Mains power quality should be that of a typical commercial or hospital environment.
Surge IEC 61000-4-5	±1 kV line(s) to line(s) ±2 kV line(s) to earth	±1 kV line(s) to line(s) ±2 kV line(s) to earth	Mains power quality should be that of a typical commercial or hospital environment.
Voltage dips and Voltage interruptions IEC 61000-4-11	0 % U_T for 0,5 cycle 0 % U_T for 1 cycle and 70 % U_T for 25/30 cycles 0 % U_T for 250/300 cycle	0 % U_T for 0,5 cycle 0 % U_T for 1 cycle and 70 % U_T for 25/30 cycles 0 % U_T for 250/300 cycle	Mains power quality should be that of a typical commercial or hospital environment. If the user of our product requires continued operation during power mains interruptions, it is recommended that our product be powered from an uninterruptible power supply or a battery.
RATED power frequency magnetic fields IEC 61000-4-8	30 A/m	30 A/m	Power frequency magnetic fields should be at levels characteristic of a typical location in a typical commercial or hospital environment.
Note: U_T is the AC. mains voltage prior to application of the test level.			

Guidance and Declaration - Electromagnetic Immunity			
This equipment is suitable for use in the electromagnetic environment specified below. The customer or the user of this equipment should assure that it is used in such an environment.			
Immunity test	IEC 60601 Test level	Compliance level	Electromagnetic environment - guidance
Conducted RF IEC 61000-4-6	3 Vrms 150k to 80 MHz	3 Vrms (V1)	Portable and mobile RF communications equipment should be used no closer to any part of the device, including cables, than the recommended separation distance calculated from the equation applicable to the frequency of the transmitter. Recommended separation distance:
	6 Vrms in ISM bands and amateur radio bands ^a between 0,15 MHz and 80 MHz	6 Vrms (V2)	
Radiated RF EM fields IEC 61000-4-3	3V/m 80 MHz to 2.7 GHz (for RGM, SpO ₂ performance)	3 V/m (E1)	$d = \left[\frac{3.5}{V1} \right] \sqrt{P}$ 150kHz to 80 MHz
	10V/m 80 MHz to 2.7 GHz (for ventilator function)	10 V/m	$d = \left[\frac{3.5}{E1} \right] \sqrt{P}$ 80 MHz to 800 MHz $d = \left[\frac{7}{E1} \right] \sqrt{P}$ 800 MHz to 2.7 GHz
Proximity fields from RF wireless communications equipment IEC61000-4-3	27 V/m 380 MHz to 390 MHz	27 V/m	where P is the maximum output power rating of the transmitter in watts (W) according to the transmitter manufacturer and d is the recommended separation distance in meters (m) ^b . Field strengths from fixed RF transmitters, as determined by an electromagnetic site survey ^c , should be less than the compliance level in each frequency range ^d . Interference may occur in the vicinity of equipment marked with the following symbol: 
	28 V/m 430 MHz to 470 MHz, 800 MHz to 960 MHz, 1700 MHz to 1990 MHz, 2400 MHz to 2570 MHz	28 V/m	
	9 V/m 704 MHz to 787 MHz, 5100 MHz to 5800 MHz	9 V/m	
Note 1: At 80 MHz and 800 MHz, the higher frequency range applies.			
Note 2: These guidelines may not apply in all situations. Electromagnetic propagation is affected by absorption and reflection from structures, objects and people.			

a. The ISM (industrial, scientific, and medical) bands between 150 kHz and 80 MHz are 6.765 MHz to 6.795 MHz; 13.553 MHz to 13.567 MHz; 26.957 MHz to 27.283 MHz; and 40.66 MHz to 40.70 MHz. The amateur radio bands between 0.15 MHz and 80 MHz are 1.8 MHz to 2.0 MHz, 3.5 MHz to 4.0 MHz, 5.3 MHz to 5.4 MHz, 7 MHz to 7.3 MHz, 10.1 MHz to 10.15 MHz, 14 MHz to 14.2 MHz, 18.07 MHz to 18.17 MHz, 21.0 MHz to 21.4 MHz, 24.89 MHz to 24.99 MHz, 28.0 MHz to 29.7 MHz and 50.0 MHz to 54.0 MHz.

b Compliance level in the ISM frequency bands between 150 kHz to 80 MHz and in the frequency range 80 MHz to 2.7 GHz are intended to decrease the likelihood that portable/ mobile communication equipment could cause interference if it is inadvertently brought into patient areas. For this reason, an additional factor of 10/3 is used in calculating the recommended separation distance for transmitters in these frequency ranges.

c Field strengths from fixed transmitters, such as base stations for radio (cellular/cordless) telephones and land mobile radios, amateur radio, AM and FM radio broadcast and TV broadcast cannot be predicted theoretically with accuracy. To assess the electromagnetic environment due to fixed RF transmitters, an electromagnetic site survey should be considered. If the measured field strength in the location in which this equipment is used exceeds the applicable RF compliance level above, this equipment should be observed to verify normal operation. If abnormal performance is observed, additional measures may be necessary, such as reorienting or relocating the device.

d Over the frequency ranges 150 kHz to 80 MHz, field strengths should be less than 3V/m.

Recommended Separation Distances between Portable and Mobile RF, Communications Equipment and This Equipment

This equipment is intended for use in an electromagnetic environment in which radiated RF disturbance are controlled. The customer or the user of this equipment can help prevent electromagnetic interference by maintaining a minimum distance between portable and mobile RF communications equipment (transmitters) and this equipment as recommended below, according to the maximum output power of the communication equipment.

Rated Maximum Output power of Transmitter Watts (W)	Separation Distance According to Frequency of Transmitter (m)		
	150 kHz to 80 MHz $d = \left[\frac{3.5}{V1} \right] \sqrt{P}$	80 MHz to 800 MHz $d = \left[\frac{3.5}{E1} \right] \sqrt{P}$	800 MHz to 2.7 GHz $d = \left[\frac{7}{E1} \right] \sqrt{P}$
0.01	0.12	0.12	0.23
0.1	0.38	0.38	0.73
1	1.20	1.20	2.30
10	3.80	3.80	7.30
100	12.00	12.00	23.00

For transmitters at a maximum output power not listed above, the recommended separation distanced in meters (m) can be determined using the equation applicable to the frequency of the transmitter, where P is the maximum output power rating of the transmitter in watts (W) according to the transmitter manufacturer.

Note 1: At 80 MHz and 800 MHz, the higher frequency range applies.

Note 2: These guidelines may not apply in all situations. Electromagnetic propagation is affected by absorption and reflection from structures, objects and people.

D Alarm Messages

This chapter lists physiological and technical alarm messages.

Note that in this chapter:

- Column P stands for the default alarm level: H for high, M for medium and L for low.
- For each alarm message, corresponding actions are given instructing you to troubleshoot problems. If the problem persists, contact your service personnel.

D.1 Physiological Alarm Messages

D.1.1 Ventilator Parameters

Alarm Messages	P	Cause and action
Paw Too High	H	The airway pressure exceeds the set pressure high alarm limit.
		<ol style="list-style-type: none"> 1. Check the patient. 2. Check the ventilation parameter setup. 3. Check the alarm limits. 4. Check the patient tubing for occlusion.
Paw Too Low	H	Airway pressure setting is lower than the low limit of pressure alarm.
		<ol style="list-style-type: none"> 1. Check the patient. 2. Check the ventilation parameter setup. 3. Check the alarm limits. 4. Check if the patient tubing are leaked or disconnected.
FiO ₂ Too High	H	The inspired O ₂ concentration is greater than the FiO ₂ high alarm limit for at least 30s.
		<ol style="list-style-type: none"> 1. Check air supply. 2. Check the HEPA filter for occlusion. 3. If the ventilator uses the O₂ cell, calibrate the O₂ sensor. If the ventilator uses the paramagnetic O₂ sensor, perform the System Check.
FiO ₂ Too Low	H	The inspired O ₂ concentration has been lower than the FiO ₂ low alarm limit for at least 30 s or is less than 18%.
		<ol style="list-style-type: none"> 1. Check air supply. 2. If the ventilator uses the O₂ cell, calibrate the O₂ sensor. If the ventilator uses the paramagnetic O₂ sensor, perform the System Check.
TVe Too High	M	The TVe monitored value is greater than TVe high alarm limit for continuous 3 mechanical ventilation cycles.
		<ol style="list-style-type: none"> 1. Check the ventilation parameter setup. 2. Check the alarm limits.
TVe Too Low	M	The TVe monitored value is less than TVe low alarm limit for

		continuous 3 mechanical ventilation cycles.
		<ol style="list-style-type: none"> 1. Check the patient. 2. Check the ventilation parameter setup. 3. Check the alarm limits. 4. Check the patient tubing for leakage or occlusion. 5. Perform System Check to test the leakage
MVe Too High	H	<p>MVe is greater than MVe high alarm limit.</p> <ol style="list-style-type: none"> 1. Check the ventilation parameter setup. 2. Check the alarm limits.
MVe Too Low	H	<p>MVe is less than MVe low alarm limit.</p> <ol style="list-style-type: none"> 1. Check the ventilation parameter setup. 2. Check the alarm limits. 3. Check the patient tubing for leakage or occlusion. 4. Perform System Check to test the leakage
Apnea	H	<p>The time of failure to detect respiration exceeds Tapnea.</p> <ol style="list-style-type: none"> 1. Check the patient. 2. Manual breath. 3. Check apnea time setup. 4. Check if the patient tubing are disconnected.
Apnea Vent	H	<p>The time of failure to detect respiration exceeds Tapnea. Start apnea ventilation mode.</p> <p>Check apnea ventilation parameter setup.</p>
ftotal Too High	M	<p>ftotal is greater than ftotal high alarm limit.</p> <ol style="list-style-type: none"> 1. Check the patient. 2. Check the ventilation parameter setup. 3. Check the alarm limits.
ftotal Too Low	M	<p>ftotal is lower than the ftot low alarm limit.</p> <ol style="list-style-type: none"> 1. Check the patient. 2. Check the ventilation parameter setup. 3. Check the alarm limits.
Apnea Ventilation Ended	L	This alarm is given when apnea ventilation ends. There is no need to process this alarm.

D.1.2 CO₂ Module

Alarm Messages	P	Cause and action
EtCO ₂ Too High	M	<p>The monitored parameter value exceeds the alarm limit.</p> <ol style="list-style-type: none"> 1. Check the patient type. 2. Check the alarm limits.
EtCO ₂ Too Low	M	<p>The monitored parameter value exceeds the alarm limit.</p> <ol style="list-style-type: none"> 1. Check the patient type. 2. Check the alarm limits.

Apnea CO ₂	M	The time of failure to detect respiration by the CO ₂ module exceeds Apnea T _{insp} . Whenever the CO ₂ apnea alarm is on, block the [EtCO ₂ Too High] alarm and [EtCO ₂ Too Low] alarm until the alarm is cleared.
		<ol style="list-style-type: none"> 1. Check the patient. 2. Check apnea time setup. 3. Check the connections of CO₂ module sampling device.

D.1.3 SpO₂ Module

Alarm Messages	P	Cause and action
SpO ₂ Too High	M	SpO ₂ value is greater than the high alarm limit.
		<ol style="list-style-type: none"> 1. Check the patient's condition and ventilator settings. 2. Check the patient's inspiratory O₂%. 3. Check the alarm limits.
SpO ₂ Too LOW	M	SpO ₂ value is lower than the low alarm limit.
		<ol style="list-style-type: none"> 1. Check the patient's condition and ventilator settings. 2. Check the patient's inspiratory O₂%. 3. Check the alarm limits.
SpO ₂ Desat	H	SpO ₂ value is lower than the desaturation alarm limit.
		<ol style="list-style-type: none"> 1. Check the patient's condition and ventilator settings 2. Check the patient's inspiratory O₂%. 3. Check the alarm limits.
PR Too High	M	PR value exceeds the high alarm limit.
		<ol style="list-style-type: none"> 1. Check the patient's condition. 2. Check ventilator settings. 3. Check the alarm limits.
PR Too LOW	M	PR value is lower than the low alarm limit.
		<ol style="list-style-type: none"> 1. Check the patient's condition. 2. Check ventilator settings. 3. Check the alarm limits.
No pulse	H	The patient's pulse signal is too weak, and the system cannot perform analysis.
		<ol style="list-style-type: none"> 1. Check the patient's condition. 2. Check SpO₂ sensor and measurement site connection

D.2 Technical Alarm Messages

D.2.1 Power Board

Alarm Messages	P	Cause and action
Battery 1 Failure 02	H	Battery 1 Charge Failure
		Contact your service personnel.
Battery 1 Failure 03	H	Battery 1 Aging
		Contact your service personnel.
Battery 1 Failure 04	H	Battery 1 Comm Error
		Contact your service personnel.
Battery 1 Failure 05	H	Battery 1 Failure
		Contact your service personnel.
Battery 2 Failure 02	H	Battery 2 Charge Failure
		Contact your service personnel.
Battery 2 Failure 03	H	Battery 2 Aging
		Contact your service personnel.
Battery 2 Failure 04	H	Battery 2 Comm Error
		Contact your service personnel.
Battery 2 Failure 05	H	Battery 2 Failure
		Contact your service personnel.
Blower Battery Failure 02	H	Backup air supply battery failed.
		Contact your service personnel.
Blower Battery Failure 03	H	Backup air supply battery failed.
		Contact your service personnel.
Blower Battery Failure 04	H	Backup air supply battery failed.
		Contact your service personnel.
Blower Battery Failure 05	H	Backup air supply battery failed.
		Contact your service personnel.
Battery Temp. High. Connect Ext.Pwr.	M	Battery temperature is a bit high during discharge.
		Connect to the external power supply.
Battery Temp High. Syst maybe Down	H	Battery temperature is too high during discharge. The system may be down.
		Connect to the external power supply.
Battery in Use	L	The current system is powered by battery.
		Connect to the external power supply.
Low Battery. Connect Ext. Power.	M	The remaining battery power is lower than a threshold.
		Connect to the external power supply.
System DOWN. Connect Ext.	H	Battery power is depleted. The system will shut down in a few minutes.

Power.		Connect to the external power supply immediately.
Battery Undetected	H	No battery in main unit or backup air supply at present
		Contact your service personnel.
Fan Failure	M	Power board fan speed abnormal. If it can't be solved, please restart the machine.
		Contact your service personnel.
Device Failure 03	H	Power Board Selftest Error.
		Contact your service personnel.

D.2.2 Main Control Board

Alarm Messages	P	Cause and action
Please Reset Date and Time	L	Button cell is available in the system. But the clock is powered down and reset.
		Re-set the date and time.
Key Error	L	Hardkey or rotary encoder is depressed continuously for more than 35s.
		Contact your service personnel.
Device Failure 04	H	Ctrl Module Init Error.
		Contact your service personnel.
Device Failure 05	H	Ctrl Module Comm Stop.
		Contact your service personnel.
Device Failure 19	H	Power Board Comm Stop.
		Contact your service personnel.
Device Failure 20	H	SpO ₂ Module Comm Stop.
		Restart the ventilator or contact your service personnel.
Device Failure 22	H	Protecting Module Comm Stop.
		Contact your service personnel.

D.2.3 Monitor Board

Alarm Messages	P	Cause and action
Technical Error 04	L	Buzzer Failure.
		Contact your service personnel.
Technical Error 05	M	Atmospheric Pressure Sensor Failure.
		Contact your service personnel.
Technical Error 07	M	3-way Valve Failure.
		Contact your service personnel.
Technical Error 08	M	Nebulizer Valve Failure.
		Contact your service personnel.
Technical Error 09	M	Insp. Temp Sensor Failure.
		Contact your service personnel.

Technical Error 10	L	Heating function of the expiration valve is faulty.
		Contact your service personnel.
Device Failure 01	H	Power Supply Voltage Error.
		Contact your service personnel.
Device Failure 02	H	Memory Error.
		Contact your service personnel.
Device Failure 05	H	Ctrl Module Comm Stop.
		Contact your service personnel.
Device Failure 06	H	Ctrl Module Selftest Error.
		Contact your service personnel.
Device Failure 09	H	Pressure Sensor Failure.
		Contact your service personnel.
Device Failure 10	H	Safety Valve Failure.
		Contact your service personnel.
Device Failure 12	H	Air Insp. Limb Failure.
		Contact your service personnel.
Device Failure 13	H	O ₂ Limb Failure.
		Contact your service personnel.
Device Failure 21	H	Pressure Sensor Zero Point Error.
		Contact your service personnel.
Device Failure 22	H	Protecting Module Comm Stop.
		Contact your service personnel.
Device Failure 23	H	Protection Module Self Check Error.
		Contact your service personnel.
PEEP Too High	H	Monitored PEEP exceeds PEEP + 5 cmH ₂ O (PEEP + 10 cmH ₂ O for APRV mode) within any fully mechanical ventilation cycle.
		<ol style="list-style-type: none"> 1. Check the ventilation parameter setup. 2. Check the patient tubing for occlusion.
PEEP Too Low	M	Patient's PEEP is less than the setting value to a certain extent.
		<ol style="list-style-type: none"> 1. Check the patient tubing for leakage. 2. Perform System Check to test the leakage
Airway Obstructed?	H	Tube is occluded.
		<ol style="list-style-type: none"> 1. Check and clean the patient tubing. 2. Check and clean the expiration valve.
Insp. Limb Airway Obstructed?	M	The patient tubing is bent or occluded in case of O ₂ therapy.
		Check if the patient tubing is occluded or bent. If yes, clear it.
Sustained Airway Pressure	H	The airway pressure measured by any pressure sensor is greater than the setting PEEP + 15 cmH ₂ O for 15 s consecutively.
		<ol style="list-style-type: none"> 1. Check the patient. 2. Check the ventilation parameter setup. 3. Check the patient tubing for occlusion.
Airway Leak?	L	Tube is leaky.

		<ol style="list-style-type: none"> 1. Check the patient tubing for leakage. 2. Perform System Check to test the leakage
Tube Disconnected?	H	Tube is disconnected.
		Re-connect the patient tubing.
Pressure Limited	L	In volume mode or pressure mode when ATRC function is enabled, the pressure reaches Paw high alarm limit-5.
		<ol style="list-style-type: none"> 1. Check the patient. 2. Check the ventilation parameter setup. 3. Check pressure high alarm limit.
Volume Limited	L	In pressure mode, delivered gas volume exceeds the set TV high limit.
		<ol style="list-style-type: none"> 1. Check the patient. 2. Check the ventilation parameter setup. 3. Check the alarm limits.
Pinsp Not Achieved	L	Pinsp is lower than the pressure setting value by 3 cmH ₂ O or 2/3 of the pressure setting value, whichever is less.
		<ol style="list-style-type: none"> 1. Check the patient. 2. Check TV alarm limits. 3. Check the O₂ supply. 4. Check the patient tubing for leakage. 5. Check the HEPA filter for occlusion.
TV Not Achieved	L	TVi is less than the TV setting value by more than 10 mL + 10 % of the setting value.
		<ol style="list-style-type: none"> 1. Check the patient. 2. Check pressure high alarm limit. 3. Check the high-pressure gas supply or the HEPA filter for occlusion. 4. Check the O₂ supply. 5. Check the patient tubing for leakage or occlusion.
Pressure Limited in Sigh cycle	L	The pressure reaches Paw high alarm limit-5 in sigh cycle.
		<ol style="list-style-type: none"> 1. Check the patient. 2. Check pressure high alarm limit. 3. Check the patient tubing for occlusion. 4. Consider to turn off sigh.
O ₂ Supply Failure	H	Oxygen supply is not sufficient to support normal ventilator operation.
		<ol style="list-style-type: none"> 1. Check connection with O₂ supply. 2. Check O₂ supply pressure.
Air Supply Failure	H	Air supply is not sufficient to support normal ventilator operation.
		<ol style="list-style-type: none"> 1. Check connection with Air supply. 2. Check air supply pressure
No Gas Supply Pressure	H	Both oxygen and air supply are not sufficient to support normal ventilator operation.
		<ol style="list-style-type: none"> 1. Check connection with air and O₂ supply. 2. Check air and O₂ supply pressure. 3. For machines with backup air supply configuration, check whether

		the Blower Disabled switch for user maintenance is on. 4. Check backup air supply for failure.
Tinsp Too Long	L	In PSV mode, Tinsp exceeds 4s for adult, 1.5s for pediatric, and the maximum inspiration time set by the user for neonates for continuous 3 cycles.
		1. Check the patient. 2. Check the ventilation parameter setup. 3. Check the patient tubing for leakage.
Please Check Exp. Flow Sensor	H	Installing the expiratory flow sensor fails.
		Contact your service personnel.
Insp. Gas Temp Too High	H	The gas temperature exceeds 55°C.
		1. Disconnect the patient. 2. Restart the machine. Contact the specified service personnel if the issue persists.
Flow Sensor Type Error	H	Installation error with air flow sensor or O ₂ flow sensor.
		Contact your service personnel.
Blower Fan Failure	M	Backup air supply fan speed error. If it can't be solved, restart the machine.
		Please contact your service personnel (turning off backup air supply could also resolve the alarm).
Blower Temperature High	H	Backup air supply temperature exceeds the threshold.
		1. Check if the operating ambient temperature of the machine exceeds the maximum operating temperature specified by the vendor. 2. Check if the fan inlet and outlet are occluded. If yes, clear the foreign substance and dust. 3. Check the rotation of the fan. If it runs abnormally (such as abnormal sound or rotation speed), replace the fan.
AMV: Cannot Meet Target	L	Cannot meet established MV%
		1. Check the ventilation parameter setup. 2. Check the alarm limits setting.
Technical Error. Only Blower Gas Supply Available.	H	Three-way valve failure, only blower gas supply available.
		Contact your service personnel.
Blower Failure 3-way Valve Failure	H	Three-way valve failure, blower module disabled.
		Contact the specified service personnel.
Replace HEPA Filter	L	HEPA filter occluded, resistance increased.
		Contact the specified service personnel.
Blower Technical Error 01	M	Backup air supply Temp Sensor Failure.
		Contact your service personnel.
Blower Technical Error 02	M	HEPA Pressure Sensor Failure.
		Contact your service personnel.
Blower Technical	M	Backup air supply three-way valve microswitch failure.

Error 03		Contact your service personnel.
Blower Failure 01	H	Insp. Limb valve or flow sensor fails.
		1. Use another device for ventilation.
		2.Restart the machine. 3. Contact the specified service personnel if the issue persists.
Blower Failure 02	H	Insp. Valve Disconnected.
		Contact your service personnel.
Blower Failure 03	H	Backup air supply Temp Too High.
		Contact your service personnel.
Blower Failure 04	H	Backup air supply Failure.
		Contact your service personnel.
O ₂ Sensor Unconnected	L	The O ₂ sensor is not connected.
		Connect the O ₂ sensor.
Please Replace O ₂ Sensor.	M	The chemical O ₂ sensor is expired.
		Please replace the O ₂ sensor.
Please calibrate O ₂ sensor	L	Please calibrate the O ₂ sensor.
		Please calibrate O ₂ concentration.
Please reset O ₂ sensor	M	The oxygen concentration measured by the paramagnetic oxygen sensor has a large error.
		Contact your service personnel.
Please perform pressure calibration.	H	Calibrate the pressure sensor.
		Contact your service personnel.
Please perform flow calibration.	H	Calibrate the flow sensor.
		Please perform flow calibration.

D.2.4 CO₂ Module

Alarm Messages	P	Cause and action
CO ₂ Module Failure 01	M	Sidestream CO ₂ module zeroing fails. The gain input signal offset is too large, exceeding the adjustable range.
		Contact your service personnel.
CO ₂ Module Failure 02	M	CO ₂ Init Error. An error occurs to the CO ₂ module during initialization.
		Contact your service personnel.
CO ₂ Module Failure 03	M	CO ₂ self check error. An error occurred in the CO ₂ module during self check.
		Contact your service personnel.
CO ₂ Module Failure 04	M	CO ₂ Hardware Error.
		Contact your service personnel.
CO ₂ Module Failure 05	M	CO ₂ Comm Stop, CO ₂ Module Failure, CO ₂ Comm Error or communication failure reaches 10s.
		Contact your service personnel.

CO ₂ Module Failure 06	M	Mainstream CO ₂ module zeroing fails.
		Contact your service personnel.
CO ₂ Sensor High Temp	L	The sensor temperature is too high (above 63 °C).
		Contact your service personnel.
CO ₂ Sampleline Occluded	L	Sampling line is faulty or occluded.
		1. Check the sampling line for occlusion. 2. Replace the sampling line. 3. Replace the water trap.
CO ₂ No Watertrap	L	The water trap is disconnected or not connected properly. Check the water trap.
		Re-install the water trap.
Et CO ₂ Overrange	L	Parameter measured values exceed the measurement range (error range is included).
		1. Perform CO ₂ module zeroing. 2. Contact your service personnel.
Please Replace CO ₂ Sensor	M	The mainstream CO ₂ module sensor is faulty.
		Contact your service personnel.
CO ₂ No Sensor	L	The mainstream CO ₂ module sensor is not connected.
		Connect the CO ₂ sensor.

D.2.5 SpO₂ Module

Alarm Messages	P	Cause and action
SpO ₂ Sensor Off	L	Connected SpO ₂ sensor became disconnected from patient tubing (e.g. wire disconnection or short circuit).
		Check SpO ₂ sensor and measurement site connection.
Please Replace SpO ₂ Sensor	M	SpO ₂ sensor failed (e.g. wire disconnection or short circuit).
		1. Replace SpO ₂ sensor. 2. Contact your service personnel.
SpO ₂ No Sensor	L	Main cable has disconnected from module. Connection between sensor and main cable has disconnected.
		Check that SpO ₂ cable is connected to the module.
SpO ₂ Too Much Light	L	The light to which the sensor is exposed is so bright that the sensor's photodetector is absorbing the surrounding light.
		Put SpO ₂ sensor in a place with lower ambient light levels.
SpO ₂ No Pulse	L	SpO ₂ sensor cannot obtain pulse signal (or incomplete signal).
		1. Check the patient's condition. 2. Check SpO ₂ sensor and measurement site connection 3. Replace SpO ₂ sensor.
SpO ₂ Module Error	M	SpO ₂ module error\SpO ₂ initialization error
		1. Replace SpO ₂ sensor. 2. Contact your service personnel.
SpO ₂ Overrange	L	Measured values of parameter SpO ₂ exceed the measurement range.

		<ol style="list-style-type: none"> 1. Replace SpO₂ sensor. 2. Contact your service personnel.
PR Overrange	L	<p>Measured values of parameter PR exceed the measurement range.</p> <ol style="list-style-type: none"> 1. Replace SpO₂ sensor. 2. Contact your service personnel.

D.2.6 Neo. Module

Alarm Messages	P	Cause and action
Reverse the neonatal flow sensor.	M	<p>Neonatal flow sensor connected reversed.</p> <p>Please reverse the neonatal flow sensor.</p>
Neo. Flow Sensor Overrange	M	<p>Range of neonatal flow sensor exceeds 32 L/min.</p> <ol style="list-style-type: none"> 1. Check the patient's condition and ventilator settings 2. Change patient type if necessary.
Neo. Flow Sensor Failure	L	<p>Neonatal flow sensor failure.</p> <ol style="list-style-type: none"> 1. Replace neonatal flow sensor 2. Contact your service personnel.
No Neo. Flow Sensor	M	<p>Serial cable of neonatal flow sensor is not connected. Sampling line of neonatal flow sensor is not connected.</p> <p>Check the connection of the neonatal flow sensor cable and sampling line.</p>
Wrong Neo. Flow Sensor Type	L	<p>Adult proximal flow sensor is used.</p> <p>Use neonatal flow sensor.</p>
Neo. Flow Sensor Monitoring Off	M	<p>Neonatal flow sensor monitor off in the volume mode.</p> <p>Neonatal flow sensor monitor on.</p>

D.2.7 Auxiliary Pressure

Alarm Messages	P	Cause and action
Please calibrate auxiliary pressure sensor	H	<p>Please calibrate auxiliary pressure sensor.</p> <p>Contact your service personnel.</p>
Paux1 Pressure Sensor Failure	H	<p>The sensor is detected when the ventilator is powered on, but is not detected in the process of use.</p> <p>Contact your service personnel.</p>
Paux2 Pressure Sensor Failure	H	<p>The sensor is detected when the ventilator is powered on, but is not detected in the process of use.</p> <p>Contact your service personnel.</p>

FOR YOUR NOTES

E Factory Defaults

This chapter lists the most important factory default settings which are not user-adjustable. When necessary, you can restore the factory default settings.

E.1 Ventilation Parameters

Ventilation mode parameter settings	Factory default setting
TV	Adult: 500 mL; pediatric: 100 mL; neonate: 20 mL
Inspiratory Flow	Adult: 20 L/min; pediatric: 7 L/min; neonate: 2.5 L/min
Tpause(%)	OFF
MV%	100%
O ₂ %	Non-CPRV: 40 vol.%; CPRV: 100 vol.%
f	Adult: 12/min (CPRV: 10/min); pediatric: 20/min; neonate: 35/min
fsimv	Adult: 5/min; pediatric: 15/min; neonate: 30/min
T _{insp}	Adult: 1.70 s; pediatric: 1.00 s; neonate: 0.57 s
I:E	1:2
T _{i max}	Adult: 1.70 s; pediatric: 1.00 s; neonate: 0.57 s
T _{slope}	0.20 s
PEEP	Non CPRV: 3 cmH ₂ O; CPRV: 0 cmH ₂ O
ΔP _{insp}	15 cmH ₂ O
ΔP _{supp}	In PSV and PSV-S/T mode: 15 cmH ₂ O; in other modes: 0 cmH ₂ O
Phigh	15 cmH ₂ O
Plow	3 cmH ₂ O
Thigh	Adult: 1.70 s; pediatric: 1.00 s; neonate: 0.57 s
Tlow	Adult: 3.3 s; pediatric: 2.0 s; neonate: 1.3 s
Assist	Non-CPRV: ON; CPRV: OFF
F-trig	Adult: 2.0 L/min; pediatric: 1.0 L/min; neonate: 0.5 L/min
P-Trig	/
Exp%	Auto
Apnea Vent	ON
ΔP _{apnea}	15 cmH ₂ O

TVapnea	Adult: 500 mL; pediatric: 100 mL; neonate:20 mL
fapnea	Adult: 12/min; pediatric: 20/min; neonate: 35/min
Apnea Tinsp	Adult: 1.70 s; pediatric: 1.00 s; neonate: 0.57 s
$\Delta P_{manInsp}$	15 cmH ₂ O
TmanInsp	Neonate: 0.57 s
Tube type	Switch off ATRC function
Tube I.D.	Adult: 8.0 mm; pediatric: 5.0 mm; neonate: 3.5 mm
Compensate	80%
Expiration	ON
Sigh	OFF
$\Delta int.PEEP$	OFF
Interval	1 min
Cycles Sigh	3
e-ITD	ON
Neg.Plimit	-15 cmH ₂ O

E.2 Setup

Setup	Factory default value
Menu-Calibration-CO ₂ In Maintenance-CO ₂ %	3%
Menu-Setup-O ₂ Cell	ON
Menu - Setup - Neo. Module	ON
Menu-Setup - Ventilation-Inspiratory Flow/Tpause (%)	Inspiratory flow
Menu - Setup - Ventilation - Tinsp/I:E	Tinsp
Menu- Setup- Ventilation- IBW/Height	Height
Menu- Setup- Ventilation - TV/IBW	7 mL/kg
Menu- Setup - Ventilation- DuoLevel Setup	Thigh
Menu-Setup- Ventilation-Invasive Apnea mode	Pressure Control
Menu - Setup - Ventilation - Increase O ₂ % during O ₂ ↑	Adult: 60%; pediatric: 60%; neonate: 10%
Menu - Screen - Brightness/Volume - Day & Night Mode	Day Mode
Menu - Screen - Brightness/Volume - Key Volume	2
Menu - Screen - Brightness/Volume - Screen Brightness	5
Menu-Screen-Screen Setup-Waveform	3
Setup-Screen-Screen Setup-Draw Wave	Curve

Menu -Screen - Screen Setup - Layout Setup Switch	ON
Time-date	2012.01.01
Time-time	00:00:00
Time-Date Format	YYYY-MM-DD
Time-Time Format	24 h

E.3 SystemSettings

System	Factory default value
Menu - System - Language/Unit - Language	Chinese
Menu - System - Language/Unit - Weight Unit	kg
Menu - System - Language/Unit - Height Unit	cm
Menu - System -Language/Unit - Pressure Unit	cmH ₂ O
Menu - System - Language/Unit - CO ₂ Unit	mmHg
Menu - System - Interface - Nurse Call - Switch	OFF
Menu - System - Interface - Nurse Call - Signal Type	Continuous
Menu - System - Interface - Nurse call - Trigger Type	Normally Closed
Menu - System - Interface - Nurse Call - Alarm Type	Physiological alarm, technical alarm
Menu - System - Interface - Nurse Call - Alarm Level	High, Med

E.4 Alarms

Alarms	Factory default setting
Alarms – Vent Limits - Paw High Limit	50 cmH ₂ O (in CPAP mode: 60 cmH ₂ O)
Alarms - Vent Limits - Paw Low Limit	OFF
Alarms - Vent Limits - Minute Volume High Alarm Limit	Adult: 9.0 L/min; pediatric: 3.0 L/min; neonate: 1.05 L/min
Alarms - Vent Limits - Minute Volume Low Alarm Limit	Adult: 3.6 L/min; pediatric: 1.2 L/min; neonate: 0.42 L/min
Alarms - Vent Limits - TVe High Alarm Limit	Adult: 1000 mL; pediatric: 200 mL; neonate: 40 mL
Alarms - Vent Limits - TVe Low Alarm Limit	Adult: 250 mL; pediatric: 50 mL; neonate: 10 mL
Alarms - Vent Limits - ftot High Alarm	OFF

Limit	
Alarms - Vent Limits - ftot Low Alarm Limit	OFF
Alarms - Module Limits - FiO ₂ High Alarm Limit	100 vol.%
Alarms - Module Limits - FiO ₂ Low Alarm Limit	21 vol.%
Alarms - Module Limits - EtCO ₂ High Alarm Limit	Adult: 50 mmHg; pediatric: 45 mmHg
Alarms - Module Limits - EtCO ₂ Low Alarm Limit	Adult: 15 mmHg; pediatric: 20 mmHg; neonate: 30mmHg
Alarms - Module Limits - Desat	80%
Alarms - Module Limits - SpO ₂ High Alarm Limit	100%
Alarms - Module Limits - SpO ₂ Low Alarm Limit	90%
Alarms - Module Limits - PR High Alarm Limit	Adult: 120 l/min; pediatric: 160 l/min; neonate: 200 l/min
Alarms - Module Limits - PR Low Alarm Limit	Adult: 50 l/min; pediatric: 75 l/min; neonate: 100 l/min
Alarms - Vent Limits - Tapnea	In non-nCPAP mode: Adult & pediatric: 15 s; neonate: 10 s In nCPAP mode: OFF
Alarms - Audio - Alarm Volume	5

E.5 History

History	Factory default setting
Graphic-Display Group	All
Graphic-Zoom	10 min
Tabular-Display Group	All
Tabular-Interval	1 min
Event Logbook-Filter	All Events

E.6 Special Functions

Special Functions	Factory default setting
Nebulizer - Time	30 min
Tools - Advanced - P-V Tools - Pstart	3 cmH ₂ O
Tools - Advanced - P-V Tools - Pmax	15 cmH ₂ O
Tools - Advanced - P-V Tools - Flow	6 L/min
Tools - Advanced - P-V Tools - Vlimit	770 mL
Tools - Advanced - P-V Tools - Ref. Loop	Hide

Tools - Advanced - SI - Pressure Hold	Adult: 35 cmH ₂ O; pediatric: 20 cmH ₂ O
Tools - Advanced - SI - Hold Time	Adult: 30 s; pediatric: 15 s
Tools - Advanced - Weaning - SBT - PEEP	5 cmH ₂ O
Tools - Advanced - Weaning - SBT - ΔP _{supp}	5 cmH ₂ O
Tools - Advanced - Weaning - SBT - FiO ₂	40%
Tools - Advanced - Weaning - SBT - Duration	30 min
Tools - Advanced - Weaning - SBT - Ttolerance	180 s
Tools - Advanced- Weaning-Criteria-fspn upper Limit	35 /min
Tools - Advanced- Weaning-Criteria-fspn lower Limit	OFF
Tools - Advanced - Weaning - Criteria - TVe/IBW upper limit	15 mL/kg
Tools - Advanced - Weaning - Criteria - TVe/IBW lower limit	4 mL/kg
Tools - Advanced - Weaning - Criteria - RSBI upper limit	105 L/(min*L)
Tools - Advanced - Weaning - Criteria - EtCO ₂ upper limit	Adult: 50 mmHg; pediatric: 50 mmHg; neonate: 45mmHg
Tools - Advanced - Weaning - Criteria - EtCO ₂ lower limit	Adult: 15 mmHg; pediatric: 20 mmHg; neonate: 30mmHg
Tools - Advanced - Weaning - Criteria - SpO ₂ upper limit	100%
Tools - Advanced - Weaning - Criteria - SpO ₂ lower limit	90%
Tools - Advanced - Weaning - Criteria - PR upper limit	120 /min
Tools - Advanced - Weaning - Criteria - PR lower limit	50 /min

E.7 O₂ Therapy

O ₂ Therapy	Factory default setting
O ₂ Therapy - O ₂ %	40 vol.%
O ₂ Therapy - Flow	Adult: 25 L/min; pediatric: 8 L/min; neonate: 4 L/min
O ₂ therapy - O ₂ Duration	0 min

E.8 CO₂ Module

CO ₂ Module	Factory default setting
Menu - Setup - CO ₂ Module - Monitoring	ON
Menu - Setup - CO ₂ Module - BTPS Comp	OFF

E.9 SpO₂ Module

SpO ₂ Module	Factory default setting
Menu - Setup - SpO ₂ Module - Monitoring	ON
Menu - Setup - SpO ₂ Module - Sensitivity	Med
Menu - Setup - SpO ₂ Module - Sweep Speed	25 mm/s
Menu - Setup - SpO ₂ Module - Beat Volume	1

E.10 Other

Patient	Factory default setting
Weight	Adult: 70 kg; pediatric: 15.4 kg; neonate: 3 kg
Gender	Male
Height	Adult: 174 cm; pediatric: 100cm
Ventilation Type	Invasive

F Symbols and Abbreviations

F.1 Unit

A	ampere
Ah	ampere hour
bpm	Breaths per minute
°C	centigrade
cc	cubic centimetre
cm	centimeter
cmH ₂ O	centimeter of water
dB	decibel
°F	fahrenheit
g	gram
hr	hour
Hz	hertz
hPa	hectopascal
inch	inch
k	kilo-
kg	kilogram
kPa	kilopascal
L	litre
lb	pound
m	meter
mAh	milliampere hour
mbar	millibar
mg	milligram
min	minute
ml	milliliter
mm	millimeter
mmHg	millimeter of mercury
ms	millisecond
mV	millivolt
mW	milliwatt
nm	nanometer
ppm	part per million
s	second
V	volt
VA	volt ampere

Ω	ohm
μA	microampere
μV	microvolt
W	watt

F.2 Symbols

-	minus
%	percent
/	per; divide; or
~	to
^	power
+	plus
=	equal to
<	less than
>	greater than
\leq	less than or equal to
\geq	greater than or equal to
\pm	plus or minus
\times	multiply
©	copyright

F.3 Abbreviations

AMV	Adaptive Minute Ventilation
Apnea T _{insp}	Inspiratory time of Apnea Ventilation
Apnea Vent	Apnea Ventilation
APRV	Airway Pressure Release Ventilation
ATPD	Ambient Temperature and Pressure Dry
BTPS	Body Temperature and Pressure Saturated
C _{20/C}	Ratio of the compliance during the last 20% of inspiration to the total compliance.
C _{dyn}	Dynamic Compliance
CPAP/PSV	Continuous Positive Airway Pressure/ Pressure Support Ventilation
CPRV	Cardiopulmonary Resuscitation Ventilation
C _{stat}	Static Compliance
Cycles Sigh	Cycles Sigh
DuoLevel	Duo Level Ventilation

EEF	End Expiratory Flow
Et CO ₂	End-tidal Carbon Dioxide
Exp%	Percent of Expiration Trigger
Fi CO ₂	Fraction of Inspired Carbon Dioxide
FiO ₂	Inspired Oxygen Concentration
Flow	Flow
f	Breathing Frequency
fapnea	Frequency of Apnea Ventilation
fmand	Mandatory Frequency
fspn	Spontaneous Frequency
fsimv	Frequency of SIMV
Ftotal	Total Breathing Frequency
F-Trigger	Flow Trigger
I:E	Inspiratory Time:Expiratory Time Ratio
Interval	Interval
MV	Minute Volume
MV%	Percentage of Minute Volume
MVspn	Spontaneous Minute Volume
MVleak	Leakage Minute Volume
nCPAP	Nasal Continuous Positive Airway Pressure ventilation
NIF	Negative Inspiratory Force
NIV	Non-Invasive Ventilation
O ₂	Oxygen
P0.1	100ms Occlusion Pressure
P-A/C	Pressure - Assist/Control Ventilation
Paw	Airway Pressure
PEEP	Positive End-Expiratory Pressure
PEEPi	Intrinsic PEEP
PEEPtot	Total Positive End-Expiratory Pressure
PEF	Peak Expiratory Flow
Phigh	Pressure High
PIF	Peak Inspiratory Flow
△P _{insp}	Pressure Control Level of Inspiration (relative to PEEP/P _{low})
P _{limit}	Pressure Limit Level
P _{low}	Pressure Low
△P _{manInsp}	Pressure Control Level of Manual Inspiration (relative to PEEP/P _{low})

Pmean	Mean Pressure
Ppeak	Peak Pressure
Pplat	Plateau Pressure
PRVC	Pressure Regulated Volume Control Ventilation
PRVC-SIMV	Pressure Regulated Volume Control Ventilation- Synchronized Intermittent Mandatory Ventilation
PSV-S/T	Pressure Support Ventilation-Spontaneous/Timed
P-SIMV	Pressure – Synchronized Intermittent Mandatory Ventilation
P-Trigger	Pressure Trigger
Δ int.PEEP	Intermittent Positive End-Expiratory Pressure
Δ Papnea	Pressure of Apnea Ventilation (relative to PEEP/Plow)
Δ Psupp	Pressure Support Level(relative to PEEP/Plow)
Rinsp	Inspiration Resistance
Rexp	Expiration Resistance
Sigh	Sigh
SIMV	Synchronized Intermittent Mandatory Ventilation
TmanInsp	Time of Manual Inspiration
Texp	Time of Expiration
Thigh	Time of High Pressure
Tinsp	Time of Inspiration
Tlow	Time of Low Pressure
Tpause(%)	Percent of Inspiratory Pause Time
Tplat	Time of Plat In Inspiratory Period
Tslope	Time of Pressure Rising
TV	Tidal Volume
TVapnea	Tidal Volume of Apnea Ventilation
TVe	Expired Tidal Volume
TVe/IBW	Expired Tidal Volume Per Ideal Body Weight
TVe spn	Spontaneous Expired Tidal Volume
TVi	Inspired tidal Volume
Volume	Gas Volume
Vtrap	Volume of Trap Gas

V-A/C	Volume - Assist/Control Ventilation
V-SIMV	Volume - Synchronized Intermittent Mandatory Ventilation
VS	Volume Support Ventilation
RCexp	Expiratory time constant
RSBI	Rapid Shallow Breath Index
WOBimp	Imposed Work of Breath
WOBpat	Patient Work of Breathing
WOBtot	Total Work of Breathing
WOBvent	Ventilator Work of Breathing

FOR YOUR NOTES

