











































# ePM Series Patient Monitor Quick Reference Guide

(Applicable for ePM 10/ePM 10A/ePM 10C/ePM 12/ePM 12A/ePM 12C/ePM 15/ePM 15A/ePM 15C)

Symbol	Function
 Main Menu	Enters the main menu.
 Alarm Setup	Enters the <b>Alarm</b> menu.
 Audio Pause	Pauses alarm tone.
 Review	Enters the <b>Review</b> menu.
 Patient Demographics	Enters the <b>Patient Management</b> menu.
 NIBP Start/Stop	Starts an NIBP measurement or stops the current NIBP measurement.
 NIBP STAT	Starts a five-minutes continuous NIBP measurement.
 Zero IBP	Starts IBP zero calibration.
 Venipuncture	Opens the Venipuncture window.
 Parameters Setup	Enters the <b>Parameters Setup</b> menu.

Symbol	Function
 More	Shows more quick keys.
 Alarm Reset	Acknowledges ongoing alarms and reset the alarm system.
 Alarm Pause	Pauses the current alarms.
 Standby	Enters the Standby mode.
 Screen Setup	Enters the <b>Screen Setup</b> menu.
 Stop All	Stops all NIBP measurements.
 NIBP Measure	Enters the <b>NIBP Measure</b> menu.
 PAWP	Enters the <b>PAWP</b> screen.
 C.O. Measure	Opens the <b>C.O. Measure</b> window.
 Remote View	Opens the <b>Remote View</b> window.

Symbol	Function
 Manual Event	Manually triggers and saves an event.
 OxyCRG	Opens the <b>OxyCRG</b> window.
 Privacy Mode	Enters the privacy mode.
 End Case Report	Prints the selected end case reports.
 Volume	Enters the <b>Volume</b> menu.
 Calculations	Enters the <b>Calculations</b> menu.
 Print	Starts printing a real-time report.
 Unit	Enters the <b>Unit</b> menu.
 Lead/Gain	Enters the <b>ECG Lead/Gain</b> menu.
 EWS	Enters the <b>EWS</b> screen.
 Discharge Patient	Enters the <b>Discharge Patient</b> dialog box.

Symbol	Function
 Minitrends	Enters the Minitrends screen.
 ECG Full-Screen	Enters the 12-lead ECG full screen.
 Night Mode	Enters the night mode.
 Intubation Mode	Enters the intubation mode.
 Freeze	Freezes waveforms.
 Load Config	Enters the <b>Load Config</b> menu.
 Record	Starts/Stops a recording.
 Call Help	Calls for help.
 ECG 24h Sum	Views the 24-hour ECG summary.
 GCS	Enters the <b>GCS</b> menu.
 Discharged Patients	Enters the <b>Discharged Patients</b> dialog box.

## Turning on the Monitor

Press the power switch to turn on the monitor.

## Quick Operation with Gestures

Using the following gestures can take a quick operation.

- With two fingers:
  - ◆ For adult and pediatric patients, swiping left or right from the minitrends screen can change screens among the normal screen, the big numeric screen and the minitrends screen.
  - ◆ For adult and pediatric patients, swiping left or right from the EWS screen can change screens among the normal screen, the big numeric screen and the EWS screen.
  - ◆ For neonatal patients, swiping left or right on the touchscreen can change screens among the SpO<sub>2</sub> screen, the OxyCRG screen and the big numeric screen.
  - ◆ Swiping down the touchscreen can enter the **Discharged Patients** dialog box.
- With a single finger:
  - ◆ Swiping right on the touchscreen can show or expand the minitrends screen.
  - ◆ Swiping left on the touchscreen can hide or contract the minitrends screen.
  - ◆ Swiping down on the touchscreen can set the wireless network connection.

## Display

### Locking the Touchscreen

To lock the touchscreen, hold and press the **Main Menu** quick key and slide as directed by the arrow. A padlock symbol  displays at the top of the main menu quick key if the touchscreen is disabled.

### Unlocking the Touchscreen

The touchscreen is enabled in the following situations:

- The preset time is reached.
- Hold and press the **Main Menu** quick key and slide as directed by the arrow.

### Choosing a Screen

1. Access **Choose Screen** by either of the following ways:
  - ◆ Select the **Screen Setup** quick key.
  - ◆ Select the **Main Menu** quick key → from the **Display** column select **Choose Screen**.
2. Select the desired screen.

You can also quickly choose a screen with two fingers.

- For adult and pediatric patients:
  - ◆ From the minitrends screen, swiping left or right on the touchscreen can change screens among the normal screen, the big numeric screen and the minitrends screen.
  - ◆ From the EWS screen, swiping left or right on the touchscreen can change screens among the normal screen, the big numeric screen and the EWS screen.
- For neonatal patients, swiping left or right on the touchscreen can change screens among the SpO2 screen, the OxyCRG screen and the big numeric screen..

## Displaying Parameter Numerics and Waveforms

1. Access **Tile Layout** by either of the following ways:
  - ◆ Select the **Screen Setup** quick key → select the **Tile Layout** tab.
  - ◆ Select the **Main Menu** quick key → from the **Display** column select **Tile Layout**.
2. Select a parameter numeric area or waveform area, and then from the popup list select an element you want to display in this area. The parameters and waveforms you do not select will not be displayed.

## Setting the Quick Key

1. Set the quick key by either of the following ways:
  - ◆ Select the **Screen Setup** quick key → select the **Select Quick Keys** tab.
  - ◆ Select the **Main Menu** quick key → from the **Display** column select **Quick Keys**.
2. Select the **Current** tab to configure the quick keys you want to display on the screen: From the top of this page, select a block where you want to show a certain quick key, and then select the quick key from the quick key list.
3. Select the **More** tab to configure the quick keys you want to display when the More quick key is selected.

## Configuring the Monitor

### Adjusting the Volume

Select the **Volume** quick key to set **Alarm Volume**, **QRS Volume**, and **Key Volume**.

### Adjusting the Screen Brightness

1. Access **Display** by either of the following ways:
  - ◆ Select the **Screen Setup** quick key → select the **Display** tab.
  - ◆ Select the **Main Menu** quick key → from the **Display** column select **Display**.
2. Set **Brightness** for the display. If **Brightness** is set to **Auto**, screen brightness automatically changes with ambient light level.

## Patient Management

### Admitting a Patient

The monitor admits a new patient in the following situations:

- After a patient is manually discharged, the monitor automatically admit a new patient.
- After being switched off for the selected time period, the monitor automatically discharge the previous patient and admit a new patient at startup.
- If the monitor has not detected certain patient vital signs (ECG, SpO<sub>2</sub>, PR, RR, NIBP) for 30 minutes, you will be prompted whether to start monitoring a new patient if any of the above vital signs are detected again.

### Editing Patient Information

1. Select the **Patient Demographics** quick key.
2. In the **Patient Management** menu, edit patient information as required.

If you connect a barcode reader with your monitor, you can scan the patient's barcode to enter the patient's medical number.

### Discharging a Patient

Manually discharge a patient by any of the following ways:

- Swipe down the touchscreen with two fingers.
- Select the **Discharge Patient** quick key.
- Select the patient information area at the top left corner of the screen → **Discharge Patient**.
- Select the **Patient Demographics** quick key → select **Discharge Patient**.
- Select the **Main Menu** quick key → from the **Patient Management** column select **Discharge**.

### Entering Night Mode

1. Select the **Night Mode** quick key, or select the **Main Menu** quick key → from the **Display** column select **Night Mode**.
2. Change the night mode settings if necessary.
3. Select **Enter Night Mode**.

### Entering Privacy Mode

Choose any of the following ways to enter the privacy mode:

- Select the **Privacy Mode** quick key → select **Ok**.
- Select the **Main Menu** quick key → from the **Display** column select **Privacy Mode** → select **Ok**.





## Viewing Other Beds

To view other beds, enter the **Remote View** window by any of the following ways:

- Select the **Remote View** quick key.
- Select the **Screen Setup** quick key → select the **Primary Display** tab or **Secondary Display** tab → select the **Choose Screen** tab → select **Remote View**.
- Select the bed at the alarm watch tile, if configured, on the main screen.

## Alarms

### Alarm Status Symbols

Symbol	Description	Symbol	Description
	All the alarms are paused.		Audible alarm tones are paused.
	Audible alarm tones are turned off.		Alarms are acknowledged and the alarm system is reset.
	Individual physiological alarms are turned off or the system is in the alarm off status.		

### Setting Parameter Alarm Properties

1. Access the **Limits** page by either of the following ways:
  - ◆ Select the **Alarm** quick key.
  - ◆ Select the **Main Menu** quick key → from the **Alarm** column select **Limits**.
2. Select a parameter tab and set alarm switch, limits, priority, etc.

### Initiating Auto Alarm Limits

1. Access the **Limits** page by either of the following ways:
  - ◆ Select the **Alarm** quick key → select the **Limits** tab.
  - ◆ Select the **Main Menu** quick key → from the **Alarm** column select **Limits**.
2. From the **Limits** page, select **Auto Limits** at the left bottom.

### Setting the Auto Limits for New Patient Switch

1. Access the **Setup** page in either of the following ways:
  - ◆ Select the **Alarm Setup** quick key → select the **Setup** tab.
  - ◆ Select the **Main Menu** quick key → from the **Alarm** column select **Setup**.
2. Set the **Auto Limits for New Patient** switch.

## Pausing Alarms/Pausing Alarm Tones

1. Select the **Main Menu** quick key → turn to the third page → from the **System** column select **Maintenance** → input the required password → select **Ok**.
2. Select the **Alarm** tab → select the **Pause/Reset** tab.
3. Set **Pause** to **Alarm Pause** or **Audio Pause**.

## Resetting Alarms

Pressing the **Alarm Reset** quick key to acknowledge the ongoing alarms and reset the alarm system.

## Accessing Help When Technical Alarms Occur

In the technical alarm list, alarm messages followed by **Detail** includes help information.

1. Select the technical alarm information area to enter the **Alarms** window.
2. Select the **Technical Alarms** tab.
3. Select the desired alarm.

## Monitoring ECG

### Choosing the ECG Lead Type

1. Select the ECG numeric area or waveform area to enter the **ECG** menu.
2. From the **ECG** page, select the **Setup** tab.
3. Set **Lead Set** according to the lead type you are going to use. The default lead type is **Auto**. In this case, the monitor automatically detects the used lead type.

### Checking Paced Status

1. Select the ECG numeric area or waveform area to enter the **ECG** menu.
2. From the **ECG** page, select the **Pacer** tab.
3. Set **Paced** to **Yes** or **No**.

### Enabling ST Monitoring

1. Select the ECG numeric area or waveform area to enter the **ECG** menu.
2. Select the **ST** tab → select the **Setup** tab.
3. Switch on **ST Analysis**.

### Enabling QT/QTc Interval Monitoring

1. Select the ECG numeric area or waveform area to enter the **ECG** menu.
2. Select the **QT** tab → select the **Setup** tab.
3. Switch on **QT Analysis**.

## Entering the 12-Lead Screen

1. Select the ECG numeric area or waveform area to enter the **ECG** menu.
2. From the bottom of the ECG page, select **12-Lead**.

You can also enter the 12-Lead screen by either of the following ways:

- Select the **Screen Setup** quick key → select **ECG 12-Lead**.
- Select **Main Menu** quick key → from the **Display** column select **Choose Screen** → select **ECG 12-Lead**.

## Initiating Resting 12-lead ECG Analysis

To initiate 12-Lead ECG analysis, select **Analyze** from the left bottom of the 12-Lead screen.

## Viewing the ECG 24h Summary

Choose one of the following ways to view the ECG 24h Summary:

- Select the **ECG 24h Sum** quick key.
- Select the **Main Menu** quick key → from the **CAA** column select **ECG 24h Summary**.

## Monitoring SpO<sub>2</sub>

### Showing/Hiding PI

1. Select the SpO<sub>2</sub> numeric area or waveform area to enter the **SpO2** menu.
2. Select the **Setup** tab.
3. Switch on or off **Display PI**.











### Showing/Hiding PR

1. Select the SpO<sub>2</sub> numeric area or waveform area to enter the **SpO2** menu.
2. Select the **PR** tab.
3. Select the **Setup** tab.
4. Switch on or off **Display PR**.



## Monitoring NIBP

### Starting or Stopping NIBP Measurement

Task	By Quick Key	From NIBP Menu
Start a manual measurement	<b>NIBP Start/Stop</b> quick key 	<b>Start NIBP</b> button
Start auto NIBP series	<b>NIBP Start/Stop</b> quick key 	<b>Setup</b> tab → set <b>Interval</b> → <b>Start NIBP</b> button
	<b>NIBP Measure</b> quick key  → select interval	
Start NIBP sequence measurement	<b>NIBP Measure</b> quick key  → <b>Sequence</b> menu.	<b>Sequence</b> tab → set <b>NIBP sequence</b> → select <b>Start NIBP</b> button
Start STAT measurement	<b>NIBP STAT</b> quick key 	<b>STAT</b> button
	<b>NIBP Measure</b> quick key  → <b>STAT</b>	
Stop the current NIBP measurements	<b>NIBP Start/Stop</b> quick key 	<b>Stop NIBP</b> button
End auto NIBP series or NIBP sequence	<b>Stop All</b> quick key 	<b>Stop All</b> button
Stop STAT measurement and end series	<b>NIBP Start/Stop</b> quick key 	<b>Stop NIBP</b> or <b>Stop All</b> button
	<b>NIBP STAT</b> quick key 	

### Setting the NIBP Interval

1. Select the NIBP numeric area to enter the **NIBP** menu.
2. Select the **Setup** tab.
3. Set **Interval**. Selecting **Manual** switches to manual mode.

## Viewing NIBP Analysis

1. Select the NIBP numeric area to enter the **NIBP** menu.
2. Select the **Setup** tab.
3. Select **Analysis >>**.

## Monitoring IBP

### Changing the Pressure Label

The pressure label is a unique identifier for each type of pressure. Therefore, you should select a proper pressure label for the source of the pressure you want to monitor.

To select the pressure label, follow this procedure:

1. Select an IBP numeric area or waveform area to enter the corresponding pressure menu.
2. Select the **Setup** tab.
3. Select the desired Label.

### Zeroing the IBP Transducer

1. Connect the IBP transducer, the IBP adapter cable and the module.
2. Turn off the three-way valve (the one close to the transducer) to the patient, in order to Vent the transducer to the atmospheric pressure.
3. Zero the transducer by any of the following ways:
  - ◆ Press the **Zero** hard key on the module.
  - ◆ Select the numeric area (such as the Art numeric area), and then select **Zero**.
  - ◆ Select the **IBP Zero** quick key.
4. After the zero calibration is completed, close the stopcock to the air and open the stopcock to the patient.

## Monitoring CO<sub>2</sub>

To prepare the CO<sub>2</sub> measurement, connect the watertrap and sample line as shown below.

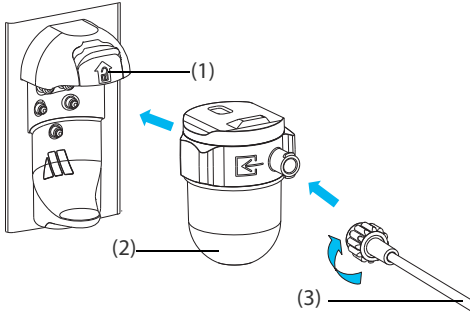

Sidestream CO<sub>2</sub> Module

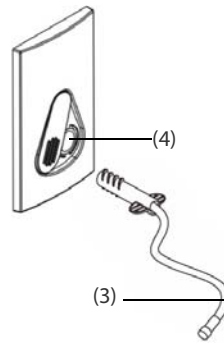

Microstream CO<sub>2</sub> Module

- (1) Watertrap receptacle
- (2) Watertrap
- (3) Sample line
- (4) Sample line connector

## Reviewing Trends

To review trends, enter the **Review** window by any of the following ways:

- Select the **Review** quick key.
- Select the **Main Menu** quick key → from the **Review** column select one option.

## Early Warning Score (EWS)

Choose any of the following ways to access the EWS window:

- Select the EWS parameter area
- Select the **EWS** quick key.
- Select the **Screen Setup** quick key → select the **Choose Screen** tab → select **EWS**.
- Select the **Main Menu** quick key → from the **CAA** column select **EWS**.

## Cleaning the Monitor

Clean your equipment on a regular basis. Before cleaning the equipment, consult your hospital's regulations for cleaning the equipment.

To clean the equipment, follow this procedure:

1. Dampen a soft lint-free cloth with water or ethanol (70%).
2. Wring excess liquid from the cloth.
3. Wipe the display screen of the monitor.

4. Wipe the external surface of the monitor with the damp cloth, avoiding the connectors and metal parts.
5. Dry the surface with a clean cloth. Allow the equipment air dry in a ventilated and cool place.

## Disinfecting the Monitor

Disinfect the equipment as required in your hospital's servicing schedule. Cleaning the equipment before disinfecting is recommended. Always dilute and use disinfectants according to the manufacturer's instructions. The following table lists approved disinfectants:

Product Name	Product Type	Manufacturer
Alpet® D2 Surface Sanitizing Wipes	Wipes	BEST SANITIZERS INC™.
CIDEX® OPA	Liquid	Gilag GmbH International Advanced Sterilization products
Clorox Dispatch® Hospital Cleaner Disinfectant Towels with Bleach	Wipes	Clorox professional products company
Clorox Healthcare® Bleach Germicidal Wipes	Wipes	Clorox professional products company
Clorox Healthcare® Hydrogen Peroxide Cleaner Disinfectant Wipes	Wipes	Clorox professional products company
Diversey Oxivir® TB Wipes	Wipes	Diversey Inc
Metrex CaviCide1™	Liquid, spray	METERX® RESEARCH
Metrex CaviWipes™	Wipes	METERX® RESEARCH
PDI Sani-Cloth® AF3 Germicidal Disposable Wipe	Wipes	PDI Inc.
PDI Sani-Cloth® Bleach Germicidal Disposable Wipe	Wipes	PDI Inc.
PDI Sani-Cloth® HB Germicidal Disposable Wipe	Wipes	PDI Inc.
PDI Sani-Cloth® Plus Germicidal Disposable Cloth	Wipes	PDI Inc.
PDI Super Sani-Cloth® Germicidal Disposable Wipe	Wipes	PDI Inc.

<b>Product Name</b>	<b>Product Type</b>	<b>Manufacturer</b>
VIRAGUARD® Hospital Surface Disinfectant Towelette	Wipes	VERIDIEN corporation
Virex® II 256 (1:256)	Liquid	Diversey Inc
Virex® TB	Liquid, spray	Diversey Inc
JIAN ZHI SU Disinfectant Tablets	Tablet	Beijing ChangJiangMai Medical Science Technology Co. Ltd
JIAN ZHI SU Surface Disinfectant Spray	Liquid, spray	Beijing ChangJiangMai Medical Science Technology Co. Ltd
JIAN ZHI SU Disinfectant, Double-chain Quaternary Ammonium	Liquid	Beijing ChangJiangMai Medical Science Technology Co. Ltd
DIAN'ERKANG Surface Wipes	Wipes	Shanghai Likang Disinfectant Hi-Tech Co., Ltd
DIAN'ERKANG Surface Disinfectant	Liquid	Shanghai Likang Disinfectant Hi-Tech Co., Ltd
DIAN'ERKANG Disinfectant Spray	Liquid, spray	Shanghai Likang Disinfectant Hi-Tech Co., Ltd
Clinell® Universal Wipes	Wipes	GAMA Healthcare Ltd
Clinell® Sporocidal Wipes	Wipes	GAMA Healthcare Ltd
Tristel Duo™	Liquid, foam	Tristel solutions Limited
Tristel Jet	Liquid, spray	Tristel solutions Limited
Tristel Fuse For Surfaces, 196ppm	Liquid	Tristel solutions Limited
Surfanios Premium, 0.25%	Liquid	ANIOS LABORATORIES
Surfa 'safe	Liquid, spray	ANIOS LABORATORIES
Wip' Anios premium	Wipes	ANIOS LABORATORIES
Aniosurf ND premium, 0.25%	Liquid	ANIOS LABORATORIES
Mikrobac® Tissues	Wipes	BODE Chemie GmbH
Cleanisept® Wipes	Wipes	Dr. Schumacher GmbH
mikrozid® PAA Wipes	Wipes	Schülke & Mayr GmbH
mikrozid® Sensitive Wipes	Wipes	Schülke & Mayr GmbH
Ecolab Incidin® OxyWipe S	Wipes	Ecolab Deutschland GmbH
Glutaraldehyde, 2%	Liquid	/

<b>Product Name</b>	<b>Product Type</b>	<b>Manufacturer</b>
*Ethanol, 70%	Liquid	/
*Isopropanol, 70%	Liquid	/
*Sodium hypochlorite bleach, 0.5%	Liquid	/
*Hydrogen peroxide, 3%	Liquid	/
*Rely+On™ Virkon® High Level surface Disinfectant, 1%	Powder	Antec International Ltd
*1-Propanol, 50%	Liquid	/
*Descosept® forte	Liquid	Dr. Schumacher GmbH
*Descosept® AF	Liquid	Dr. Schumacher GmbH
*Dismozon® plus, 0.4%	Powder	BODE Chemie GmbH
*mikrozid® AF Wipes	Wipes	Schülke & Mayr GmbH
*Terralin® Liquid	Liquid	Schülke & Mayr GmbH
*Perform® Classic Concentrate OXY, 0.5%	Powder	Schülke & Mayr GmbH





Shanghai International Holding Corp. GmbH (Europe)  
Eiffestraße 80, 20537 Hamburg Germany

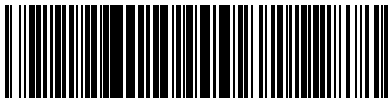

046-012996-00(2.0)